

# TIMKEN



## TIMKEN® TAPERED ROLLER BEARING CATALOG





## ABOUT THE TIMKEN COMPANY

The leading authority on tapered roller bearings, Timken today applies its deep knowledge of metallurgy, tribology and mechanical power transmission across a variety of bearings and related systems to improve reliability and efficiency of machinery and equipment all around the world. Timken (NYSE: TKR; [www.timken.com](http://www.timken.com)) engineers, manufactures and markets bearings, gear drives, belts, chain and related products, and offers a spectrum of powertrain rebuild and repair services.

To view more Timken catalogs, go to [www.timken.com/catalogs](http://www.timken.com/catalogs) for interactive versions, or to download a catalog app for your smart phone or mobile device.



## TAPERED ROLLER BEARING CATALOG INDEX

OVERVIEW.....	2
SHELF LIFE .....	3

### ENGINEERING

Tapered Roller Bearing Types and Cages .....	6
Determination of Applied Loads and Bearing Analysis Symbols ..	10
Metric System Tolerances .....	12
Inch System Tolerances .....	20
Tapered Roller Bearing Mounting Designs, Fitting Practices and Setting .....	26
Fitting Practice Tables .....	32
Operating Temperatures.....	47
Heat Generation and Dissipation .....	50
Torque .....	51
Lubrication .....	55

### TAPERED ROLLER BEARINGS

Part-Numbering Systems .....	66
------------------------------	----

#### Radial Roller Bearings

##### Single-Row Bearing Types

TS (pressed steel and pin-type).....	81
Metric .....	393
TSF (flanged cup) .....	433
TSL (DUO-FACE® Plus Seal) .....	505

##### Double-Row Bearing Type

TDO (single piece (double) outer ring and two single inner rings) .....	509
TDI (double-row double inner race) .....	609
TDIT (double-row double inner race with tapered bore) ..	640
TNA (double-row non-adjustable).....	647
TNASW (double-row, non-adjustable with lubricant slots) .	659
TNASWE (double-row, non-adjustable with lubricant slots and extended back face rib) .....	664
2TS-IM (two single-row assemblies, indirect mount) ..	670
2TS-DM (two single-row assemblies, direct mount) ...	698
2S (two single-row assemblies with snap ring spacer) ..	722
SR (two single row, SET-RIGHT™ assembly) .....	726

#### Tapered Roller Thrust Bearing

Part-Numbering Systems .....	736
TTHD (heavy duty) .....	737
TTHDFL (flat race) .....	738
TTVS (flat race, self-aligning) .....	740
TTSP (light-duty, with cage).....	741
TTC, TTCS, TTCL .....	744

<b>Auxiliary Parts</b> .....	747
------------------------------	-----

## **TIMKEN® TAPERED ROLLER BEARINGS - RELIABILITY, VERSATILITY, CHOICE**

Demanding applications call for reliable solutions. Improve your equipment's performance and reduce your downtime and maintenance costs by turning to Timken tapered roller bearings. When you purchase a Timken bearing, you're investing in a product that's designed with you in mind.

**Reliability.** Expert craftsmanship, well-equipped production facilities and an ongoing investment in technology ensure our products are synonymous with quality and reliability. Our tapered roller bearings stand up to extreme situations, including high-corrosive, high-temperature, vacuum or low-lubrication environments.

**Versatility.** Use Timken tapered roller bearings to help your equipment excel when it faces combined radial and thrust loads. Our bearings are uniquely designed to manage both types of loads on rotating shafts and in housings.

**Choice.** From single- to double- to four-row configurations to thrust, choose from nearly 26,000 product combinations to find the right bearing for your application.



### **DESIGN FEATURES**

Each tapered roller bearing contains four interdependent components: the cone (inner ring), the cup (outer ring), tapered rollers (rolling elements) and the cage (roller retainer).

Tapered angles allow our bearings to efficiently control a combination of radial and thrust loads. The steeper the outer ring angle, the greater ability the bearing has to handle thrust loads. To provide a true rolling motion of the rollers on the raceways, the extensions of the raceways and the tapered surfaces of the rollers come together at a common point, the apex, on the axis of rotation.



### **HOW TO USE THIS CATALOG**

We designed this catalog to help you find the Timken bearings best suited to your equipment needs and specifications.

The product tables list many of the bearing types that are specifically used in thrust positions. For other bearing types, please refer to the respective Timken product catalog reference.

Timken offers an extensive range of bearings and accessories in both imperial and metric sizes. For your convenience, size ranges are indicated in millimeters and inches. Contact your Timken engineer to learn more about our complete line for the special needs of your application.

This publication contains dimensions, tolerances and load ratings, as well as engineering sections describing mounting and fitting practices for shafts and housings, internal clearances, materials and other bearing features. It provides valuable assistance in the initial consideration of the type and characteristics of the bearings that may best suit your particular needs.

ISO and ANSI/ABMA, as used in this publication, refer to the International Organization for Standardization and the American National Standards Institute/American Bearing Manufacturers Association.



## ***SHELF LIFE AND STORAGE OF GREASE-LUBRICATED BEARINGS AND COMPONENTS***

To help you get the most value from our products, Timken provides guidelines for the shelf life of grease-lubricated ball and roller bearings, components and assemblies. Shelf life information is based on Timken and industry test data and experience.

### **SHELF LIFE**

Shelf life should be distinguished from lubricated bearing/component design life as follows:

Shelf life of the grease-lubricated bearing/component represents the period of time prior to use or installation.

The shelf life is a portion of the anticipated aggregate design life. It is impossible to accurately predict design life due to variations in lubricant bleed rates, oil migration, operating conditions, installation conditions, temperature, humidity and extended storage.

**TIMKEN IS NOT RESPONSIBLE FOR THE SHELF LIFE OF ANY BEARING/COMPONENT LUBRICATED BY ANOTHER PARTY.**

### **European REACH compliance**

Timken lubricants, greases and similar products sold in standalone containers or delivery systems are subject to the European REACH (Registration, Evaluation, Authorization and Restriction of CHemicals) directive. For import into the European Union, Timken can sell and provide only those lubricants and greases that are registered with ECHA (European CHemical Agency). For further information, please contact your Timken engineer.

### **STORAGE**

Timken suggests the following storage guidelines for our finished products (bearings, components and assemblies, referred to as “products”):

- Unless directed otherwise by Timken, products should be kept in their original packaging until they are ready to be placed into service.
- Do not remove or alter any labels or stencil markings on the packaging.
- Products should be stored in such a way that the packaging is not pierced, crushed or otherwise damaged.
- After a product is removed from its packaging, it should be placed into service as soon as possible.
- When removing a product that is not individually packaged from a bulk pack container, the container should be resealed immediately after the product is removed.
- The storage area temperature should be maintained between 0° C (32° F) and 40° C (104° F); temperature fluctuations should be minimized.
- The relative humidity should be maintained below 60 percent and the surfaces should be dry.
- The storage area should be kept free from airborne contaminants such as, but not limited to, dust, dirt, harmful vapors, etc.
- The storage area should be isolated from undue vibration.
- Extreme conditions of any kind should be avoided.

Due to the fact that Timken is not familiar with your particular storage conditions, we strongly suggest following these guidelines. However, you may be required by circumstances or applicable government requirements to adhere to stricter storage requirements.

Most bearing components typically ship protected with a corrosion-preventive compound that is not a lubricant. These components may be used in oil-lubricated applications without removal of the corrosion-preventive compound. When using some specialized grease lubrications, we advise you to remove the corrosion-preventive compound before packing the bearing components with suitable grease.

Be careful in selecting lubrication, however, since different lubricants are often incompatible.

When you receive a bearing shipment, do not remove products from their packaging until they are ready for mounting so they do not become corroded or contaminated.

Store bearings and bearing housings in an appropriate atmosphere so they remain protected for the intended period.

**⚠ WARNING**

***Failure to observe the following warnings could create a risk of death or serious injury.***

Never spin a bearing with compressed air.  
The components may be forcefully expelled.

Proper maintenance and handling practices are critical.  
Always follow installation instructions and  
maintain proper lubrication

**Warnings for this product line are in this catalog  
and posted on [http://www.timken.com/en-us/products/  
warnings/Pages/default.aspx](http://www.timken.com/en-us/products/warnings/Pages/default.aspx)**

This information is not intended to substitute for the specific  
recommendations of your equipment suppliers.

Every reasonable effort has been made to ensure the accuracy  
of the information contained in this writing, but no liability is  
accepted for errors, omissions or for any other reason.

**DISCLAIMER**

***This catalog is provided solely to give you analysis tools and data to assist you in your product selection. Product performance is affected by many factors beyond the control of Timken. Therefore, you must validate the suitability and feasibility of all product selections.***

***Timken products are sold subject to Timken terms and conditions of sale, which include our limited warranty and remedy. You can find these at [http://www.timken.com/en-us/purchase/Pages/  
TermsandConditionsofSale.aspx](http://www.timken.com/en-us/purchase/Pages/TermsandConditionsofSale.aspx).***

***Please consult with your Timken engineer for more information and assistance. Every reasonable effort has been made to ensure the accuracy of the information in this writing, but no liability is accepted for errors, omissions or for any other reason.***



## **ENGINEERING**

The following topics are covered within this engineering section:

- Tapered roller bearing design types.
- Cage design types.
- Fitting practice and mounting recommendations.
- Lubrication recommendations.

This engineering section is not intended to be comprehensive, but does serve as a useful guide in tapered roller bearing selection.

To view the complete engineering catalog, please visit [www.timken.com](http://www.timken.com). To order the catalog, please contact your Timken engineer and request a copy of the Timken Engineering Manual, order number 10424.



*To view more Timken catalogs, go to [www.timken.com/catalogs](http://www.timken.com/catalogs) for interactive versions, or to download a catalog app for your smart phone or mobile device scan the QR code or go to [timkencatalogs.squawqr.com](http://timkencatalogs.squawqr.com).*

## TAPERED ROLLER BEARINGS TYPES AND CAGES

### SINGLE-ROW BEARINGS

#### TS - SINGLE-ROW

This is the basic and the most widely used type of tapered roller bearing. It consists of the inner-ring assembly and the outer ring. It is usually fitted as one of an opposing pair. During equipment assembly, single-row bearings can be “set” to the required clearance (endplay) or preload condition to optimize performance.



Fig. 1. Single-row TS bearing.

#### TSF - SINGLE-ROW, WITH FLANGED OUTER RING

The TSF type is a variation on the basic single-row bearing. TSF bearings have a flanged outer ring to facilitate axial location and accurately aligned seats in a through-bored housing.



Fig. 2. Single-row TSF bearing with flanged outer ring.

### DOUBLE-ROW BEARINGS

#### TDO - DOUBLE OUTER RING

This has a one-piece (double) outer ring and two single inner rings. It is usually supplied complete with an inner-ring spacer as a pre-set assembly. This configuration gives a wide effective bearing spread and is frequently chosen for applications where overturning moments are a significant load component. TDO bearings can be used in fixed (locating) positions or allowed to float in the housing bore, for example, to compensate for shaft expansion. TDOCD outer rings also are available in most sizes. These outer rings have holes in the O.D. that permit the use of pins to prevent outer ring rotation in the housing.



Fig. 3. Double-row TDO bearing.

#### TDI - DOUBLE INNER RING

#### TDIT - DOUBLE INNER RING WITH TAPERED BORE

Both comprise a one-piece (double) inner ring and two single outer rings. They are usually supplied complete with an outer-ring spacer as a pre-set assembly. TDI and TDIT bearings can be used at fixed (locating) positions on rotating shaft applications. For rotating housing applications, the double inner ring of type TDI can be used to float on the stationary shaft. Type TDIT has a tapered bore to facilitate removal when an interference fit is essential, yet regular removal is required.



Fig. 4. Double-row, double-inner-ring bearings.

**TNA - NON-ADJUSTABLE**

**TNASW - NON-ADJUSTABLE WITH LUBRICANT SLOTS**

**TNASWE - NON-ADJUSTABLE WITH LUBRICANT SLOTS AND EXTENDED BACK FACE RIB**

These three bearing types are similar to the TDO with a one-piece (double) outer ring and two single inner rings. The inner-ring front faces are extended so they abut, eliminating the need for a separate inner-ring spacer. Supplied with a built-in clearance to give a standard setting range, these bearings provide a solution for many fixed or floating bearing applications where optimum simplicity of assembly is required.

Types TNASW and TNASWE are variations having chamfers and slots on the front face of the inner ring to provide lubrication through the shaft. Type TNASWE have extended back face ribs on the inner rings which are ground on the O.D. to allow for the use of a seal or stamped closure. These designs are typically used on stationary shaft applications.



Fig. 5. Double-row, non-adjustable bearings.

## SPACER ASSEMBLIES

Any two single-row bearings (type TS) can be supplied as a double-row, pre-set, ready-to-fit assembly by the addition of spacers, machined to pre-determined dimensions and tolerances.

Spacer assemblies are provided in two types: "2S" and "SR". This concept can be applied to produce custom-made double-row bearings to suit specific applications. In addition to providing a bearing that automatically gives a pre-determined setting at assembly without the need for a manual setting, it is possible to modify the assembly width to suit an application, simply by varying the spacer widths.

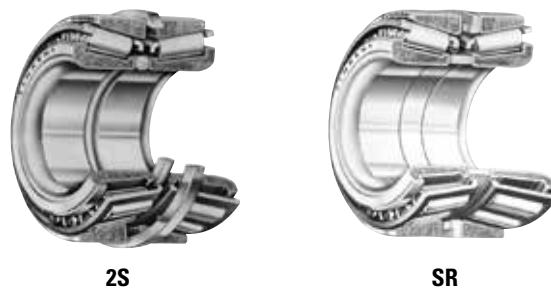


Fig. 6. Spacer assemblies.

### 2S - TWO SINGLE-ROW ASSEMBLY

Often referred to as snap-ring assemblies, type 2S consist of two basic single-row bearings (type TS). They are supplied complete with inner-ring and outer-ring spacers to give a pre-determined bearing setting when assembled. Type 2S have a specified setting range to suit the duty of the application. They have an inner-ring spacer and a snap-ring, which also serves as the outer-ring spacer, to give axial location in a through-bored housing.

### SR - SET-RIGHT™ ASSEMBLY

Type SR are made to a standard setting range, based on Timken's SET-RIGHT™ automated setting technique suitable for most industrial applications. They have two spacers and an optional snap-ring that may be used for axial location. Because both types are made up of popular sizes of single-row bearings, they provide a low-cost option for many applications.

There are two basic mounting arrangements for spacer assemblies.

- **Type 2TS-IM (indirect mounting)**

These consist of two single-row bearings with an inner-ring and outer-ring spacer. In some applications, the outer-ring spacer is replaced by a shoulder in the bearing housing.

- **Type 2TS-DM (direct mounting)**

These consist of two single-row bearings, with inner rings abutting and an outer-ring spacer. They are generally used at fixed (locating) positions on rotating shaft applications.

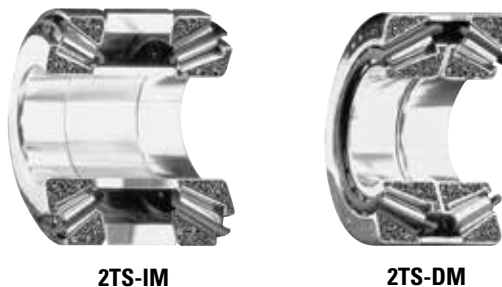


Fig. 7. Basic spacer assemblies.



## TAPERED ROLLER BEARING CAGES

### STAMPED-STEEL CAGES

The most common type of cage used for tapered roller bearings is the stamped-steel cage. These cages are mass produced from low-carbon sheet steel using a series of cutting, forming and punching operations. These cages can be used in high temperature and harsh lubricant environments.



Fig. 8. Stamped-steel cage.

### POLYMER CAGES

Cages for tapered roller bearings made of polymer material are used primarily for pre-greased and sealed package designs. The most common polymer materials used are Nylon thermoplastics with glass reinforcement. Polymer cages can be mass produced in large quantities and offer more design flexibility than stamped-steel types. Polymer cages are lightweight and easy to assemble. In some instances, increased bearing rating can be achieved by allowing one or two extra rollers in the bearing complement. Care should be exercised when using aggressive lubricants with EP (extreme-pressure) additives in combination with elevated temperatures greater than 107° C (225° F).

### MACHINED CAGES

Machined cages for tapered roller bearings are robust in design and are suited for high-speed and high-load applications. Machined cages use alloy steels and are produced through milling and broaching operations. Assembly does not require a close-in operation and rollers can be retained using nibs or staking. Oil holes also can be easily added for extra lubrication for demanding applications. Some designs are silver plated for special applications.

### PIN-TYPE CAGES

Tapered roller bearing pin-type cages retain the rolling elements by the use of a pin located through an axial hole in the center of the roller. Pin-type cages for tapered roller bearings consist of two rings with roller pins attached by screw threads at one end and welding at the other end. These types of cages are primarily used for larger tapered roller bearing designs (greater than 400 mm [15.7480 in.] O.D.). Pin-type cages are machined out of steel and typically allow for an increased number of rolling elements. Pin-type cages are restricted to low-speed applications (less than 20 m/sec [4000 ft/min] rib speed).

## METRIC SYSTEM TOLERANCES

Tapered bearings are manufactured to a number of specifications with each having classes that define tolerances on dimensions such as bore, O.D., width and runout. Metric bearings have been manufactured to corresponding standard negative tolerances.

Boundary dimension tolerances for tapered roller bearing usage are listed in the following tables. These tolerances are provided for use in selecting bearings for general applications in conjunction with the bearing mounting and fitting practices offered in later sections.

The following table summarizes the different specifications and classes for tapered roller bearings.

**TABLE 1. BEARING SPECIFICATIONS AND CLASSES**

System	Specification	Bearing Type	Standard Bearing Class		Precision Bearing Class			
Metric	Timken	Tapered Roller Bearings	K	N	C	B	A	AA
	ISO/DIN	All Bearing Types	P0	P6	P5	P4	P2	-
	ABMA	Tapered Roller Bearings	K	N	C	B	A	-
Inch	Timken	Tapered Roller Bearings	4	2	3	0	00	000
	ABMA	Tapered Roller Bearings	4	2	3	0	00	-

# DETERMINATION OF APPLIED LOADS AND BEARING ANALYSIS

## SUMMARY OF SYMBOLS USED TO DETERMINE APPLIED LOADS AND BEARING ANALYSIS

Symbol	Description	Units (Metric/Inch System)	Symbol	Description	Units (Metric/Inch System)
a	Axial Distance from Inner Ring Backface to Effective Load Center	mm, in.	D <sub>mW</sub>	Effective Working Diameter of the Worm	mm, in.
a <sub>1</sub>	Reliability Life Factor	unitless	D <sub>pG</sub>	Pitch Diameter of the Gear	mm, in.
a <sub>2</sub>	Material Life Factor	unitless	D <sub>pP</sub>	Pitch Diameter of the Pinion	mm, in.
a <sub>3</sub>	Operating Condition Life Factor	unitless	D <sub>pW</sub>	Pitch Diameter of the Worm	mm, in.
a <sub>3d</sub>	Debris Life Factor	unitless	e	Life Exponent	unitless
a <sub>3k</sub>	Load Zone Life Factor	unitless	e	Limiting Value of F <sub>a</sub> /F <sub>r</sub> for the Applicability of Different Values of Factors X and Y	unitless
a <sub>3l</sub>	Lubrication Life Factor	unitless	E	Free Endplay	mm, in.
a <sub>3p</sub>	Low-Load Life Factor	unitless	f	Lubricant Flow Rate	L/min, U.S. pt/min
a <sub>e</sub>	Effective Bearing Spread	mm, in.	f <sub>0</sub>	Viscous Dependent Torque Coefficient	unitless
A, B, ...	Bearing Position (used as subscripts)	unitless	f <sub>1</sub>	Load Dependent Torque Coefficient	unitless
B	Outer Ring Width	mm, in.	f <sub>b</sub>	Belt or Chain Pull	N, lbf
B <sub>1</sub>	Inner Ring Width	mm, in.	f <sub>n</sub>	Speed Factor	unitless
b	Tooth Length	mm, in.	f <sub>2</sub>	Combined Load Factor	unitless
c <sub>1</sub> , c <sub>2</sub>	Linear Distance (positive or negative).	mm, in.	f <sub>3</sub>	Combined Load Factor	unitless
C	Basic Dynamic Radial Load Rating of a Double-Row Bearing for an L <sub>10</sub> of One Million Revolutions	N, lbf	F	General Term for Force	N, lbf
C <sub>a90</sub>	Basic Dynamic Thrust Load Rating of a Single-Row Bearing for an L <sub>10</sub> of 90 Million Revolutions or 3000 Hours at 500 RPM	N, lbf	F <sub>1</sub> , F <sub>2</sub> , ..., F <sub>n</sub>	Magnitudes of Applied Force During a Loading Cycle	N, lbf
C <sub>0</sub>	Basic Static Radial Load Rating	N, lbf	F <sub>a</sub>	Applied Thrust (Axial) Load	N, lbf
C <sub>0a</sub>	Basic Static Axial Load Rating	N, lbf	F <sub>ai</sub>	Induced Thrust (Axial) Load Due to Radial Loading	N, lbf
C <sub>90</sub>	Basic Dynamic Radial Load Rating of a Single-Row Bearing for an L <sub>10</sub> of 90 Million Revolutions	N, lbf	F <sub>ac</sub>	Induced Thrust (Axial) Load Due to Centrifugal Loading	N, lbf
C <sub>90(2)</sub>	Basic Dynamic Radial Load Rating of a Double-Row Bearing for an L <sub>10</sub> of 90 Million Revolutions	N, lbf	F <sub>aG</sub>	Thrust Force on Gear	N, lbf
C <sub>a</sub>	Basic Dynamic Axial Load Rating	N, lbf	F <sub>aP</sub>	Thrust Force on Pinion	N, lbf
C <sub>g</sub>	Geometry Factor (used in a <sub>3l</sub> equation)	unitless	F <sub>aW</sub>	Thrust Force on Worm	N, lbf
C <sub>l</sub>	Load Factor (used in a <sub>3l</sub> equation)	unitless	F <sub>az</sub>	Allowable Axial Load	N, lbf
C <sub>j</sub>	Load Zone Factor (used in a <sub>3l</sub> equation)	unitless	F <sub>b</sub>	Belt or Chain Pull	N, lbf
C <sub>s</sub>	Speed Factor (used in a <sub>3l</sub> equation)	unitless	F <sub>β</sub>	Load Term for Torque Equation	N, lbf
C <sub>v</sub>	Viscosity Factor (used in a <sub>3l</sub> equation)	unitless	F <sub>c</sub>	Centrifugal Force	N, lbf
C <sub>gr</sub>	Grease Lubrication Factor (used in a <sub>3l</sub> equation)	unitless	F <sub>r</sub>	Applied Radial Load	N, lbf
C <sub>p</sub>	Specific Heat of Lubricant	J/(Kg - °C), BTU/(lbf - °F)	F <sub>rh</sub>	Resultant Horizontal Force	N, lbf
C <sub>t</sub>	Basic Thrust Dynamic Load Rating	N, lbf	F <sub>RS</sub>	Resultant Separating Force	N, lbf
d	Bearing Bore Diameter	mm, in.	F <sub>RV</sub>	Resultant Vertical Force	N, lbf
d	Ball Diameter	mm, in.	F <sub>S</sub>	Separating Force on Gear	N, lbf
d <sub>1</sub>	Spherical Diameter	mm, in.	F <sub>SG</sub>	Separating Force on Gear	N, lbf
d <sub>a</sub>	Shaft Shoulder Diameter	mm, in.	F <sub>SP</sub>	Separating Force on Pinion	N, lbf
d <sub>0</sub>	Mean Inner Ring Diameter	mm, in.	F <sub>SW</sub>	Separating Force on Worm	N, lbf
dc	Distance Between Gear Centers	mm, in.	F <sub>t</sub>	Tangential Force	N, lbf
dm	Mean Bearing Diameter	mm, in.	F <sub>te</sub>	Tractive Effort on Vehicle Wheels	N, lbf
d <sub>si</sub>	Shaft Inside Diameter	mm, in.	F <sub>tG</sub>	Tangential Force on Gear	N, lbf
D	Bearing Outside Diameter	mm, in.	F <sub>tP</sub>	Tangential Force on Pinion	N, lbf
D <sub>0</sub>	Tapered Roller Bearing Outer Ring Mean Raceway Diameter	mm, in.	F <sub>tW</sub>	Tangential Force on Worm	N, lbf
D <sub>h</sub>	Housing Outside Diameter	mm, in.	F <sub>w</sub>	Force of Unbalance	N, lbf
D <sub>m</sub>	Mean Diameter or Effective Working Diameter of a Sprocket, Pulley, Wheel or Tire	mm, in.	F <sub>WB</sub>	Weighted Average Load	N, lbf
D <sub>m</sub>	Tapered Roller Mean Large Rib Diameter	mm, in.	G	Gear (used as subscript)	unitless
D <sub>mG</sub>	Mean or Effective Working Diameter of the Gear	mm, in.	G <sub>1</sub>	Geometry Factor from Bearing Data Tables	unitless
D <sub>mP</sub>	Effective Working Diameter of the Pinion	mm, in.	G <sub>2</sub>	Geometry Factor from Bearing Data Tables	unitless
			H	Power	kW, hp
			H <sub>s</sub>	Housing Shoulder Inner Diameter	mm, in.
			HF <sub>s</sub>	Static Load Rating Adjustment Factor for Raceway Hardness	unitless
			i	Number of Rows of Rollers in a Bearing	unitless

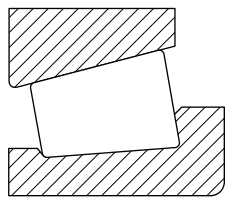
Symbol	Description	Units (Metric/Inch System)	Symbol	Description	Units (Metric/Inch System)
$i_B$	Number of Bearing Rows Taking Load	unitless	S	Shaft Diameter	mm, in.
k	Centrifugal Force Constant	lbf/RPM <sup>2</sup>	s	Shaft (used as subscript)	unitless
$k_1$	Bearing Torque Constant	unitless	$S_d$	Inner Ring Reference Face Runout	mm, in.
$k_4, k_5, k_6$	Dimensional Factor to Calculate Heat Generation	unitless	$S_D$	Outside Cylindrical Surface Runout	mm, in.
K	Tapered Roller Bearing K-factor; ratio of basic dynamic radial load rating to basic dynamic thrust rating in a single-row bearing	unitless	$S_{ea}$	Axial Runout of Outer Ring Assembly	mm, in.
K	Ball Bearing Constant Based on Geometry		$S_{ia}$	Axial Runout of Inner Ring Assembly	mm, in.
$K_1, K_2$	Super Precision K-Factors	unitless	$t_1, t_2, \dots, t_N$	Fractions of Time During a Loading Cycle	unitless
$K_{ea}$	Radial Runout of Outer Ring Assembly	mm, in.	T	Applied Thrust (Axial) Load	N, lbf
$K_o$	Outer Ring Contour Radius Expressed as a Decimal Fraction of the Ball Diameter	decimal fraction	$T_E$	Equivalent Thrust Load	N, lbf
$K_i$	Inner Ring Contour Radius Expressed as a Decimal Fraction of the Ball Diameter	decimal fraction	v	Vertical (used as subscript)	unitless
$K_{ia}$	Radial Runout of Inner Ring Assembly	mm, in.	V	Linear Velocity or Speed	km/h, mph
$K_N$	K-factor for Bearing #n	unitless	$V_{BS}$	Inner Ring Width Variation	mm, in.
$K_T$	Relative Thrust Load Factor – Ball Bearings	unitless	$V_{CS}$	Outer Ring Width Variation	mm, in.
$L_H$	Lead – Axial Advance of a Helix for One Complete Revolution	mm, in.	$V_r$	Rubbing, Surface or Tapered Roller Bearing Rib Velocity	m/s, fpm
L	Distance Between Bearing Geometric Center Lines	mm, in.	W	Worm (used as subscript)	unitless
$L_{10}$	Bearing Life	revolutions or hours	X	Dynamic Radial Load Factor	unitless
$L_f$	Life Factor	unitless	$X_0$	Static Radial Load Factor	unitless
m	Gearing Ratio	unitless	$Y, Y_1, Y_2, \dots$	Dynamic Thrust (Axial) Load Factor	unitless
M	Bearing Operating Torque	N-m, N-mm, lb.-in.	$Y_0$	Static Thrust (Axial) Load Factor	unitless
$M_0$	Moment	N-m, N-mm, lb.-in.	Z	Number of Rolling Elements	unitless
n	Bearing Operating Speed or General Term for Speed	rot/min, RPM	$\alpha_T$	Coefficient of Linear Expansion	mm/mm/°C, in./in./°F
$n_1, n_2, \dots, n_n$	Rotation Speeds During a Loading Cycle	rot/min, RPM	$\alpha_o$	Tapered Roller Bearing Half Included Outer Ring Raceway Angle	deg.
$N_A$	Reference Speed	rot/min, RPM	$\alpha$	Ball Bearing Nominal Contact Angle	deg.
$n_G$	Gear Operating Speed	rot/min, RPM	$\Delta T$	Temperature Difference Between Shaft/Inner Ring/Rollers and Housing/Outer Ring	°C, °F
$n_P$	Pinion Operating Speed	rot/min, RPM	$\Delta_{BS}$	Inner Ring Width Deviation	mm, in.
$n_W$	Worm Operating Speed	rot/min, RPM	$\Delta_{CS}$	Outer Ring Width Deviation	mm, in.
$N_c$	Number of Rotations of the Ball and Cage Assembly	unitless	$\Delta_{dmp}$	Deviation of Mean Bore Diameter in a Single Plane	mm, in.
$N_i$	Number of Rotations of the Inner Ring	unitless	$\Delta_{Dmp}$	Deviation of Mean Outside Diameter in a Single Plane	mm, in.
$N_G$	Number of Teeth in the Gear	unitless	$\delta s$	Interference Fit of Inner Ring on Shaft	mm, in.
$N_P$	Number of Teeth in the Pinion	unitless	$\delta h$	Interference Fit of Outer Ring in Housing	mm, in.
$N_S$	Number of Teeth in the Sprocket	unitless	$\eta$	Efficiency, Decimal Fraction	
$N_f$	Speed Factor	unitless	$\theta_1, \theta_2, \theta_3$	Gear Mesh Angles Relative to the Reference Plane	deg., rad
P	Pinion (used as subscript)	unitless	$\theta_i, \theta_o$	Oil Inlet or Outlet Temperature	°C, °F
$P_o$	Static Equivalent Load	N, lbf	$\lambda$	Worm Gear Lead Angle	deg.
$P_{oa}$	Static Equivalent Thrust (Axial)	N, lbf	$\mu$	Coefficient of Friction	unitless
$P_{or}$	Static Equivalent Radial Load	N, lbf	$\mu$	Lubricant Dynamic Viscosity	cP
$P_a$	Dynamic Equivalent Axial Load	N, lbf	v	Lubricant Kinematic Viscosity	cSt
$P_r$	Dynamic Equivalent Radial Load	N, lbf	$\sigma_o$	Approximate Maximum Contact Stress	MPa, psi
$P_{eq}$	Equivalent Dynamic Load	N, lbf	$\Phi_G$	Normal Tooth Pressure Angle for the Gear	deg.
Q	Generated Heat or Heat Dissipation Rate	W, BTU/min	$\Phi_P$	Normal Tooth Pressure Angle for the Pinion	deg.
$Q_{gen}$	Generated Heat	W, BTU/min	$\Psi_G$	Helix (Helical) or Spiral Angle for the Gear	deg.
$Q_{oil}$	Heat Dissipated by a Circulating Oil System	W, BTU/min	$\Psi_P$	Helix (Helical) or Spiral Angle for the Pinion	deg.
r	Radius to Center of Mass	mm, in.	$\rho$	Lubricant Density	kg/m <sup>3</sup> , lb./ft <sup>3</sup>
R	Percent Reliability, Used in the Calculation of the $a_1$ Factor	unitless	$\Upsilon_G$	Bevel Gearing – Gear Pitch Angle	deg.
RIC	Radial Internal Clearance	mm, in.	$\Upsilon_P$	Hypoid Gearing – Gear Root Angle	deg.
				Bevel Gearing – Pinion Pitch Angle	deg.
				Hypoid Gearing – Pinion Face Angle	deg.

## METRIC SYSTEM BEARINGS (ISO AND J PREFIX PARTS)

Timken manufactures metric system bearings to six tolerance classes. Classes K and N are often referred to as standard classes. Class N has more closely controlled width tolerances than K. Classes C, B, A and AA are precision classes. These

tolerances lie within those currently specified in ISO 492 with the exception of a small number of dimensions indicated in the tables. The differences normally have an insignificant effect on the mounting and performance of tapered roller bearings.

**TABLE 2. TAPERED ROLLER BEARING TOLERANCES – INNER RING BORE (Metric)**



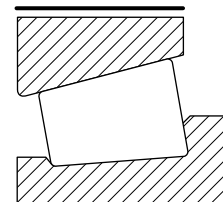
Bearing Types	Bore		Standard Bearing Class				Precision Bearing Class							
			K		N		C		B		A		AA	
	Over	Incl.	Max.	Min.	Max.	Min.	Max.	Min.	Max.	Min.	Max.	Min.	Max.	Min.
	mm	mm	mm	mm	mm	mm	mm	mm	mm	mm	mm	mm	mm	mm
	in.	in.	in.	in.	in.	in.	in.	in.	in.	in.	in.	in.	in.	in.
TS TSF SR <sup>(1)</sup>	10.000	18.000	0.000	-0.012	0.000	-0.012	0.000	-0.007	0.000	-0.005	0.000	-0.005	0.000	-0.005
	0.3937	0.7087	0.0000	-0.00047	0.0000	-0.00047	0.0000	-0.0002	0.0000	-0.0001	0.0000	-0.0001	0.0000	-0.0001
	18.000	30.000	0.000	-0.012	0.000	-0.012	0.000	-0.008	0.000	-0.006	0.000	-0.006	0.000	-0.006
	0.7087	1.1811	0.0000	-0.0005	0.0000	-0.0005	0.0000	-0.0003	0.0000	-0.0002	0.0000	-0.0002	0.0000	-0.0002
	30.000	50.000	0.000	-0.012	0.000	-0.012	0.000	-0.010	0.000	-0.008	0.000	-0.008	0.000	-0.008
	1.1811	1.9685	0.0000	-0.0005	0.0000	-0.0005	0.0000	-0.0004	0.0000	-0.0003	0.0000	-0.0003	0.0000	-0.0003
	50.000	80.000	0.000	-0.015	0.000	-0.015	0.000	-0.012	0.000	-0.009	0.000	-0.008	0.000	-0.008
	1.9685	3.1496	0.0000	-0.0006	0.0000	-0.0006	0.0000	-0.0005	0.0000	-0.0004	0.0000	-0.0003	0.0000	-0.0003
	80.000	120.000	0.000	-0.020	0.000	-0.020	0.000	-0.015	0.000	-0.010	0.000	-0.008	0.000	-0.008
	3.1496	4.7244	0.0000	-0.00079	0.0000	-0.00079	0.0000	-0.0006	0.0000	-0.0004	0.0000	-0.0003	0.0000	-0.0003
	120.000	180.000	0.000	-0.025	0.000	-0.025	0.000	-0.018	0.000	-0.013	0.000	-0.008	0.000	-0.008
	4.7244	7.0886	0.0000	-0.00098	0.0000	-0.00098	0.0000	-0.0007	0.0000	-0.0005	0.0000	-0.0003	0.0000	-0.0003
	180.000	250.000	0.000	-0.030	0.000	-0.030	0.000	-0.022	0.000	-0.015	0.000	-0.008	0.000	-0.008
	7.0886	9.8425	0.0000	-0.0012	0.0000	-0.0012	0.0000	-0.0009	0.0000	-0.0006	0.0000	-0.0003	0.0000	-0.0003
	250.000	265.000	0.000	-0.035	0.000	-0.035	0.000	-0.022	0.000	-0.015	0.000	-0.008	0.000	-0.008
	9.8425	10.4331	0.0000	-0.0014	0.0000	-0.0014	0.0000	-0.0009	0.0000	-0.0006	0.0000	-0.0003	0.0000	-0.0003
	265.000	315.000	0.000	-0.035	0.000	-0.035	0.000	-0.022	0.000	-0.015	0.000	-0.008	0.000	-0.008
	10.4331	12.4016	0.0000	-0.0014	0.0000	-0.0014	0.0000	-0.0009	0.0000	-0.0006	0.0000	-0.0003	0.0000	-0.0003
	315.000	400.000	0.000	-0.040	0.000	-0.040	0.000	-0.025	-	-	-	-	-	-
	12.4016	15.7480	0.0000	-0.0016	0.0000	-0.0016	0.0000	-0.0010	-	-	-	-	-	-
400.000	500.000	0.000	-0.045	0.000	-0.045	0.000	-0.025	-	-	-	-	-	-	
15.7480	19.6850	0.0000	-0.0018	0.0000	-0.0018	0.0000	-0.0010	-	-	-	-	-	-	
500.000	630.000	0.000	-0.050	0.000	-0.050	0.000	-0.030	-	-	-	-	-	-	
19.6850	24.8031	0.0000	-0.0020	0.0000	-0.0020	0.0000	-0.0012	-	-	-	-	-	-	
630.000	800.000	0.000	-0.080	-	-	0.000	-0.040	-	-	-	-	-	-	
24.8031	31.4961	0.0000	-0.0031	-	-	0.0000	-0.0014	-	-	-	-	-	-	
800.000	1000.000	0.000	-0.100	-	-	0.000	-0.050	-	-	-	-	-	-	
31.4961	39.3701	0.0000	-0.0040	-	-	0.0000	-0.0020	-	-	-	-	-	-	
1000.000	1200.000	0.000	-0.130	-	-	0.000	-0.060	-	-	-	-	-	-	
39.3701	47.2441	0.0000	-0.0051	-	-	0.0000	-0.0024	-	-	-	-	-	-	
1200.000	1600.000	0.000	-0.150	-	-	0.000	-0.080	-	-	-	-	-	-	
47.2441	62.9921	0.0000	-0.0065	-	-	0.0000	-0.0031	-	-	-	-	-	-	
1600.000	2000.000	0.000	-0.200	-	-	-	-	-	-	-	-	-	-	
62.9921	78.7402	0.0000	-0.0079	-	-	-	-	-	-	-	-	-	-	
2000.000	-	0.000	-0.250	-	-	-	-	-	-	-	-	-	-	
78.7402	-	0.0000	-0.0098	-	-	-	-	-	-	-	-	-	-	

<sup>(1)</sup>SR assemblies are manufactured to tolerance class N only.



TABLE 3. TAPERED ROLLER BEARING TOLERANCES – OUTER RING OUTSIDE DIAMETER (Metric)

Bearing Type	O.D.		Standard Bearing Class				Precision Bearing Class							
			K		N		C		B		A		AA	
	Over	Incl.	Max.	Min.	Max.	Min.	Max.	Min.	Max.	Min.	Max.	Min.	Max.	Min.
	mm	mm	mm	mm	mm	mm	mm	mm	mm	mm	mm	mm	mm	mm
	in.	in.	in.	in.	in.	in.	in.	in.	in.	in.	in.	in.	in.	in.
TS TSF SR <sup>(1)</sup>	10.000	18.000	0.000	-	-	-	-	-	-	-	0.000	-0.008	0.000	-0.008
	0.3937	0.7087	0.0000	-	-	-	-	-	-	-	0.0000	-0.0003	0.0000	-0.0003
	18.000	30.000	0.000	-0.012	0.000	-0.012	0.000	-0.008	0.000	-0.0006	0.000	-0.008	0.000	-0.008
	0.7087	1.1811	0.0000	-0.00047	0.0000	-0.00047	0.0000	-0.0003	0.0000	-0.0002	0.0000	-0.0003	0.0000	-0.0003
	30.000	50.000	0.000	-0.014	0.000	-0.014	0.000	-0.009	0.000	-0.007	0.000	-0.008	0.000	-0.008
	1.1811	1.9685	0.0000	-0.0005	0.0000	-0.0005	0.0000	-0.0004	0.0000	-0.0003	0.0000	-0.0003	0.0000	-0.0003
	50.000	80.000	0.000	-0.016	0.000	-0.016	0.000	-0.011	0.000	-0.009	0.000	-0.008	0.000	-0.008
	1.9685	3.1496	0.0000	-0.0006	0.0000	-0.0006	0.0000	-0.0004	0.0000	-0.0004	0.0000	-0.0003	0.0000	-0.0003
	80.000	120.000	0.000	-0.018	0.000	-0.018	0.000	-0.013	0.000	-0.010	0.000	-0.008	0.000	-0.008
	3.1496	4.7244	0.0000	-0.0007	0.0000	-0.0007	0.0000	-0.0005	0.0000	-0.0004	0.0000	-0.0003	0.0000	-0.0003
	120.000	150.000	0.000	-0.020	0.000	-0.020	0.000	-0.015	0.000	-0.011	0.000	-0.008	0.000	-0.008
	4.7244	5.9055	0.0000	-0.00079	0.0000	-0.00079	0.0000	-0.0006	0.0000	-0.0004	0.0000	-0.0003	0.0000	-0.0003
	150.000	180.000	0.000	-0.025	0.000	-0.025	0.000	-0.018	0.000	-0.013	0.000	-0.008	0.000	-0.008
	5.9055	7.0866	0.0000	-0.00098	0.0000	-0.00098	0.0000	-0.0007	0.0000	-0.0005	0.0000	-0.0003	0.0000	-0.0003
	180.000	250.000	0.000	-0.030	0.000	-0.030	0.000	-0.020	0.000	-0.015	0.000	-0.008	0.000	-0.008
	7.0866	9.8425	0.0000	-0.0012	0.0000	-0.0012	0.0000	-0.0008	0.0000	-0.0006	0.0000	-0.0003	0.0000	-0.0003
	250.000	265.000	0.000	-0.035	0.000	-0.035	0.000	-0.025	0.000	-0.018	0.000	-0.008	0.000	-0.008
	9.8425	10.4331	0.0000	-0.0014	0.0000	-0.0014	0.0000	-0.0010	0.0000	-0.0007	0.0000	-0.0003	0.0000	-0.0003
	265.000	315.000	0.000	-0.035	0.000	-0.035	0.000	-0.025	0.000	-0.018	0.000	-0.008	0.000	-0.008
	10.4331	12.4016	0.0000	-0.0014	0.0000	-0.0014	0.0000	-0.0010	0.0000	-0.0007	0.0000	-0.0003	0.0000	-0.0003
315.000	400.000	0.000	-0.040	0.000	-0.040	0.000	-0.028	0.000	-0.020	-	-	-	-	
12.4016	15.7480	0.0000	-0.0016	0.0000	-0.0016	0.0000	-0.0011	0.0000	-0.0008	-	-	-	-	
400.000	500.000	0.000	-0.045	0.000	-0.045	0.000	-0.030	-	-	-	-	-	-	
15.7480	19.6850	0.0000	-0.0018	0.0000	-0.0018	0.0000	-0.0012	-	-	-	-	-	-	
500.000	630.000	0.000	-0.050	0.000	-0.050	0.000	-0.035	-	-	-	-	-	-	
19.6850	24.8031	0.0000	-0.0020	0.0000	-0.0020	0.0000	-0.0014	-	-	-	-	-	-	
630.000	800.000	0.000	-0.075	-	-	0.000	-0.040	-	-	-	-	-	-	
24.8031	31.4961	0.0000	-0.0030	-	-	0.0000	*0.0016	-	-	-	-	-	-	
800.000	1000.000	0.000	-0.100	-	-	0.000	-0.050	-	-	-	-	-	-	
31.4961	39.3701	0.0000	-0.0040	-	-	0.0000	-0.0020	-	-	-	-	-	-	
1000.000	1200.000	0.000	-0.130	-	-	0.000	-0.060	-	-	-	-	-	-	
39.3701	47.2441	0.0000	-0.0051	-	-	0.0000	-0.0024	-	-	-	-	-	-	
1200.000	1600.000	0.000	-0.165	-	-	0.000	-0.080	-	-	-	-	-	-	
47.2441	62.9921	0.0000	-0.0065	-	-	0.0000	-0.0031	-	-	-	-	-	-	
1600.000	2000.000	0.000	-0.200	-	-	-	-	-	-	-	-	-	-	
62.9921	78.7402	0.0000	-0.0079	-	-	-	-	-	-	-	-	-	-	
2000.000	-	0.000	-0.250	-	-	-	-	-	-	-	-	-	-	
78.7402	-	0.0000	-0.0098	-	-	-	-	-	-	-	-	-	-	



<sup>(1)</sup>SR assemblies are manufactured to tolerance class N only.

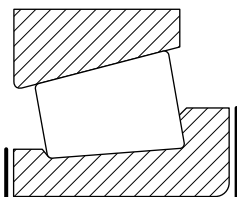
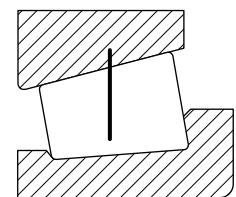


TABLE 4. TAPERED ROLLER BEARING TOLERANCES – INNER RING WIDTH (Metric)

Bearing Types	Bore		Standard Bearing Class				Precision Bearing Class							
			K		N		C		B		A		AA	
	Over	Incl.	Max.	Min.	Max.	Min.	Max.	Min.	Max.	Min.	Max.	Min.	Max.	Min.
	mm	mm	mm	mm	mm	mm	mm	mm	mm	mm	mm	mm	mm	mm
	in.	in.	in.	in.	in.	in.	in.	in.	in.	in.	in.	in.	in.	in.
TS TSF	10.000	50.000	0.000	-0.100	0.000	-0.050	0.000	-0.200	0.000	-0.200	0.000	-0.200	0.000	-0.200
	0.3937	1.9685	0.0000	-0.0040	0.0000	-0.0020	0.0000	-0.0079	0.0000	-0.0079	0.0000	-0.0079	0.0000	-0.0079
	50.000	120.000	0.000	-0.150	0.000	-0.050	0.000	-0.300	0.000	-0.300	0.000	-0.300	0.000	-0.300
	1.9685	4.7244	0.0000	-0.0059	0.0000	-0.0020	0.0000	-0.0118	0.0000	-0.0118	0.0000	-0.0118	0.0000	-0.0118
	120.000	180.000	0.000	-0.200	0.000	-0.050	0.000	-0.300	0.000	-0.300	0.000	-0.300	0.000	-0.300
	4.7244	7.0866	0.0000	-0.0079	0.0000	-0.0020	0.0000	-0.0118	0.0000	-0.0118	0.0000	-0.0118	0.0000	-0.0118
	180.000	250.000	0.000	-0.200	0.000	-0.050	0.000	-0.350	0.000	-0.350	0.000	-0.350	0.000	-0.350
	7.0866	9.8425	0.0000	-0.0079	0.0000	-0.0020	0.0000	-0.0138	0.0000	-0.0138	0.0000	-0.0138	0.0000	-0.0138
	250.000	265.000	0.000	-0.200	0.000	-0.050	0.000	-0.350	0.000	-0.350	0.000	-0.350	0.000	-0.350
	9.8425	10.4331	0.0000	-0.0079	0.0000	-0.0020	0.0000	-0.0138	0.0000	-0.0138	0.0000	-0.0138	0.0000	-0.0138
265.000	315.000	0.000	-0.200	0.000	-0.050	0.000	-0.350	0.000	-0.350	0.000	-0.350	0.000	-0.350	
10.4331	12.4016	0.0000	-0.0079	0.0000	-0.0020	0.0000	-0.0138	0.0000	-0.0138	0.0000	-0.0138	0.0000	-0.0138	
315.000	500.000	0.000	-0.250	0.000	-0.050	0.000	-0.350	-	-	-	-	-	-	
12.4016	19.6850	0.0000	-0.0098	0.0000	-0.0020	0.0000	-0.0138	-	-	-	-	-	-	
500.000	630.000	0.000	-0.250	0.000	-0.350	0.000	-0.350	-	-	-	-	-	-	
19.6850	24.8031	0.0000	-0.0098	0.0000	-0.0138	0.0000	-0.0138	-	-	-	-	-	-	
630.000	1200.000	0.000	-0.300	-	-	0.000	-0.350	-	-	-	-	-	-	
24.8031	47.2441	0.0000	-0.0118	-	-	0.0000	-0.0138	-	-	-	-	-	-	
1200.000	1600.000	0.000	-0.350	-	-	0.000	-0.350	-	-	-	-	-	-	
47.2441	62.9921	0.0000	-0.0138	-	-	0.0000	-0.0138	-	-	-	-	-	-	
1600.000	-	0.000	-0.350	-	-	-	-	-	-	-	-	-	-	
62.9921	-	0.0000	-0.0138	-	-	-	-	-	-	-	-	-	-	

TABLE 5. TAPERED ROLLER BEARING TOLERANCES – INNER RING STAND (Metric)

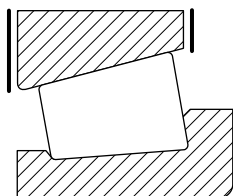
Bearing Types	Bore		Standard Bearing Class				Precision Bearing Class							
	Over	Incl.	K		N		C		B		A		AA	
	mm in.	mm in.	Max. in.	Min. in.	Max. in.	Min. in.	Max. in.	Min. in.	Max. in.	Min. in.	Max. in.	Min. in.	Max. in.	Min. in.
TS TSF	10.000 0.3937	80.000 3.1496	+0.100 +0.0039	0.000 0.0000	+0.050 +0.0020	0.000 0.0000	+0.100 +0.0039	-0.100 -0.0039						
	80.000 3.1496	120.000 4.7244	+0.100 +0.0039	-0.100 -0.0039	+0.050 +0.0020	0.000 0.0000	+0.100 +0.0039	-0.100 -0.0039						
	120.000 4.7244	180.000 7.0866	+0.150 +0.0059	-0.150 -0.0059	+0.050 +0.0020	0.000 0.0000	+0.100 +0.0039	-0.100 -0.0039	(1)	(1)	(1)	(1)	(1)	(1)
	180.000 7.0866	250.000 9.8425	+0.150 +0.0059	-0.150 -0.0059	+0.050 +0.0020	0.000 0.0000	+0.100 +0.0039	-0.150 -0.0059	(1)	(1)				
	250.000 9.8425	265.000 10.4331	+0.150 +0.0059	-0.150 -0.0059	+0.100 +0.0039	0.000 0.0000	+0.100 +0.0039	-0.150 -0.0059						
	265.000 10.4331	315.000 12.4016	+0.150 +0.0059	-0.150 -0.0059	+0.100 +0.0039	0.000 0.0000	+0.100 +0.0039	-0.150 -0.0059			-	-	-	-
	315.000 12.4016	400.000 15.7480	+0.200 +0.0079	-0.200 -0.0079	+0.100 +0.0039	0.000 0.0000	+0.150 +0.0059	-0.150 -0.0059	-	-	-	-	-	-
	400.000 15.7480	-	(1)	(1)	(1)	(1)	(1)	(1)	-	-	-	-	-	-



Inner Ring Stand. Inner Ring stand is a measure of the variation in Inner Ring raceway size, taper and roller diameter. This is checked by measuring the axial location of the reference surface of a master outer ring or other type gauge with respect to the reference Inner Ring face.

(1)These sizes manufactured as matched assemblies only.

TABLE 6. TAPERED ROLLER BEARING TOLERANCES – OUTER RING WIDTH (Metric)

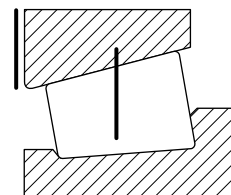


Bearing Types	O.D.		Standard Bearing Class				Precision Bearing Class							
			K		N		C		B		A		AA	
	Over	Incl.	Max.	Min. <sup>(1)</sup>	Max.	Min.	Max.	Min.	Max.	Min.	Max.	Min.	Max.	Min.
	mm	mm	mm	mm	mm	mm	mm	mm	mm	mm	mm	mm	mm	mm
	in.	in.	in.	in.	in.	in.	in.	in.	in.	in.	in.	in.	in.	in.
TS TSF	10.000	80.000	0.000	-0.150	0.000	-0.100	0.000	-0.150	0.000	-0.150	0.000	-0.150	0.000	-0.150
	0.3937	3.1496	0.0000	-0.0059	0.0000	-0.0040	0.0000	-0.0059	0.0000	-0.0059	0.0000	-0.0059	0.0000	-0.0059
	80.000	150.000	0.000	-0.200	0.000	-0.100	0.000	-0.200	0.000	-0.200	0.000	-0.200	0.000	-0.200
	3.1496	5.9055	0.0000	-0.0079	0.0000	-0.0040	0.0000	-0.0079	0.0000	-0.0079	0.0000	-0.0079	0.0000	-0.0079
	150.000	180.000	0.000	-0.200	0.000	-0.100	0.000	-0.250	0.000	-0.250	0.000	-0.250	0.000	-0.250
	5.9055	7.0866	0.0000	-0.0079	0.0000	-0.0040	0.0000	-0.0098	0.0000	-0.0098	0.0000	-0.0098	0.0000	-0.0098
	180.000	250.000	0.000	-0.250	0.000	-0.100	0.000	-0.250	0.000	-0.250	0.000	-0.250	0.000	-0.250
	7.0866	9.8425	0.0000	-0.0098	0.0000	-0.0040	0.0000	-0.0098	0.0000	-0.0098	0.0000	-0.0098	0.0000	-0.0098
	250.000	265.000	0.000	-0.250	0.000	-0.100	0.000	-0.300	0.000	-0.300	0.000	-0.300	0.000	-0.300
	9.8425	10.4331	0.0000	-0.0098	0.0000	-0.0040	0.0000	-0.0118	0.0000	-0.0118	0.0000	-0.0118	0.0000	-0.0118
	265.000	315.000	0.000	-0.250	0.000	-0.100	0.000	-0.300	0.000	-0.300	0.000	-0.300	0.000	-0.300
	10.4331	12.4016	0.0000	-0.0098	0.0000	-0.0040	0.0000	-0.0118	0.0000	-0.0118	0.0000	-0.0118	0.0000	-0.0118
315.000	400.000	0.000	-0.250	0.000	-0.100	0.000	-0.300	0.000	-0.300	-	-	-	-	
12.4016	15.7480	0.0000	-0.0098	0.0000	-0.0040	0.0000	-0.0118	0.0000	-0.0118	-	-	-	-	
400.000	500.000	0.000	-0.300	0.000	-0.100	0.000	-0.350	-	-	-	-	-	-	
15.7480	19.6850	0.0000	-0.0118	0.0000	-0.0040	0.0000	-0.0138	-	-	-	-	-	-	
500.000	800.000	0.000	-0.300	0.000	-0.100	0.000	-0.350	-	-	-	-	-	-	
19.6850	31.4961	0.0000	-0.0118	0.0000	-0.0040	0.0000	-0.0138	-	-	-	-	-	-	
800.000	1200.000	0.000	-0.350	-	-	0.000	-0.400	-	-	-	-	-	-	
31.4961	47.2441	0.0000	-0.0138	-	-	0.0000	-0.0157	-	-	-	-	-	-	
1200.000	1600.000	0.000	-0.400	-	-	0.000	-0.400	-	-	-	-	-	-	
47.2441	62.9921	0.0000	-0.0157	-	-	0.0000	-0.0157	-	-	-	-	-	-	
1600.000	-	0.000	-0.400	-	-	-	-	-	-	-	-	-	-	
62.9921	-	0.0000	-0.0157	-	-	-	-	-	-	-	-	-	-	

<sup>(1)</sup>These differ slightly from tolerances in ISO 492. These differences normally have an insignificant effect on the mounting and performance of tapered roller bearings. The 30000 series ISO bearings also are available with the above parameter according to ISO 492.

**TABLE 7. TAPERED ROLLER BEARING TOLERANCES – OUTER RING STAND (Metric)**

Bearing Types	O.D.		Standard Bearing Class				Precision Bearing Class							
			K		N		C		B		A		AA	
	Over	Incl.	Max.	Min.	Max.	Min.	Max.	Min.	Max.	Min.	Max.	Min.	Max.	Min.
	mm	mm	mm	mm	mm	mm	mm	mm	mm	mm	mm	mm	mm	mm
	in.	in.	in.	in.	in.	in.	in.	in.	in.	in.	in.	in.	in.	in.
TS TSF <sup>(1)</sup>	10.000	18.000	+0.100	0.000	+0.050	0.000	+0.100	-0.100						
	0.3937	0.7087	+0.0039	0.0000	+0.0020	0.0000	+0.0039	-0.0039						
	18.000	80.000	+0.100	0.000	+0.050	0.000	+0.100	-0.100						
	0.7087	3.1496	+0.0039	0.0000	+0.0020	0.0000	+0.0039	-0.0039						
	80.000	120.000	+0.100	-0.100	+0.050	0.000	+0.100	-0.100	(2)	(2)	(2)	(2)		
	3.1496	4.7244	+0.0039	-0.0039	+0.0020	0.0000	+0.0039	-0.0039						
	120.000	265.000	+0.200	-0.100	+0.100	0.000	+0.100	-0.150						
	4.7244	10.4331	+0.0079	-0.0039	+0.0039	0.0000	+0.0039	-0.0059						
265.000	315.000	+0.200	-0.100	+0.100	0.000	+0.100	-0.150							
10.4331	12.4016	+0.0079	-0.0039	+0.0039	0.0000	+0.0039	-0.0059							
315.000	400.000	+0.200	-0.200	+0.100	0.000	+0.100	-0.150			-	-	-	-	
12.4016	15.7480	+0.0079	-0.0079	+0.0039	0.0000	+0.0039	-0.0059							
315.000	400.000	+0.200	-0.200	+0.100	0.000	+0.150	-0.150	-	-	-	-	-	-	
12.4016	15.7480	+0.0079	-0.0079	+0.0040	0.0000	+0.0059	-0.0059							
400.000	-	(2)	(2)	(2)	(2)	(2)	(2)	-	-	-	-	-	-	
15.7480	-													



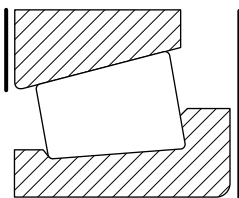
Outer Ring Stand. Outer ring stand is a measure of the variation in outer ring I.D. size and taper. This is checked by measuring the axial location of the reference surface of a master plug or other type gauge with respect to the reference face of the outer ring.

<sup>(1)</sup>Stand for flanged outer ring is measured from flange backface (seating face).

<sup>(2)</sup>These sizes manufactured as matched assemblies only.



TABLE 8. TAPERED ROLLER BEARING TOLERANCES – OVERALL BEARING WIDTH (Metric)



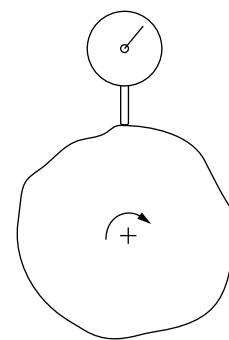
Bearing Types	Bore		Standard Bearing Class				Precision Bearing Class							
			K		N		C		B		A		AA	
	Over	Incl.	Max.	Min.	Max.	Min.	Max.	Min.	Max.	Min.	Max.	Min.	Max.	Min.
	mm	mm	mm	mm	mm	mm	mm	mm	mm	mm	mm	mm	mm	mm
	in.	in.	in.	in.	in.	in.	in.	in.	in.	in.	in.	in.	in.	in.
TS TSF <sup>(1)</sup>	10.000	80.000	+0.200	0.000	+0.100	0.000	+0.200	-0.200	+0.200	-0.200	+0.200	-0.200	+0.200	-0.200
	0.3937	3.1496	+0.0078	0.0000	+0.0039	0.0000	+0.0078	-0.0078	+0.0078	-0.0078	+0.0078	-0.0078	+0.0078	-0.0078
	80.000	120.000	+0.200	-0.200	+0.100	0.000	+0.200	-0.200	+0.200	-0.200	+0.200	-0.200	+0.200	-0.200
	3.1496	4.7244	+0.0078	-0.0078	+0.0039	0.0000	+0.0078	-0.0078	+0.0078	-0.0078	+0.0078	-0.0078	+0.0078	-0.0078
	120.000	180.000	+0.350	-0.250	+0.150	0.000	+0.350	-0.250	+0.200	-0.250	+0.200	-0.250	+0.200	-0.250
	4.7244	7.0866	+0.0137	-0.0098	+0.0059	0.0000	+0.0137	-0.0098	+0.0078	-0.0098	+0.0078	-0.0098	+0.0078	-0.0098
	180.000	250.000	+0.350	-0.250	+0.150	0.000	+0.350	-0.250	+0.200	-0.300	+0.200	-0.300	+0.200	-0.300
	7.0866	9.8425	+0.0137	-0.0098	+0.0059	0.0000	+0.0137	-0.0098	+0.0078	-0.0118	+0.0078	-0.0118	+0.0078	-0.0118
	250.000	265.000	+0.350	-0.250	+0.200	0.000	+0.350	-0.300	+0.200	-0.300	+0.200	-0.300	+0.200	-0.300
	9.8425	10.4331	+0.0137	-0.0098	+0.0078	0.0000	+0.0137	-0.0118	+0.0078	-0.0118	+0.0078	-0.0118	+0.0078	-0.0118
	265.000	315.000	+0.350	-0.250	+0.200	0.000	+0.350	-0.300	+0.200	-0.300	+0.200	-0.300	+0.200	-0.300
	10.4331	12.4016	+0.0137	-0.0098	+0.0078	0.0000	+0.0137	-0.0118	+0.0078	-0.0118	+0.0078	-0.0118	+0.0078	-0.0118
315.000	500.000	+0.400	-0.400	+0.200	0.000	+0.350	-0.300	-	-	-	-	-	-	
12.4016	19.6850	+0.0157	-0.0157	+0.0078	0.0000	+0.0137	-0.0118	-	-	-	-	-	-	
500.000	800.000	+0.400	-0.400	-	-	+0.350	-0.400	-	-	-	-	-	-	
19.6850	31.4961	+0.0157	-0.0157	-	-	+0.0137	-0.0157	-	-	-	-	-	-	
800.000	1000.000	+0.450	-0.450	-	-	+0.350	-0.400	-	-	-	-	-	-	
31.4961	39.3701	+0.0177	-0.0177	-	-	+0.0137	-0.0157	-	-	-	-	-	-	
1000.000	1200.000	+0.450	-0.450	-	-	+0.350	-0.450	-	-	-	-	-	-	
39.3701	47.2441	+0.0177	-0.0177	-	-	+0.0137	-0.0177	-	-	-	-	-	-	
1200.000	1600.000	+0.450	-0.450	-	-	+0.350	-0.500	-	-	-	-	-	-	
47.2441	62.9921	+0.0177	-0.0177	-	-	+0.0137	-0.0196	-	-	-	-	-	-	
1600.000		+0.450	-0.450	-	-	-	-	-	-	-	-	-	-	
62.9921		+0.0177	-0.0177	-	-	-	-	-	-	-	-	-	-	
SR <sup>(2)</sup>	180.000	250.000	0.000	-0.200	0.000	-0.050	0.000	-0.350	0.000	-0.350	0.000	-0.350	0.000	-0.350
	7.0866	9.8425	0.0000	-0.0079	0.0000	-0.0020	0.0000	-0.0138	0.0000	-0.0138	0.0000	-0.0138	0.0000	-0.0138

<sup>(1)</sup>For bearing type TSF, the tolerance applies to the dimension T1. Refer to the TSF data in this catalog.

<sup>(2)</sup>SR assemblies are manufactured to tolerance class N only.

**TABLE 9. TAPERED ROLLER BEARING TOLERANCES – RADIAL RUNOUT (Metric)**

Bearing Types	O.D.		Standard Bearing Class		Precision Bearing Class			
	Over	Incl.	K	N	C	B	A	AA
	mm in.	mm in.	mm in.	mm in.	mm in.	mm in.	mm in.	mm in.
TS TSF SR <sup>(1)</sup>	10.000 0.3937	18.000 0.7087	– –	– –	– –	– –	0.002 0.00008	0.001 0.00004
	18.000 0.7087	30.000 1.1811	0.018 0.0007	0.018 0.0007	0.005 0.0002	0.003 0.0001	0.002 0.00008	0.001 0.00004
	30.000 1.1811	50.000 1.9685	0.020 0.0008	0.020 0.0008	0.006 0.0002	0.003 0.0001	0.002 0.00008	0.001 0.00004
	50.000 1.9685	80.000 3.1496	0.025 0.0010	0.025 0.0010	0.006 0.0002	0.004 0.0002	0.002 0.00008	0.001 0.00004
	80.000 3.1496	120.000 4.7244	0.035 0.0014	0.035 0.0014	0.006 0.0002	0.004 0.0002	0.002 0.00008	0.001 0.00004
	120.000 4.7244	150.000 5.9055	0.040 0.0016	0.040 0.0016	0.007 0.0003	0.004 0.0002	0.002 0.00008	0.001 0.00004
	150.000 5.9055	180.000 7.0866	0.045 0.0018	0.045 0.0018	0.008 0.0003	0.004 0.0002	0.002 0.00008	0.001 0.00004
	180.000 7.0866	250.000 9.8425	0.050 0.0020	0.050 0.0020	0.010 0.0004	0.005 0.0002	0.002 0.00008	0.001 0.00004
	250.000 9.8425	265.000 10.4331	0.060 0.0024	0.060 0.0024	0.011 0.0004	0.005 0.0002	0.002 0.00008	0.001 0.00004
	265.000 10.4331	315.000 12.4016	0.060 0.0024	0.060 0.0024	0.011 0.0004	0.005 0.0002	0.002 0.00008	0.001 0.00004
	315.000 12.4016	400.000 15.7480	0.070 0.0028	0.070 0.0028	0.013 0.0005	0.005 0.0002	– –	– –
	400.000 15.7480	500.000 19.6850	0.080 0.0031	0.080 0.0031	– –	– –	– –	– –
	500.000 19.6850	630.000 24.8031	0.100 0.0039	– –	– –	– –	– –	– –
	630.000 24.8031	800.000 31.4961	0.120 0.0047	– –	– –	– –	– –	– –
	800.000 31.4961	1000.000 39.3701	0.140 0.0055	– –	– –	– –	– –	– –
	1000.000 39.3701	1200.000 47.2441	0.160 0.0063	– –	– –	– –	– –	– –
	1200.000 47.2441	1600.000 62.9921	0.180 0.0071	– –	– –	– –	– –	– –
	1600.000 62.9921	2000.000 78.7402	0.200 0.0079	– –	– –	– –	– –	– –
	2000.000 78.7402	– –	0.200 0.0079	– –	– –	– –	– –	– –

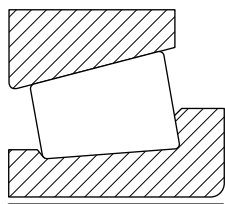


Runout. Runout is a measure of rotational accuracy expressed by Total Indicator Reading (T.I.R.). Total displacement is measured by an instrument sensing against a moving surface, or moved with respect to a fixed surface. A radial runout measurement includes both roundness errors and the centering error of the surface that the instrument head senses against.

<sup>(1)</sup>SR assemblies are manufactured to tolerance class N only.

# INCH SYSTEM TOLERANCES

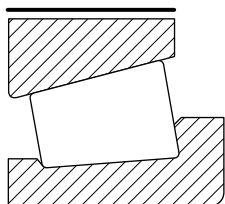
Inch system bearings are manufactured to a number of tolerance classes. Classes 4 and 2 are often referred to as standard classes. Classes 3, 0, 00 and 000 are precision classes. Inch system bearings conform to ABMA standard 19.2.



**TABLE 10. TAPERED ROLLER BEARING TOLERANCES – INNER RING BORE (Inch)**

Bearing Types	Bore		Standard Bearing Class				Precision Bearing Class							
			4		2		3		0		00		000	
	Over	Incl.	Max.	Min.	Max.	Min.	Max.	Min.	Max.	Min.	Max.	Min.	Max.	Min.
	mm	mm	mm	mm	mm	mm	mm	mm	mm	mm	mm	mm	mm	mm
	in.	in.	in.	in.	in.	in.	in.	in.	in.	in.	in.	in.	in.	in.
TS TSF TSL <sup>(1)</sup> TDI TDIT TDO TNA	0.000	76.200	+0.013	0.000	+0.013	0.000	+0.013	0.000	+0.013	0.000	+0.008	0.000	+0.008	0.000
	0.0000	3.0000	+0.0005	0.0000	+0.0005	0.0000	+0.0005	0.0000	+0.0005	0.0000	+0.0003	0.0000	+0.0003	0.0000
	76.200	304.800	+0.025	0.000	+0.025	0.000	+0.013	0.000	+0.013	0.000	+0.008	0.000	+0.008	0.000
	3.0000	12.0000	+0.0010	0.0000	+0.0010	0.0000	+0.0005	0.0000	+0.0005	0.0000	+0.0003	0.0000	+0.0003	0.0000
	304.800	609.600	–	–	+0.051	0.000	+0.025	0.000	–	–	–	–	–	–
	12.0000	24.0000	–	–	+0.0020	0.0000	+0.0010	0.0000	–	–	–	–	–	–
609.600	914.400	+0.076	0.000	–	–	+0.038	0.000	–	–	–	–	–	–	
24.0000	36.0000	+0.0030	0.0000	–	–	+0.0015	0.0000	–	–	–	–	–	–	
914.400	1219.200	+0.102	0.000	–	–	+0.051	0.000	–	–	–	–	–	–	
36.0000	48.0000	+0.0040	0.0000	–	–	+0.0020	0.0000	–	–	–	–	–	–	
1219.200	–	+0.127	0.000	–	–	+0.076	0.000	–	–	–	–	–	–	
48.0000	–	+0.0050	0.0000	–	–	+0.0030	0.0000	–	–	–	–	–	–	

<sup>(1)</sup>For TSL bearings these are the normal tolerances of inner ring bore. However, bore size can be slightly reduced at large end due to tight fit assembly of the seal on the rib. This should not have any effect on the performance of the bearing.



**TABLE 11. TAPERED ROLLER BEARING TOLERANCES – OUTER RING OUTSIDE DIAMETER (Inch)**

Bearing Types	O.D.		Standard Bearing Class				Precision Bearing Class							
			4		2		3		0		00		000	
	Over	Incl.	Max.	Min.	Max.	Min.	Max.	Min.	Max.	Min.	Max.	Min.	Max.	Min.
	mm	mm	mm	mm	mm	mm	mm	mm	mm	mm	mm	mm	mm	mm
	in.	in.	in.	in.	in.	in.	in.	in.	in.	in.	in.	in.	in.	in.
TS TSF TSL TDI TDIT TDO TNA TNASW TNASWE	0.000	304.800	+0.025	0.000	+0.025	0.000	+0.013	0.000	+0.013	0.000	+0.008	0.000	+0.008	0.000
	0.0000	12.0000	+0.0010	0.0000	+0.0010	0.0000	+0.0005	0.0000	+0.0005	0.0000	+0.0003	0.0000	+0.0003	0.0000
	304.800	609.600	+0.051	0.000	+0.051	0.000	+0.025	0.000	+0.013	0.000	+0.008	0.000	+0.008	0.000
	12.0000	24.0000	+0.0020	0.0000	+0.0020	0.0000	+0.0010	0.0000	+0.0005	0.0000	+0.0003	0.0000	+0.0003	0.0000
	609.600	914.400	+0.076	0.000	+0.076	0.000	+0.038	0.000	–	–	–	–	–	–
	24.0000	36.0000	+0.0030	0.0000	+0.0030	0.0000	+0.0015	0.0000	–	–	–	–	–	–
914.400	1219.200	+0.102	0.000	–	–	+0.051	0.000	–	–	–	–	–	–	
36.0000	48.0000	+0.0040	0.0000	–	–	+0.0020	0.0000	–	–	–	–	–	–	
1219.200	–	+0.127	0.000	–	–	+0.076	0.000	–	–	–	–	–	–	
48.0000	–	+0.0050	0.0000	–	–	+0.0030	0.0000	–	–	–	–	–	–	

TABLE 12. TAPERED ROLLER BEARING TOLERANCES – OUTER RING FLANGE (Inch)

Bearing Types	O.D.		Standard Bearing Class				Precision Bearing Class							
			4		2		3		0		00		000	
	Over	Incl.	Max.	Min.	Max.	Min.	Max.	Min.	Max.	Min.	Max.	Min.	Max.	Min.
	mm	mm	mm	mm	mm	mm	mm	mm	mm	mm	mm	mm	mm	mm
	in.	in.	in.	in.	in.	in.	in.	in.	in.	in.	in.	in.	in.	in.
TSF	0.000	304.800	+0.051	0.000	+0.052	0.000	+0.051	0.000	+0.051	0.000	+0.051	0.000	+0.051	0.000
	0.0000	12.0000	+0.0020	0.0000	+0.0020	0.0000	+0.0020	0.0000	+0.0020	0.0000	+0.0020	0.0000	+0.0020	0.0000
	304.800	609.600	+0.076	0.000	+0.076	0.000	+0.076	0.000	+0.051	0.000	+0.051	0.000	+0.051	0.000
	12.0000	24.0000	+0.0030	0.0000	+0.0030	0.0000	+0.0030	0.0000	+0.0020	0.0000	+0.0020	0.0000	+0.0020	0.0000
609.600	914.400	+0.102	0.000	+0.102	0.000	+0.102	0.000	-	-	-	-	-	-	
24.0000	36.0000	+0.0040	0.0000	+0.0040	0.0000	+0.0040	0.0000	-	-	-	-	-	-	
914.400	-	+0.127	0.000	-	-	+0.127	0.000	-	-	-	-	-	-	
36.0000	-	+0.0050	0.0000	-	-	+0.0050	0.0000	-	-	-	-	-	-	

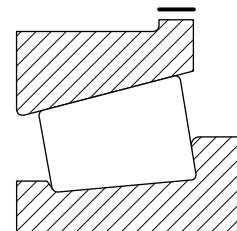


TABLE 13. TAPERED ROLLER BEARING TOLERANCES – INNER RING WIDTH (Inch)

Bearing Types	Bore		Standard Bearing Class				Precision Bearing Class							
			4		2		3		0		00		000	
	Over	Incl.	Max.	Min.	Max.	Min.	Max.	Min.	Max.	Min.	Max.	Min.	Max.	Min.
	mm	mm	mm	mm	mm	mm	mm	mm	mm	mm	mm	mm	mm	mm
	in.	in.	in.	in.	in.	in.	in.	in.	in.	in.	in.	in.	in.	in.
TS	All Sizes		+0.076	-0.254	+0.076	-0.254	+0.076	-0.254	+0.076	-0.254	+0.076	-0.254	+0.076	-0.254
TSF			+0.0030	-0.0100	+0.0030	-0.0100	+0.0030	-0.0100	+0.0030	-0.0100	+0.0030	-0.0100	+0.0030	-0.0100
TSL														
2S														
TDI														
TDIT														
TDO														

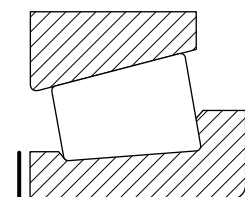
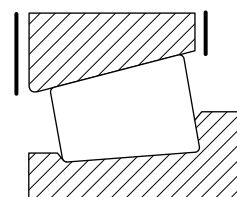
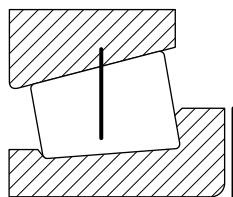


TABLE 14. TAPERED ROLLER BEARING TOLERANCES – OUTER RING WIDTH (Inch)

Bearing Types	O.D.		Standard Bearing Class				Precision Bearing Class							
			4		2		3		0		00		000	
	Over	Incl.	Max.	Min.	Max.	Min.	Max.	Min.	Max.	Min.	Max.	Min.	Max.	Min.
	mm	mm	mm	mm	mm	mm	mm	mm	mm	mm	mm	mm	mm	mm
	in.	in.	in.	in.	in.	in.	in.	in.	in.	in.	in.	in.	in.	in.
All Types	All Sizes		+0.051	-0.254	+0.051	-0.254	+0.051	-0.254	+0.051	-0.254	+0.051	-0.254	+0.051	-0.254
			+0.0020	-0.0100	+0.0020	-0.0100	+0.0020	-0.0100	+0.0020	-0.0100	+0.0020	-0.0100	+0.0020	-0.0100





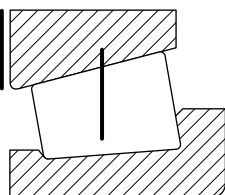
**Inner Ring Stand.** Inner Ring stand is a measure of the variation in Inner Ring raceway size, taper and roller diameter. This is checked by measuring the axial location of the reference surface of a master outer ring or other type gauge with respect to the reference Inner Ring face.

**TABLE 15. TAPERED ROLLER BEARING TOLERANCES – INNER RING STAND (Inch)**

Bearing Types	Bore		Standard Bearing Class				Precision Bearing Class							
	Over	Incl.	4		2		3		0		00		000	
	mm	mm	Max.	Min.	Max.	Min.	Max.	Min.	Max.	Min.	Max.	Min.	Max.	Min.
	in.	in.	in.	in.	in.	in.	in.	in.	in.	in.	in.	in.	in.	in.
TS TSF TSL 2S TDI <sup>(1)</sup> TDIT <sup>(1)</sup> TDO	0.000	101.600	+0.102	0.000	+0.102	0.000	+0.102	-0.102						
	0.0000	4.0000	+0.0040	0.0000	+0.0040	0.0000	+0.0040	-0.0040			(2)	(2)	(2)	(2)
	101.600	266.700	+0.152	-0.152	+0.102	0.000	+0.102	+0.102	(2)	(2)				
	4.0000	10.5000	+0.0060	-0.0060	+0.0040	0.0000	+0.0040	-0.0040						
	266.700	304.800	+0.152	-0.152	+0.102	0.000	+0.102	-0.102			-	-	-	-
	10.5000	12.0000	+0.0060	-0.0060	+0.0040	0.0000	+0.0040	-0.0040			-	-	-	-
	304.800	406.400	-	-	+0.178	-0.178	+0.178	-0.178	-	-	-	-	-	-
	12.0000	16.0000	-	-	+0.0070	-0.0070	+0.0070	-0.0070	-	-	-	-	-	-
	406.400	-	(2)	(2)	(2)	(2)	(2)	(2)	-	-	-	-	-	-
	16.0000	-							-	-	-	-	-	-

<sup>(1)</sup>For class 2, TDI and TDIT bearings with an inner ring bore of 101.600 to 304.800 mm (4.0000 to 12.0000 in.), the inner ring stand is  $\pm 0.102$  mm ( $\pm 0.0040$  in.).

<sup>(2)</sup>These sizes manufactured as matched assemblies only.



**Outer Ring Stand.** Outer ring stand is a measure of the variation in outer ring I.D. size and taper. This is checked by measuring the axial location of the reference surface of a master plug or other type gauge with respect to the reference face of the outer ring.

**TABLE 16. TAPERED ROLLER BEARING TOLERANCES – OUTER RING STAND (Inch)**

Bearing Types	Bore		Standard Bearing Class				Precision Bearing Class							
	Over	Incl.	4		2		3		0		00		000	
	mm	mm	Max.	Min.	Max.	Min.	Max.	Min.	Max.	Min.	Max.	Min.	Max.	Min.
	in.	in.	in.	in.	in.	in.	in.	in.	in.	in.	in.	in.	in.	in.
TS TSF <sup>(1)</sup> TSL TDI TDIT	0.000	101.600	+0.102	0.000	+0.102	0.000	+0.102	-0.102						
	0.0000	4.0000	+0.0040	0.0000	+0.0040	0.0000	+0.0040	-0.0040			(2)	(2)	(2)	(2)
	101.600	266.700	+0.203	-0.102	+0.102	0.000	+0.102	-0.102	(2)	(2)				
	4.0000	10.5000	+0.0080	-0.0040	+0.0040	0.0000	+0.0040	-0.0040						
	266.700	304.800	+0.203	-0.102	+0.102	0.000	+0.102	-0.102			-	-	-	-
	10.5000	12.0000	+0.0080	-0.0040	+0.0040	0.0000	+0.0040	-0.0040			-	-	-	-
	304.800	406.400	+0.203	-0.203	+0.203	-0.203	+0.203	-0.203	-	-	-	-	-	-
	12.0000	16.0000	+0.0080	-0.0080	+0.0080	-0.0080	+0.0080	-0.0080	-	-	-	-	-	-
	406.400	-	(2)	(2)	(2)	(2)	(2)	(2)	-	-	-	-	-	-
	16.0000	-							-	-	-	-	-	-

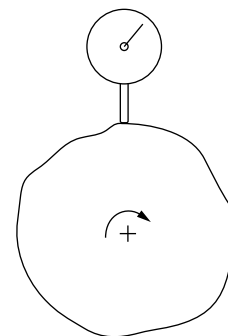
<sup>(1)</sup>Stand for flanged outer ring is measured from flange backface (seating face).

<sup>(2)</sup>These sizes manufactured as matched assemblies only.



**TABLE 17. TAPERED ROLLER BEARING TOLERANCES – RADIAL RUNOUT (Inch)**

Bearing Types	O.D.		Standard Bearing Class		Precision Bearing Class			
	Over	Incl.	4	2	3	0	00	000
	mm in.	mm in.	mm in.	mm in.	mm in.	mm in.	mm in.	mm in.
TS	<b>0.000</b> 0.0000	<b>266.700</b> 10.5000	<b>0.051</b> 0.0020	<b>0.038</b> 0.0015	<b>0.008</b> 0.0003	<b>0.004</b> 0.00015	<b>0.002</b> 0.000075	<b>0.001</b> 0.000040
TSF	<b>266.700</b>	<b>304.800</b>	<b>0.051</b>	<b>0.038</b>	<b>0.008</b>	<b>0.004</b>	<b>0.002</b>	<b>0.001</b>
TSL	10.5000	12.0000	0.0020	0.0015	0.0003	0.00015	0.000075	0.000040
2S								
TDI	<b>304.800</b>	<b>609.600</b>	<b>0.051</b>	<b>0.038</b>	<b>0.018</b>	–	–	–
TDIT	12.0000	24.0000	0.0020	0.0015	0.0007	–	–	–
TDO								
TNA	<b>609.600</b>	<b>914.400</b>	<b>0.076</b>	<b>0.051</b>	<b>0.051</b>	–	–	–
TNASW	24.0000	36.0000	0.0030	0.0020	0.0020	–	–	–
TNASWE	<b>914.400</b>	–	<b>0.076</b>	–	<b>0.076</b>	–	–	–
	36.0000	–	0.0030	–	0.0030	–	–	–



Runout. Runout is a measure of rotational accuracy expressed by Total Indicator Reading (T.I.R.). Total displacement is measured by an instrument sensing against a moving surface, or moved with respect to a fixed surface. A radial runout measurement includes both roundness errors and the centering error of the surface that the instrument head senses against.

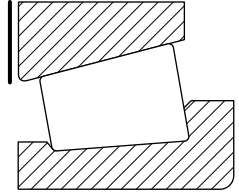


TABLE 18. TAPERED ROLLER BEARING TOLERANCES – OVERALL BEARING WIDTH (Inch)

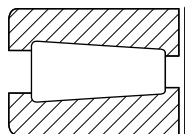
Bearing Types	Bore		O.D.		Standard Bearing Class				Precision Bearing Class							
	Over	Incl.	Over	Incl.	4		2		3		0		00		000	
					Max.	Min.	Max.	Min.	Max.	Min.	Max.	Min.	Max.	Min.	Max.	Min.
	mm in.	mm in.	mm in.	mm in.	mm in.	mm in.	mm in.	mm in.	mm in.	mm in.	mm in.	mm in.	mm in.	mm in.	mm in.	mm in.
TS TSF <sup>(1)</sup> TSL	0.000 0.0000	101.600 4.0000	-	-	+0.203 +0.0080	0.000 0.0000	+0.203 +0.0080	0.000 0.0000	+0.203 +0.0080	-0.203 -0.0080	+0.203 +0.0080	-0.203 -0.0080	+0.203 +0.0080	-0.203 -0.0080	+0.203 +0.0080	-0.203 -0.0080
	101.600 4.0000	304.800 12.0000	-	-	+0.356 +0.0140	-0.254 -0.0100	+0.203 +0.0080	0.000 0.0000	+0.203 +0.0080	-0.203 -0.0080	+0.203 +0.0080	-0.203 -0.0080	+0.203 +0.0080	-0.203 -0.0080	+0.203 +0.0080	-0.203 -0.0080
	304.800 12.0000	609.600 24.0000	0.000 0.0000	508.000 20.0000	-	-	+0.381 +0.0150	-0.381 -0.0150	+0.203 +0.0080	-0.203 -0.0080	-	-	-	-	-	-
	304.800 12.0000	609.600 24.0000	508.000 20.0000	-	-	-	-	+0.381 +0.0150	-0.381 -0.0150	+0.381 +0.0150	-0.381 -0.0150	-	-	-	-	-
	609.600 24.0000	-	-	-	+0.381 +0.0150	-0.381 -0.0150	-	-	+0.381 +0.0150	-0.381 -0.0150	-	-	-	-	-	-
TNA TNASW TNASWE	0.000 0.0000	127.000 5.0000	-	-	-	-	+0.254 +0.0100	0.000 0.0000	+0.254 +0.0100	0.000 0.0000	-	-	-	-	-	-
	127.000 5.0000	-	-	-	-	-	+0.762 +0.0300	0.000 0.0000	+0.762 +0.0300	0.000 0.0000	-	-	-	-	-	-
TDI TDIT TDO	0.000 0.0000	101.600 4.0000	-	-	+0.406 +0.0160	0.000 0.0000	+0.406 +0.0160	0.000 0.0000	+0.406 +0.0160	-0.406 -0.0160	+0.406 +0.0160	-0.406 -0.0160	+0.406 +0.0160	-0.406 -0.0160	+0.406 +0.0160	-0.406 -0.0160
	101.600 4.0000	304.800 12.0000	-	-	+0.711 +0.0280	-0.508 -0.0200	+0.406 +0.0160	-0.203 -0.0080	+0.406 +0.0160	-0.406 -0.0160	+0.406 +0.0160	-0.406 -0.0160	+0.406 +0.0160	-0.406 -0.0160	+0.406 +0.0160	-0.406 -0.0160
	304.800 12.0000	609.600 24.0000	0.000 0.0000	508.000 20.0000	-	-	+0.762 +0.0300	-0.762 -0.0300	+0.406 +0.0160	-0.406 -0.0160	-	-	-	-	-	-
	304.800 12.0000	609.600 24.0000	508.000 20.0000	-	-	-	+0.762 +0.0300	-0.762 -0.0300	+0.762 +0.0300	-0.762 -0.0300	-	-	-	-	-	-
	609.600 24.0000	-	-	-	+0.762 +0.0300	-0.762 -0.0300	-	-	+0.762 +0.0300	-0.762 -0.0300	-	-	-	-	-	-
2S	0.000 0.0000	101.600 4.0000	-	-	+0.457 +0.0180	-0.051 -0.0020	+0.457 +0.0180	-0.051 -0.0020	-	-	-	-	-	-	-	-

<sup>(1)</sup>For bearing type TSF, the tolerance applies to the dimension T<sub>1</sub>. Refer to the TSF data tables in this catalog.

TABLE 19. THRUST TAPERED ROLLER BEARING TOLERANCES – BORE (Inch)

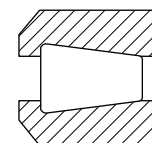
TTHD, TTHDFL, TTVS

TTC, TTSP – CLASS 4



TTHD, TTHDFL, TTVS

Bore		Bearing Class			
Range		Precision 2		Precision 3	
Over	Incl.	Over	Incl.	Max.	Min.
mm in.	mm in.	mm in.	mm in.	mm in.	mm in.
0.000 0.0000	304.800 12.0000	+0.025 +0.0010	0.000 0.0000	+0.013 +0.0005	0.000 0.0000
304.800 12.0000	609.600 24.0000	+0.051 0.0020	0.000 0.0000	+0.025 +0.0010	0.000 0.0000
609.600 24.0000	914.400 36.0000	+0.076 +0.0030	0.000 0.0000	+0.038 +0.0015	0.000 0.0000
914.400 36.0000	1219.200 48.0000	+0.102 +0.0040	0.000 0.0000	+0.051 0.0020	0.000 0.0000
1219.200 48.0000	–	+0.127 +0.0050	0.000 0.0000	+0.076 +0.030	0.000 0.0000



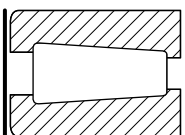
TTC, TTSP

Bore		Deviation	
Range		Precision 4	
Over	Incl.	Over	Incl.
mm in.	mm in.	mm in.	mm in.
0.000 0.0000	25.400 1.0000	+0.076 +0.0030	-0.076 -0.0030
25.400 1.0000	76.200 3.0000	+0.102 +0.0040	-0.102 -0.0040
76.200 3.0000	–	+0.127 +0.0050	-0.127 -0.0050

TABLE 20. THRUST TAPERED ROLLER BEARING TOLERANCES – OUTSIDE DIAMETER (Inch)

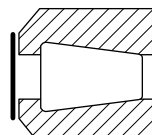
TTHD, TTHDFL, TTVS

TTC, TTSP – CLASS 4



TTHD, TTHDFL, TTVS

Outside Diameter		Bearing Class			
Range		Precision 2		Precision 3	
Over	Incl.	Over	Incl.	Max.	Min.
mm in.	mm in.	mm in.	mm in.	mm in.	mm in.
0.000 0.0000	304.800 12.0000	+0.025 +0.0010	0.000 0.0000	+0.013 +0.0005	0.000 0.0000
304.800 12.0000	609.600 24.0000	+0.051 0.0020	0.000 0.0000	+0.025 +0.0010	0.000 0.0000
609.600 24.0000	914.400 36.0000	+0.076 +0.0030	0.000 0.0000	+0.038 +0.0015	0.000 0.0000



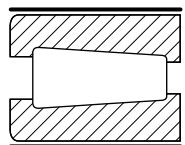
TTC, TTSP

Outside Diameter		Deviation	
Range		Precision 4	
Over	Incl.	Over	Incl.
mm in.	mm in.	mm in.	mm in.
0.000 0.0000	127.000 5.0000	+0.254 +0.0100	0.000 0.0000
127.000 5.0000	203.200 8.0000	+0.381 +0.0150	0.000 0.0000
203.200 8.0000	–	+0.508 +0.200	0.000 0.0000

TABLE 21. THRUST TAPERED ROLLER BEARING TOLERANCES – WIDTH (Inch)

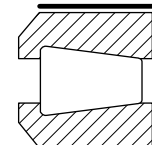
TTHD, TTHDFL, TTVS

TTC, TTSP – CLASS 4



TTHDFL

Width		Bearing Class			
Range		Precision 2		Precision 3	
Over	Incl.	Over	Incl.	Max.	Min.
mm in.	mm in.	mm in.	mm in.	mm in.	mm in.
All Sizes		+0.381 +0.0150	-0.381 -0.0150	+0.203 +0.0080	-0.203 -0.0080



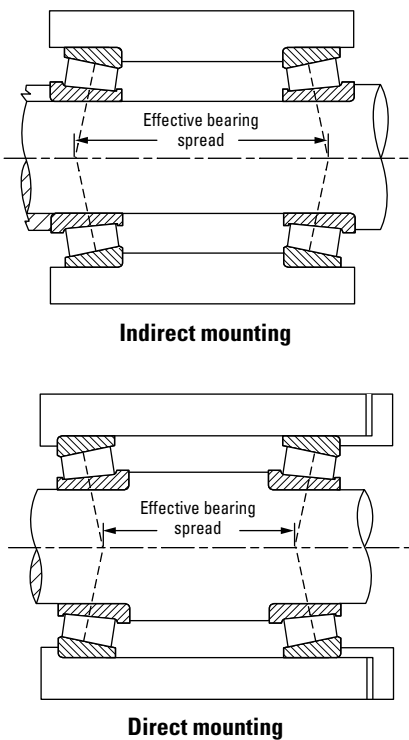
TTC, TTSP

Width		Deviation	
Range		Precision 4	
Over	Incl.	Over	Incl.
mm in.	mm in.	mm in.	mm in.
0.000 0.0000	76.200 3.0000	+0.254 +0.0100	-0.254 -0.0100
76.200 3.0000	127.000 5.0000	+0.381 +0.0150	-0.381 -0.0150
127.000 5.0000	–	+0.508 +0.200	-0.508 -0.0200

## TAPERED ROLLER BEARING MOUNTING, FITTING AND SETTING

### MOUNTING

Tapered roller bearings are designed to take both radial and thrust loading. Under radial loads, a force is generated in the axial direction that must be counteracted. As a result, tapered roller bearings are normally adjusted against a second bearing. They can be mounted in either a direct or indirect mounting arrangement shown in fig. 9. For applications where a direct mounting arrangement is used and the outer ring is used to adjust the bearing setting, the outer ring is usually set in position by an outer-ring follower or mounted in an outer-ring carrier. See fig. 10.



### FITTING PRACTICE

General industrial application fitting practice standards for inner rings and outer rings are shown in the tables starting on page 32. These tables apply to solid or heavy-sectioned steel shafts, heavy-sectioned ferrous housings and normal operating conditions. To use the tables, it is necessary to determine if the member is rotating or stationary, the magnitude, direction and type of loading, and the shaft finish.

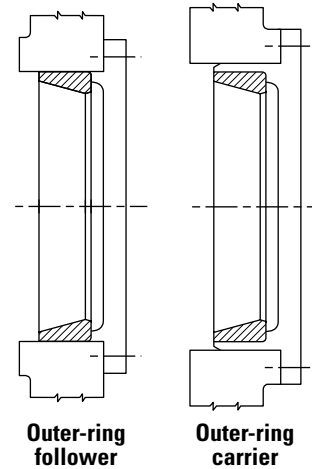


Fig. 10. Bearing setting devices - direct mounting.

Fig. 9. Comparison of mounting stability between indirect and direct mountings.

For indirect mountings, bearing setting is typically achieved by clamping against one of the inner rings. Various designs, including locknuts, stakenuts and end plates as shown in fig. 11 can be used. For applications requiring precision-class bearings, a special precision nut can be used.

Backing shoulder diameters are listed for tapered roller bearings in the product data sections in this catalog.

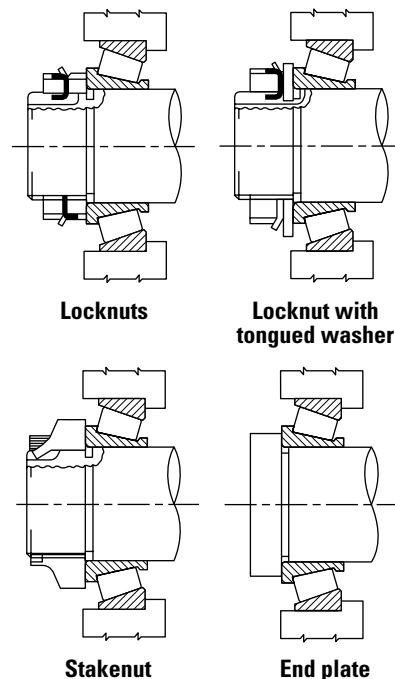


Fig. 11. Bearing setting devices – indirect mounting.

Certain table fits may not be adequate for light shaft and housing sections, shafts other than steel, nonferrous housings, critical operation conditions such as high speed, unusual thermal or loading conditions or a combination thereof. Also, assembly procedures and the means and ease of obtaining the bearing setting may require special fits. In these cases, experience should be used as a guideline or your Timken engineer should be consulted for review and suggestions.

Rotating inner rings generally should be applied with an interference fit. In special cases, loose fits may be considered if it has been determined by test or experience they will perform satisfactorily. The term "rotating inner ring" describes a condition in which the inner ring rotates relative to the load. This may occur with a rotating inner ring under a stationary load or a stationary inner ring with a rotating load. Loose fits will permit the inner rings to creep and wear the shaft and the backing shoulder. This may result in excessive bearing looseness and possible bearing and shaft damage.

Stationary inner ring fitting practice depends on the application. Under conditions of high speed, heavy loads or shock, interference fits using heavy-duty fitting practices should be used. With inner rings mounted on unground shafts subjected to moderate loads (no shock) and moderate speeds, a metal-to-metal or near zero average fit is used. In sheave and wheel applications using unground shafts, or in cases using ground shafts with moderate loads (no shock), a minimum fit near zero to a maximum looseness that varies with the inner ring bore size is suggested. In stationary inner ring applications requiring hardened and ground spindles, a slightly looser fit may be satisfactory. Special fits also may be necessary on installations such as multiple sheave crane blocks.

Rotating outer ring applications where the outer ring rotates

relative to the load should always use an interference fit.

Stationary, non-adjustable and fixed single-row outer ring applications should be applied with a tight fit wherever practical. Generally, adjustable fits may be used where the bearing setup is obtained by sliding the outer ring axially in the housing bore. However, in certain heavy-duty, high-load applications, tight fits are necessary to prevent pounding and plastic deformation of the housing. Tightly fitted outer rings mounted in carriers can be used. Tight fits should always be used when the load rotates relative to the outer ring.

To permit through-boring when the outside diameters of single-row bearings mounted at each end of a shaft are equal, and one is adjustable and the other fixed, it is suggested that the same adjustable fit be used at both ends. However, tight fits should be used if outer rings are backed against snap rings to prevent excessive dishing of snap rings, groove wear and possible loss of ring retention. Only outer rings with a maximum housing fillet radius requirement of 1.3 mm (0.05 in.) or less should be considered for a snap ring backing.

Double-row stationary double outer rings are generally mounted with loose fits to permit assembly and disassembly. The loose fit also permits float when a floating bearing is mounted in conjunction with an axially fixed bearing on the other end of the shaft.

Fitting practice tables 22-32 on pages 32-46, have been prepared for both metric and inch dimensions.

For the inch system bearings, classes 4 and 2 (standard) have been included.

The metric system bearings that have been included are: classes K and N (metric system standard bearings).

### Fit effect<sup>(1)</sup>

#### Solid shaft/heavy section housing

Setting Reduction/Width Increase for Single Inner Ring

$$= 0.5 \left( \frac{K}{0.39} \right) \left( \frac{d}{d_o} \right) \delta_S$$

Setting Reduction/Width Increase for Single Outer Ring

$$= 0.5 \left( \frac{K}{0.39} \right) \left( \frac{D_o}{D} \right) \delta_H$$

#### Hollow shaft/thin-wall section

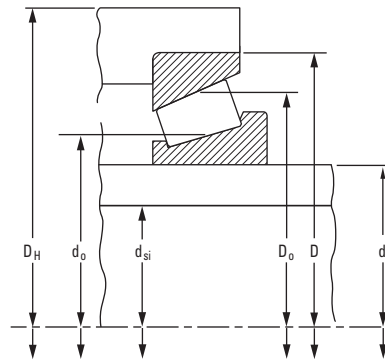
Shaft Reduction/Width Increase for Single Inner Ring

$$= 0.5 \left( \frac{K}{0.39} \right) \left( \frac{d}{d_o} \right) \left[ \frac{1 - \left( \frac{d_{si}}{d} \right)^2}{1 - \left( \frac{d_{si}}{d_o} \right)^2} \right] \delta_S$$

Shaft Reduction/Width Increase for Single Outer Ring

$$= 0.5 \left( \frac{K}{0.39} \right) \left( \frac{D_o}{D} \right) \left[ \frac{1 - \left( \frac{D}{D_H} \right)^2}{1 - \left( \frac{D_o}{D_H} \right)^2} \right] \delta_H$$

<sup>(1)</sup>These equations apply only to ferrous shaft and housing.



**Fig. 15. Dimensional parameters affecting fit and temperature effects on setting.**

## SETTING

Setting is defined as the axial clearance between roller and raceway. Establishing the setting at the time of assembly is an inherent advantage of tapered roller bearings. They can be set to provide optimum performance in almost any application. Fig. 13 gives an example of the relationship between fatigue life and bearing setting. Unlike some types of anti-friction bearings, tapered roller bearings do not rely strictly on housing or shaft fits to obtain a certain bearing setting. One ring can be moved axially relative to the other to obtain the desired bearing setting.

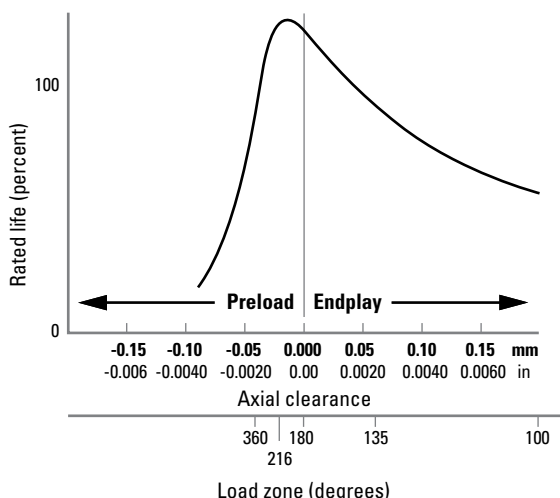


Fig. 13. Typical life vs. setting curve.

At assembly, the conditions of bearing setting are defined as:

- **Endplay (EP)** – An axial clearance between rollers and raceways producing a measurable axial shaft movement when a small axial force is applied – first in one direction then in the other, while oscillating or rotating the shaft. See fig. 14.
- **Preload (PL)** – An axial interference between rollers and raceways such that there is no measurable axial shaft movement when a small axial force is applied – in both directions – while oscillating or rotating the shaft.
- **Line-to-line** – A zero setting condition: the transitional point between endplay and preload.

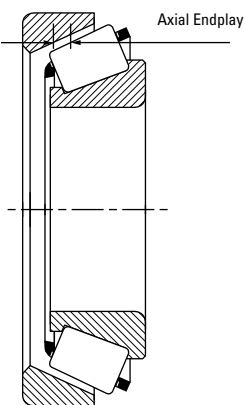


Fig. 14. Internal clearance – endplay.

Bearing setting obtained during initial assembly and adjustment is the cold or ambient bearing setting, and is established before the equipment is subjected to service.

Bearing setting during operation is known as the operating bearing setting, and is a result of changes in the ambient bearing setting due to thermal expansion and deflections encountered during service.

The ambient bearing setting necessary to produce the optimum operating bearing setting varies with the application. Application experience or testing generally determines optimum settings. Frequently, however, the exact relationship of ambient to operating bearing setting is unknown and an educated estimate has to be made. To determine a suggested ambient bearing setting for a specific application, contact your Timken engineer.

Generally, the ideal operating bearing setting is near zero to maximize bearing life (fig. 13). Most bearings are set with endplay at assembly to reach the desired near-zero setting at operating temperature.

There is an ideal bearing setting value for every application. To achieve this condition, the bearing setting must take into account deflection under load (radial + axial) as well as thermal expansions and material used.

### 1. Standard mounting

$$\text{Operating setting} = \text{mounted setting} \pm \text{temperature effect} + \text{deflection}$$

### 2. Pre-set assemblies

$$\text{Mounted EP or PL} = \text{bench EP or bench PL} - \text{effect of fits}$$

$$\text{Operating setting} = \text{mounted EP or PL (MEP or MPL)} + \text{deflection} \pm \text{temperature effect}$$

The temperature and fit effects will depend upon the type of mounting, bearing geometry and size, shaft and housing sizes, and material as defined in the following sections. Dimensional parameters affecting bearing setting are noted in fig. 15.

### Fit effect<sup>(1)</sup>

#### Solid shaft/heavy section housing

Setting Reduction/Width Increase for Single Inner Ring

$$= 0.5 \left( \frac{K}{0.39} \right) \left( \frac{d}{d_o} \right) \delta_S$$

Setting Reduction/Width Increase for Single Outer Ring

$$= 0.5 \left( \frac{K}{0.39} \right) \left( \frac{D}{D_o} \right) \delta_H$$

#### Hollow shaft/thin-wall section

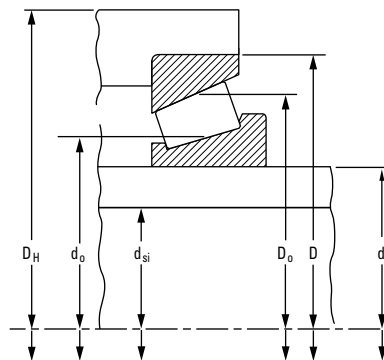
Shaft Reduction/Width Increase for Single Inner Ring

$$= 0.5 \left( \frac{K}{0.39} \right) \left( \frac{d}{d_o} \right) \left[ \frac{1 - \left( \frac{d_{si}}{d} \right)^2}{1 - \left( \frac{d_{si}}{d_o} \right)^2} \right] \delta_S$$

Shaft Reduction/Width Increase for Single Outer Ring

$$= 0.5 \left( \frac{K}{0.39} \right) \left( \frac{D_o}{D} \right) \left[ \frac{1 - \left( \frac{D}{D_H} \right)^2}{1 - \left( \frac{D_o}{D_H} \right)^2} \right] \delta_H$$

<sup>(1)</sup>These equations apply only to ferrous shaft and housing.



**Fig. 15. Dimensional parameters affecting fit and temperature effects on setting.**



## Temperature effect

### Direct mounting - setting change due to temperature

$$= \alpha_T \Delta T \left[ \left( \frac{K_1}{0.39} \right) \left( \frac{D_{o1}}{2} \right) + \left( \frac{K_2}{0.39} \right) \left( \frac{D_{o2}}{2} \right) + L \right]$$

### Indirect mounting - setting change due to temperature

$$= \alpha_T \Delta T \left[ \left( \frac{K_1}{0.39} \right) \left( \frac{D_{o1}}{2} \right) + \left( \frac{K_2}{0.39} \right) \left( \frac{D_{o2}}{2} \right) - L \right]$$

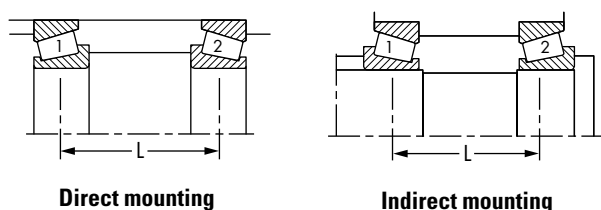


Fig. 16. Direct and indirect mounting.

## Setting methods

Upper and lower limits of bearing setting values are determined by consideration of the following factors:

- Application type.
- Duty cycle/loading.
- Operational features of adjacent mechanical drive elements.
- Changes in bearing setting due to temperature differentials and deflections.
- Size of bearing and method of obtaining bearing setting.
- Lubrication method.
- Housing and shaft material.

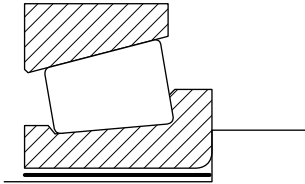
The setting value to be applied during assembly will depend on any changes that may occur during operation. In the absence of experience with bearings of similar size and operating conditions, a bearing setting range suggestion should be obtained from your Timken engineer.

These charts are guidelines for specifying shaft and housing fits related to particular operating conditions. Please contact your Timken engineer for more information.

# FITTING PRACTICE TABLES

## TAPERED ROLLER BEARINGS

### INNER RING – Industrial Equipment Classes K and N (Metric)



Deviation from nominal (maximum) bearing bore and resultant fit.

T = Tight  
L = Loose

**TABLE 22. TAPERED ROLLER BEARINGS – INNER RING**  
Industrial Equipment Classes K and N (Metric)

Inner Ring Bore		Tolerance	Rotating Inner Ring			Rotating or Stationary Inner Ring		
Range			Ground Seat			Unground Seat or Ground Seat		
Over	Incl.		Constant Loads With Moderate Shock			Heavy Loads, High Speed or Shock		
mm in.	mm in.	mm in.	Inner Ring Seat Deviation mm in.	Resultant Fit mm in.	Symbol	Inner Ring Seat Deviation mm in.	Resultant Fit mm in.	Symbol
10.000 0.3937	18.000 0.7087	-0.012 0.000 -0.0005 0.0000	+0.018 +0.007 +0.0007 +0.0003	0.030T 0.007T 0.0012T 0.0003T	m6	+0.023 +0.012 +0.0009 +0.0005	0.035T 0.012T 0.0014T 0.0005T	n6
18.000 0.7087	30.000 1.1811	-0.012 0.000 -0.0005 0.0000	+0.021 +0.008 +0.0008 +0.0003	0.033T 0.008T 0.0013T 0.0003T	m6	+0.028 +0.015 +0.0011 +0.0006	0.040T 0.015T 0.0016T 0.0006T	n6
30.000 1.1811	50.000 1.9685	-0.012 0.000 -0.0005 0.0000	+0.025 +0.009 +0.0010 +0.0004	0.037T 0.009T 0.0015T 0.0004T	m6	+0.033 +0.017 +0.0013 +0.0007	0.045T 0.017T 0.0018T 0.0007T	n6
50.000 1.9685	80.000 3.1496	-0.015 0.000 -0.0006 0.0000	+0.030 +0.011 +0.0012 +0.0004	0.045T 0.011T 0.0018T 0.0005T	m6	+0.039 +0.020 +0.0015 +0.0008	0.054T 0.020T 0.0021T 0.0008T	n6
80.000 3.1496	120.000 4.7244	-0.020 0.000 -0.0008 0.0000	+0.035 +0.013 +0.0014 +0.0005	0.055T 0.013T 0.0022T 0.0005T	m6	+0.045 +0.023 +0.0019 +0.0010	0.065T 0.023T 0.0027T 0.0010T	n6
120.000 4.7244	180.000 7.0866	-0.025 0.000 -0.0010 0.0000	+0.052 +0.027 +0.0020 +0.0011	0.077T 0.027T 0.0030T 0.0011T	n6	+0.068 +0.043 +0.0027 +0.0017	0.093T 0.043T 0.0037T 0.0017T	p6
180.000 7.0866	200.000 7.8740	-0.030 0.000 -0.0012 0.0000	+0.060 +0.031 +0.0024 +0.0012	0.090T 0.031T 0.0035T 0.0012T	n6	+0.106 +0.077 +0.0042 +0.0030	0.136T 0.077T 0.0054T 0.0030T	r6
200.000 7.8740	225.000 8.8583					+0.109 +0.080 +0.0043 +0.0031	0.139T 0.080T 0.0055T 0.0031T	
225.000 8.8583	250.000 9.8425					+0.113 +0.084 0.0044 +0.0033	0.143T 0.084T 0.0056T 0.0033T	
250.000 9.8425	280.000 11.0236	-0.035 0.000 -0.0014 0.0000	+0.066 +0.033 +0.0026 +0.0013	0.101T 0.033T 0.0040T 0.0013T	n6	+0.146 +0.094 +0.0057 +0.0037	0.181T 0.094T 0.0071T 0.0037T	r7
280.000 11.0236	315.000 12.4016					+0.150 +0.098 +0.0059 +0.0039	0.185T 0.098T 0.0073T 0.0039T	

These charts are guidelines for specifying shaft and housing fits related to particular operating conditions. Please contact your Timken engineer for more information.

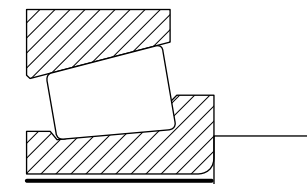
Stationary Inner Ring											
Unground Seat			Ground Seat			Unground Seat			Hardened and Ground Seat		
Moderate Loads, No Shock			Moderate Loads, No Shock			Sheaves, Wheels, Idlers			Wheel Spindles		
Inner Ring Seat Deviation	Resultant Fit	Symbol	Inner Ring Seat Deviation	Resultant Fit	Symbol	Inner Ring Seat Deviation	Resultant Fit	Symbol	Inner Ring Seat Deviation	Resultant Fit	Symbol
mm in.	mm in.		mm in.	mm in.		mm in.	mm in.		mm in.	mm in.	
0.000 -0.011 0.0000 -0.0004	0.012T 0.011L 0.0005T 0.0004L	h6	-0.006 -0.017 -0.0002 -0.0007	0.006T 0.017L 0.0002T 0.0007L	g6	-0.006 -0.017 -0.00025 -0.00065	0.006T 0.017L -0.00025T 0.00065L	g6	-0.016 -0.027 -0.0006 -0.0011	0.004L 0.027L 0.0002L 0.0011L	f6
0.000 -0.013 0.0000 -0.0005	0.012T 0.013L 0.0005T 0.0005L	h6	-0.007 -0.020 -0.0003 -0.0008	0.005T 0.020L 0.0002T 0.0008L	g6	-0.007 -0.020 -0.0003 -0.0008	0.005T 0.020L 0.0002T 0.0008L	g6	-0.020 -0.033 -0.0008 -0.0013	0.008L 0.033L 0.0003L 0.0013L	f6
0.000 -0.016 0.0000 -0.0006	0.012T 0.016L 0.0005T 0.0006L	h6	-0.009 -0.025 -0.0004 -0.0010	0.003T 0.025L 0.0001T 0.0010L	g6	-0.009 -0.025 -0.0004 -0.0010	0.003T 0.025L 0.0001T 0.0010L	g6	-0.025 -0.041 -0.0010 -0.0016	0.013L 0.041L 0.0005L 0.0016L	f6
0.000 -0.019 0.0000 -0.0007	0.015T 0.019L 0.0006T 0.0007L	h6	-0.010 -0.029 -0.0004 -0.0011	0.005T 0.029L 0.0002T 0.0011L	g6	-0.010 -0.029 -0.0004 -0.0011	0.005T 0.029L 0.0002T 0.0011L	g6	-0.030 -0.049 -0.0012 -0.0019	0.015L 0.049L 0.0006L 0.0019L	f6
0.000 -0.022 0.0000 -0.0009	0.020T 0.022L 0.0008T 0.0009L	h6	-0.012 -0.034 -0.0005 -0.0014	0.008T 0.034L 0.0003T 0.0014L	g6	-0.012 -0.034 -0.0005 -0.0014	0.008T 0.034L 0.0003T 0.0014L	g6	-0.036 -0.058 -0.0014 -0.0023	0.016L 0.058L 0.0006L 0.0023L	f6
0.000 -0.025 0.0000 -0.0010	0.025T 0.025L 0.0010T 0.0010L	h6	-0.014 -0.039 -0.0006 -0.0016	0.011T 0.039L 0.0004T 0.0016L	g6	-0.014 -0.039 -0.0006 -0.0016	0.011T 0.039L 0.0004T 0.0016L	g6	-0.043 -0.068 -0.0016 -0.0026	0.018L 0.068L 0.0006L 0.0026L	f6
0.000 -0.029 0.0000 -0.0011	0.030T 0.029L 0.0012T 0.0011L	h6	-0.015 -0.044 -0.0006 -0.0017	0.015T 0.044L 0.0006T 0.0017L	g6	-0.015 -0.044 -0.0006 -0.0017	0.015T 0.044L 0.0006T 0.0017L	g6	-0.050 -0.079 -0.0020 -0.0031	0.020L 0.079L 0.0008L 0.0031L	f6
0.000 -0.032 0.0000 -0.0012	0.035T 0.032L 0.0014T 0.0012L	h6	-0.017 -0.049 -0.0007 -0.0019	0.018T 0.049L 0.0007T 0.0019L	g6	-0.017 -0.049 -0.0007 -0.0019	0.018T 0.049L 0.0007T 0.0019L	g6	-0.056 -0.068 -0.0022 -0.0027	0.021L 0.088L 0.0008L 0.0035L	f6

Continued on next page.

## FITTING PRACTICE TABLES

These charts are guidelines for specifying shaft and housing fits related to particular operating conditions. Please contact your Timken engineer for more information.

### INNER RING – Industrial Equipment Classes K and N (Metric)



Deviation from nominal (maximum)  
bearing bore and resultant fit.

T= Tight  
L = Loose

Table 22 continued.

Inner Ring Bore		Tolerance	Rotating Inner Ring			Rotating or Stationary Inner Ring		
Range			Ground Seat			Unground Seat or Ground Seat		
Over	Incl.		Constant Loads With Moderate Shock			Heavy Loads, High Speed or Shock		
mm in.	mm in.	mm in.	Inner Ring Seat Deviation	Resultant Fit	Symbol	Inner Ring Seat Deviation	Resultant Fit	Symbol
315.000 12.4016	355.000 13.9764	-0.040 0.000 -0.0016 0.0000	+0.073 +0.037 +0.0029 +0.0015	0.113T 0.037T 0.0044T 0.0015T	n6	+0.165 +0.108 +0.0065 +0.0043	0.205T 0.108T 0.0081T 0.0043T	r7
355.000 13.9764	400.000 15.7480	-0.045 0.000 -0.0018 0.0000	+0.080 +0.040 +0.0031 +0.0016	0.0125T 0.040T 0.0049T 0.0016T	n6	+0.189 +0.126 +0.0074 +0.0092	0.234T 0.126T 0.0092T 0.0050T	r7
400.000 15.7580	450.000 17.7165	-0.050 0.000 -0.0020 0.0000	+0.100 +0.050 +0.0039 +0.0020	0.150T 0.050T 0.0059T 0.0020T	-	+0.200 +0.125 +0.0079 +0.0049	0.250T 0.125T 0.0098T 0.0049T	-
630.000 24.8032	800.000 31.4961	-0.080 0.000 -0.0031 0.0000	+0.125 +0.050 +0.0049 +0.0020	0.205T 0.050T 0.0081T 0.0020T	-	+0.225 +0.150 +0.0089 +0.0059	0.305T 0.105T 0.0102T 0.0041T	-
800.000 31.4961	1000.000 39.3701	-0.100 0.000 -0.0039 0.0000	+0.150 +0.050 +0.0059 +0.0020	0.250T 0.050T 0.0098T 0.0020T	-	+0.275 +0.175 +0.0108 +0.0069	0.375T 0.175T 0.0148T 0.0069T	-

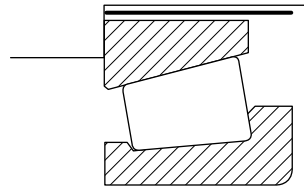
These charts are guidelines for specifying shaft and housing fits related to particular operating conditions. Please contact your Timken engineer for more information.

Stationary Inner Ring											
Unground Seat			Ground Seat			Unground Seat			Hardened and Ground Seat		
Moderate Loads, No Shock			Moderate Loads, No Shock			Sheaves, Wheels, Idlers			Wheel Spindles		
Inner Ring Seat Deviation	Resultant Fit	Symbol	Inner Ring Seat Deviation	Resultant Fit	Symbol	Inner Ring Seat Deviation	Resultant Fit	Symbol	Inner Ring Seat Deviation	Resultant Fit	Symbol
mm in.	mm in.		mm in.	mm in.		mm in.	mm in.		mm in.	mm in.	
0.000 -0.036 0.0000 -0.0014	0.040T 0.036L 0.0016T 0.0014L	h6	-0.018 -0.075 -0.0007 -0.0030	0.022T 0.075L 0.0009T 0.0030L	g7	-0.018 -0.075 -0.0007 -0.0029	0.022T 0.075L 0.0009T 0.0029L	g7	-	-	-
0.000 -0.040 0.0000 -0.0020	0.045T 0.040L 0.0018T 0.0016L	h6	-0.020 -0.083 -0.0008 -0.0033	0.025T 0.083L 0.0008T 0.0033L	g7	-0.020 -0.083 -0.0008 -0.0033	0.025T 0.083L 0.0008T 0.0033L	g7	-	-	-
0.000 -0.050 0.0000 -0.0020	0.050T 0.050L 0.0020T 0.0020L	-	-0.050 -0.100 -0.0020 -0.0039	0.000 0.100L 0.0000 0.0039L	-	-0.050 -0.100 -0.0020 -0.0039	0.000 0.100L 0.0000 0.0039L	-	-	-	-
0.000 -0.075 0.0000 -0.0030	0.080T 0.075L 0.0031T 0.0030L	-	-0.080 -0.150 -0.0031 -0.0059	0.000 0.150L 0.0000 0.0059L	-	-0.080 -0.150 -0.0031 -0.0059	0.000 0.150L 0.0000 0.0059L	-	-	-	-
0.000 -0.100 0.0000 -0.0039	0.100T 0.100L 0.0039T 0.0039L	-	-0.100 -0.200 -0.0039 -0.0079	0.000 0.200L 0.0000 0.0079L	-	-0.100 -0.200 -0.0039 -0.0079	0.000 0.200L 0.0000 0.0079L	-	-	-	-

## FITTING PRACTICE TABLES

These charts are guidelines for specifying shaft and housing fits related to particular operating conditions. Please contact your Timken engineer for more information.

### OUTER RING – Industrial Equipment Classes K and N (Metric)



Deviation from nominal (maximum)  
bearing O.D. and resultant fit.

T = Tight  
L = Loose

**TABLE 23. TAPERED ROLLER BEARINGS – OUTER RING – Industrial Equipment Classes K and N (Metric)**

Outer Ring O.D.		Tolerance	Stationary Cup									Rotating Cup		
Range			Floating or Clamped			Adjustable			Nonadjustable or in Carriers			Nonadjustable or in Carriers or Sheaves - Clamped		
Over	Incl.		Outer Ring Seat Deviation	Resultant Fit	Symbol	Outer Ring Seat Deviation	Resultant Fit	Symbol	Outer Ring Seat Deviation	Resultant Fit	Symbol	Outer Ring Seat Deviation	Resultant Fit	Symbol
mm in.	mm in.	mm in.	mm in.	mm in.	mm in.	mm in.	mm in.	mm in.	mm in.	mm in.	mm in.	mm in.	mm in.	
18.000 0.7087	30.000 1.1811	0.000 -0.012 0.0000 -0.0005	+0.007 +0.028 0.0003 +0.0011	0.007L 0.040L 0.0003L 0.0016L	G7	-0.009 +0.012 -0.0004 +0.0005	0.009T 0.024L 0.0004T 0.0009L	J7	-0.035 -0.014 -0.0014 -0.0005	0.035T 0.002T 0.0014T 0.0001T	P7	-0.041 -0.020 -0.0016 -0.0009	0.041T 0.008T 0.0016T 0.0003T	R7
30.000 1.1811	50.000 1.9685	0.000 -0.014 0.0000 -0.0006	+0.009 +0.034 +0.0004 +0.0013	0.009L 0.048L 0.0004L 0.0019L	G7	-0.011 +0.014 -0.0004 +0.0006	0.011T 0.028L 0.0004T 0.0011L	J7	-0.042 -0.017 -0.0017 -0.0007	0.042T 0.003T 0.0017T 0.0001T	P7	-0.050 -0.025 -0.0020 -0.0010	0.050T 0.011T 0.0020T 0.0004T	R7
50.000 1.9685	65.000 2.5591	0.000 -0.016 0.0000 -0.0006	+0.010 +0.040 +0.0004 +0.0016	0.010L 0.056L 0.0004L 0.0022L	G7	-0.012 +0.018 -0.0005 +0.0007	0.012T 0.034L 0.0005T 0.0013L	J7	-0.051 -0.021 -0.0020 -0.0008	0.051T 0.005T 0.0020T 0.0002T	P7	-0.060 -0.030 -0.0024 -0.0012	0.060T 0.014T 0.0024T 0.0006T	R7
65.000 2.5591	80.000 3.1496											-0.062 -0.032 -0.0021 -0.0013	0.062T 0.016T 0.0024T 0.0006T	
80.000 3.1496	100.000 3.9370	0.000 -0.018 0.0000 -0.0007	+0.012 +0.047 +0.0005 +0.0019	0.012L 0.065L 0.0005L 0.0026L	G7	-0.013 +0.022 -0.0005 +0.0009	0.013T 0.040L 0.0005T 0.0016L	J7	-0.059 -0.024 -0.0023 -0.0009	0.059T 0.006T 0.0023T 0.0002T	P7	-0.073 -0.038 -0.0029 -0.0015	0.073T 0.020T 0.0029T 0.0008T	R7
100.000 3.9370	120.000 4.7244											-0.076 -0.041 -0.0030 -0.0016	0.076T 0.023T 0.0030T 0.0009T	
120.000 4.7244	140.000 5.5188	0.000 -0.020 0.0000 -0.0008	+0.014 +0.054 +0.0006 +0.0021	0.014L 0.074L 0.0006L 0.0029L	G7	-0.014 +0.026 -0.0006 +0.0010	0.014T 0.046L 0.0006T 0.0018L	J7	-0.068 -0.028 -0.0027 -0.0011	0.068T 0.074T 0.0027T 0.0003T	P7	-0.088 -0.048 -0.0035 -0.0019	0.088T 0.028T 0.0035T 0.0011T	R7
140.000 5.5188	150.000 5.9055											-0.090 -0.050 -0.0035 -0.0020	0.090T 0.030T 0.0035T 0.0012T	
150.000 5.9055	160.000 6.2992	0.000 -0.025 0.0000 -0.0010	+0.014 +0.054 +0.0006 +0.0021	0.014L 0.079L 0.0006L 0.0031L	G7	-0.014 +0.026 -0.0006 +0.0010	0.014L 0.051L 0.0006T 0.0020L	J7	-0.068 -0.028 -0.0027 -0.0011	0.068T 0.003T 0.0027T 0.0001T	P7	-0.090 -0.050 -0.0035 -0.0020	0.090T 0.025T 0.0035T 0.0010T	R7
160.000 6.2992	180.000 7.0866											-0.093 -0.053 -0.0037 -0.0021	0.093T 0.028T 0.0037T 0.0011T	

Continued on next page.

These charts are guidelines for specifying shaft and housing fits related to particular operating conditions. Please contact your Timken engineer for more information.

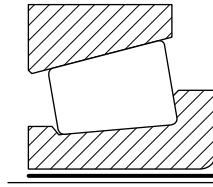
Table 23 continued.

Outer Ring O.D.		Tolerance	Stationary Cup									Rotating Cup		
Range			Floating or Clamped			Adjustable			Nonadjustable or in Carriers			Nonadjustable or in Carriers or Sheaves - Clamped		
Over	Incl.		Outer Ring Seat Deviation	Resultant Fit	Symbol	Outer Ring Seat Deviation	Resultant Fit	Symbol	Outer Ring Seat Deviation	Resultant Fit	Symbol	Outer Ring Seat Deviation	Resultant Fit	Symbol
mm in.	mm in.	mm in.	mm in.	mm in.	mm in.	mm in.	mm in.	mm in.	mm in.	mm in.	mm in.	mm in.	mm in.	
180.000 7.0866	200.000 7.8740	0.000 -0.030 0.0000 -0.0012	+0.015 +0.061 +0.0006 +0.0024	0.015L 0.091L 0.0006L 0.0036L	G7	-0.016 +0.030 -0.00076 +0.0012	0.016T 0.060L 0.0006T 0.0024L	J7	-0.079 -0.033 -0.0031 -0.0014	0.079T 0.003T 0.0031T 0.0001T	P7	-0.106 -0.060 -0.0042 -0.0024	0.106T 0.030T 0.0042T 0.0012T	R7
200.000 7.8740	225.000 8.8583											-0.109 -0.063 -0.0043 -0.0025	0.109T 0.033T 0.0043T 0.0013T	
225.000 8.8583	250.000 9.8425											-0.113 -0.067 -0.0044 -0.0026	0.113T 0.037T 0.0044T 0.0015T	
250.000 9.8425	280.000 11.0236	0.000 -0.035 0.0000 -0.0014	+0.017 +0.069 +0.0007 +0.0027	0.017L 0.104L 0.0007L 0.0041L	G7	-0.016 +0.036 -0.0006 +0.0013	0.016T 0.071L 0.0006T 0.0028L	J7	-0.088 -0.036 -0.0035 -0.0014	0.088T 0.001T 0.0035T 0.0000	P7	-0.126 -0.074 -0.0050 -0.0029	0.126T 0.039T 0.0050T 0.0015T	R7
280.000 11.0236	315.000 12.4016											-0.130 -0.078 -0.0051 -0.0031	0.130T 0.043T 0.0051T 0.0017T	
315.000 12.4016	355.000 13.9764	0.000 -0.040 0.0000 -0.0016	+0.062 +0.098 +0.0024 +0.0039	0.062L 0.138L 0.0024L 0.0054L	F6	-0.018 +0.039 -0.0007 +0.0015	0.018T 0.079L 0.0007T 0.0031L	J7	-0.098 -0.041 -0.0039 -0.0016	0.098T 0.001T 0.0039T 0.0001T	P7	-0.144 -0.087 -0.0057 -0.0034	0.144T 0.047T 0.0057T 0.0019T	R7
355.000 13.9764	400.000 15.7480											-0.150 -0.093 -0.0059 -0.0037	0.150T 0.053T 0.0059T 0.0021T	
400.000 15.7480	450.000 17.7165	0.000 -0.045 0.0000 -0.0018	+0.068 +0.095 +0.0027 +0.0037	0.068L 0.140L 0.0027L 0.0055L	F5	-0.020 +0.043 -0.0008 +0.0017	0.020T 0.088L 0.0008T 0.0035L	J7	-0.108 -0.045 -0.0043 -0.0018	0.108T 0.000 0.0043T 0.0000	P7	-0.166 -0.103 -0.0065 -0.0041	0.166T 0.058T 0.0065T 0.0023T	R7
450.000 17.7165	500.000 19.6850											-0.172 -0.109 -0.0068 -0.0043	0.172T 0.064T 0.0068T 0.0025T	
500.000 19.6850	630.000 24.8032	0.000 -0.050 0.0000 -0.0020	+0.065 +0.115 +0.0026 +0.0045	0.065L 0.165L 0.0026L 0.0065L	-	-0.022 +0.046 -0.0009 +0.0018	0.022T 0.096L 0.0009T 0.0038L	-	-0.118 -0.050 -0.0046 -0.0020	0.118T 0.000 0.0046T 0.0000	-	-0.190 -0.120 -0.0075 -0.0047	0.190T 0.070T 0.0075T 0.0028T	R7
630.000 24.8032	800.000 31.4961	0.000 -0.080 0.0000 -0.0031	+0.075 +0.150 +0.0030 +0.0059	0.075L 0.225L 0.0030L 0.0089L	-	-0.025 +0.050 -0.0098 +0.0020	0.025T 0.130L 0.0098T 0.0051L	-	-0.150 -0.075 -0.0059 -0.0030	0.150T 0.000 0.0059T 0.0000	-	-	-	R7
800.000 31.4961	1000.000 39.3701	0.000 -0.100 0.0000 -0.0039	+0.075 +0.175 +0.0030 +0.0069	0.075L 0.275L 0.0030L 0.0108L	-	-0.025 +0.075 -0.0098 +0.0030	0.025T 0.175L 0.0098T 0.0069L	-	-0.200 -0.100 -0.0079 -0.0039	0.200T 0.000 0.0079T 0.0000	-	-	-	R7

## FITTING PRACTICE TABLES

These charts are guidelines for specifying shaft and housing fits related to particular operating conditions. Please contact your Timken engineer for more information.

### INNER RING – Industrial Equipment Classes 4 and 2 (Inch)



Deviation from nominal (minimum) bearing bore and resultant fit.

T = Tight  
L = Loose

**TABLE 24. TAPERED ROLLER BEARINGS – INNER RING – Industrial Equipment Classes 4 and 2 (Inch)**

Inner Ring Bore		Tolerance <sup>(1)</sup>	Rotating Inner Ring		Rotating or Stationary Inner Ring		Stationary Inner Ring							
Range			Ground Seat		Unground or Ground Seat		Unground Seat		Ground Seat		Unground Seat		Hardened and Ground Seat	
Over	Incl.		Constant Loads With Moderate Shock		Heavy Loads, or High Speed Or Shock		Moderate Loads, No Shock		Moderate Loads, No Shock		Sheaves, Wheels, Idlers		Wheel Spindles	
			Inner Ring Seat Deviation	Resultant Fit	Inner Ring Seat Deviation	Resultant Fit	Inner Ring Seat Deviation	Resultant Fit	Inner Ring Seat Deviation	Resultant Fit	Inner Ring Seat Deviation	Resultant Fit	Inner Ring Seat Deviation	Resultant Fit
mm in.	mm in.	mm in.	mm in.	mm in.	mm in.	mm in.	mm in.	mm in.	mm in.	mm in.	mm in.	mm in.	mm in.	mm in.
0.000 0.0000	76.200 3.0000	0.000 +0.013 0.0000 +0.0005	+0.038 <sup>(2)</sup> +0.026 0.0015 +0.0010	0.038T 0.012T 0.0015T 0.0005T	+0.064 +0.038 +0.0025 +0.0015	0.064T 0.025T 0.0025T 0.0010T	+0.013 0.000 +0.0005T 0.0000	0.013T 0.013L 0.0005T 0.0005L	0.000 -0.013 0.0000 -0.0005	0.000 0.026L 0.0000 0.0010L	0.000 -0.013 0.0000 -0.0005	0.000 0.026L 0.0000 0.0010L	-0.005 -0.018 -0.0002 -0.0007	0.005L 0.031L 0.0002L 0.0012L
76.200 3.0000	304.800 12.0000	0.000 +0.025 0.0000 +0.0010	+0.064 +0.038 +0.0025 +0.0015	0.064T 0.013T 0.0025T 0.0005T	Use Average Tight Inner Ring Fit of 0.0005 mm/mm (0.0005in./in.) of Inner Ring Bore <sup>(3)</sup>		+0.025 0.000 +0.0010 0.0000	0.025T 0.025L 0.0010T 0.0010L	0.000 -0.025 0.0000 -0.0010	0.000 0.051L 0.0000 0.0020L	0.000 0.000 0.0000 -0.0010	0.000 0.051L 0.0000 0.0020L	-0.005 -0.031 -0.0002 -0.0012	0.005L 0.056L 0.0002L 0.0022L
304.800 12.0000	609.600 24.0000	0.000 +0.051 0.0000 +0.0020	+0.127 +0.076 +0.0050 +0.0030	0.127T 0.025T 0.0050T 0.0010T			+0.051 0.000 +0.0020 0.0000	0.051T 0.051L 0.0020T 0.0020L	0.000 -0.051 0.0000 -0.0020	0.000 0.102L 0.0000 0.0040L	0.000 -0.051 0.0000 -0.0020	0.000 0.102L 0.0000 0.0040L	-	-
609.600 24.0000	914.400 36.0000	0.000 +0.076 0.0000 +0.0030	+0.191 +0.114 +0.0075 +0.0015T				+0.076 0.000 +0.0030 0.0000	0.076T 0.076L 0.0030T 0.0030L	0.000 -0.076 0.0000 -0.0030	0.000 0.152L 0.0000 0.0060L	0.000 -0.076 0.0000 -0.0030	0.000 0.152L 0.0000 0.0060L	-	-

<sup>(1)</sup>Does not apply to TNASW and TNASWE type bearings.

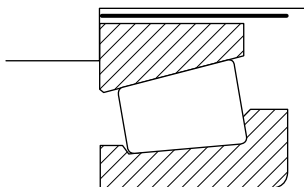
<sup>(2)</sup>Example: If the minimum inner ring bore is 76.200 mm (3.0000 in.) the suggested shaft size = 76.238 mm (3.0015 in.) to 76.225 mm (3.0010 in.) for an inner ring fit of 0.038 mm (0.0015 in.) tight to 0.012 mm (0.0005 in.) tight.

<sup>(3)</sup>For inner ring bores between 76.200 mm (3.0000 in.) and 101.600 mm (4.0000 in.) use a minimum fit of 0.025 mm (0.0001 in.) tight.



These charts are guidelines for specifying shaft and housing fits related to particular operating conditions. Please contact your Timken engineer for more information.

**OUTER RING –  
Industrial Equipment  
Classes 4 and 2 (Inch)**



Deviation from nominal (minimum)  
bearing O.D. and resultant fit.

T= Tight  
L = Loose

**TABLE 25. TAPERED ROLLER BEARINGS – OUTER RING – Industrial Equipment Classes 4 and 2 (Inch)**

Outer Ring O.D.		Tolerance	Stationary Outer Ring				Stationary Or Rotating Outer Ring		Rotating Outer Ring	
Range			Floating or Clamped		Adjustable		Non-adjustable or In Carriers, Sheaves - Clamped		Sheaves - Unclamped <sup>(1)</sup>	
Over	Incl.		Outer Ring Seat Deviation	Resultant Fit	Outer Ring Seat Deviation	Resultant Fit	Outer Ring Seat Deviation	Resultant Fit	Outer Ring Seat Deviation	Resultant Fit
mm in.	mm in.	mm in.	mm in.	mm in.	mm in.	mm in.	mm in.	mm in.	mm in.	
0.000 0.0000	76.200 3.0000	+0.025	+0.050	0.026L	0.000	0.025T	-0.039	0.064T	-0.077	0.102T
		0.000	+0.076	0.076L	+0.025	0.025L	-0.013	0.013T	-0.051	0.051T
		+0.0010	+0.0020	0.0010L	0.0000	0.0010T	-0.0015	0.0025T	-0.0030	0.0040T
		0.0000	+0.0030	0.0030L	+0.0010	0.0010L	-0.0005	0.0005T	-0.0020	0.0020T
76.200 3.0000	127.000 5.0000	+0.025	+0.050	0.026L	0.000	0.025T	-0.051	0.076T	-0.077	0.102T
		0.000	+0.076	0.076L	+0.025	0.025L	-0.025	0.025T	-0.051	0.051T
		+0.0010	+0.0020	0.0010L	0.0000	0.0010T	-0.0020	0.0030T	-0.0030	0.0040T
		0.0000	+0.0030	0.0030L	+0.0010	0.0010L	-0.0010	0.0010T	-0.0020	0.0020T
127.000 5.0000	304.800 12.0000	+0.025	+0.050	0.026L	0.000	0.025T	-0.051	0.076T	-0.077	0.102T
		0.000	+0.076	0.076L	+0.051	0.051L	-0.025	0.025T	-0.051	0.051T
		+0.0010	+0.0020	0.0010L	0.0000	0.0010T	-0.0020	0.0030T	-0.0030	0.0040T
		0.0000	+0.0030	0.0030L	+0.0020	0.0020L	-0.0010	0.0010T	-0.0020	0.0020T
304.800 12.0000	609.600 24.0000	+0.051	+0.102	0.051L	+0.026	0.025T	-0.076	0.127T	-0.102	0.153T
		0.000	+0.152	0.152L	+0.076	0.076L	-0.025	0.025T	-0.051	0.051T
		+0.0020	+0.0040	0.0020L	+0.0010	0.0010T	-0.0030	0.0050T	-0.0040	0.0060T
		0.0000	+0.0060	0.0060L	+0.0030	0.0030L	-0.0010	0.0010T	-0.0020	0.0020T
609.600 24.0000	914.400 36.0000	+0.076	+0.152	0.076L	+0.051	0.025T	-0.102	0.178T	-	-
		0.000	+0.229	0.229L	+0.127	0.0127L	-0.025	0.025T	-	-
		+0.0030	+0.0060	0.0030L	+0.0020	0.0010T	-0.0040	0.0070T	-	-
		0.0000	+0.0090	0.0090L	+0.0050	0.0050L	-0.0010	0.0010T	-	-

<sup>(1)</sup>Unclamped outer ring design is applicable only to sheaves with negligible fleet angle.

## FITTING PRACTICE TABLES

These charts are guidelines for specifying shaft and housing fits related to particular operating conditions. Please contact your Timken engineer for more information.

### INNER RING – Automotive Equipment Class 4 and 2 (Inch)

Deviation from nominal (minimum)  
bearing bore and resultant fit.

T= Tight  
L = Loose

**TABLE 26. TAPERED ROLLER BEARINGS – INNER RING**  
Automotive Equipment Classes 4 and 2 (Inch)

Inner Ring Bore		Tolerance	Shaft O.D.					
			Stationary Inner Ring		Rotating Inner Ring			
			Front Wheels Rear Wheel (Full-Floating Axles) Trailer Wheels		Rear Wheels (Semi-Floating Axles)		Rear Wheels (Unit-Bearing) (Semi-Floating Axles)	
Over	Incl.		Non-adjustable					
			Shaft O.D. Deviation	Resultant Fit	Shaft O.D. Deviation	Resultant Fit	Shaft O.D. Deviation	Resultant Fit
mm in.	mm in.	mm in.	mm in.	mm in.	mm in.	mm in.	mm in.	mm in.
0.000 0.0000	76.200 3.0000	0.000	-0.005	0.005L	+0.051	0.051T	+0.056	0.056T
		+0.0013	-0.018	0.031L	+0.038	0.025T	+0.038	0.025T
		0.0000	-0.0002	0.0002L	+0.0020	0.0020T	+0.0022	0.0022T
		+0.0005	-0.0007	0.0012L	+0.0015	0.0010T	+0.0015	0.0010T
76.200 3.0000	304.800 12.0000	0.000	-0.0013	0.013L	+0.076	0.076T	-	-
		+0.0025	-0.038	0.063L	+0.051	0.026T	-	-
		0.0000	-0.0050	0.0005L	+0.0030	0.0030T	-	-
		+0.0010	-0.0015	0.0025L	+0.0020	0.0010T	-	-

### OUTER RING – Automotive Equipment Classes 4 and 2 (Inch)

**TABLE 27. TAPERED ROLLER BEARINGS – OUTER RING**  
Automotive Equipment Classes 4 and 2 (Inch)

Outer Ring O.D.		Tolerance	Housing Bore	
			Rotating Outer Ring	
			Front Wheels	Rear Wheels (Full-Floating Trailer Wheels)
Over	Incl.		Non-adjustable	
			Housing Bore Deviation	Resultant Fit
mm in.	mm in.	mm in.	mm in.	mm in.
0.000 0.0000	76.200 3.0000	+0.025	-0.051	0.076T
		0.000	-0.013	0.013T
		+0.0010	-0.0020	0.0030T
		0.0000	-0.0005	0.0005T
76.200 3.0000	127.000 5.0000	+0.025	-0.077	0.102T
		0.000	-0.025	0.025T
		+0.0010	-0.0030	0.0040T
		0.0000	-0.0010	0.0010T
127.000 5.0000	304.800 12.0000	+0.025	-0.077	0.102T
		0.000	-0.025	0.025T
		+0.0010	-0.0030	0.0040T
		0.0000	-0.0010	0.0010T

These charts are guidelines for specifying shaft and housing fits related to particular operating conditions. Please contact your Timken engineer for more information.

Shaft O.D.									
Rotating Inner Ring									
Pinion					Differential			Transaxles Transmissions Transfer Cases Cross Shafts	
Clamped		Collapsible Spacer		Non-adjustable		Non-adjustable		Non-adjustable	
Shaft O.D. Deviation	Resultant Fit	Shaft O.D. Deviation	Resultant Fit	Shaft O.D. Deviation	Resultant Fit	Shaft O.D. Deviation	Resultant Fit	Shaft O.D. Deviation	Resultant Fit
mm in.	mm in.	mm in.	mm in.	mm in.	mm in.	mm in.	mm in.	mm in.	mm in.
+0.025 +0.013 +0.0010 +0.0005	0.025T 0.000 0.0010T 0.0000	+0.030 +0.018 +0.0012 +0.0007	0.030T 0.005T 0.0012T 0.0002T	+0.051 +0.038 +0.0020 +0.0015	0.051T 0.025T 0.0020T 0.0010T	+0.102 +0.064 +0.0040 +0.0025	0.102T 0.051T 0.0040T 0.0020T	+0.038 +0.025 +0.0015 +0.0010	0.038T 0.012T 0.0015T 0.0005T
+0.038 +0.013 +0.0015 +0.0005	0.038T 0.012T 0.0015T 0.0005T	-	-	+0.076 +0.051 +0.0030 +0.0020	0.076T 0.026T 0.0030T 0.0010T	+0.102 +0.076 +0.0040 +0.0025	0.102T 0.051T 0.0040T 0.0020T	+0.064 +0.038 +0.0025 +0.0015	0.064T 0.013T 0.0025T 0.0005T

Housing Bore							
Stationary Outer Ring							
Rear Wheels	(Semi-Floating Axles)	Differential	(Split Seat)	Transmissions	Transfer Cases Cross Shafts	Pinion (Solid Seat) Transmission	Differential Transaxles Transfer Cases
Adjustable (TS) Clamped (TSU)		Adjustable		Adjustable		Non-adjustable	
Housing Bore Deviation	Resultant Fit	Housing Bore Deviation	Resultant Fit	Housing Bore Deviation	Resultant Fit	Housing Bore Deviation	Resultant Fit
mm in.	mm in.	mm in.	mm in.	mm in.	mm in.	mm in.	mm in.
+0.038 +0.076 +0.0015 +0.0030	0.013L 0.076L 0.0005L 0.0030L	+0.025 +0.051 +0.0010 +0.0020	0.000 0.051L 0.0000 0.0020L	0.000 +0.025 0.000 +0.0010	0.025T 0.025L 0.0010T 0.0010L	-0.038 -0.013 -0.0015 -0.0005	0.063T 0.013T 0.0025T 0.0005T
+0.038 +0.076 +0.0015 +0.0030	0.013L 0.076L 0.0005L 0.0030L	+0.025 +0.051 +0.0010 +0.0020	0.000 0.051L 0.0000 0.0020L	0.000 +0.025 0.0000 +0.0010	0.025T 0.025L 0.0010T 0.0010L	-0.051 -0.025 -0.0020 -0.0010	0.076T 0.025T 0.0030T 0.0010T
-	-	0.000 +0.051 0.0000 +0.0020	0.025T 0.051L 0.0010T 0.0020L	0.000 +0.051 0.0000 +0.0020	0.025T 0.051L 0.0010T 0.0020L	-0.077 -0.025 -0.0030 -0.0010	0.102T 0.025T 0.0040T 0.0010T

These charts are guidelines for specifying shaft and housing fits related to particular operating conditions. Please contact your Timken engineer for more information.

**INNER RING – Automotive Equipment  
Classes K and N (Metric)**

**TABLE 28. TAPERED ROLLER BEARINGS – INNER RING – Automotive Equipment Classes K and N (Metric)**

Inner Ring Bore		Shaft O.D.										
		Tolerance		Stationary Inner Ring			Rotating Inner Ring					
				Front Wheels Rear Wheel (Full-Floating Axles) Trailer Wheels			Rear Wheels (Semi-Floating Axles)			Rear Wheels (Unit-Bearing) (Semi-Floating Axles)		
				Non-adjustable			Non-adjustable			Non-adjustable		
Over	Incl.	Shaft O.D. Deviation	Resultant Fit	Symbol	Shaft O.D. Deviation	Resultant Fit	Symbol	Shaft O.D. Deviation	Resultant Fit	Symbol		
mm in.	mm in.	mm in.	mm in.	mm in.	mm in.	mm in.	mm in.	mm in.	mm in.	mm in.		
18.000 0.7087	30.000 1.1811	-0.012	-0.020	0.008L	f6	+0.035	0.047T	p6	+0.035	0.047T	p6	
		0.000	-0.033	0.033L		+0.022	0.022T		+0.022	0.022T		
		-0.0005	-0.0008	0.0003L		+0.0013	0.0018T		+0.0013	0.0018T		
		0.0000	-0.0013	0.0013L		+0.0008	0.0008T		+0.0008	0.0008T		
30.000 1.1811	50.000 1.9685	-0.012	-0.025	0.013L	f6	+0.042	0.054T	p6	+0.042	0.054T	p6	
		0.000	-0.041	0.041L		+0.026	0.026T		+0.026	0.026T		
		-0.0005	-0.0010	0.0005L		+0.0016	0.0021T		+0.0016	0.0021T		
		0.0000	-0.0016	0.0016L		+0.0010	0.0010T		+0.0010	0.0010T		
50.000 1.9685	80.000 3.1496	-0.015	-0.030	0.015L	f6	+0.051	0.066T	p6	-	-	-	
		0.000	-0.049	0.049L		+0.032	0.032T		+0.032	0.032T		
		-0.0006	-0.0012	0.0006L		+0.0021	0.0027T		+0.0021	0.0027T		
		0.0000	-0.0019	0.0019L		+0.0014	0.0014T					
80.000 3.1496	120.000 4.7244	-0.020	-0.035	0.016L	f6	+0.045	0.065T	n6	-	-	-	
		0.000	-0.058	0.058L		+0.023	0.023T		+0.023	0.023T		
		-0.0008	-0.0014	0.0006L		+0.0019	0.0027T		+0.0019	0.0027T		
		0.0000	-0.0023	0.0023L		+0.0010	0.0010T					
120.000 4.7244	180.000 7.0866	-0.025	-0.043	0.018L	f6	+0.052	0.077T	n6	-	-	-	
		0.000	-0.068	0.068L		+0.027	0.029T		+0.027	0.029T		
		-0.0010	-0.0016	0.0006L		+0.0022	0.0032T		+0.0022	0.0032T		
		0.0000	-0.0026	0.0026L		+0.0012	0.0012T					

These charts are guidelines for specifying shaft and housing fits related to particular operating conditions. Please contact your Timken engineer for more information.

Shaft O.D.													
Rotating Inner Ring													
Pinion									Differential		Transaxles, Transmissions Transfer Cases, Cross Shafts		
Clamped			Collapsible Spacer			Non-adjustable			Non-adjustable		Non-adjustable		
Shaft O.D. Deviation	Resultant Fit	Symbol	Shaft O.D. Deviation	Resultant Fit	Symbol	Shaft O.D. Deviation	Resultant Fit	Symbol	Shaft O.D. Deviation	Resultant Fit	Shaft O.D. Deviation	Resultant Fit	Symbol
mm in.	mm in.		mm in.	mm in.		mm in.	mm in.		mm in.	mm in.	mm in.	mm in.	
+0.015 +0.002 +0.0006 +0.0001	0.027T 0.002T	k6	+0.015 +0.002 +0.0006 +0.0001	0.027T 0.002T	k6	+0.035 +0.022 +0.0013 +0.0009	0.047T 0.022T	p6	+0.056 +0.035 +0.0022 +0.0014	0.068T 0.035T	+0.021 +0.008 +0.0008 +0.0003	0.033T 0.008T	m6
+0.018 +0.002 +0.0007 +0.0001	0.030T 0.002T	k6	+0.018 +0.002 +0.0007 +0.0001	0.030T 0.002T	k6	+0.042 +0.026 +0.0016 +0.0010	0.054T 0.026T	p6	+0.068 +0.043 +0.0028 +0.0018	0.080T 0.043T	+0.025 +0.009 +0.0010 +0.0004	0.037T 0.009T	m6
+0.021 +0.002 +0.0008 -0.0001	0.036T 0.002T	k6	+0.021 +0.002 +0.0008 +0.0001	0.036T 0.002T	k6	+0.051 +0.032 +0.021 +0.014	0.066T 0.032T	p6	+0.0089 +0.059 +0.0034 +0.0022	0.104T 0.059T	+0.030 +0.011 +0.0012 +0.0004	0.045T 0.011T	m6
+0.013 -0.009 +0.0005 -0.0004	0.033T 0.009L	j6	—	—	—	+0.045 +0.023 +0.0019 +0.0010	0.065T 0.023T	n6	+0.114 +0.079 +0.0044 +0.0030	0.134T 0.079T	+0.035 +0.013 +0.0014 +0.0005	0.055T 0.013T	m6
+0.014 -0.011 +0.0006 -0.0004	0.039T 0.011L	j6	—	—	—	+0.052 +0.028 +0.0022 +0.0012	0.077T 0.029T	n6	+0.140 +0.100 +0.0056 +0.0040	0.165T 0.100T	+0.040 +0.015 +0.0016 +0.0006	0.066T 0.015T	—

**FITTING PRACTICE TABLES**

These charts are guidelines for specifying shaft and housing fits related to particular operating conditions. Please contact your Timken engineer for more information.

**OUTER RING – Automotive Equipment  
Classes K and N (Metric)**

Deviation from nominal (maximum)  
bearing bore and resultant fit.

T= Tight  
L= Loose

**TABLE 29. TAPERED ROLLER BEARINGS – OUTER RING – Automotive Equipment Classes K and N (Metric)**

Outer Ring O.D.		Housing Bore																	
		Rotating Outer Ring			Stationary Outer Ring														
					Rear Wheels (Semi-Floating Axles)			Differential (Split Seat)			Transmissions Transfer Cases Cross Shafts			Pinion Differential (Solid Seat) Transaxles Transmission <sup>(1)</sup> Transfer Cases					
		Non-adjustable			Adjustable (TS) Clamped (TSU)			Adjustable			Adjustable			Non-adjustable					
Over	Incl.	Tolerance			Housing Bore	Resultant Fit	Symbol	Housing Bore	Resultant Fit	Symbol	Housing Bore	Resultant Fit	Symbol	Housing Bore	Resultant Fit	Symbol	Housing Bore	Resultant Fit	Symbol
mm in.	mm in.	mm in.	mm in.	mm in.	mm in.	mm in.	mm in.	mm in.	mm in.	mm in.	mm in.	mm in.	mm in.	mm in.	mm in.	mm in.	mm in.	mm in.	mm in.
30.000 1.1811	50.000 1.9685	0.000 -0.014 0.0000 -0.0006	-0.050 -0.025 -0.0020 -0.0010	0.050T 0.011T 0.0020T 0.0004T	R7	+0.009 +0.034 +0.0004 +0.0014	0.009L 0.048L 0.0004L 0.0020L	G7	0.000 +0.025 0.0000 +0.0010	0.000 0.039L 0.0000 0.0016L	H7	-0.013 +0.003 -0.0005 +0.0001	0.013T 0.017L 0.0005T 0.0007L	K6	-0.050 -0.025 -0.0020 -0.0010	0.050T 0.011T 0.0020T 0.0004T	R7		
50.000 1.9685	65.000 2.5591	0.000 -0.016 0.0000 -0.0006	-0.060 -0.030 -0.0023 -0.0011	0.060T 0.014T 0.0023T 0.0005T	R7	+0.010 +0.040 +0.0004 +0.0016	0.010L 0.056L 0.0004L 0.0022L	G7	0.000 +0.030 0.0000 +0.0012	0.000 0.046L 0.0000 0.0018L	H7	-0.015 +0.004 -0.0006 +0.0001	0.015T 0.020L 0.0006T 0.0007L	K6	-0.060 -0.030 -0.0023 -0.0011	0.060T 0.014T 0.0023T 0.0005T	R7		
65.000 2.5591	80.000 3.1496	0.000 -0.016 0.0000 -0.0006	-0.062 -0.032 -0.0023 -0.0011	0.062T 0.016T 0.0023T 0.0005T	R7	+0.012 +0.047 +0.0005 +0.0029	0.012L 0.065L 0.0005L 0.0026L	G7	0.000 +0.035 0.0000 +0.0014	0.000 0.053L 0.0000 0.0021L	H7	-0.018 +0.004 -0.0007 +0.0002	0.018T 0.022L 0.0007T 0.0009L	K6	-0.073 -0.038 -0.0029 -0.0015	0.073T 0.020T 0.0029T 0.0008T	R7		
80.000 3.1496	100.000 3.9370	0.000 -0.018 0.0000 -0.0007	-0.073 -0.038 -0.0029 -0.0015	0.073T 0.020T 0.0029T 0.0008T	R7	+0.014 +0.054 +0.0006 +0.0022	0.014L 0.074L 0.0006L 0.0030L	G7	-0.014 +0.026 -0.0006 +0.0010	0.014T 0.046L 0.0006L 0.0018L	J7	-0.021 +0.004 -0.0008 +0.0002	0.021T 0.024L 0.0008T 0.0010L	K6	-0.088 -0.048 -0.0035 -0.0019	0.088T 0.028T 0.0035T 0.0011T	R7		
100.000 3.9370	120.000 4.7244	0.000 -0.018 0.0000 -0.0007	-0.076 -0.041 -0.0029 -0.0015	0.076T 0.023T 0.0029T 0.0008T	R7	+0.014 +0.054 +0.0006 +0.0022	0.014L 0.074L 0.0006L 0.0030L	G7	-0.014 +0.026 -0.0006 +0.0010	0.014T 0.046L 0.0006L 0.0018L	J7	-0.021 +0.004 -0.0008 +0.0002	0.021T 0.024L 0.0008T 0.0010L	K6	-0.090 -0.050 -0.0035 -0.0019	0.090T 0.030T 0.0035T 0.0011T	R7		
120.000 4.7244	140.000 5.5118	0.000 -0.020 0.0000 -0.0008	-0.088 -0.048 -0.0035 -0.0019	0.088T 0.028T 0.0035T 0.0011T	R7	+0.014 +0.054 +0.0006 +0.0022	0.014L 0.074L 0.0006L 0.0030L	G7	-0.014 +0.026 -0.0006 +0.0010	0.014T 0.046L 0.0006L 0.0018L	J7	-0.021 +0.004 -0.0008 +0.0002	0.021T 0.024L 0.0008T 0.0010L	K6	-0.090 -0.050 -0.0035 -0.0019	0.090T 0.025T 0.0035T 0.0009T	R7		
140.000 5.5118	150.000 5.9055	0.000 -0.020 0.0000 -0.0008	-0.090 -0.050 -0.0035 -0.0019	0.090T 0.030T 0.0035T 0.0011T	R7	+0.014 +0.054 +0.0006 +0.0022	0.014L 0.074L 0.0006L 0.0030L	G7	-0.014 +0.026 -0.0006 +0.0010	0.014T 0.046L 0.0006L 0.0018L	J7	-0.021 +0.004 -0.0008 +0.0002	0.021T 0.024L 0.0008T 0.0010L	K6	-0.090 -0.050 -0.0035 -0.0019	0.090T 0.030T 0.0035T 0.0011T	R7		
150.000 5.9055	160.000 6.2992	0.000 -0.025 0.0000 -0.0010	-0.090 -0.050 -0.0035 -0.0019	0.090T 0.025T 0.0035T 0.0009T	R7	+0.014 +0.054 +0.0006 +0.0022	0.014L 0.074L 0.0006L 0.0030L	G7	-0.014 +0.026 -0.0006 +0.0010	0.014T 0.046L 0.0006L 0.0018L	J7	-0.021 +0.004 -0.0008 +0.0002	0.021T 0.029L 0.0008T 0.0012L	K6	-0.090 -0.050 -0.0035 -0.0019	0.090T 0.025T 0.0035T 0.0009T	R7		
160.000 6.2992	180.000 7.0866	0.000 -0.025 0.0000 -0.0010	-0.093 -0.053 -0.0035 -0.0019	0.093T 0.028T 0.0035T 0.0009T	R7	+0.014 +0.054 +0.0006 +0.0022	0.014L 0.074L 0.0006L 0.0030L	G7	-0.014 +0.026 -0.0006 +0.0010	0.014T 0.046L 0.0006L 0.0018L	J7	-0.021 +0.004 -0.0008 +0.0002	0.021T 0.029L 0.0008T 0.0012L	K6	-0.093 -0.053 -0.0035 -0.0019	0.093T 0.028T 0.0035T 0.0009T	R7		

<sup>(1)</sup>Aluminum housings min. fit of 0.025 mm (0.001 in.) per inch of outer ring O.D. Magnesium housing min. fit of 0.038 mm (0.0015 in.) per inch of outer ring O.D.

*Continued on next page.*

These charts are guidelines for specifying shaft and housing fits related to particular operating conditions. Please contact your Timken engineer for more information.

Table 29 continued.

Outer Ring O.D.		Housing Bore																		
		Rotating Outer Ring			Stationary Outer Ring															
					Rear Wheels (Semi-Floating Axles)			Differential (Split Seat)			Transmissions Transfer Cases Cross Shafts			Pinion Differential (Solid Seat) Transaxles Transmission <sup>(1)</sup> Transfer Cases						
		Non-adjustable			Adjustable (TS) Clamped (TSU)			Adjustable			Adjustable			Non-adjustable						
Over	Incl.	Tolerance			Housing Bore Deviation	Resultant Fit	Symbol	Housing Bore Deviation	Resultant Fit	Symbol	Housing Bore Deviation	Resultant Fit	Symbol	Housing Bore Deviation	Resultant Fit	Symbol	Housing Bore Deviation	Resultant Fit	Symbol	
mm in.	mm in.	mm in.	mm in.	mm in.	mm in.	mm in.	mm in.	mm in.	mm in.	mm in.	mm in.	mm in.	mm in.	mm in.	mm in.	mm in.	mm in.	mm in.	mm in.	
180.000 7.0866	200.000 7.8740	0.000 -0.030 0.0000 -0.0012	-0.106 -0.060 -0.0042 -0.0024	0.106T 0.030T 0.0042T 0.0012T																
200.000 7.8740	225.000 8.8583	0.000 -0.030 0.0000 -0.0012	-0.109 -0.063 -0.0042 -0.0024	0.109T 0.033T 0.0042T 0.0012T	R7	-	-	-	-0.016 +0.030 -0.0007 +0.0011	0.016T 0.060L 0.0007T 0.0023L	J7	-0.016 +0.030 -0.0007 +0.0011	0.016T 0.060L 0.0007T 0.0023L	J7	-0.109 -0.063 -0.0042 -0.0024	0.109T 0.033T 0.0042T 0.0012T	R7			
225.000 8.8583	250.000 9.8425	0.000 -0.030 0.0000 -0.0012	-0.113 -0.067 -0.0042 -0.0024	0.113T 0.037T 0.0042T 0.0012T																
250.000 9.8425	280.000 11.0236	0.000 -0.035 0.0000 -0.0014	-0.126 -0.074 -0.0047 -0.0027	0.126T 0.039T 0.0047T 0.0013T	R7	-	-	-	-0.016 +0.036 -0.0007 +0.0013	0.016T 0.071L 0.0007T 0.0027L	J7	-0.016 +0.036 -0.0007 +0.0014	0.016T 0.071L 0.0007T 0.0027L	J7	-0.126 -0.074 -0.0047 -0.0027	0.126T 0.039T 0.0047T 0.0013T	R7			
280.000 11.0236	315.000 12.4016	0.000 -0.035 0.0000 -0.0014	-0.130 -0.078 -0.0047 -0.0027	0.130T 0.043T 0.0047T 0.0013T																

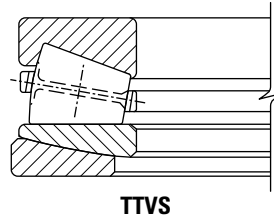
<sup>(1)</sup>Aluminum housings min. fit of 0.025 mm (0.001 in.) per inch of outer ring O.D. Magnesium housing min. fit of 0.038 mm (0.0015 in.) per inch of outer ring O.D.

FITTING PRACTICE TABLES

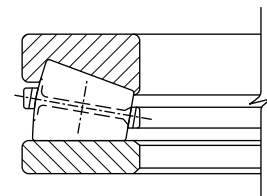
These charts are guidelines for specifying shaft and housing fits related to particular operating conditions. Please contact your Timken engineer for more information.

THRUST TAPERED ROLLER BEARINGS

Tolerances for housing bore and shaft diameters are shown as variance from nominal bearing dimension. When one ring is piloted by the housing, sufficient clearances must be allowed at the outside diameter of the other ring as well as at the bore of both rings to prevent cross-loading of the rollers. For most applications, this clearance is approximately 1/16 in. (1.588 mm, 0.0625 in.).



TTVS



TTHDFL

TABLE 30. THRUST TAPERED ROLLER BEARINGS TYPE TTVS AND TTHDFL – SHAFT DIAMETERS

Bearing Bore Nominal (Min.)		Shaft Diameter
Over	Incl.	Min. <sup>(1)</sup>
mm	mm	mm
in.	in.	in.
0.000 0.0000	304.800 12.0000	-0.051 -0.0020
304.800 12.0000	508.000 20.0000	-0.051 -0.0020
508.000 20.0000	711.200 28.0000	-0.076 -0.0030
711.200 28.0000	1219.200 48.0000	-0.102 -0.0040
1219.200 48.0000	1727.200 68.0000	-0.127 -0.0050

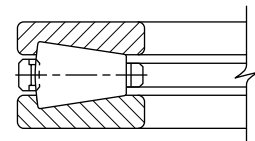
<sup>(1)</sup>Tolerance range is from +0 to value listed.

TABLE 31. THRUST TAPERED ROLLER BEARINGS TYPE TTVS AND TTHDFL – HOUSING DIAMETERS

Bearing Bore Nominal (Min.)		Housing Bore	
Over	Incl.	Max.	Min.
mm	mm	mm	mm
in.	in.	in.	in.
161.925 6.3750	265.113 10.4375	+0.060 +0.0025	+0.025 +0.0010
265.113 10.3475	317.500 12.5000	+0.076 +0.0030	+0.025 +0.0010
317.500 12.5000	482.600 19.0000	+0.102 +0.0040	+0.051 +0.0020
482.600 19.0000	603.250 23.7500	+0.113 +0.0045	+0.051 +0.0020
603.250 23.7500	711.200 28.0000	+0.152 +0.0060	+0.076 +0.0030
711.200 28.0000	838.200 33.0000	+0.178 +0.0070	+0.076 +0.0030

TABLE 32. THRUST TAPERED ROLLER BEARINGS – TTHD BEARINGS – FITTING GUIDELINES

Bore		Rotating Ring						Stationary Ring
		Tolerance	Class 2 Shaft O.D. Deviation	Resultant Fit	Tolerance	Class 3 Shaft O.D. Deviation	Resultant Fit	Class 2 and 3
Over	Incl.	mm	mm	mm	mm	mm	mm	
in.	in.	in.	in.	in.	in.	in.	in.	
0.000 0.0000	304.800 12.0000	0.000 +0.025 0.0000 +0.0010	+0.076 +0.050 +0.0030 +0.0020	0.076T 0.025T 0.0030T 0.0010T	0.000 +0.013 0.0000 +0.0005	+0.051 +0.038 +0.0020 +0.0015	0.051T 0.025T 0.0020T 0.0010T	All sizes
304.800 12.0000	609.600 24.0000	0.000 +0.051 0.0000 +0.0020	+0.152 +0.102 +0.0060 +0.0040	0.152T 0.051T 0.0060T 0.0020T	0.000 +0.025 0.0000 +0.0010	+0.102 +0.076 +0.0040 +0.0030	0.102T 0.051T 0.0040T 0.0020T	
609.600 24.0000	914.400 36.0000	0.000 +0.076 0.0000 +0.0030	+0.204 +0.127 +0.0080 +0.0050	0.204T 0.051T 0.0080T 0.0020T	0.000 +0.038 0.0000 +0.0015	+0.127 +0.089 +0.0050 +0.0035	0.127T 0.051T 0.0050T 0.0020T	
914.400 36.0000	1219.200 48.0000	0.000 +0.102 0.0000 +0.0040	+0.254 +0.153 +0.0100 +0.0060	0.254T 0.051T 0.0100T 0.0020T	0.000 +0.051 0.0000 +0.0020	+0.153 +0.102 +0.0060 +0.0040	0.153T 0.051T 0.0060T 0.0020T	
1219.200 48.0000		0.000 +0.127 0.0000 +0.0050	+0.305 +0.178 +0.0120 +0.0070	0.305T 0.051T 0.0120T 0.0020T	0.000 +0.076 0.0000 +0.0030	+0.204 +0.127 +0.0080 +0.0050	0.204T 0.051T 0.0080T 0.0020T	



TTHD

- Rotating ring O.D. must have a minimum radial clearance of 2.5 mm (0.1 in.).
  - TTHD stationary ring O.D. must have a minimum loose fit of 0.25 to 0.37 mm (0.01 to 0.015 in.).
  - TTHDFL ring when stationary may be loose fit on its O.D. (same as the TTHD) or may be 0.025 to 0.076 mm (0.001 to 0.003 in.) tight.
- Provide a minimum radial clearance of 2.5 mm (0.1 in.) between ring bore and shaft O.D.



## OPERATING TEMPERATURES

Bearings operate in a wide range of applications and environments. In most cases, bearing operating temperature is not an issue. Some applications, however, operate at extreme speeds or in extreme temperature environments. In these cases, care must be taken not to exceed the temperature limits of the bearing. Minimum temperature limits are primarily based on lubricant capability. Maximum temperature limits are most often based on material and/or lubricant constraints, but also may be based on accuracy requirements of the equipment that the bearings are built into. These constraints/limitations are discussed below.

## BEARING MATERIAL LIMITATIONS

Standard bearing steels with a standard heat treatment cannot maintain a minimum hardness of 58 HRC much above 120° C (250° F).

Dimensional stability of Timken bearings is managed through the proper selection of an appropriate heat-treat process. Standard Timken tapered roller and ball bearings are dimensionally stabilized from -54° C (-65° F) up to 120° C (250° F), while standard spherical roller bearings are dimensionally stabilized up to 200° C (392° F) and standard cylindrical roller bearings are stabilized up to 150° C (302° F). Upon request, these bearings can be ordered to higher levels of stability as listed below. These designations are in agreement with DIN Standard 623.

**TABLE 33.**

Stability Designation	Maximum Operating Temperature	
	°C	°F
S0	150	302
S1	200	392
S2	250	482
S3	300	572
S4	350	662

With dimensionally stabilized product, there still may be some changes in dimensions during service as a result of microstructural transformations. These transformations include the continued tempering of martensite and decomposition of retained austenite. The magnitude of change depends on the operating temperature, the time at temperature and the composition and heat-treatment of the steel.

Temperatures exceeding the limits shown in table 33 require special high-temperature steel. Consult your Timken engineer for availability of specific part numbers for non-standard heat stability or high-temperature steel grades.

Suggested materials for use in balls, rings and rollers at various operating temperatures are listed in table 34. Also listed are chemical composition recommendations, hardness recommendations and dimensional stability information.

Operating temperature affects lubricant film thickness and setting, both of which directly influence bearing life. Extremely high temperatures can result in a reduced film thickness that can lead to asperity contact between contacting surfaces.

Operating temperature also can affect performance of cages, seals and shields, which in turn can affect bearing performance. Materials for these components and their operating temperature ranges are shown in table 35.

## LUBRICATION LIMITATIONS

Starting torque in grease-lubricated applications typically increases significantly at cold temperatures. Starting torque is not primarily a function of the consistency or channel properties of the grease. Most often, it is a function of the rheological properties of the grease.

The high-temperature limit for greases is generally a function of the thermal and oxidation stability of the base oil in the grease and the effectiveness of the oxidation inhibitors.

See the LUBRICATION AND SEALS section on page 55 for more information on lubrication limitations.

## EQUIPMENT REQUIREMENTS

The equipment designer must evaluate the effects of temperature on the performance of the equipment being designed. Precision machine tool spindles, for example, can be very sensitive to thermal expansions. For some spindles, it is important that the temperature rise over ambient be held to 20° C to 35° C (36° F to 45° F).

Most industrial equipment can operate at considerably higher temperatures. Thermal ratings on gear drives, for example, are based on 93° C (200° F). Equipment such as gas turbines operates continuously at temperatures above 100° C (212° F). Running at high temperatures for extended periods of time, however, may affect shaft and housing fits, if the shaft and housing are not machined and heat-treated properly.

Although bearings can operate satisfactorily up to 120° C (250° F),

an upper temperature limit of 80° C to 95° C (176° F to 203° F) is more practical. Higher operating temperatures increase the risk of damage from transient temperature spikes. Prototype testing of the application can help define the operating temperature range and should be conducted if possible. It is the responsibility of the equipment designer to weigh all relevant factors and make the final determination of satisfactory operating temperature.

Tables 34 and 35 provide standard operating temperatures for common bearing component materials. They should be used for reference purposes only. Other bearing component materials are available on request. Contact your Timken engineer for more information.

**TABLE 34. OPERATING TEMPERATURES FOR BEARING COMPONENT MATERIALS**

Material	Approximate Chemical Analysis %	Temp. °F	Hardness HRC	-73° C	-54° C	-17° C	38° C	93° C	121° C	149° C	204° C	260° C	316° C	371° C	427° C
				-100° F	-65° F	0° F	100° F	200° F	250° F	300° F	400° F	500° F	600° F	700° F	800° F
Low-alloy carbon-chromium bearing steels. 52100 and others per ASTM A295	1C 0.5–1.5Cr 0.35Mn	70	60	STANDARD DIMENSIONAL STABILIZATION <0.0001 in./in dimensional change in 2500 hours at 100° C (212° F). Good oxidation resistance.											
Low-alloy carbon-chromium bearing steels. 52100 and others per ASTM A295	1C 0.5–1.5Cr 0.35Mn	70 350 450	58 56 54	Heat stabilized per FS136, <0.0001 in./in dimensional change in 2500 hours at 149° C (300° F). When given a stabilizing heat treatment, A295 steel is suitable for many applications in the 177°–232° C (350–450° F) range; however, it is not as dimensionally stable as it is at temperatures below 177° C (350° F). If utmost stability is required, use materials in the 316° C (600° F) group below.											
Deep-hardening steels for heavy sections per ASTM A485	1C 1–1.8Cr 1–1.5Mn .06Si	70 450 600	58 55 52	As heat-treated and tempered, it is stabilized, <0.0001 in./in dimensional change in 2500 hours at 149° C (300° F).											
Carburizing steels per ASTM A534 a) low alloy 4118, 8X19, 5019, 8620 (Ni-Moly grades) b) high nickel 3310	Ni-Moly: 0.2C, 0.4–2.0Mn, 0.3–0.8Cr, 0–2.0Ni, 0–0.3Mo .01C, 1.5Cr, 0.4Mn, 3.5Ni	70	58	Nickel-Moly grades of steel frequently used to achieve extra ductility in inner rings for locking device bearings. 3311 and others used for extra-thick-section rings.											
Corrosion-resistant 440C stainless steel per ASTM A756	1C 18Cr	70	58	Excellent corrosion resistance.											
Corrosion-resistant 440C stainless steel per ASTM A756	1C 18Cr	70 450 600	58 55 52	As heat stabilized for maximum hardness at high temperatures (FS238). Good oxidation resistance at higher temperatures. Note load capacity drops off more rapidly at higher temperatures than M50 shown below, which should be considered if loads are high, <0.0001 in./in dimensional change in 1200 hours.											
M-50 medium high speed	4Cr 4Mo 1V 0.8C	70 450 600	60 59 57	Suggested where stable high hardness at elevated temperature is required, <0.0001 in./in dimensional change in 1200 hours at 316° C (600° F).											

Note: Dimensional stability data shown above is the permanent metallurgical growth and/or shrinkage only. Thermal expansion effects are not included. For operating temperatures above 427° C (800° F), consult your Timken engineer.

TABLE 35. OPERATING TEMPERATURES FOR BEARING COMPONENT MATERIALS

	-54° C -65° F	-17° C 0° F	38° C 100° F	93° C 200° F	149° C 300° F	204° C 400° F	260° C 500° F	316° C 600° F	371° C 700° F	427° C 800° F
<b>CAGES</b>										
Molded 6/6 nylon (PRB)										
Molded 6/6 fiberglass reinforced nylon (PRC)										
Phenolic resin laminate										
Low-carbon pressed steel										
Pressed stainless steel										
Machined bronze										
Machined iron-silicon bronze										
Machined steel										
<b>SHIELDS</b>										
Low-carbon steel										
Stainless steel										
Nylon										
<b>SEALS</b>										
Buna N										
Polyacrylic										
Fluoroelastomer										
Stabilized TFE fluorocarbon <sup>(1)</sup>										
TFE fluorocarbon <sup>(1)</sup> (with glass fabric)										

<sup>(1)</sup>Limited life above these temperatures.

## HEAT GENERATION AND DISSIPATION

Bearing operating temperature is dependent upon a number of factors, including heat generation of all contributing heat sources, heat flow rate between sources and the ability of the system to dissipate the heat. Heat sources include such things as bearings, seals, gears, clutches and oil supply. Heat dissipation is affected by many factors, including shaft and housing materials and designs, lubricant circulation and external environmental conditions. These and other factors are discussed in the following sections.

### HEAT GENERATION

Under normal operating conditions, most of the torque and heat generated by the bearing is caused by the elastohydrodynamic losses at the roller/ring contacts.

Heat generation is the product of bearing torque and speed. The following equation is used to calculate the heat generated.

$$Q_{\text{gen}} = k_4 n M$$

If the bearing is tapered, the torque can be calculated using the following equation.

$$M = k_1 G_1 (n\mu)^{0.62} (P_{\text{eq}})^{0.3}$$

Where:

- $k_1$  = bearing torque constant  
=  $2.56 \times 10^{-6}$  for  $M$  in N-m  
=  $3.54 \times 10^{-5}$  for  $M$  in lbf-in.
- $k_4$  = 0.105 for  $Q_{\text{gen}}$  in W when  $M$  in N-m  
=  $6.73 \times 10^{-4}$  for  $Q_{\text{gen}}$  in Btu/min when  $M$  in lbf-in.

### HEAT DISSIPATION

The problem of determining the heat flow from a bearing in a specific application is rather complex. In general, it can be said that factors affecting the rate of heat dissipation include the following:

1. Temperature gradient from the bearing to the housing. This is affected by size configuration of the house and any external cooling such as fans, water cooling or fan action of the rotating components.
2. Temperature gradient from the bearing to the shaft. Any other heat sources, such as gears and additional bearings and their proximity to the bearing considered, will influence the temperature of the shaft.
3. The heat carried away by a circulating oil system.

To what extent nos. 1 and 2 can be controlled will depend on the application. The heat-dissipation modes include conduction through the system, convection along the inside and outside surfaces of the system, as well as radiation exchange to and from neighboring structures. In many applications, overall heat dissipation can be divided into two categories – heat removed by circulating oil and heat removed through the structure.

### Heat dissipation by circulating oil

The amount of heat removed by the lubricant can be controlled more easily. In a splash lubrication system, cooling coils may be used to control the bulk oil temperature.

The amount of heat carried away in a circulating oil system by the lubricant can be approximated from the following equations.

$$Q_{\text{oil}} = k_6 C_p \rho f (\theta_o - \theta_i)$$

Where:

- $k_6$  =  $1.67 \times 10^{-5}$  for  $Q_{\text{oil}}$  in W  
=  $1.67 \times 10^{-2}$  for  $Q_{\text{oil}}$  in Btu/min

If the circulating lubricant is petroleum oil, the heat removed is further approximated by the following:

$$Q_{\text{oil}} = k_5 f (\theta_o - \theta_i)$$

The following factors apply to the heat generation and dissipation equations listed on this page.

Where:

- $k_5$  = 28 for  $Q_{\text{oil}}$  in W when  $f$  in L/min and  $\theta$  in °C  
= 0.42 for  $Q_{\text{oil}}$  in Btu/min when  $f$  in U.S. pt/min and  $\theta$  in °F

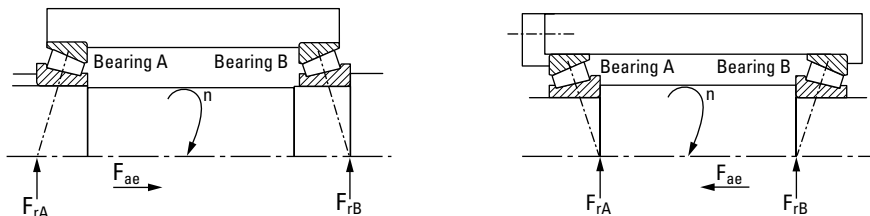
# TORQUE

## TAPERED ROLLER BEARINGS

### RUNNING TORQUE-M

The rotational resistance of a rolling bearing depends on load, speed, lubrication conditions and internal bearing characteristics.

The following formulas yield approximations to values of bearing running torque. The formulas apply to bearings lubricated by oil. For bearings lubricated by grease or oil mist, torque is usually lower, although for grease lubrication this depends on amount and consistency of the grease. The formulas also assume the bearing running torque has stabilized after an initial period referred to as running-in.



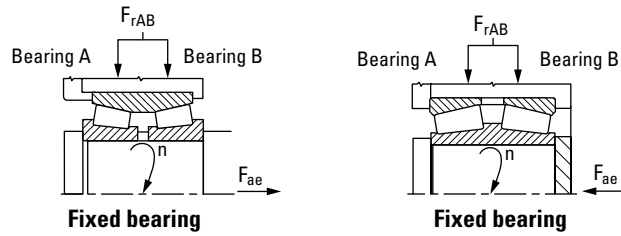
Design (external thrust,  $F_{ae}$ , onto bearing A)

Fig. 17. Single-row tapered roller bearing.

TABLE 36. VALUE APPROXIMATIONS OF BEARING RUNNING TORQUE

Thrust Condition	Net Bearing Thrust Load	
$\frac{0.47 F_{rA}}{K_A} \leq \frac{0.47 F_{rB}}{K_B} + F_{ae}$	$F_{aA} = \frac{0.47 F_{rB}}{K_B} + F_{ae}$  $F_{aB} = \frac{0.47 F_{rB}}{K_B}$	$M = k_1 G_1 (n\mu)^{0.62} \left( \frac{f_3 F_r}{K} \right)^{0.3}$  $n_{min} = \frac{k_2}{G_2 \mu} \left( \frac{f_2 F_r}{K} \right)^{2/3}$
$\frac{0.47 F_{rA}}{K_A} > \frac{0.47 F_{rB}}{K_B} + F_{ae}$	$F_{aA} = \frac{0.47 F_{rA}}{K_A}$  $F_{aB} = \frac{0.47 F_{rA}}{K_A} - F_{ae}$	

The torque equations will be underestimated if operating speed,  $n$ , is less than  $n_{min}$ . For values of  $f_1$  and  $f_2$ , refer to fig. 20 on page 53.



Design (external thrust,  $F_{ae}$ , onto bearing A)

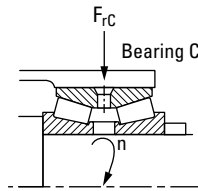
Fig. 18. Double-row tapered roller bearing.

TABLE 37. FIXED POSITION

Load Condition	Radial Load on Each Row $F_r$	
$F_{ae} > \frac{0.47 F_{rAB}}{K_A}$	Bearing B is unloaded $F_{rA} = F_{rAB}$ $F_{aA} = F_{ae}$	$M = k_1 G_1 (n\mu)^{0.62} \left( \frac{f_3 F_{rAB}}{K} \right)^{0.3}$ $n_{min} = \frac{k_2}{G_2\mu} \left( \frac{f_2 F_{rAB}}{K} \right)^{2/3}$
$F_{ae} \leq \frac{0.47 F_{rAB}}{K_A}$	$F_{rA} = \frac{F_{rAB}}{2} + 1.06 K F_{ae}$ $F_{rB} = \frac{F_{rAB}}{2} - 1.06 K F_{ae}$	$M = k_1 G_1 (n\mu)^{0.62} \left( \frac{0.060}{K} \right)^{0.3} (F_{rA}^{0.3} + F_{rB}^{0.3})$ $n_{minA} = \frac{k_2}{G_2\mu} \left( \frac{1.78 F_{rA}}{K} \right)^{2/3}; \quad n_{minB} = \frac{k_2}{G_2\mu} \left( \frac{1.78 F_{rB}}{K} \right)^{2/3}$

$$M = 2 k_1 G_1 (n\mu)^{0.62} \left( \frac{0.030 F_{rC}}{K} \right)^{0.3}$$

$$n_{min} = \frac{k_2}{G_2\mu} \left( \frac{0.890 F_r}{K} \right)^{2/3}$$



Floating bearing

The torque equations will be underestimated if operating speed,  $n$ , is less than  $n_{min}$ .  
For values of  $f_1$  and  $f_2$ , refer to fig. 20 on page 53.

Fig. 19. Floating position.

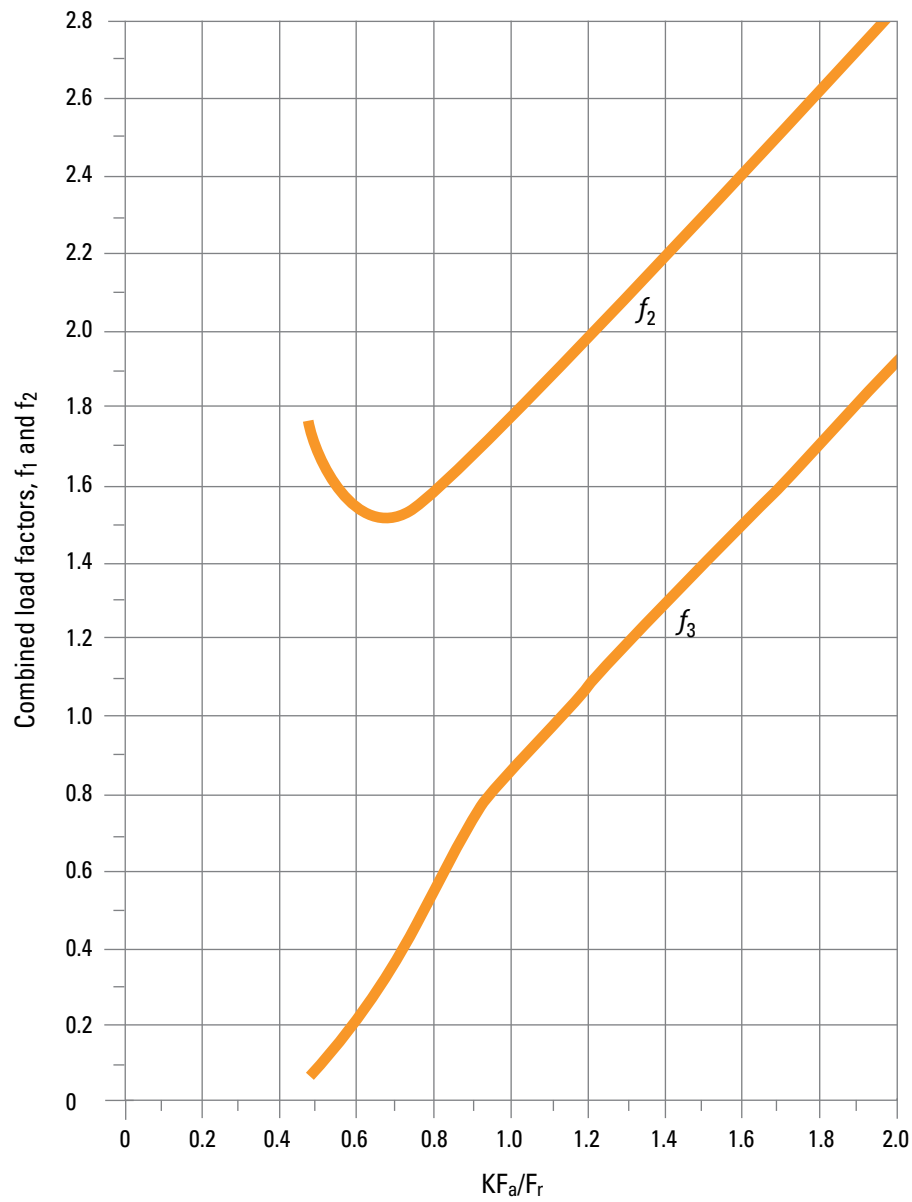
$k_1 = 2.56 \times 10^{-6}$  (metric) or  $3.54 \times 10^{-5}$  (inch)

$k_2 = 625$  (metric) or  $1700$  (inch)

$\mu$  = lubricant dynamic viscosity at operating temperature centipoise  
For grease, use the base oil viscosity.

$f_3$  = combined load factor, see fig. 20 on page 53

$f_2$  = combined load factor, see fig. 20 on page 53



Load Condition	$f_3$ and $f_2$
$KF_a/F_r > 2.0$	$f_3 = KF_a/F_r$ $f_2 = f_3 + 0.8$
$0.47 \leq KF_a/F_r \leq 2.0$	Use graph above
$KF_a/F_r < 0.47$	$f_3 = 0.06$ $f_2 = 1.78$

Fig. 20. Determination of combined load factors  $f_3$  and  $f_2$ .





## **LUBRICATION**

To help maintain a bearing's antifriction characteristics, lubrication is needed to:

- Minimize rolling resistance due to deformation of the rolling elements and raceway under load by separating the mating surfaces.
- Minimize sliding friction occurring between rolling elements, raceways and cage.
- Transfer heat (with oil lubrication).
- Protect from corrosion and, with grease lubrication, from contaminant ingress.



## LUBRICATION

The wide range of bearing types and operating conditions precludes any simple, all-inclusive statement or guideline allowing the selection of the proper lubricant. At the design level, the first consideration is whether oil or grease is best for the particular operation. The advantages of oil and grease are outlined in the table below. When heat must be carried away from the bearing, oil must be used. It is almost always preferred for very high-speed applications.

**TABLE 38. ADVANTAGES OF OIL AND GREASE**

Oil	Grease
Carries heat away from the bearings	Simplifies seal design and acts as a sealant
Carries away moisture and particulate matter	Permits prelubrication of sealed or shielded bearings
Easily controlled lubrication	Generally requires less frequent lubrication

### European REACH compliance

Timken-branded lubricants, greases and similar products sold in stand-alone containers or delivery systems are subject to the European REACH (**R**egistration, **E**valuation, **A**uthorization and **R**estriction of **C**hemicals) directive. For import into the European Union, Timken can sell and provide only those lubricants and greases that are registered with ECHA (**E**uropean **C**hemical **A**gency). For further information, please contact your Timken engineer.

## OIL LUBRICATION

Oils used for bearing lubrication should be high-quality mineral oils or synthetic oils with similar properties. Selection of the proper type of oils depends on bearing speed, load, operating temperature and lubrication method. Some features and advantages of oil lubrication, in addition to the above are:

- Oil is a better lubricant for high speeds or high temperatures. It can be cooled to help reduce bearing temperature.
- It is easier to handle and control the amount of lubricant reaching the bearing. It is harder to retain in the bearing. Lubricant losses may be higher than with grease.
- Oil can be introduced to the bearing in many ways, such as drip-feed, wick-feed, pressurized circulating systems, oil bath or air-oil mist. Each is suited for certain types of applications.
- Oil is easier to keep clean for recirculating systems.

Oil may be introduced to the bearing housing in many ways. The most common systems are:

- **Oil bath.** The housing is designed to provide a sump through which the rolling elements of the bearing will pass. Generally, the oil level should be no higher than the center

point of the lowest rolling element. If speed is high, lower oil levels should be used to reduce churning. Gages or controlled elevation drains are used to achieve and maintain the proper oil level.

- **Circulating system.** This system has the advantages of:
  - An adequate supply of oil for both cooling and lubrication.
  - Metered control of the quantity of oil delivered to each bearing.
  - Removal of contaminants and moisture from the bearing by flushing action.
  - Suitability for multiple bearing installations.
  - Large reservoir, which reduces deterioration. Increased lubricant life provides economical efficiency.
  - Incorporation of oil-filtering devices.
  - Positive control to deliver the lubricant where needed.
  - A typical circulating oil system consists of an oil reservoir, pump, piping and filter. A heat exchange may be required.
- **Oil-mist lubrication.** Oil-mist lubrication systems are used in high-speed, continuous-operation applications. This system permits close control of the amount of lubricant reaching the bearings. The oil may be metered, atomized by compressed air and mixed with air, or it may be picked up from a reservoir using a venturi effect. In either case, the air is filtered and supplied under sufficient pressure to assure adequate lubrication of the bearings. Control of this type of lubrication system is accomplished by monitoring the operating temperatures of the bearings being lubricated. The continuous passage of the pressurized air and oil through the labyrinth seals used in the system prevents the entrance of contaminants from the atmosphere to the system. The successful operation of this type of system is based upon the following factors:
  - Proper location of the lubricant entry ports in relation to the bearings being lubricated.
  - Avoidance of excessive pressure drops across void spaces within the system.
  - Proper air pressure and oil quantity ratio to suit the particular application.
  - Adequate exhaust of the air-oil mist after lubrication has been accomplished.

To ensure “wetting” of the bearings, and to prevent possible damage to the rolling elements and rings, it is imperative that the oil-mist system be turned on for several minutes before the equipment is started. The importance of “wetting” the bearing before starting cannot be overstated, and it also has particular significance for equipment that has been idled for extended periods of time.

Lubricating oils are commercially available in many forms for automotive, industrial, aircraft and other uses. Oils are classified as either petroleum types (refined from crude oil) or synthetic types (produced by chemical synthesis).

## PETROLEUM OILS

Petroleum oils are made from a petroleum hydrocarbon derived from crude oil, with additives to improve certain properties. Petroleum oils are used for nearly all oil-lubricated applications of bearings.

## SYNTHETIC OILS

Synthetic oils cover a broad range of categories and include polyalphaolefins, silicones, polyglycols and various esters. In general, synthetic oils are less prone to oxidation and can operate at extreme hot or cold temperatures. Physical properties, such as pressure-viscosity coefficients, tend to vary between oil types; use caution when making oil selections.

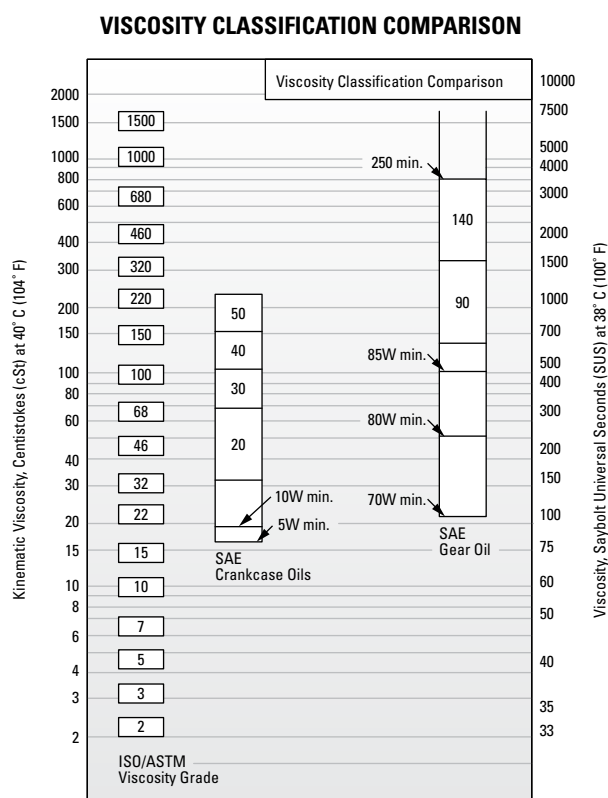
The polyalphaolefins (PAO) have a hydrocarbon chemistry that parallels petroleum oil both in chemical structures and pressure-viscosity coefficients. Therefore, PAO oil is mostly used in the oil-lubricated applications of bearings when severe temperature environments (hot and cold) are encountered or when extended lubricant life is required.

The silicone, ester and polyglycol oils have an oxygen-based chemistry that is structurally quite different from petroleum oils and PAO oils. This difference has a profound effect on its physical properties where pressure-viscosity coefficients can be lower compared to mineral and PAO oils. This means that these types of synthetic oils may actually generate a smaller elastohydrodynamic (EHD) film thickness than a mineral or PAO oil of equal viscosity at operating temperature. Reductions in bearing fatigue life and increases in bearing wear could result from this reduction of lubricant film thickness.

## VISCOSITY

The selection of oil viscosity for any bearing application requires consideration of several factors: load, speed, bearing setting, type of oil and environmental factors. Since oil viscosity varies inversely with temperature, a viscosity value must always be stated with the temperature at which it was determined. High-viscosity oil is used for low-speed or high-ambient-temperature applications. Low-viscosity oil is used for high-speed or low-ambient-temperature applications.

There are several classifications of oils based on viscosity grades. The most familiar are the Society of Automotive Engineers (SAE) classifications for automotive engine and gear oils. The American Society for Testing and Materials (ASTM) and the International Organization for Standardization (ISO) have adopted standard viscosity grades for industrial fluids. Fig. 21 shows the viscosity comparisons of ISO/ASTM with SAE classification systems at 40° C (104° F).



**Fig. 21. Comparison between ISO/ASTM grades (ISO 3448/ASTM D2442) and SAE grades (SAE J 300-80 for crankcase oils, SAE J 306-81 for axle and manual transmission oils).**

The ASTM/ISO viscosity grade system for industrial oils is depicted below.

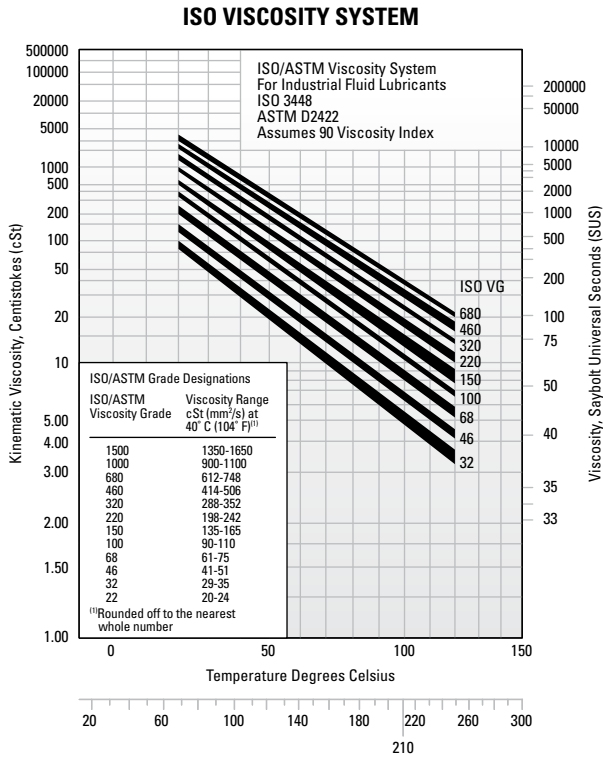


Fig. 22. Viscosity grade system for industrial oils.

### TYPICAL BEARING LUBRICATION OILS

In this section, the properties and characteristics of lubricants for typical roller bearing applications are listed. These general characteristics are derived from successful performance in applications across all industries.

### General-purpose rust and oxidation lubricating oil

General-purpose rust and oxidation (R&O) inhibited oils are the most common type of industrial lubricant. They are used to lubricate Timken® bearings in all types of industrial applications where conditions requiring special considerations do not exist.

TABLE 39. SUGGESTED GENERAL PURPOSE R&O LUBRICATING OIL PROPERTIES

Properties	
Base stock	Solvent-refined, high-viscosity-index petroleum oil
Additives	Corrosion and oxidation inhibitors
Viscosity index	80 min.
Pour point	-10° C max. (14° F)
Viscosity grades	ISO/ASTM 32 through 220

Some low-speed and/or high-ambient-temperature applications require the higher viscosity grades. High-speed and/or low-temperature applications require the lower viscosity grades.

### Industrial extreme-pressure (EP) gear oil

Extreme-pressure gear oils are used to lubricate Timken bearings in most types of heavily loaded industrial equipment. They should be capable of withstanding abnormal shock loads that are common in heavy-duty equipment.

TABLE 40. SUGGESTED INDUSTRIAL EP GEAR OIL PROPERTIES

Properties	
Base stock	Solvent-refined, high-viscosity-index petroleum oil
Additives	Corrosion and oxidation inhibitors Extreme-pressure (EP) additive <sup>(1)</sup> - 15.8 kg (35 lb.) min.
Viscosity index	80 min.
Pour point	-10° C max. (14° F)
Viscosity grades	ISO/ASTM 100, 150, 220, 320, 460

<sup>(1)</sup> ASTM D 2782

Industrial EP gear oils should be composed of a highly refined petroleum oil-based stock plus appropriate inhibitors and additives. They should not contain materials that are corrosive or abrasive to bearings. The inhibitors should provide long-term protection from oxidation and protect the bearing from corrosion in the presence of moisture. The oils should resist foaming in service and have good water-separation properties. An EP additive protects against scoring under boundary-lubrication conditions. The viscosity grades suggested represent a wide range. High-temperature and/or slow-speed applications generally require the higher viscosity grades. Low temperatures and/or high speeds require the use of lower viscosity grades.

## GREASE LUBRICATION

Grease lubrication is generally applicable to low-to-moderate speed applications that have operating temperatures within the limits of the grease. There is no universal anti-friction bearing grease. Each grease has limiting properties and characteristics.

Greases consist of a base oil, a thickening agent and additives. Conventionally, bearing greases have consisted of petroleum base oils thickened to the desired consistency by some form of metallic soap. More recently synthetic base oils have been used with organic and inorganic thickeners. Table 41 summarizes the composition of typical lubricating greases.

**TABLE 41. COMPOSITION OF GREASES**

Base Oil	Thickening Agents	Additives	Lubricating Grease
Mineral oil	Soaps and complex soaps <sup>+</sup>	Rust inhibitors <sup>=</sup>	
Synthetic hydrocarbon	lithium, aluminum, barium, calcium	Dyes	
Esters	Non-Soap (inorganic)	Tactifiers	
Perfluorinated oil	microgel (clay), carbon black,	Metal deactivates	
Silicone	silica-gel, PTFE	Oxidation inhibitors	
	Non-Soap (organic)	Anti-wear EP	
	Polyurea compounds		

Calcium- and aluminum-based greases have excellent water resistance and are used in industrial applications where water ingress is an issue. Lithium-based greases are multi-purpose and are used in industrial applications and wheel bearings.

Synthetic base oils such as esters, organic esters and silicones used with conventional thickeners and additives typically have higher maximum operating temperatures than petroleum-based greases. Synthetic greases can be designed to operate in temperatures from -73° C (-100° F) to 288° C (550° F).

Below are the general characteristics of common thickeners used with petroleum base oils.

**TABLE 42. GENERAL CHARACTERISTICS OF THICKENERS USED WITH PETROLEUM BASE OILS**

Thickener	Typical Dropping Point		Maximum Temperature		Typical Water Resistance
	°C	°F	°C	°F	
Lithium soap	193	380	121	250	Good
Lithium complex	260+	500+	149	300	Good
Aluminum complex	249	480	149	300	Excellent
Calcium sulfonate	299	570	177	350	Excellent
Polyurea	260	500	149	300	Good

Use of the thickeners in table 42 with synthetic hydrocarbon or

ester base oils increases the maximum operating temperature by approximately 10° C (50° F).

Using polyurea as a thickener for lubricating fluids is one of the most significant lubrication developments in more than 30 years. Polyurea grease performance is outstanding in a wide range of bearing applications and, in a relatively short time, it has gained acceptance as a factory-packed lubricant for ball bearings.

## LOW TEMPERATURES

Starting torque in a grease-lubricated bearing at low temperatures can be critical. Some greases may function adequately as long as the bearing is operating, but resistance to initial movement may be excessive. In certain smaller machines, starting may be impossible when very cold. Under such operating circumstances, greases containing low-temperature characteristic oils are generally required.

If the operating temperature range is wide, synthetic greases offer advantages. Synthetic greases are available to provide very low starting and running torque at temperatures as low as -73° C (-100° F). In certain instances, these greases perform better in this respect than oil.

An important point concerning lubricating greases is that the starting torque is not necessarily a function of the consistency or the channel properties of the grease. Starting torque is more a function of the individual rheological properties of a particular grease and is best evaluated by application experience.

## HIGH TEMPERATURES

The high temperature limit for lubricating greases is generally a function of the thermal and oxidation stability of the fluid and the effectiveness of the oxidation inhibitors. Grease temperature ranges are defined by both the dropping point of the grease thickener and composition of the base oil. Table 43 shows the temperature ranges of various base oils used in grease formulations.

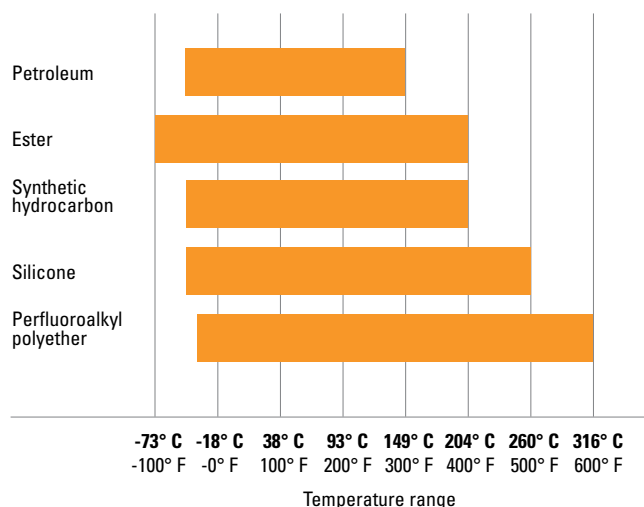
A rule of thumb, developed from years of testing grease-lubricated bearings, indicates that grease life is halved for every 10° C (50° F) increase in temperature. For example, if a particular grease provides 2000 hours of life at 90° C (194° F), by raising the temperature to 100° C (212° F), reduction in life to approximately 1000 hours would result. On the other hand, 4000 hours could be expected by lowering the temperature to 80° C (176° F).

Thermal stability, oxidation resistance and temperature limitations



must be considered when selecting greases for high-temperature applications. In non-relubricatable applications, highly refined mineral oils or chemically stable synthetic fluids are required as the oil component of greases for operation at temperatures above 121° C (250° F).

**TABLE 43. TEMPERATURE RANGES FOR BASE OILS USED IN LUBRICATING GREASES**



**CONTAMINATION**

**Abrasive Particles**

When roller bearings operate in a clean environment, the primary cause of damage is the eventual fatigue of the surfaces where rolling contact occurs. However, when particle contamination enters the bearing system, it is likely to cause damage such as bruising, which can shorten bearing life.

When dirt from the environment or metallic wear debris from some component in the application are allowed to contaminate the lubricant, wear can become the predominant cause of bearing damage. If bearing wear becomes significant, changes will occur to critical bearing dimensions that could adversely affect machine operation.

Bearings operating in a contaminated lubricant exhibit a higher initial rate of wear than those running in an uncontaminated lubricant. With no further contaminant ingress, this wear rate quickly diminishes. The contamination particles are reduced in size as they pass through the bearing contact area during normal operation.

**Water**

Water and moisture can be particularly conducive to bearing damage. Lubricating greases may provide a measure of protection from this contamination. Certain greases, such as calcium and aluminum-complex, are highly water-resistant.

Sodium-soap greases are water-soluble and should not be used in applications involving water.

Either dissolved or suspended water in lubricating oils can exert a detrimental influence on bearing fatigue life. Water can cause bearing etching that also can reduce bearing fatigue life. The exact mechanism by which water lowers fatigue life is not fully understood. It has been suggested that water enters micro-cracks in the bearing rings that are caused by repeated stress cycles. This leads to corrosion and hydrogen embrittlement in the micro-cracks, reducing the time required for these cracks to propagate to an unacceptable-sized spall.

Water-based fluids, such as water glycol and invert emulsions, also have shown a reduction in bearing fatigue life. Although water from these sources is not the same as contamination, the results support the previous discussion concerning water-contaminated lubricants.

**GREASE SELECTION**

The successful use of bearing grease depends on the physical and chemical properties of the lubricant as well as application and environmental conditions. Because the choice of grease for a particular bearing under certain service conditions is often difficult to make, you should consult with your lubricant supplier or equipment maker for specific questions about lubrication requirements for your application. You also can contact your Timken engineer for general lubrication guidelines for any application.

Grease must be carefully selected with regard to its consistency at operating temperature. It should not exhibit thickening, separation of oil, acid formation or hardening to any marked degree. It should be smooth, non-fibrous and entirely free from chemically active ingredients. Its dropping point should be considerably higher than the operating temperature.

Timken® application-specific lubricants were developed by leveraging our knowledge of tribology and anti-friction bearings, and how these two elements affect overall system performance. Timken lubricants help bearings and related components operate effectively in demanding industrial operations. High-temperature, anti-wear and water-resistant additives offer superior protection in challenging environments. Table 44 provides an overview of the Timken greases available for general applications. Contact your Timken engineer for a more detailed publication on Timken lubrication solutions.

**TABLE 44. GREASE LUBRICATION SELECTION GUIDE**



This selection guide is not intended to replace the specifications by the equipment builder, who is responsible for its performance.

Many bearing applications require lubricants with special properties or lubricants formulated specifically for certain environments, such as:

- Friction oxidation (fretting corrosion).
- Chemical and solvent resistance.
- Food handling.
- Quiet running.
- Space and/or vacuum.
- Electrical conductivity.

For assistance with these or other areas requiring special lubricants, consult your Timken engineer.

## GREASE USE GUIDELINES

It is important to use the proper amount of grease in the application. In typical industrial applications, the bearing cavity should be kept approximately one-third to one-half full. Less grease may result in the bearing being starved for lubrication. More grease may result in churning. Both conditions may result in excessive heat generation. As the grease temperature rises, viscosity decreases and the grease becomes thinner. This can reduce the lubricating effect and increase leakage of the grease from the bearing. It also may cause the grease components to separate, leading to a general breakdown of the lubricant properties. As the grease breaks down, bearing torque increases. In the case of excess grease resulting in churning, torque may also increase due to the resistance caused by the grease.

For best results, there should be ample space in the housing to allow room for excess grease to be thrown from the bearing. However, it is equally important that the grease be retained all around the bearing. If a large void exists between the bearings, grease closures should be used to prevent the grease from leaving the bearing area.

Only in low-speed applications may the housing be entirely filled with grease. This method of lubrication is a safeguard against the entry of foreign matter, where sealing provisions are inadequate for exclusion of contaminants or moisture.

During periods of non-operation, it is often wise to completely fill the housings with grease to protect the bearing surfaces. Prior to restarting operation, remove the excess grease and restore the proper level.

Applications utilizing grease lubrication should have a grease fitting and a vent at opposite ends of the housing near the top. A drain plug should be located near the bottom of the housing to allow the old grease to purge from the bearing.

Bearings should be relubricated at regular intervals to help prevent damage. Relubrication intervals are difficult to determine. If plant practice or experience with other applications is not available, consult your lubricant supplier.

Timken offers a range of lubricants to help bearings and related components operate effectively in demanding industrial operations. High-temperature, anti-wear and water-resistant additives offer greater protection in challenging environments. Timken also offers a line of single- and multi-point lubricators to simplify grease delivery.



**Fig. 23. Grease can easily be packed by hand.**



**Fig. 24. Mechanical grease packer.**

## Grease application methods

Grease, in general, is easier to use than oil in industrial bearing lubrication applications. Most bearings that are initially packed with grease require periodic relubrication to operate efficiently.

Grease should be packed into the bearing so that it gets between the rolling elements – the rollers or balls. For tapered roller bearings, forcing grease through the bearing from the large end to the small end will ensure proper distribution.

Grease can be easily packed into small- and medium-size bearings by hand (fig. 23). In shops where bearings are frequently regreased, a mechanical grease packer that forces grease through the bearing under pressure may be appropriate (fig. 24). Regardless of the method, after packing the internal areas of the bearing, a small amount of grease also should be smeared on the outside of the rollers or balls.

The two primary considerations that determine the relubrication cycle are operating temperature and sealing efficiency. High-operating-temperature applications generally require more frequent regreasing. The less efficient the seals, the greater the grease loss and the more frequently grease must be added.

Grease should be added any time the amount in the bearing falls below the desired amount. The grease should be replaced when its lubrication properties have been reduced through contamination, high temperature, water, oxidation or any other factors. For additional information on appropriate regreasing cycles, consult with the equipment manufacturer or your Timken engineer.



## Prelubricated bearings

Prelubricated shielded and sealed bearings are successfully used in applications where:

- Grease might be injurious to other parts of the mechanism.
- Cost and space limitations preclude the use of a grease-filled housing.
- Housings cannot be kept free of dirt and grit, water or other contaminants.
- Relubrication is impossible or would be a hazard to satisfactory use.

Prelubricated bearings are pre-packed with greases that have chemical and mechanical stability, and they have demonstrated long-life characteristics in rotating bearings. Greases are filtered several times to remove all harmful material, and they are accurately metered so that each bearing receives the proper amount of grease.

## CONSISTENCY

Greases may vary in consistency from semi-fluids that are hardly thicker than a viscous oil to solid grades almost as hard as a soft wood.

Consistency is measured by a penetrometer in which a standard weighted cone is dropped into the grease. The distance the cone penetrates (measured in tenths of a millimeter in a specific time) is the penetration number.

The National Lubricating Grease Institute (NLGI) classification of grease consistency is shown below:

**TABLE 45. NLGI CLASSIFICATIONS**

NLGI Grease Grades	Penetration Number
0	355-385
1	310-340
2	265-295
3	220-250
4	175-205
5	130-160
6	85-115

Grease consistency is not fixed; it normally becomes softer when sheared or “worked.” In the laboratory, this “working” is accomplished by forcing a perforated plate up and down through a closed container of grease. This “working” does not compare with the violent shearing action that takes place in a bearing and does not necessarily correlate with actual performance.

TABLE 46. GREASE COMPATIBILITY CHART

	Aluminum Complex	Barium Complex	Calcium Stearate	Calcium 12 Hydroxy	Calcium Complex	Calcium Sulfonate	Clay Non-Soap	Lithium Stearate	Lithium 12 Hydroxy	Lithium Complex	Polyurea Conventional	Polyurea Shear Stable
Aluminum Complex	Best Choice	Incompatible	Incompatible	Compatible	Incompatible	Borderline	Incompatible	Incompatible	Incompatible	Compatible	Incompatible	Compatible
Timken Food Safe Grease	Best Choice	Incompatible	Incompatible	Compatible	Incompatible	Borderline	Incompatible	Incompatible	Incompatible	Compatible	Incompatible	Compatible
Barium Complex	Incompatible	Best Choice	Incompatible	Compatible	Incompatible	Compatible	Incompatible	Incompatible	Incompatible	Incompatible	Incompatible	Borderline
Calcium Stearate	Incompatible	Incompatible	Best Choice	Compatible	Incompatible	Compatible	Compatible	Compatible	Borderline	Compatible	Incompatible	Compatible
Calcium 12 Hydroxy	Compatible	Compatible	Compatible	Best Choice	Borderline	Borderline	Compatible	Compatible	Compatible	Compatible	Incompatible	Compatible
Calcium Complex	Incompatible	Incompatible	Incompatible	Borderline	Best Choice	Incompatible	Incompatible	Incompatible	Incompatible	Compatible	Compatible	Compatible
Calcium Sulfonate	Borderline	Compatible	Compatible	Borderline	Incompatible	Best Choice	Incompatible	Borderline	Borderline	Compatible	Incompatible	Compatible
Timken Construction and Off-Highway Grease	Borderline	Compatible	Compatible	Borderline	Incompatible	Best Choice	Incompatible	Borderline	Borderline	Compatible	Incompatible	Compatible
Timken Mill Grease	Borderline	Compatible	Compatible	Borderline	Incompatible	Best Choice	Incompatible	Borderline	Borderline	Compatible	Incompatible	Compatible
Clay Non-Soap	Incompatible	Incompatible	Compatible	Compatible	Incompatible	Incompatible	Best Choice	Incompatible	Incompatible	Incompatible	Incompatible	Borderline
Lithium Stearate	Incompatible	Incompatible	Compatible	Compatible	Incompatible	Borderline	Incompatible	Best Choice	Compatible	Compatible	Incompatible	Compatible
Lithium 12 Hydroxy	Incompatible	Incompatible	Borderline	Compatible	Incompatible	Borderline	Incompatible	Compatible	Best Choice	Compatible	Incompatible	Compatible
Timken Multi-Use	Incompatible	Incompatible	Borderline	Compatible	Incompatible	Borderline	Incompatible	Compatible	Best Choice	Compatible	Incompatible	Compatible
Lithium Complex	Compatible	Incompatible	Compatible	Compatible	Incompatible	Compatible	Incompatible	Compatible	Compatible	Best Choice	Incompatible	Compatible
Timken All -Purpose Timken Synthetic	Compatible	Incompatible	Compatible	Compatible	Incompatible	Compatible	Incompatible	Compatible	Compatible	Best Choice	Incompatible	Compatible
High Performance Roller Housed Unit Grease	Compatible	Incompatible	Compatible	Compatible	Incompatible	Compatible	Incompatible	Compatible	Compatible	Best Choice	Incompatible	Compatible
Timken Premium All Purpose Industrial LC-2 Grease	Compatible	Incompatible	Compatible	Compatible	Incompatible	Compatible	Incompatible	Compatible	Compatible	Best Choice	Incompatible	Compatible
Polyurea Conventional	Incompatible	Incompatible	Incompatible	Incompatible	Compatible	Incompatible	Incompatible	Incompatible	Incompatible	Incompatible	Best Choice	Compatible
Polyurea Shear Stable	Compatible	Borderline	Compatible	Compatible	Compatible	Compatible	Borderline	Compatible	Compatible	Compatible	Compatible	Best Choice
Timken Pillow Block	Compatible	Borderline	Compatible	Compatible	Compatible	Compatible	Borderline	Compatible	Compatible	Compatible	Compatible	Best Choice

## TAPERED ROLLER BEARINGS

Timken offers the most extensive line of tapered roller bearings in the world. Tapered roller bearings consist of four interdependent components: the cone (inner ring), the cup (outer ring), the tapered rollers (rolling elements) and the cage (roller retainer). Tapered roller bearings are uniquely designed to manage both thrust and radial loads between a rotating and non-rotating member. The steeper the cup angle, the greater the ability of the bearing to handle thrust loads.

- **Sizes:** 8 mm (0.315 in.) bore to 3000 mm (118 in.) outside diameter (O.D.).
- **Industries:** Aerospace, agriculture, automotive, heavy truck, cement, aggregate, coal, oil and gas, construction, gear drives, machine tools, mining, paper, metals, rail and wind.
- **Features:** Available in single-, double- and four-row configurations. Refer to [www.timken.com](http://www.timken.com) for four-row information. Customized designs and features are available upon request.
- **Benefits:** Enhanced performance in demanding applications.



### TAPERED ROLLER BEARINGS

Part-Numbering Systems ..... 66

#### Radial Roller Bearings

##### Single-Row

TS ..... 81

Metric ..... 393

TSF ..... 433

TSL ..... 505

##### Double-Row

TDO ..... 509

TDI ..... 609

TDIT ..... 640

TNA ..... 647

TNASW ..... 659

TNASWE ..... 664

2TS-IM ..... 670

2TS-DM ..... 698

2S ..... 722

SR ..... 726

### Tapered Roller Thrust Bearings

Part-Numbering Systems ..... 736

TTHD ..... 737

TTHDFL ..... 738

TTVS ..... 740

TTSP ..... 741

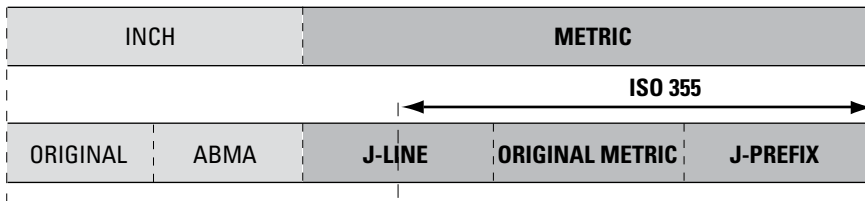
TTC, TTCS, TCL ..... 744

**Auxiliary Parts** ..... 747

# ***PART-NUMBERING SYSTEMS FOR RADIAL TAPERED ROLLER BEARINGS***

## **HOW TO IDENTIFY YOUR PART NUMBER**

The part-numbering systems for single-row radial tapered roller bearings (type TS) are internationally recognized. Several part-numbering systems have been developed that can be classified according to metric or inch systems. Inch system bearings are normally assigned individual part numbers for the inner ring and for the outer ring, whereas ISO (metric) bearings are assigned a unique part number for the bearing assembly as a whole, which includes both inner and outer ring.



NOTE: ISO 355 is a dimensional plan for metric tapered roller bearings. See page 72 for more details on ISO 355.

**Fig. 25. Part-numbering standards.**

### **BEARING SERIES**

In all the part-numbering systems, the term bearing series is used to describe bearings having the same basic internal geometry (e.g. roller size, inner-ring and outer-ring angles). Any inner ring (including roller set) can be matched with any outer ring within the same series providing that the same type of bearing is being used.

### **INCH PART-NUMBERING SYSTEMS**

#### **ORIGINAL INCH PART-NUMBERING SYSTEM**

The original system developed by The Timken Company was based on a family of bearings designed around a common roller. Varying the number of rollers and the angle of the raceways allows different bearings to be designed for predominantly radial loads (shallow angle) or thrust loads (steep angle).

For example, all the tapered roller bearings in the 500 family use the same roller. However, the 595 Series has a steep angle and 24 rollers while the 525 Series has a shallow angle and 15 rollers.

Individual part numbers are assigned to the inner and outer rings. Although there are exceptions, the general rule is that the outer ring has a part number that is lower than that of the inner ring.

## ABMA INCH PART-NUMBERING SYSTEM

The current inch part-numbering system was developed by the American Bearing Manufacturers Association (ABMA) to address the expansion in the number of new applications and tapered roller-bearing designs. This part-numbering system has become the international standard for inch-sized bearings.

The ABMA part-numbering system has been applied only to new bearing series designed after its introduction. Other part-numbering systems also are in use including those based on the original numbering system and proprietary part numbers for special bearings.

The ABMA part number is divided into five alphanumeric sections, which are described in fig. 26.

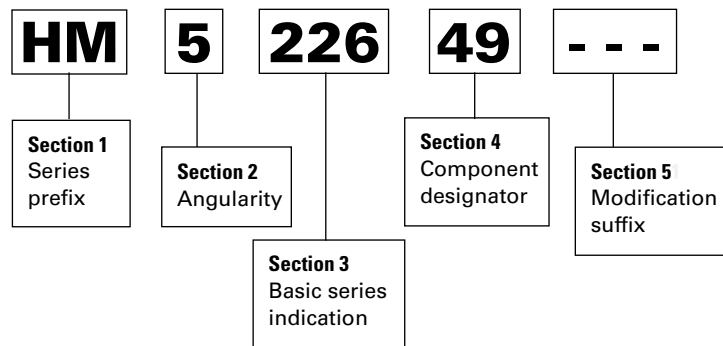


Fig. 26. ABMA inch part-numbering system nomenclature.

### Section 1 - Series prefix

The series prefix consists of one or two letters that designate the duty class for which the bearing is designed. Additional prefix letters are available in table 49 on page 74.

TABLE 47. COMMON PREFIX LETTERS

Prefix	Class Designation	Prefix	Class Designation
EL	Extra light	HM	Heavy medium
LL	Lighter than light	H	Heavy
L	Light	HH	Heavier than heavy
LM	Light medium	EH	Extra heavy
M	Medium	T	Thrust only

### Section 2 - Angularity designator

The first digit following the prefix represents the angle coding as determined by the included angle of the outer ring.

TABLE 48. ANGULARITY DESIGNATOR

Included Outer-Ring Angle	Code
0° to 23° 59' 59.99 in.	1
24° to 25° 29' 59.99 in.	2
25° 30' to 26° 59' 59.99 in.	3
27° to 28° 29' 59.99 in.	4
28° 30' to 30° 29' 59.99 in.	5
30° 30' to 32° 29' 59.99 in.	6
32° 30' to 35° 59' 59.99 in.	7
36° to 44° 59' 59.99 in.	8
45° and over; excluding thrust	9

### **Section 3 - Basic series indication**

The two or three digits following the angularity designator are reserved for the basic series indication. Refer to ABMA standard 19.2 for more information.

### **Section 4 - Component designator**

The last two numerical digits indicate the component number.

### **Section 5 - Modification suffix letters**

The suffix may consist of one to three letters in pre-arranged combinations, indicating modifications in external form or internal arrangement. Table 49 on page 74 lists the most common prefix and suffix designations.

## METRIC PART-NUMBERING SYSTEMS

### J-LINE PART NUMBERS

Some ABMA (inch) part numbers are designed with metric envelope dimensions. The J prefix letter is used in conjunction with the ABMA part-numbering system to identify metric-dimensioned and toleranced inner rings and outer rings. The J-prefix is shown before the ABMA prefix letters. J-Line bearings are referred to as inch bearings in metric bore, O.D. and width.

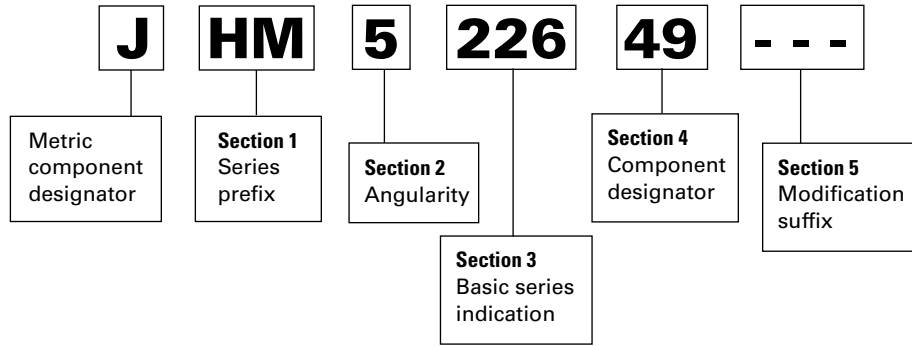


Fig. 27. J-Line part-numbering system nomenclature.

### J-PREFIX

A range of metric bearings originally designed by The Timken Company also were included in the ISO 355 plan. These bearings are specifically application-oriented and are designed for optimum performance. Depending on application and type of load, thrust and/or radial, the bearing with the optimum angle and section can be selected. For example, pinion bearings have a steep angle, whereas bearings for machine tools are generally designed with a shallow angle and a light section. Fig. 29 demonstrates this feature for 55 mm (2.1654 in.) bore bearings.

These bearings also are identified with a J-prefix, which indicates a metric dimensioned and toleranced bearing.

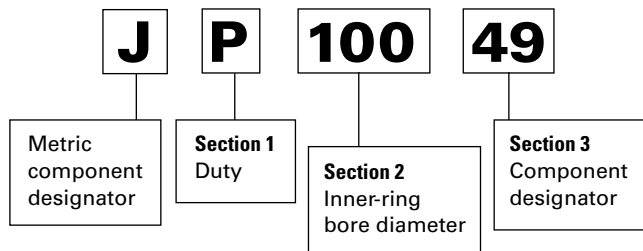


Fig. 28. J-prefix part-numbering system nomenclature.

#### Section 1 - Duty

Indicates application type:

- C, D & F = general purpose
- N = combination of general purpose and pinion
- P = high speed
- S & T = pinions
- W = high axial loads

#### Section 2 - Inner-ring bore

The inner-ring bore metric diameter is included in the part-number designation of both the inner ring and outer rings.

#### Section 3 - Component designator

Same identification as in the ABMA part-numbering system.

# TAPERED ROLLER BEARINGS

## PART-NUMBERING SYSTEMS

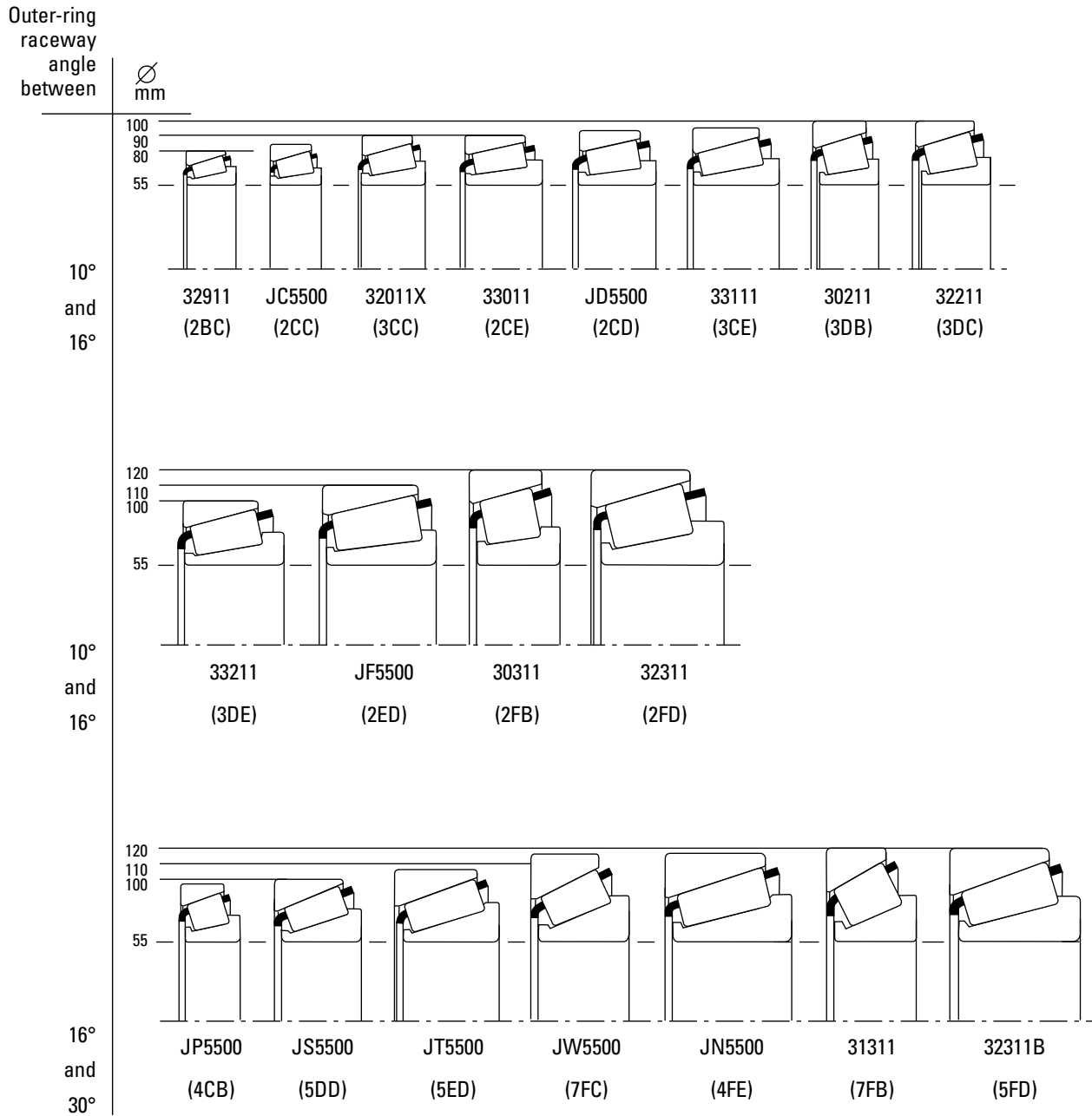
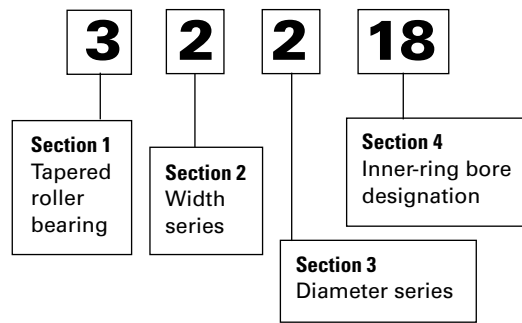


Fig. 29. Comparison of metric bearing designs for 55 mm (2.1654 in.) bore.

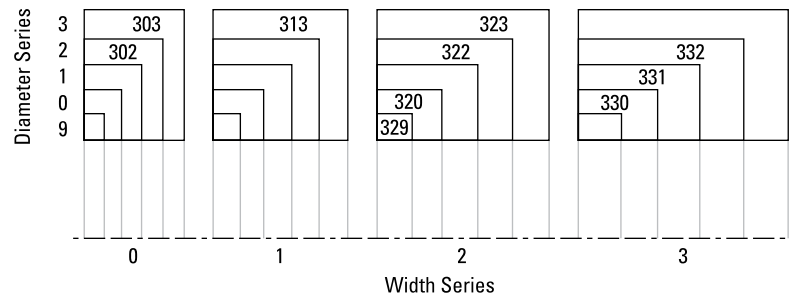


**ORIGINAL METRIC (ISO) PART-NUMBERING SYSTEM**



**Fig. 30. Original ISO part-numbering system nomenclature.**

The original metric part-numbering system for tapered roller bearings was based on the ISO 15 dimensional plan for radial bearings. A five-digit part number commencing with numeral 3 describes the bearing assembly (inner rings and outer rings).



**Fig. 31. Original ISO part-numbering system.**

**Section 1 - Symbol for bearing type**

3 always applies to tapered roller bearings.

**Section 2 - Width series**

The bearing width is classified as 9 and 0 through 3 in increasing order of width.

**Section 3 - Diameter series**

The bearing section height is classified as 9 and 0 through 3 in increasing order of O.D. for a given bore size.

**Section 4 - Inner-ring bore designation**

The last two digits multiplied by five yield the inner-ring bore diameter in millimeters.

There are two exceptions to this rule:

1. Small bearings where: 02 = 15 mm, 03 = 17 mm
2. Where the last two digits are preceded by a forward slash (/), the last two digits show the actual bore size in millimeters. Examples:

- 32218 = 90 mm bore
- 30203 = 17 mm bore
- 329/28 = 28 mm bore

### ISO 355 PART NUMBERING

As dimensions given by the ISO 15 general plan were not found to be optimal for tapered roller bearings, ISO introduced a new numbering system for tapered roller bearings in ISO 355. The numbering system of ISO 355 uses three alphanumeric fields to define a dimension series. The bearing part number is

then defined by adding the inner-ring diameter in mm after the dimension series. Although the original metric part numbers were assigned a new designation in the ISO 355 plan, the original part number is still used.

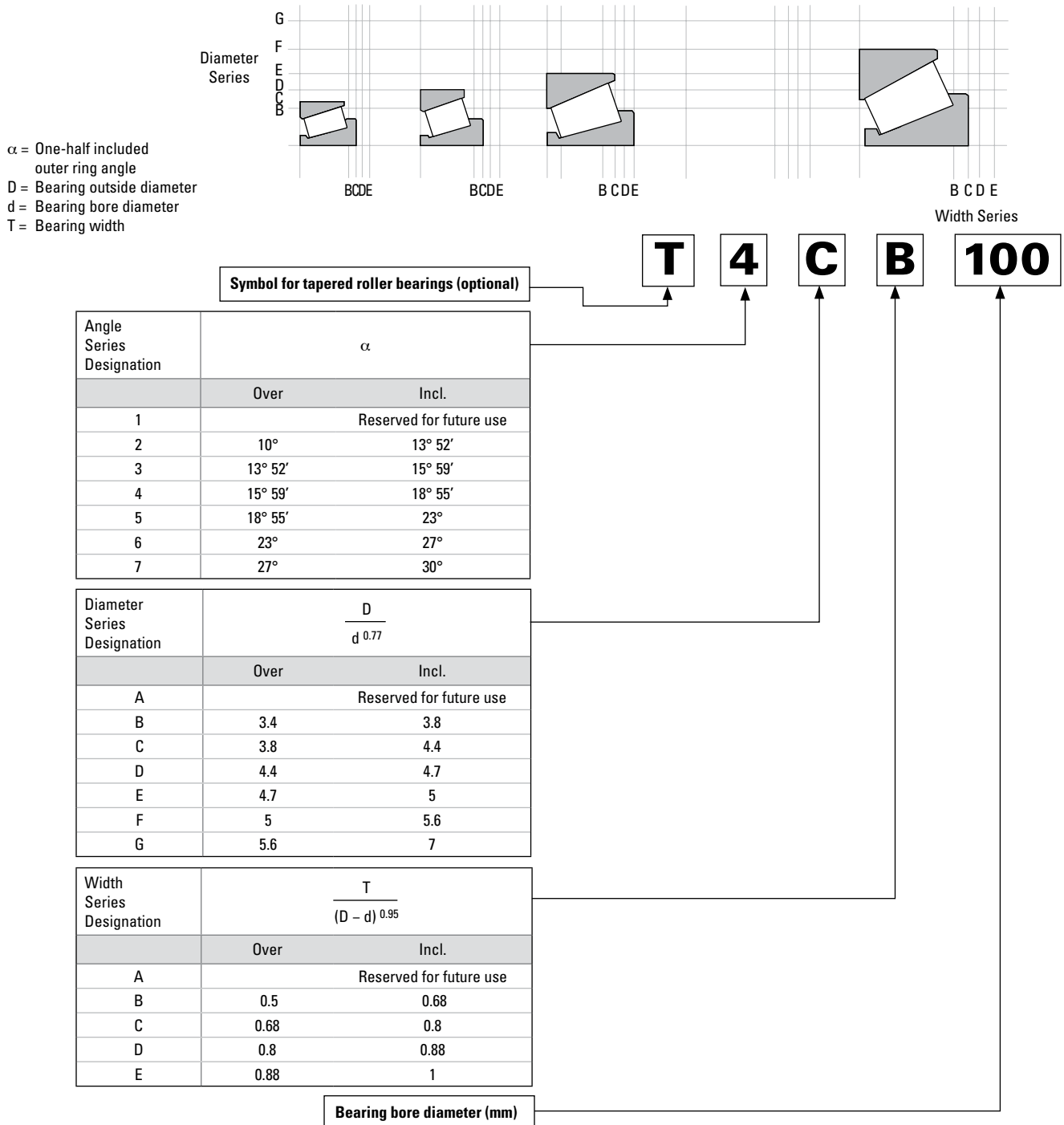


Fig. 32. ISO 355 part-numbering system.

### BEARING ASSEMBLY NUMBERS

The nomenclature for a bearing assembly consists of the inner-ring part number followed by a five-digit alphanumeric code, e.g. LM48548-902A7. The assembly nomenclature describes the bill of material of the assembly.

An assembly number is assigned on receipt of the first order for new applications. It is very important for correct function of the bearing in a given application that the same assembly number is quoted for all subsequent orders. A Timken engineer should be consulted if additional information is required on the assembly number.

### HISTORICAL PART-NUMBERING SYSTEMS

This historical nomenclature is for reference purposes only. Contact your Timken engineer with questions or for more information.

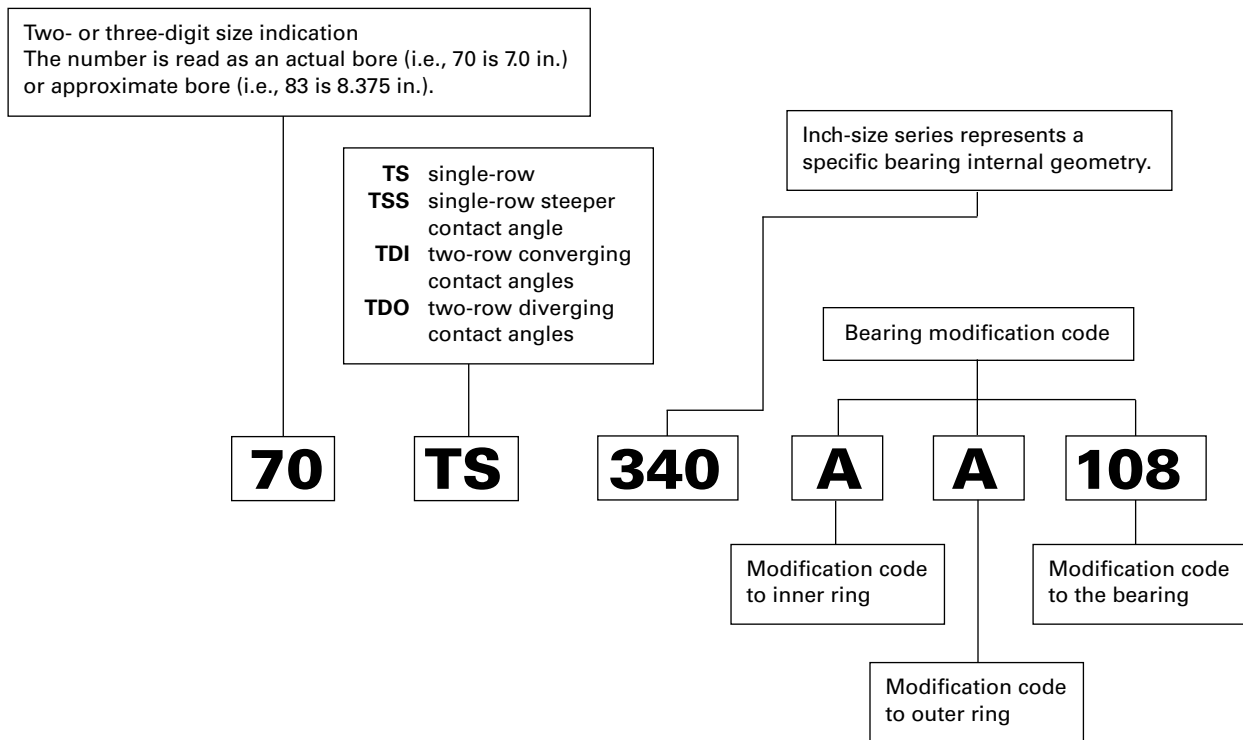


Fig. 33. Historical radial tapered roller bearing nomenclature.

For further explanation of prefix and suffix symbols or proprietary part numbers of special bearings, consult your Timken engineer.

### PREFIXES AND SUFFIXES

The following are some of the symbols used by The Timken Company and prefixes and suffixes that are part of the ABMA part numbering standard:

**TABLE 49. PREFIXES AND SUFFIXES**

Prefix	Suffix	Inner Ring or Outer Ring	Explanation
A		Inner ring & outer ring	Standard basic series part number.
	A	Inner ring	Different radius from basic part number.
	A	Inner ring	Different bore from basic part number.
	A	Inner ring	Different complement of rollers.
	A	Outer ring	Different O.D. from basic part number.
	A	Outer ring	Different radius from basic part number.
	A	Outer ring	Different width from basic part number.
	AA	Inner ring & outer ring	Different bore, O.D., width or radius from basic part number.
	AB	Inner ring	Different bore, width or radius from basic part number, assembled with brass cage.
	AB	Outer ring	Flanged outer ring. Non-interchangeable with basic part number.
	AC	Inner ring	Different bore or radius, different internal geometry.
	AC	Outer ring	Different O.D., width or radius from basic part number.
	AD	Outer ring	Double outer ring. Non-interchangeable with basic part number.
	ADW	Inner ring	Double inner ring. Pilots and slots each end, holes in large rib.
	AH	Inner ring	Assembled with special cage, rollers, and/or internal geometry.
	AL	Inner ring	Assembled with DUO-FACE seal.
	ARB	Outer ring	Single outer ring with snap ring groove in O.D.
	AS	Inner ring & outer ring	Different bore, O.D., width, or radius from basic part number.
	ASB	Inner ring	Single inner ring, different bore or width from basic part number, assembled with brass cage.
	AV	Inner ring & outer ring	Made of special steel.
	AW	Inner ring & outer ring	Keyway or slotted inner ring or outer ring.
	AX	Inner ring & outer ring	Different bore, O.D., width, or radius from basic part number.
	AXB	Inner ring	Different bore, width, or radius from basic part number, assembled with brass cage.
	AXD	Outer ring	ISO outer ring - double outer ring without oil holes or groove.
	AXV	Inner ring & outer ring	Different O.D., width, or radius from basic part number. Made of special steel.
	AXX	Inner ring & outer ring	Different O.D., width, or radius from basic part number. Made of special steel.
	B	Outer ring	Flanged outer ring. Non-interchangeable with basic part number.
	B	Inner ring	Inner ring using brass cage.
	B	Inner ring & outer ring	ISO bearing with same boundary dimensions as basic part number, but with different internal geometry, steeper included outer-ring angle.
	BA	Outer ring	Flanged outer ring. Non-interchangeable with basic part number.
	BNA	Inner ring	ISO inner ring used in assemblies with two inner rings mated with double outer ring to form a double-row, non-adjusting bearing. Non-interchangeable with other inner rings having the same basic part numbers, which may vary in bore or width dimensions.
	BR	Outer ring	Single outer ring with groove in O.D. for snap ring.
	BS	Outer ring	Flanged outer ring. Non-interchangeable with basic part number.
	BW	Outer ring	Flanged outer ring with slot. Non-interchangeable with basic part number.
	BX	Outer ring	Flanged outer ring. Non-interchangeable with basic part number.
	BXX	Outer ring	Flanged single outer ring. Made of special steel.
	C	Inner ring	Single inner ring, envelope dimensions same as basic part number, different internal geometry.
	C	Outer ring	Dimensionally different from basic part number. Non-interchangeable.
	CA	Inner ring	Single inner ring, envelope dimensions same as basic part number, different internal geometry.
	CB	Inner ring	Single inner ring, dimensionally different from basic part number.
	CD	Outer ring	Double outer ring with oil holes and groove. One hole counterbored for locking pin.
	CE	Outer ring	Dimensionally different from basic part number. Non-interchangeable.
CN		Outer ring	Neoprene-cushioned outer ring.

Prefix	Suffix	Inner Ring or Outer Ring	Explanation
	CP	Inner ring & outer ring	Flash-chrome plated. Otherwise, interchangeable with basic part number.
	CP	Inner ring & outer ring	Envelope dimensions same as basic part number, different internal geometry, customized for performance.
	CR	Inner ring & outer ring	Ribbed outer-ring bearing series.
	CS	Inner ring & outer ring	Dimensionally different from basic part number. Non-interchangeable.
	CX	Inner ring	Dimensionally different from basic part number. Non-interchangeable.
	D	Inner ring & outer ring	Double inner ring or double outer ring. Non-interchangeable with basic part number.
	DA	Inner ring	Double inner ring. Non-interchangeable with inner rings having same basic part number.
	DA	Outer ring	Spherical O.D. double outer ring. Non-interchangeable with basic part number or other double outer rings having same basic numbers.
	DB	Outer ring	Double outer ring with flange. Non-interchangeable with basic part number or double outer rings having same basic numbers.
	DB	Inner ring	Double inner ring assembled with brass cages.
	DD	Inner ring & outer ring	Special long double inner ring or outer ring. Non-interchangeable with basic part number or other double parts having same basic numbers.
	DE	Inner ring & outer ring	Double inner ring or double outer ring having different dimensions or other characteristics from single and double parts identified with same basic part number.
	DF	Outer ring	Double outer ring with oil holes and groove. Snap ring groove on O.D.
	DG	Inner ring	Double inner ring with pressure-removal groove or helical groove in bore.
	DGA	Inner ring	Double inner ring with pressure-removal groove or helical groove in bore. Non-interchangeable with basic part number.
	DGE	Inner ring	Double inner ring with pressure-removal groove or helical groove in bore. Non-interchangeable with basic part number.
	DGH	Inner ring	Double inner ring with pressure-removal groove or helical groove in bore and with special cage, rollers, and/or internal geometry.
	DGW	Inner ring	Double inner ring with pressure-removal groove or helical groove in bore, and having face slots.
	DH	Inner ring	Double inner ring with special cage, rollers, and/or internal geometry.
	DP	Inner ring	Double inner ring with puller groove.
	DR	Outer ring	Double outer ring for ribbed outer-ring series. Non-interchangeable with single and double outer rings identified with same basic part number.
	DRB	Outer ring	Double outer ring with snap-ring groove.
	DS	Outer ring	Crowned O.D. double outer ring. Non-interchangeable with other outer rings having same basic part numbers.
	DT	Outer ring	Tapered O.D. double outer ring. Non-interchangeable with other outer rings having same basic part numbers.
	DV	Inner ring & outer ring	Double inner ring or double outer ring made of special steel.
	DVH	Inner ring	Double inner ring, special steel, and/or internal geometry.
	DW	Inner ring & outer ring	Double inner ring or double outer ring with keyway or slot. Non-interchangeable with inner rings or outer rings identified with same basic part numbers.
	DWA	Inner ring	Double inner ring with one end extended and with oil slots in extended end (asymmetrical).
	DWH	Inner ring	Double inner ring with oil slots, assembled with special cage, rollers, and/or internal geometry.
	DWV	Inner ring & outer ring	Double inner ring or double outer ring with keyway or slot. Non-interchangeable with inner rings or outer rings identified with same basic part numbers. Made of special steel.
DX		Inner ring & outer ring	DuraSpexx power rating series.
	DX	Outer ring	Adaptor for spherical or straight O.D. outer ring.
	DX	Outer ring	Threaded O.D. double outer ring. Non-interchangeable with outer rings identified with same basic part numbers.
	DXX	Inner ring & outer ring	Double inner ring or double outer ring made of special steel.
	E	Inner ring & outer ring	Inner rings or outer rings having special characteristics differing from and non-interchangeable with other inner rings or outer rings identified with the same basic part numbers.
	ED	Outer ring	Double outer rings. Non-interchangeable with other outer rings identified with same basic part numbers.
	EDC	Outer ring	Double outer rings, special hole in O.D. for locking pin.
EE		Inner ring	Large and small ribs - close-guided rollers. Non-interchangeable with other inner rings identified with same basic part numbers.
EH		Inner ring & outer ring	Extra-heavy series.

# TAPERED ROLLER BEARINGS

## PART-NUMBERING SYSTEMS

Prefix	Suffix	Inner Ring or Outer Ring	Explanation
EL		Inner ring & outer ring	Extra light series.
EX		Inner ring & outer ring	Experimental.
	EXX	Inner ring & outer ring	Inner rings or outer rings having special characteristics differing from and non-interchangeable with other inner rings or outer rings identified with the same basic part numbers. Made of special steel.
	F	Inner ring	Assembled with polymer cage.
FL		Inner ring & outer ring	Free lateral series, no large or small ribs.
FX		Inner ring & outer ring	Factory identification number only.
	G	Inner ring	Cage groove in bore.
H		Inner ring & outer ring	Heavy series. Non-interchangeable with other inner rings and outer rings identified with same basic part numbers.
	H	Inner ring	Assembled with special cage, rollers, and/or internal geometry.
	HV	Inner ring	Assembled with special cage, rollers, and/or internal geometry. Made of special steel.
HH		Inner ring & outer ring	Heavy-heavy series. Non-interchangeable with other inner rings and outer rings identified with same basic part numbers.
HM		Inner ring & outer ring	Heavy-medium series. Non-interchangeable with other inner rings or outer rings identified with same basic part numbers.
	HP	Inner ring	Assembled with special cage and/or roller, different internal geometry. Customized for performance.
	HR	Outer ring	Special outer ring used in Hydra-Rib bearing.
J		Inner ring & outer ring	Used alone or with other prefix letters to indicate metric bore and/or O.D.
JC		Inner ring & outer ring	Metric series.
JD		Inner ring & outer ring	Metric series.
JE		Inner ring & outer ring	Metric series.
JF		Inner ring & outer ring	Metric series.
JG		Inner ring & outer ring	Metric series.
JN		Inner ring & outer ring	Metric series.
JP		Inner ring & outer ring	Metric series.
JR		Inner ring & outer ring	Metric series.
JRM		Inner ring & outer ring	Metric series, UNIPAC bearing.
JS		Inner ring & outer ring	Metric series.
JT		Inner ring & outer ring	Metric series.
JU		Inner ring & outer ring	Metric series.
JW		Inner ring & outer ring	Metric series.
K		Outer ring	Double outer ring with heavy section. May have unusual features such as flange, tapered O.D., etc.
K		Inner ring & outer ring	Through-hardened components, non-DIN 720 part numbers.
K		Miscellaneous	K prefix with five or six digits following also used for miscellaneous components (seals, bolts, filler rings, etc.).
	KP	Thrust bearing	Cadmium plated.
L		Inner ring & outer ring	Light series. Non-interchangeable with other inner rings and outer rings identified with same basic part numbers.
	L	Inner ring	Inner ring assembled with DUO-FACE seal.
	L	Outer ring	Loose rib. Part of unit-bearing.
	LA	Inner ring	Inner ring assembled with DUO-FACE-PLUS seal.
	LA, LB, LC, etc.	Seal	These suffixes are used on a basic DUO-FACE-PLUS seal number to identify the assembly resulting from the use of the seal with various inner rings in the series.
LL		Inner ring & outer ring	Light-light series.
LM		Inner ring & outer ring	Light-medium series.
M		Inner ring & outer ring	Medium series.
	M	Inner ring & outer ring	Through-hardened components, DIN 720 part numbers, IsoClass part numbers.
N		Inner ring	Bock- or Gilliam-type bearings.
NA	NA	Inner ring	Two inner rings mated with double outer ring to form double-row non-adjustable bearing. Non-interchangeable with other inner rings having same basic part numbers which may vary in bore, O.D., and width dimensions.
	NA	Outer ring	Etched electric pencil on double outer rings mated with two NA-type single inner rings to form double-row non-adjustable bearings.

Prefix	Suffix	Inner Ring or Outer Ring	Explanation
	NAV	Inner ring	NA inner ring made of special steel.
	NC	Outer ring	Cushioned outer ring (usually neoprene.)
	NI	Inner ring	Tapered or threaded bore.
NP		Inner ring & outer ring	Used with random numbers for product differentiation.
	NR	Inner ring	NA-type ribless inner ring for ribbed outer-ring series.
	NW	Inner ring	NA-type inner ring with slotted front face.
	NWV	Inner ring	NA-type inner ring with slotted front face. Made of special steel.
	NX	Inner ring	Lapped front face.
	P	Inner ring	Puller groove.
	P	Inner ring & outer ring	Customized for performance.
R		Inner ring & outer ring	Gilliam replacement series. Non-interchangeable with other inner rings and outer rings identified with same basic numbers.
	R	Inner ring & outer ring	Special feature bearing. Non-interchangeable with bearings having the same basic part numbers.
	R	Inner ring & outer ring	Bock-type bearing.
	R	Inner ring	Basic part number with polymer lubricant.
	RB	Outer ring	Snap ring on O.D.
RC		Inner ring & outer ring	Special ribbed outer-ring bearing.
	RN	Various	Used with random numbers, not to exceed six digits, for purchased items that are distributed by Timken.
	RR	Inner ring & outer ring	Relieved ring.
	S	Inner ring & outer ring	Special feature bearing. Non-interchangeable with bearings having same basic part numbers.
	SA	Inner ring & outer ring	Special feature bearing. Non-interchangeable with bearings having same basic part numbers.
	SB	Inner ring	Assembled with brass cage.
	SB	Outer ring	Flanged outer ring.
	SC	Inner ring	With square bore.
	SD	Inner ring & outer ring	Double inner ring with square bore or double outer ring.
	SH	Inner ring	Special feature bearing, with special cage, rollers, and/or internal geometry. Non-interchangeable with bearings having same basic part numbers.
	SL	Thrust bearing	Basic part number with polymer lubricant.
	SR	Inner ring	Different radius from basic part numbers.
	SW	Inner ring & outer ring	Slot or keyway. Non-interchangeable with bearings having same basic part numbers.
	SWB	Inner ring	Slot or keyway assembled with brass cage. Non-interchangeable with bearings having same basic part numbers.
	SWV	Inner ring	Slot or keyway made of special steel. Non-interchangeable with bearings having same basic part numbers.
	SX	Outer ring	Special feature bearing. Non-interchangeable with bearings having same basic part numbers.
T		Rings	Thrust bearing assemblies.
T		Outer rings	Double outer ring with heavy section. May have unusual feature such as flange, tapered O.D., etc.
	T	Inner ring	Tapered bore.
	T	Outer ring	Tapered O.D.
	TA	Inner ring	Tapered bore NA-type inner ring.
	TA	Outer ring	Tapered O.D.
	TB	Inner ring	Tapered-bore inner ring with brass cage.
TC		Rings	Thrust bearing assemblies.
	TC	Inner rings	Tapered bore.
	TD	Inner ring	Double with tapered bore.
	TDB	Inner ring	Double with tapered bore, assembled with brass cages.
	TDE	Inner ring	Double with tapered bore and extended rib.
	TDG	Inner ring	Double with tapered bore, pressure-removal groove or spiral groove in bore.
	TDGV	Inner ring	Double with tapered bore, pressure-removal groove or spiral groove in bore. Made of special steel.
	TDH	Inner ring	Double with tapered bore, special cage, rollers or internal geometry.
	TDL	Inner ring	Double with tapered bore, interlock feature.
	TDV	Inner ring	Double with tapered bore. Made of special steel.

# TAPERED ROLLER BEARINGS

## PART-NUMBERING SYSTEMS

Prefix	Suffix	Inner Ring or Outer Ring	Explanation
	TDW	Inner ring	Double with tapered bore and slots or keys.
	TDXX	Inner ring	Double with tapered bore. Made of special steel.
	TE	Inner ring	Single, tapered bore, extended large rib.
	TEV	Inner ring	Single, tapered bore, extended large rib. Made of special steel.
	TL	Inner ring	Tapered-bore with interlock feature.
	TLE	Inner ring	Tapered-bore with interlock feature and extended rib.
	TP	Inner ring	Tapered-bore inner ring with puller groove.
	TPE	Inner ring	Tapered-bore inner ring with puller groove, extended inner-ring large rib.
	TV	Inner ring & outer ring	Tapered-bore inner ring or outer ring O.D. Made of special steel.
	TW	Inner ring & outer ring	Tapered-bore inner ring or outer ring O.D. with slots or keys.
	TWE	Inner ring & outer ring	Tapered-bore inner ring or outer ring O.D. with locking keyway in front face, extended inner ring large rib or outer ring width.
	TXX	Inner ring	Tapered bore. Made of special steel.
U		Inner ring & outer ring	Basic series part number, unitized, self-contained.
	U	Inner ring & outer ring	Basic series part number, unitized, self-contained.
	US	Inner ring & outer ring	Special close stand.
V		Inner ring & outer ring	Special close stand.
	V	Inner ring & outer ring	Made of special steel.
	VC	Inner ring	Special internal geometry. Made of special steel.
	VH	Inner ring	Special cage, rollers, and/or internal geometry. Made of special steel.
	W	Inner ring & outer ring	Slot(s) or keyway(s).
	W	Thrust bearing	Oil holes in retainer.
	WA	Inner ring & outer ring	Slot(s) or keyway(s).
	WB	Inner ring	Slot(s) or keyway(s) with brass cage.
	WC	Inner ring & outer ring	Slot(s) or keyway(s).
	WD	Inner ring & outer ring	Double inner ring or outer ring with slot(s) or keyway(s).
	WE	Inner ring & outer ring	Extended face with slot(s) or keyway(s).
	WS	Inner ring & outer ring	Slot(s) or keyway(s).
WV		Inner ring & outer ring	Slot(s) or keyway(s). Made of special steel.
	WXX	Inner ring & outer ring	Slot(s) or keyway(s). Made of special steel.
X		Inner ring	ISO part number.
	X	Inner ring	Slot(s) or keyway(s).
	X	Inner ring & outer ring	Special feature bearing. Non-interchangeable with bearings having the same basic part number.
	X	Inner ring & outer ring	ISO bearing with same boundary dimensions as basic part number but with different internal geometry, yielding increased rating.
	XA	Inner ring & outer ring	Special feature bearing. Non-interchangeable with bearings having the same basic part number.
XAA		Inner ring	ISO single inner ring. Non-interchangeable with bearings having the same basic part number.
XAB		Inner ring	ISO single inner ring. Non-interchangeable with bearings having the same basic part number.
	XB	Inner ring	Different bore, width, or radius, from basic part number. Assembled with brass cage.
	XB	Outer ring	Special feature flanged outer ring. Non-interchangeable with bearings having the same basic part number.
XC		Inner ring & outer ring	Limited production bearings to which standard series part numbers have not been assigned.
	XD	Outer ring	Double outer ring, no oil holes or groove.
	XD	Inner ring	Double inner ring, different bore or width from basic part numbers.
	XD	Inner ring	Double inner ring, oil holes in large rib.
	DXP	Outer ring	Double outer ring, no oil holes or groove, special material and process.
	XE	Outer ring	Different bore, width, or radius from basic part number.
XGA		Inner ring	ISO single inner ring. Non-interchangeable with bearings having the same basic part number.
XGB		Inner ring	ISO single inner ring. Non-interchangeable with bearings having the same basic part number.
	XP	Inner ring	Special steel and process.
XR		Inner ring & outer ring	Crossed roller bearings.
	XS	Inner ring & outer ring	Different bore, O.D., width, or radius from basic part number.

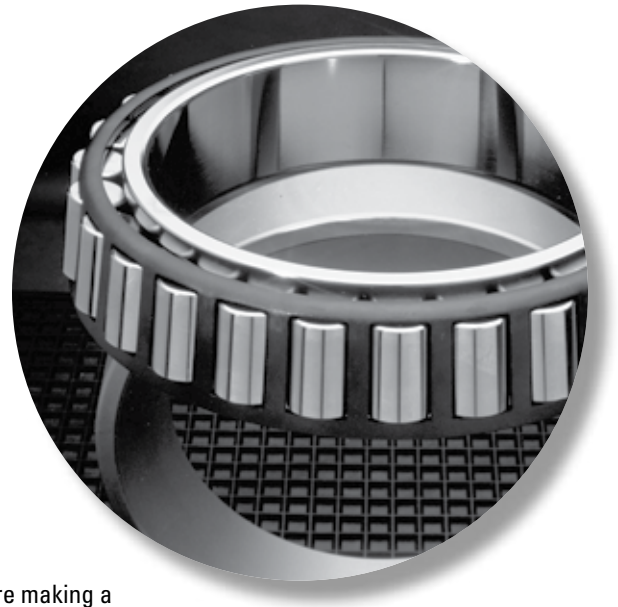


Prefix	Suffix	Inner Ring or Outer Ring	Explanation
	XV	Inner ring & outer ring	Special feature inner ring or outer ring made of special steel.
	XW	Inner ring	Slotted.
	XX	Inner ring & outer ring	Single inner ring or single outer ring. Made of special steel.
Y		Outer ring	ISO part number.
	YD	Outer ring	Double outer ring with oil holes, no groove.
	YDA	Outer ring	Double outer ring with oil holes, no groove. Non-interchangeable with bearings having the same basic part number.
	YDV	Outer ring	Double outer ring with oil holes, no groove. Made of special steel.
	YDW	Inner ring	Double outer ring with oil holes, no groove. Slots or keyways in faces.
YKA		Outer ring	ISO single outer ring. Non-interchangeable with bearings having the same basic part number.
YKB		Outer ring	ISO single outer ring. Non-interchangeable with bearings having the same basic part number.
YSA		Outer ring	ISO single outer ring. Non-interchangeable with bearings having the same basic part number.
	Z	Inner ring & outer ring	Close stand part.



## ***TYPE TS***

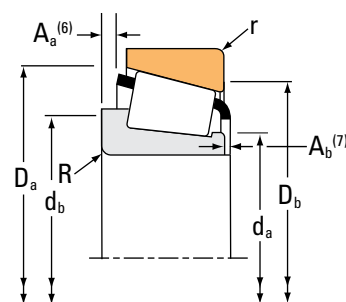
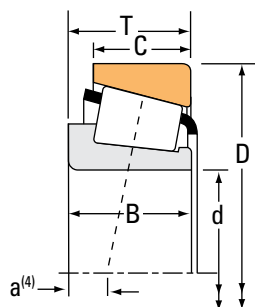
- TS style is the most widely used tapered roller bearing.
- Part numbers give the widest possible choice from the comprehensive range of metric and inch sizes available from The Timken Company. See page 393 for metric (ISO series and J-prefix) part numbers.
- Consult your Timken engineer before making a final bearing selection to help ensure suitability, availability and the most cost-effective solution.



# TAPERED ROLLER BEARINGS

## SINGLE-ROW • TYPE TS

### TYPE TS



Bearing Dimensions			Load Ratings						Part Number				
Bore d	O.D. D	Width T	Dynamic <sup>(1)</sup>		Factors <sup>(2)</sup>		Dynamic <sup>(3)</sup>		Factors <sup>(2)</sup>		Static C <sub>0</sub>	Inner	Outer
			C <sub>1</sub>	e	Y	C <sub>90</sub>	C <sub>a90</sub>	K	N	N			
mm in.	mm in.	mm in.	N lbf			N lbf	N lbf		N lbf				
7.937 0.3125	31.991 1.2595	10.008 0.3940	10800 2430	0.41	1.48	2800 630	1940 437	1.44	9230 2070		A2031	A2126	
9.525 0.3750	31.991 1.2595	10.008 0.3940	10800 2430	0.41	1.48	2800 630	1940 437	1.44	9230 2070		A2037	A2126	
11.112 0.4375	34.988 1.3775	10.998 0.4330	13200 2960	0.45	1.32	3410 767	2640 594	1.29	11500 2580		A4044	A4138	
11.987 0.4719	31.991 1.2595	10.008 0.3940	10800 2430	0.41	1.48	2800 630	1940 437	1.44	9230 2070		A2047	A2126	
12.680 0.4992	34.988 1.3775	10.998 0.4330	13200 2960	0.45	1.32	3410 767	2640 594	1.29	11500 2580		A4049	A4138	
12.700 0.5000	34.988 1.3775	10.998 0.4330	13200 2960	0.45	1.32	3410 767	2640 594	1.29	11500 2580		A4050	A4138	
12.700 0.5000	38.100 1.5000	13.495 0.5313	20900 4690	0.28	2.18	5410 1220	2550 574	2.12	17100 3840		00050	00150	
14.989 0.5901	34.988 1.3775	10.998 0.4330	13200 2960	0.45	1.32	3410 767	2640 594	1.29	11500 2580		A4059	A4138	
15.875 0.6250	34.988 1.3775	10.998 0.4330	14300 3230	0.32	1.88	3720 836	2030 456	1.83	13900 3130		L21549	L21511	
15.875 0.6250	39.992 1.5745	12.014 0.4730	13400 3020	0.53	1.14	3480 782	3140 705	1.11	12300 2770		A6062	A6157	
15.875 0.6250	41.275 1.6250	14.288 0.5625	24000 5400	0.31	1.93	6230 1400	3310 745	1.88	21300 4780		03062	03162	
15.875 0.6250	42.862 1.6875	14.288 0.5625	18800 4230	0.70	0.85	4870 1100	5860 1320	0.83	17400 3920		11590	11520	
15.875 0.6250	42.862 1.6875	16.670 0.6563	31400 7070	0.33	1.81	8150 1830	4620 1040	1.76	29200 6560		17580	17520	
15.875 0.6250	47.000 1.8504	14.381 0.5662	26700 6010	0.36	1.68	6930 1560	4230 952	1.64	25400 5720		05062	05185	
15.875 0.6250	49.225 1.9380	19.845 0.7813	42800 9630	0.27	2.26	11100 2500	5050 1140	2.20	40500 9100		09062	09195	
15.875 0.6250	49.225 1.9380	23.020 0.9063	42800 9630	0.27	2.26	11100 2500	5050 1140	2.20	40500 9100		09062	09194	
15.875 0.6250	53.975 2.1250	22.225 0.8750	55100 12400	0.59	1.02	14300 3210	14400 3250	0.99	42500 9560		21063	21212	

<sup>(1)</sup>Based on 1 x 10<sup>6</sup> revolutions L<sub>10</sub> life, for the ISO life-calculation method.

<sup>(2)</sup>Consult your Timken engineer for instructions on use or review the Timken Engineering Manual on timken.com/catalogs.

<sup>(3)</sup>Based on 90 x 10<sup>6</sup> revolutions L<sub>10</sub> life, for The Timken Company life-calculation method. C<sub>90</sub> and C<sub>a90</sub> are radial and thrust values.

Bearing Dimensions											Geometry Factors			Bearing Weight
Width B	Width C	Eff. Ctr. a <sup>(4)</sup>	Shaft			Housing			Cage		G <sub>1</sub>	G <sub>2</sub>	C <sub>g</sub>	
			Max Shaft Fillet Radius R <sup>(5)</sup>	Backing Shoulder Dia. d <sub>a</sub>	Backing Shoulder Dia. d <sub>b</sub>	Max Housing Fillet Radius r <sup>(5)</sup>	Backing Shoulder Dia. D <sub>a</sub>	Backing Shoulder Dia. D <sub>b</sub>	A <sub>a</sub> <sup>(6)</sup>	A <sub>b</sub> <sup>(7)</sup>				
mm in.	mm in.	mm in.	mm in.	mm in.	mm in.	mm in.	mm in.	mm in.	mm in.	mm in.				kg lbs.
10.785 0.4246	7.938 0.3125	-3.0 -0.12	0.5 0.02	12.5 0.49	13.0 0.51	1.3 0.05	29.0 1.14	26.0 1.02	-0.3 -0.01	1.5 0.06	1.7	3.2	0.0308	0.05 0.10
10.785 0.4246	7.938 0.3125	-3.0 -0.12	1.3 0.05	13.5 0.53	15.0 0.59	1.3 0.05	29.0 1.14	26.0 1.02	-0.3 -0.01	1.5 0.06	1.7	3.2	0.0308	0.05 0.10
10.988 0.4326	8.730 0.3437	-2.5 -0.10	1.3 0.05	15.5 0.61	17.5 0.69	1.3 0.05	32.0 1.26	29.0 1.14	0.1 0.00	1.2 0.05	2.3	4.1	0.0355	0.05 0.13
10.785 0.4246	7.938 0.3125	-3.0 -0.12	0.8 0.03	15.5 0.61	16.5 0.65	1.3 0.05	29.0 1.14	26.0 1.02	-0.3 -0.01	1.5 0.06	1.7	3.2	0.0308	0.04 0.09
10.988 0.4326	8.730 0.3437	-2.5 -0.10	0.8 0.03	17.5 0.69	17.5 0.69	1.3 0.05	32.0 1.26	29.0 1.14	0.1 0.00	1.2 0.05	2.3	4.1	0.0355	0.05 0.12
10.988 0.4326	8.730 0.3437	-2.5 -0.10	1.3 0.05	17.0 0.67	18.5 0.73	1.3 0.05	32.0 1.26	29.0 1.14	0.1 0.00	1.2 0.05	2.3	4.1	0.0355	0.05 0.12
14.072 0.5540	11.112 0.4375	-5.1 -0.20	1.5 0.06	16.5 0.65	19.0 0.75	0.8 0.03	34.0 1.34	33.0 1.30	-0.4 -0.02	1.3 0.06	3.1	2.9	0.0329	0.08 0.18
10.988 0.4326	8.730 0.3437	-2.5 -0.10	0.8 0.03	19.0 0.75	19.5 0.77	1.3 0.05	32.0 1.26	29.0 1.14	0.1 0.00	1.2 0.05	2.3	4.1	0.0355	0.04 0.11
10.998 0.4330	8.712 0.3430	-3.3 -0.13	1.3 0.05	19.5 0.77	21.5 0.85	1.3 0.05	32.5 1.28	29.0 1.14	-0.3 -0.02	1.4 0.06	3.0	5.4	0.0348	0.06 0.11
11.153 0.4391	9.525 0.3750	-1.5 -0.06	1.3 0.05	20.5 0.81	22.0 0.87	1.3 0.05	37.0 1.46	34.0 1.34	0.5 0.02	1.6 0.07	2.9	5.6	0.0404	0.08 0.16
14.681 0.5780	11.112 0.4375	-5.1 -0.20	1.3 0.05	20.0 0.79	21.5 0.85	2.0 0.08	37.5 1.48	34.0 1.34	0.3 0.01	1.4 0.06	4.2	4.0	0.0384	0.09 0.21
14.288 0.5625	9.525 0.3750	-1.3 -0.05	1.5 0.06	22.5 0.89	24.5 0.96	1.5 0.06	39.5 1.56	34.5 1.36	1.5 0.05	0.7 0.03	3.4	4.6	0.0465	0.10 0.22
16.670 0.6563	13.495 0.5313	-5.8 -0.23	1.5 0.06	21.0 0.83	23.0 0.91	1.5 0.06	39.0 1.54	36.5 1.44	0.4 0.01	1.9 0.08	5.3	4.5	0.0423	0.12 0.27
14.381 0.5662	11.112 0.4375	-4.1 -0.16	1.5 0.06	21.0 0.83	23.5 0.93	1.3 0.05	42.5 1.67	40.5 1.59	0.2 0.00	1.3 0.05	5.8	5.5	0.0448	0.14 0.29
21.539 0.8480	14.288 0.5625	-9.1 -0.36	0.8 0.03	21.5 0.85	22.0 0.87	1.3 0.05	44.5 1.75	42.0 1.65	2.2 0.09	0.7 0.03	8.0	4.0	0.0452	0.19 0.44
21.539 0.8480	17.462 0.6875	-9.1 -0.36	0.8 0.03	21.5 0.85	22.0 0.87	3.5 0.14	44.5 1.75	39.0 1.54	2.2 0.09	0.7 0.03	8.0	4.0	0.0452	0.21 0.47
21.839 0.8598	15.875 0.6250	-5.8 -0.23	0.8 0.03	26.4 1.03	29.0 1.14	2.3 0.09	50.0 1.97	43.0 1.69	1.3 0.05	2.0 0.08	7.0	4.1	0.0558	0.25 0.57

<sup>(4)</sup>Negative value indicates effective center inside cone (inner-ring) backface.

<sup>(5)</sup>These maximum fillet radii will be cleared by the bearing corners.

<sup>(6)</sup>Negative value indicates cage extends beyond cone (inner-ring) backface.

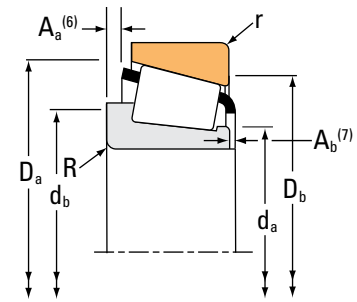
<sup>(7)</sup>Negative value indicates cage that does not extend beyond cone (inner-ring) front face.

Continued on next page.

# TAPERED ROLLER BEARINGS

## SINGLE-ROW • TYPE TS

### TYPE TS



Bearing Dimensions			Load Ratings						Part Number				
Bore d	O.D. D	Width T	Dynamic <sup>(1)</sup>		Factors <sup>(2)</sup>		Dynamic <sup>(3)</sup>		Factors <sup>(2)</sup>		Static C <sub>0</sub>	Inner	Outer
			C <sub>1</sub>	e	Y	C <sub>90</sub>	C <sub>a90</sub>	K	N	N			
mm in.	mm in.	mm in.	N lbf			N lbf	N lbf		N lbf				
15.987 0.6294	46.975 1.8494	21.000 0.8268	40100 9020	0.55	1.10	10400 2340	9720 2190	1.07	39300 8840		HM81649	HM81610	
16.993 0.6690	39.982 1.5741	12.014 0.4730	13400 3020	0.53	1.14	3480 782	3140 705	1.11	12300 2770		A6067	A6157A	
16.993 0.6690	39.992 1.5745	12.014 0.4730	13400 3020	0.53	1.14	3480 782	3140 705	1.11	12300 2770		A6067	A6157	
16.993 0.6690	47.000 1.8504	14.381 0.5662	26700 6010	0.36	1.68	6930 1560	4230 952	1.64	25400 5720		05066	05185	
17.455 0.6872	36.525 1.4380	11.112 0.4375	13000 2930	0.49	1.23	3380 760	2820 634	1.20	11600 2600		A5069	A5144	
17.462 0.6875	39.878 1.5700	13.843 0.5450	29400 6600	0.29	2.10	7610 1710	3730 838	2.04	23400 5260		LM11749	LM11710	
17.462 0.6875	44.450 1.7500	12.700 0.5000	20300 4550	0.48	1.25	5250 1180	4310 969	1.22	20600 4640		4C	6	
17.462 0.6875	44.450 1.7500	15.494 0.6100	26700 6010	0.36	1.68	6930 1560	4230 952	1.64	25400 5720		05068	05175	
17.987 0.7082	47.000 1.8504	14.381 0.5662	26700 6010	0.36	1.68	6930 1560	4230 952	1.64	25400 5720		05070XS	05185-S	
18.000 0.7087	47.000 1.8504	14.381 0.5662	24700 5560	0.36	1.68	6420 1440	3920 881	1.64	25400 5720		05070X	05185-S	
19.004 0.7482	56.896 2.2400	19.368 0.7625	45400 10200	0.31	1.95	11800 2650	6200 1390	1.90	45300 10200		1774	1729	
19.004 0.7482	56.896 2.2400	19.368 0.7625	45400 10200	0.31	1.95	11800 2650	6200 1390	1.90	45300 10200		1774	1729X	
19.050 0.7500	39.992 1.5745	12.014 0.4730	13400 3020	0.53	1.14	3480 782	3140 705	1.11	12300 2770		A6075	A6157	
19.050 0.7500	41.275 1.6250	11.905 0.4687	13400 3020	0.53	1.14	3480 782	3140 705	1.11	12300 2770		A6075	A6162	
19.050 0.7500	44.450 1.7500	12.700 0.5000	20300 4550	0.48	1.25	5250 1180	4310 969	1.22	20600 4640		4A	6	
19.050 0.7500	45.237 1.7810	15.494 0.6100	39100 8800	0.30	2.00	10100 2280	5220 1170	1.94	32000 7200		LM11949	LM11910	
19.050 0.7500	47.000 1.8504	14.381 0.5662	26700 6010	0.36	1.68	6930 1560	4230 952	1.64	25400 5720		05075	05185	

<sup>(1)</sup>Based on 1 x 10<sup>6</sup> revolutions L<sub>10</sub> life, for the ISO life-calculation method.

<sup>(2)</sup>Consult your Timken engineer for instructions on use or review the Timken Engineering Manual on timken.com/catalogs.

<sup>(3)</sup>Based on 90 x 10<sup>6</sup> revolutions L<sub>10</sub> life, for The Timken Company life-calculation method. C<sub>90</sub> and C<sub>a90</sub> are radial and thrust values.

Bearing Dimensions											Geometry Factors			Bearing Weight
Width B	Width C	Eff. Ctr. a <sup>(4)</sup>	Shaft			Housing			Cage		G <sub>1</sub>	G <sub>2</sub>	C <sub>g</sub>	
			Max Shaft Fillet Radius R <sup>(5)</sup>	Backing Shoulder Dia. d <sub>a</sub>	Backing Shoulder Dia. d <sub>b</sub>	Max Housing Fillet Radius r <sup>(5)</sup>	Backing Shoulder Dia. D <sub>a</sub>	Backing Shoulder Dia. D <sub>b</sub>	A <sub>a</sub> <sup>(6)</sup>	A <sub>b</sub> <sup>(7)</sup>				
mm in.	mm in.	mm in.	mm in.	mm in.	mm in.	mm in.	mm in.	mm in.	mm in.	mm in.				kg lbs.
21.000 0.8268	16.000 0.6299	-6.1 -0.24	1.0 0.04	23.0 0.90	27.5 1.08	2.0 0.08	43.0 1.69	37.5 1.48	1.4 0.05	1.4 0.06	6.1	4.6	0.0526	0.20 0.42
11.153 0.4391	9.525 0.3750	-1.5 -0.06	0.8 0.03	21.0 0.83	22.0 0.87	1.3 0.05	36.5 1.44	34.0 1.34	0.5 0.02	1.6 0.07	2.9	5.6	0.0404	0.08 0.16
11.153 0.4391	9.525 0.3750	-1.5 -0.06	0.8 0.03	21.0 0.83	22.0 0.87	1.3 0.05	37.0 1.46	34.0 1.34	0.5 0.02	1.6 0.07	2.9	5.6	0.0404	0.08 0.16
14.381 0.5662	11.112 0.4375	-4.1 -0.16	1.5 0.06	22.0 0.87	24.5 0.96	1.3 0.05	42.5 1.67	40.5 1.59	0.2 0.00	1.3 0.05	5.8	5.5	0.0448	0.14 0.28
11.112 0.4375	7.938 0.3125	-2.0 -0.08	1.5 0.06	21.5 0.84	23.5 0.93	1.5 0.06	33.5 1.32	30.0 1.18	0.0 0.00	1.4 0.06	2.5	4.6	0.0376	0.05 0.11
14.605 0.5750	10.668 0.4200	-5.1 -0.20	1.3 0.05	22.0 0.87	24.0 0.94	1.3 0.05	37.0 1.46	34.0 1.34	0.4 0.01	0.7 0.03	4.8	4.7	0.0392	0.09 0.18
11.908 0.4688	9.525 0.3750	-1.8 -0.07	1.5 0.06	22.0 0.87	24.5 0.96	1.5 0.06	41.0 1.61	38.0 1.50	0.8 0.03	1.6 0.07	4.6	2.6	0.0456	0.09 0.21
14.381 0.5662	11.430 0.4500	-4.1 -0.16	0.8 0.03	22.5 0.89	23.0 0.91	1.5 0.06	42.0 1.65	38.0 1.50	0.2 0.00	1.3 0.05	5.8	5.5	0.0448	0.12 0.25
14.381 0.5662	11.112 0.4375	-4.1 -0.16	2.0 0.08	22.5 0.89	26.0 1.02	1.5 0.06	42.5 1.67	40.5 1.59	0.2 0.00	1.3 0.05	5.8	5.5	0.0448	0.13 0.27
14.381 0.5662	11.112 0.4375	-4.1 -0.16	1.5 0.06	22.5 0.89	25.0 0.98	1.5 0.06	42.5 1.67	40.5 1.59	0.2 0.00	1.3 0.05	5.8	5.5	0.0448	0.13 0.28
19.837 0.7810	15.875 0.6250	-6.9 -0.27	1.5 0.06	25.0 0.98	27.0 1.06	1.3 0.05	51.0 2.01	49.0 1.93	* *	* *	10.6	5.4	0.0521	0.26 0.59
19.837 0.7810	15.875 0.6250	-6.9 -0.27	1.5 0.06	25.0 0.98	27.0 1.06	1.5 0.06	51.0 2.01	49.0 1.93	* *	* *	10.6	5.4	0.0521	0.26 0.59
11.153 0.4391	9.525 0.3750	-1.5 -0.06	1.0 0.04	23.0 0.91	24.0 0.94	1.3 0.05	37.0 1.46	34.0 1.34	0.5 0.02	1.6 0.07	2.9	5.6	0.0404	0.07 0.14
11.153 0.4391	8.730 0.3437	-1.5 -0.06	1.0 0.04	23.0 0.91	24.0 0.94	1.3 0.05	37.0 1.46	34.5 1.36	0.5 0.02	1.6 0.07	2.9	5.6	0.0404	0.07 0.15
11.908 0.4688	9.525 0.3750	-1.8 -0.07	1.5 0.06	23.5 0.93	25.5 1.00	1.5 0.06	41.0 1.61	38.0 1.50	0.8 0.03	1.6 0.07	4.6	2.6	0.0456	0.09 0.20
16.637 0.6550	12.065 0.4750	-5.6 -0.22	1.3 0.05	23.5 0.93	25.0 0.98	1.3 0.05	41.5 1.63	39.5 1.56	0.2 0.01	0.8 0.03	6.6	5.5	0.0441	0.12 0.28
14.381 0.5662	11.112 0.4375	-4.1 -0.16	1.3 0.05	23.5 0.93	25.0 0.98	1.3 0.05	42.5 1.67	40.5 1.59	0.2 0.00	1.3 0.05	5.8	5.5	0.0448	0.13 0.27

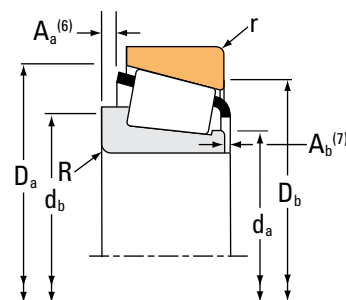
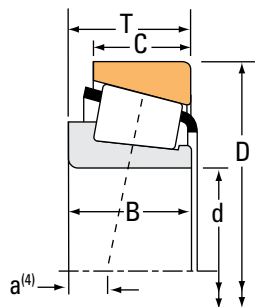
(4) Negative value indicates effective center inside cone (inner-ring) backface.  
 (5) These maximum fillet radii will be cleared by the bearing corners.  
 (6) Negative value indicates cage extends beyond cone (inner-ring) backface.  
 (7) Negative value indicates cage that does not extend beyond cone (inner-ring) front face.  
 (\*) Contact your Timken engineer for details.

Continued on next page.

# TAPERED ROLLER BEARINGS

## SINGLE-ROW • TYPE TS

### TYPE TS



Bearing Dimensions			Load Ratings						Part Number				
Bore d	O.D. D	Width T	Dynamic <sup>(1)</sup>		Factors <sup>(2)</sup>		Dynamic <sup>(3)</sup>		Factors <sup>(2)</sup>		Static C <sub>0</sub>	Inner	Outer
			C <sub>1</sub>	e	Y	C <sub>90</sub>	C <sub>a90</sub>	K	N	N			
mm in.	mm in.	mm in.	N lbf			N lbf	N lbf		N lbf				
19.050 0.7500	47.000 1.8504	14.381 0.5662	26700 6010	0.36	1.68	6930 1560	4230 952	1.64	25400 5720		05075X	05185-S	
19.050 0.7500	49.225 1.9380	18.034 0.7100	42800 9630	0.27	2.26	11100 2500	5050 1140	2.20	40500 9100		09067	09195	
19.050 0.7500	49.225 1.9380	19.845 0.7813	42800 9630	0.27	2.26	11100 2500	5050 1140	2.20	40500 9100		09078	09195	
19.050 0.7500	49.225 1.9380	19.845 0.7813	42800 9630	0.27	2.26	11100 2500	5050 1140	2.20	40500 9100		09074	09195	
19.050 0.7500	49.225 1.9380	21.209 0.8350	42800 9630	0.27	2.26	11100 2500	5050 1140	2.20	40500 9100		09067	09194	
19.050 0.7500	49.225 1.9380	21.209 0.8350	42800 9630	0.27	2.26	11100 2500	5050 1140	2.20	40500 9100		09067	09196	
19.050 0.7500	49.225 1.9380	23.020 0.9063	42800 9630	0.27	2.26	11100 2500	5050 1140	2.20	40500 9100		09074	09194	
19.050 0.7500	49.225 1.9380	23.020 0.9063	42800 9630	0.27	2.26	11100 2500	5050 1140	2.20	40500 9100		09074	09196	
19.050 0.7500	49.225 1.9380	23.020 0.9063	42800 9630	0.27	2.26	11100 2500	5050 1140	2.20	40500 9100		09078	09194	
19.050 0.7500	49.225 1.9380	23.020 0.9063	42800 9630	0.27	2.26	11100 2500	5050 1140	2.20	40500 9100		09078	09196	
19.050 0.7500	50.800 2.0000	20.637 0.8125	42800 9630	0.27	2.26	11100 2500	5050 1140	2.20	40500 9100		09074	09201	
19.050 0.7500	52.800 2.0787	18.034 0.7100	39100 8800	0.30	2.00	10100 2280	5220 1170	1.94	32000 7200		LM11949	LM11919	
19.050 0.7500	52.883 2.0820	18.430 0.7256	42800 9630	0.27	2.26	11100 2500	5050 1140	2.20	40500 9100		09067	09194-S	
19.050 0.7500	52.883 2.0820	20.241 0.7969	42800 9630	0.27	2.26	11100 2500	5050 1140	2.20	40500 9100		09074	09194-S	
19.050 0.7500	53.975 2.1250	22.225 0.8750	55100 12400	0.59	1.02	14300 3210	14400 3250	0.99	42500 9560		21075	21212	
19.050 0.7500	53.975 2.1250	22.225 0.8750	55100 12400	0.59	1.02	14300 3210	14400 3250	0.99	42500 9560		21075	21213	
19.050 0.7500	53.975 2.1250	22.225 0.8750	55100 12400	0.59	1.02	14300 3210	14400 3250	0.99	42500 9560		21075A	21212	

<sup>(1)</sup>Based on 1 x 10<sup>6</sup> revolutions L<sub>10</sub> life, for the ISO life-calculation method.

<sup>(2)</sup>Consult your Timken engineer for instructions on use or review the Timken Engineering Manual on timken.com/catalogs.

<sup>(3)</sup>Based on 90 x 10<sup>6</sup> revolutions L<sub>10</sub> life, for The Timken Company life-calculation method. C<sub>90</sub> and C<sub>a90</sub> are radial and thrust values.



Bearing Dimensions											Geometry Factors			Bearing Weight
Width B	Width C	Eff. Ctr. a <sup>(4)</sup>	Shaft			Housing			Cage		G <sub>1</sub>	G <sub>2</sub>	C <sub>g</sub>	
			Max Shaft Fillet Radius R <sup>(5)</sup>	Backing Shoulder Dia. d <sub>a</sub>	Backing Shoulder Dia. d <sub>b</sub>	Max Housing Fillet Radius r <sup>(5)</sup>	Backing Shoulder Dia. D <sub>a</sub>	Backing Shoulder Dia. D <sub>b</sub>	A <sub>a</sub> <sup>(6)</sup>	A <sub>b</sub> <sup>(7)</sup>				
mm in.	mm in.	mm in.	mm in.	mm in.	mm in.	mm in.	mm in.	mm in.	mm in.	mm in.				kg lbs.
14.381 0.5662	11.112 0.4375	-4.1 -0.16	1.5 0.06	23.5 0.93	25.4 1.00	1.5 0.06	42.5 1.67	40.5 1.59	0.2 0.00	1.3 0.05	5.8	5.5	0.0448	0.13 0.27
19.050 0.7500	14.288 0.5625	-7.4 -0.29	1.3 0.05	24.0 0.94	25.5 1.00	1.3 0.05	44.5 1.75	42.0 1.65	0.4 0.01	1.3 0.05	8.0	4.0	0.0452	0.17 0.39
21.539 0.8480	14.288 0.5625	-9.1 -0.36	1.3 0.05	24.0 0.94	25.5 1.00	1.3 0.05	44.5 1.75	42.0 1.65	2.2 0.09	0.7 0.03	8.0	4.0	0.0452	0.17 0.41
21.539 0.8480	14.288 0.5625	-9.1 -0.36	1.5 0.06	24.0 0.94	26.0 1.02	1.3 0.05	44.5 1.75	42.0 1.65	2.2 0.09	0.7 0.03	8.0	4.0	0.0452	0.17 0.40
19.050 0.7500	17.462 0.6875	-7.4 -0.29	1.3 0.05	24.0 0.94	25.5 1.00	3.5 0.14	44.5 1.75	39.0 1.54	0.4 0.01	1.3 0.05	8.0	4.0	0.0452	0.19 0.42
19.050 0.7500	17.462 0.6875	-7.4 -0.29	1.3 0.05	24.0 0.94	25.5 1.00	1.5 0.06	44.5 1.75	41.5 1.63	0.4 0.01	1.3 0.05	8.0	4.0	0.0452	0.19 0.43
21.539 0.8480	17.462 0.6875	-9.1 -0.36	1.5 0.06	24.0 0.94	26.0 1.02	3.5 0.14	44.5 1.75	39.0 1.54	2.2 0.09	0.7 0.03	8.0	4.0	0.0452	0.19 0.43
21.539 0.8480	17.462 0.6875	-9.1 -0.36	1.5 0.06	24.0 0.94	26.0 1.02	1.5 0.06	44.5 1.75	41.5 1.63	2.2 0.09	0.7 0.03	8.0	4.0	0.0452	0.19 0.45
21.539 0.8480	17.462 0.6875	-9.1 -0.36	1.3 0.05	24.0 0.94	25.5 1.00	3.5 0.14	44.5 1.75	39.0 1.54	2.2 0.09	0.7 0.03	8.0	4.0	0.0452	0.19 0.44
21.539 0.8480	17.462 0.6875	-9.1 -0.36	1.3 0.05	24.0 0.94	25.5 1.00	1.5 0.06	44.5 1.75	41.5 1.63	2.2 0.09	0.7 0.03	8.0	4.0	0.0452	0.19 0.45
21.539 0.8480	17.462 0.6875	-9.1 -0.36	1.5 0.06	24.0 0.94	26.0 1.02	0.5 0.02	45.5 1.79	44.0 1.73	2.2 0.09	0.7 0.03	8.0	4.0	0.0452	0.20 0.47
16.637 0.6550	14.605 0.5750	-5.6 -0.22	1.3 0.05	23.5 0.93	25.0 0.98	1.3 0.05	45.5 1.79	42.0 1.65	0.2 0.01	0.8 0.03	6.6	5.5	0.0441	0.20 0.44
19.050 0.7500	14.684 0.5781	-7.4 -0.29	1.3 0.05	24.0 0.94	25.5 1.00	3.3 0.13	46.5 1.83	42.0 1.65	0.4 0.01	1.3 0.05	8.0	4.0	0.0452	0.21 0.45
21.539 0.8480	14.684 0.5781	-9.1 -0.36	1.5 0.06	24.0 0.94	26.0 1.02	3.3 0.13	46.5 1.83	42.0 1.65	2.2 0.09	0.7 0.03	8.0	4.0	0.0452	0.21 0.47
21.839 0.8598	15.875 0.6250	-5.8 -0.23	1.5 0.06	26.0 1.03	31.5 1.24	2.3 0.09	50.0 1.97	43.0 1.69	3.3 0.13	1.8 0.07	7.0	4.1	0.0558	0.24 0.54
21.839 0.8598	15.875 0.6250	-5.8 -0.23	1.5 0.06	26.0 1.03	31.5 1.24	0.5 0.02	50.0 1.97	44.5 1.75	3.3 0.13	1.8 0.07	7.0	4.1	0.0558	0.25 0.55
21.839 0.8598	15.875 0.6250	-5.8 -0.23	1.5 0.06	26.0 1.03	31.5 1.24	2.3 0.09	50.0 1.97	43.0 1.69	3.3 0.13	1.8 0.07	7.0	4.1	0.0558	0.24 0.54

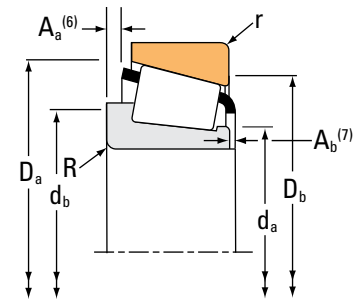
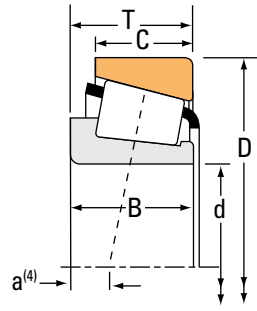
(4) Negative value indicates effective center inside cone (inner-ring) backface.  
 (5) These maximum fillet radii will be cleared by the bearing corners.  
 (6) Negative value indicates cage extends beyond cone (inner-ring) backface.  
 (7) Negative value indicates cage that does not extend beyond cone (inner-ring) front face.

Continued on next page.

# TAPERED ROLLER BEARINGS

## SINGLE-ROW • TYPE TS

### TYPE TS



Bearing Dimensions			Load Ratings							Part Number		
Bore d	O.D. D	Width T	Dynamic <sup>(1)</sup> C <sub>1</sub>		Factors <sup>(2)</sup> e Y		Dynamic <sup>(3)</sup> C <sub>90</sub> C <sub>a90</sub>		Factors <sup>(2)</sup> K	Static C <sub>0</sub>	Inner	Outer
mm in.	mm in.	mm in.	N lbf				N lbf	N lbf		N lbf		
19.050 0.7500	56.896 2.2400	19.368 0.7625	45400 10200	0.31	1.95		11800 2650	6200 1390	1.90	45300 10200	1775	1729
19.987 0.7869	46.982 1.8497	14.381 0.5662	26700 6010	0.36	1.68		6930 1560	4230 952	1.64	25400 5720	05079	05185A
19.987 0.7869	46.990 1.8500	15.250 0.6004	26700 6010	0.36	1.68		6930 1560	4230 952	1.64	25400 5720	05079	05186
19.987 0.7869	47.000 1.8504	14.381 0.5662	26700 6010	0.36	1.68		6930 1560	4230 952	1.64	25400 5720	05079	05185
19.987 0.7869	47.000 1.8504	14.381 0.5662	26700 6010	0.36	1.68		6930 1560	4230 952	1.64	25400 5720	05079	05185-S
19.987 0.7869	51.994 2.0470	15.011 0.5910	27000 6060	0.40	1.49		6990 1570	4810 1080	1.45	29600 6650	07079X	07204
20.000 0.7874	51.994 2.0470	15.011 0.5910	29100 6540	0.40	1.49		7550 1700	5190 1170	1.45	29600 6650	07079	07204
20.627 0.8121	56.896 2.2400	19.368 0.7625	45400 10200	0.31	1.95		11800 2650	6200 1390	1.90	45300 10200	1778	1729
20.637 0.8125	49.225 1.9380	19.845 0.7813	43600 9810	0.32	1.86		11300 2540	6260 1410	1.81	43200 9720	12580	12520
21.430 0.8437	50.005 1.9687	17.526 0.6900	52200 11700	0.28	2.16		13500 3040	6440 1450	2.10	43500 9780	M12649	M12610
21.987 0.8656	45.237 1.7810	15.494 0.6100	38600 8680	0.31	1.96		10000 2250	5250 1180	1.91	35300 7930	LM12749	LM12710
21.987 0.8656	45.975 1.8100	15.494 0.6100	38600 8680	0.31	1.96		10000 2250	5250 1180	1.91	35300 7930	LM12749	LM12711
22.225 0.8750	42.070 1.6563	11.176 0.4400	16600 3730	0.40	1.51		4300 966	2920 655	1.47	16800 3770	LL52549	LL52510
22.225 0.8750	50.005 1.9687	13.495 0.5313	29100 6540	0.40	1.49		7550 1700	5190 1170	1.45	29600 6650	07087	07196
22.225 0.8750	50.005 1.9687	13.495 0.5313	29100 6540	0.40	1.49		7550 1700	5190 1170	1.45	29600 6650	07087X	07196
22.225 0.8750	50.005 1.9687	17.526 0.6900	52200 11700	0.28	2.16		13500 3040	6440 1450	2.10	43500 9780	M12648	M12610
22.225 0.8750	50.005 1.9687	17.526 0.6900	52200 11700	0.28	2.16		13500 3040	6440 1450	2.10	43500 9780	M12648A	M12610

<sup>(1)</sup>Based on 1 x 10<sup>6</sup> revolutions L<sub>10</sub> life, for the ISO life-calculation method.

<sup>(2)</sup>Consult your Timken engineer for instructions on use or review the Timken Engineering Manual on timken.com/catalogs.

<sup>(3)</sup>Based on 90 x 10<sup>6</sup> revolutions L<sub>10</sub> life, for The Timken Company life-calculation method. C<sub>90</sub> and C<sub>a90</sub> are radial and thrust values.

Bearing Dimensions											Geometry Factors			Bearing Weight
Width B	Width C	Eff. Ctr. a <sup>(4)</sup>	Shaft			Housing			Cage		G <sub>1</sub>	G <sub>2</sub>	C <sub>g</sub>	
			Max Shaft Fillet Radius R <sup>(5)</sup>	Backing Shoulder Dia. d <sub>a</sub>	Shoulder Dia. d <sub>b</sub>	Max Housing Fillet Radius r <sup>(5)</sup>	Backing Shoulder Dia. D <sub>a</sub>	Shoulder Dia. D <sub>b</sub>	A <sub>a</sub> <sup>(6)</sup>	A <sub>b</sub> <sup>(7)</sup>				
mm in.	mm in.	mm in.	mm in.	mm in.	mm in.	mm in.	mm in.	mm in.	mm in.	mm in.				kg lbs.
19.837 0.7810	15.875 0.6250	-6.9 -0.27	1.5 0.06	25.0 0.98	27.0 1.06	1.3 0.05	51.0 2.01	49.0 1.93	1.8 0.07	0.4 0.02	10.6	5.4	0.0521	0.26 0.59
14.381 0.5662	11.112 0.4375	-4.1 -0.16	1.5 0.06	24.0 0.94	26.5 1.04	1.5 0.06	42.5 1.67	40.5 1.59	0.2 0.00	1.3 0.05	5.8	5.5	0.0448	0.13 0.26
14.381 0.5662	12.000 0.4724	-4.1 -0.16	1.5 0.06	24.0 0.94	26.5 1.04	1.5 0.06	42.5 1.67	40.5 1.59	0.2 0.00	1.3 0.05	5.8	5.5	0.0448	0.13 0.27
14.381 0.5662	11.112 0.4375	-4.1 -0.16	1.5 0.06	24.0 0.94	26.5 1.04	1.3 0.05	42.5 1.67	40.5 1.59	0.2 0.00	1.3 0.05	5.8	5.5	0.0448	0.13 0.26
14.381 0.5662	11.112 0.4375	-4.1 -0.16	1.5 0.06	24.0 0.94	26.5 1.04	1.5 0.06	42.5 1.67	40.5 1.59	0.2 0.00	1.3 0.05	5.8	5.5	0.0448	0.13 0.26
14.260 0.5614	12.700 0.5000	-2.8 -0.11	1.5 0.06	26.0 1.02	27.5 1.08	1.3 0.05	48.0 1.89	45.0 1.77	0.2 0.01	1.5 0.06	7.6	7.1	0.0509	0.16 0.36
14.260 0.5614	12.700 0.5000	-2.8 -0.11	1.5 0.06	26.0 1.02	27.5 1.08	1.3 0.05	48.0 1.89	45.0 1.77	0.2 0.01	1.5 0.06	7.6	7.1	0.0509	0.16 0.36
19.837 0.7810	15.875 0.6250	-6.9 -0.27	0.8 0.03	26.0 1.02	27.0 1.06	1.3 0.05	51.0 2.01	49.0 1.93	* *	* *	10.6	5.4	0.0521	0.26 0.57
19.845 0.7813	15.875 0.6250	-7.1 -0.28	1.5 0.06	26.0 1.02	28.5 1.12	1.5 0.06	45.5 1.79	42.5 1.67	0.8 0.03	1.2 0.05	8.6	6.2	0.0495	0.18 0.40
18.288 0.7200	13.970 0.5500	-6.4 -0.25	1.3 0.05	27.5 1.08	29.5 1.16	1.3 0.05	46.0 1.81	44.0 1.73	0.3 0.01	1.2 0.05	9.1	5.6	0.0479	0.17 0.37
16.637 0.6550	12.065 0.4750	-5.3 -0.21	1.3 0.05	26.0 1.02	27.5 1.08	1.3 0.05	42.0 1.65	39.5 1.56	0.5 0.02	0.5 0.02	8.2	7.4	0.0480	0.12 0.26
16.637 0.6550	12.065 0.4750	-5.3 -0.21	1.3 0.05	26.0 1.02	27.5 1.08	1.3 0.05	42.5 1.67	40.0 1.57	0.5 0.02	0.5 0.02	8.2	7.4	0.0480	0.12 0.27
11.176 0.4400	8.636 0.3400	-1.8 -0.07	1.3 0.05	26.0 1.02	27.5 1.08	1.3 0.05	39.5 1.56	36.5 1.44	-0.2 -0.01	1.2 0.05	4.7	8.6	0.0431	0.06 0.15
14.260 0.5614	9.525 0.3750	-2.8 -0.11	1.3 0.05	27.0 1.06	28.5 1.12	1.0 0.04	47.0 1.85	44.5 1.75	0.2 0.01	1.5 0.06	7.6	7.1	0.0509	0.12 0.28
14.260 0.5614	9.525 0.3750	-2.8 -0.11	1.5 0.06	27.0 1.06	29.0 1.14	1.0 0.04	47.0 1.85	44.5 1.75	0.2 0.01	1.5 0.06	7.6	7.1	0.0509	0.12 0.28
18.288 0.7200	13.970 0.5500	-6.4 -0.25	1.3 0.05	26.5 1.04	28.5 1.12	1.3 0.05	46.0 1.81	44.0 1.73	0.3 0.01	1.2 0.05	9.1	5.6	0.0479	0.16 0.36
18.288 0.7200	13.970 0.5500	-6.4 -0.25	0.4 0.02	26.5 1.04	26.5 1.04	1.3 0.05	46.0 1.81	44.0 1.73	0.3 0.01	1.2 0.05	9.1	5.6	0.0479	0.16 0.36

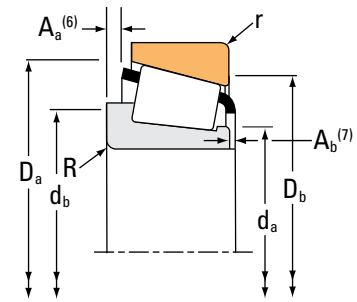
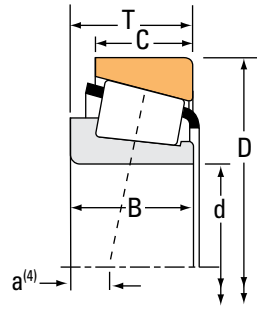
(4) Negative value indicates effective center inside cone (inner-ring) backface.  
 (5) These maximum fillet radii will be cleared by the bearing corners.  
 (6) Negative value indicates cage extends beyond cone (inner-ring) backface.  
 (7) Negative value indicates cage that does not extend beyond cone (inner-ring) front face.  
 (\*) Contact your Timken engineer for details.

Continued on next page.

# TAPERED ROLLER BEARINGS

## SINGLE-ROW • TYPE TS

### TYPE TS



Bearing Dimensions			Load Ratings							Part Number		
Bore d	O.D. D	Width T	Dynamic <sup>(1)</sup> C <sub>1</sub>		Factors <sup>(2)</sup> e Y		Dynamic <sup>(3)</sup> C <sub>90</sub> C <sub>a90</sub>		Factors <sup>(2)</sup> K	Static C <sub>0</sub>	Inner	Outer
mm in.	mm in.	mm in.	N lbf				N lbf	N lbf		N lbf		
22.225 0.8750	51.994 2.0470	15.011 0.5910	29100 6540	0.40	1.49		7550 1700	5190 1170	1.45	29600 6650	07087	07204
22.225 0.8750	52.000 2.0472	15.011 0.5910	29100 6540	0.40	1.49		7550 1700	5190 1170	1.45	29600 6650	07087X	07205
22.225 0.8750	52.388 2.0625	19.368 0.7625	47900 10800	0.29	2.05		12400 2790	6200 1390	2.00	48300 10900	1380	1328
22.225 0.8750	53.975 2.1250	19.368 0.7625	47900 10800	0.29	2.05		12400 2790	6200 1390	2.00	48300 10900	1380	1329
22.225 0.8750	53.975 2.1250	19.368 0.7625	45400 10200	0.31	1.95		11800 2650	6200 1390	1.90	45300 10200	1755	1730
22.225 0.8750	56.896 2.2400	19.368 0.7625	45400 10200	0.31	1.95		11800 2650	6200 1390	1.90	45300 10200	1755	1729
22.225 0.8750	56.896 2.2400	19.368 0.7625	45400 10200	0.31	1.95		11800 2650	6200 1390	1.90	45300 10200	1755	1729X
22.225 0.8750	57.150 2.2500	19.845 0.7813	48400 10900	0.33	1.82		12500 2820	7080 1590	1.77	50200 11300	1975	1922
22.225 0.8750	57.150 2.2500	22.225 0.8750	55300 12400	0.35	1.73		14300 3230	8510 1910	1.69	55100 12400	1280	1220
22.225 0.8750	58.738 2.3125	19.050 0.7500	48400 10900	0.33	1.82		12500 2820	7080 1590	1.77	50200 11300	1975	1932
22.225 0.8750	60.325 2.3750	19.845 0.7813	48400 10900	0.33	1.82		12500 2820	7080 1590	1.77	50200 11300	1975	1931
22.225 0.8750	61.912 2.4375	36.512 1.4375	88600 19900	0.28	2.13		23000 5160	11100 2500	2.07	89800 20200	3655	3620
22.225 0.8750	62.000 2.4409	17.983 0.7080	48200 10800	0.24	2.48		12500 2810	5170 1160	2.42	49200 11100	246X	242
22.225 0.8750	66.421 2.6150	23.813 0.9375	76600 17200	0.25	2.36		19900 4470	8640 1940	2.30	81700 18400	2684	2631
22.606 0.8900	47.000 1.8504	15.500 0.6102	35100 7900	0.47	1.27		9110 2050	7380 1660	1.24	33000 7420	LM72849	LM72810
23.812 0.9375	50.005 1.9687	13.495 0.5313	29100 6540	0.40	1.49		7550 1700	5190 1170	1.45	29600 6650	07093	07196
23.812 0.9375	50.292 1.9800	14.224 0.5600	35600 8010	0.37	1.60		9230 2080	5910 1330	1.56	32900 7400	L44640	L44610

<sup>(1)</sup>Based on 1 x 10<sup>6</sup> revolutions L<sub>10</sub> life, for the ISO life-calculation method.

<sup>(2)</sup>Consult your Timken engineer for instructions on use or review the Timken Engineering Manual on timken.com/catalogs.

<sup>(3)</sup>Based on 90 x 10<sup>6</sup> revolutions L<sub>10</sub> life, for The Timken Company life-calculation method. C<sub>90</sub> and C<sub>a90</sub> are radial and thrust values.

Bearing Dimensions											Geometry Factors			Bearing Weight
Width B	Width C	Eff. Ctr. a <sup>(4)</sup>	Shaft			Housing			Cage		G <sub>1</sub>	G <sub>2</sub>	C <sub>g</sub>	
			Max Shaft Fillet Radius R <sup>(5)</sup>	Backing Shoulder Dia. d <sub>a</sub>	Shoulder Dia. d <sub>b</sub>	Max Housing Fillet Radius r <sup>(5)</sup>	Backing Shoulder Dia. D <sub>a</sub>	Shoulder Dia. D <sub>b</sub>	A <sub>a</sub> <sup>(6)</sup>	A <sub>b</sub> <sup>(7)</sup>				
mm in.	mm in.	mm in.	mm in.	mm in.	mm in.	mm in.	mm in.	mm in.	mm in.	mm in.				kg lbs.
14.260 0.5614	12.700 0.5000	-2.8 -0.11	1.3 0.05	27.0 1.06	28.5 1.12	1.3 0.05	48.0 1.89	45.0 1.77	0.2 0.01	1.5 0.06	7.6	7.1	0.0509	0.15 0.34
14.260 0.5614	12.700 0.5000	-2.8 -0.11	1.5 0.06	27.0 1.06	29.0 1.14	2.0 0.08	48.0 1.89	44.5 1.75	0.2 0.01	1.5 0.06	7.6	7.1	0.0509	0.15 0.34
20.168 0.7940	14.288 0.5625	-7.6 -0.30	1.5 0.06	27.0 1.06	29.5 1.16	1.5 0.06	48.5 1.91	45.0 1.77	1.3 0.05	1.1 0.05	10.3	5.2	0.0508	0.20 0.45
20.168 0.7940	14.288 0.5625	-7.6 -0.30	1.5 0.06	27.0 1.06	29.5 1.16	1.5 0.06	49.0 1.93	46.0 1.81	1.3 0.05	1.1 0.05	10.3	5.2	0.0508	0.21 0.48
19.837 0.7810	15.875 0.6250	-6.9 -0.27	1.3 0.05	27.5 1.08	29.0 1.14	0.8 0.03	50.0 1.97	48.5 1.91	1.8 0.07	0.4 0.02	10.6	5.4	0.0521	0.22 0.49
19.837 0.7810	15.875 0.6250	-6.9 -0.27	1.3 0.05	27.5 1.08	29.0 1.14	1.3 0.05	51.0 2.01	49.0 1.93	1.8 0.07	0.4 0.02	10.6	5.4	0.0521	0.25 0.56
19.837 0.7810	15.875 0.6250	-6.9 -0.27	1.3 0.05	27.5 1.08	29.0 1.14	1.5 0.06	51.0 2.01	49.0 1.93	1.8 0.07	0.4 0.02	10.6	5.4	0.0521	0.25 0.55
19.355 0.7620	15.875 0.6250	-5.8 -0.23	0.8 0.03	29.5 1.16	30.5 1.20	1.5 0.06	53.5 2.11	51.0 2.01	0.7 0.03	1.2 0.05	12.5	6.3	0.0565	0.26 0.57
22.225 0.8750	17.462 0.6875	-6.9 -0.27	0.8 0.03	29.0 1.14	29.5 1.16	1.5 0.06	52.0 2.05	49.0 1.93	* *	* *	11.4	5.5	0.0556	0.28 0.63
19.355 0.7620	15.080 0.5937	-5.8 -0.23	0.8 0.03	29.5 1.16	30.5 1.20	1.3 0.05	54.0 2.13	52.0 2.05	0.7 0.03	1.2 0.05	12.5	6.3	0.0565	0.27 0.60
19.355 0.7620	15.875 0.6250	-5.8 -0.23	0.8 0.03	29.5 1.16	30.5 1.20	1.3 0.05	55.0 2.17	52.0 2.05	0.7 0.03	1.2 0.05	12.5	6.3	0.0565	0.29 0.65
38.354 1.5100	23.812 0.9375	-19.8 -0.78	0.3 0.01	30.5 1.20	30.5 1.20	3.3 0.13	58.0 2.27	52.0 2.05	9.8 0.38	0.2 0.01	17.0	6.4	0.0592	0.52 1.12
19.000 0.7480	16.002 0.6300	-6.1 -0.24	3.5 0.14	30.0 1.18	34.5 1.36	2.0 0.08	57.0 2.24	55.0 2.17	0.0 0.00	0.8 0.03	12.8	8.2	0.0509	0.29 0.63
25.433 1.0013	19.050 0.7500	-9.4 -0.37	1.5 0.06	32.0 1.26	34.0 1.34	1.3 0.05	60.0 2.36	58.0 2.28	0.7 0.03	0.8 0.04	19.3	8.0	0.0598	0.46 1.02
15.500 0.6102	12.000 0.4724	-3.0 -0.12	1.5 0.06	28.0 1.10	30.0 1.18	1.0 0.04	44.0 1.73	40.5 1.59	0.6 0.02	0.9 0.04	7.5	9.0	0.0538	0.13 0.28
14.260 0.5614	9.525 0.3750	-2.8 -0.11	1.5 0.06	28.5 1.12	30.5 1.20	1.0 0.04	47.0 1.85	44.5 1.75	0.2 0.01	1.5 0.06	7.6	7.1	0.0509	0.12 0.27
14.732 0.5800	10.668 0.4200	-3.3 -0.13	1.5 0.06	28.5 1.12	30.5 1.20	1.3 0.05	47.0 1.85	44.5 1.75	0.8 0.03	0.6 0.03	8.9	8.9	0.0526	0.14 0.29

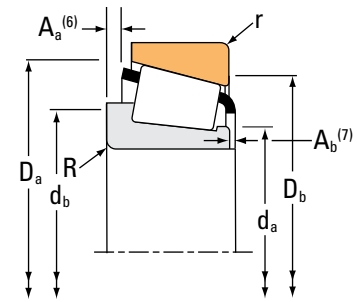
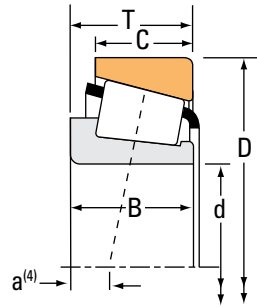
(4) Negative value indicates effective center inside cone (inner-ring) backface.  
 (5) These maximum fillet radii will be cleared by the bearing corners.  
 (6) Negative value indicates cage extends beyond cone (inner-ring) backface.  
 (7) Negative value indicates cage that does not extend beyond cone (inner-ring) front face.  
 (\*) Contact your Timken engineer for details.

Continued on next page.

# TAPERED ROLLER BEARINGS

## SINGLE-ROW • TYPE TS

### TYPE TS



Bearing Dimensions			Load Ratings						Part Number			
Bore d	O.D. D	Width T	Dynamic <sup>(1)</sup>		Factors <sup>(2)</sup>		Dynamic <sup>(3)</sup>		Static		Inner	Outer
			C <sub>1</sub>	e	Y	C <sub>90</sub>	C <sub>a90</sub>	K	C <sub>0</sub>			
mm in.	mm in.	mm in.	N lbf			N lbf	N lbf		N lbf			
23.812 0.9375	50.800 2.0000	15.011 0.5910	29100 6540	0.40	1.49	7550 1700	5190 1170	1.45	29600 6650		07093	07210X
23.812 0.9375	51.994 2.0470	15.012 0.5910	29100 6540	0.40	1.49	7550 1700	5190 1170	1.45	29600 6650		07093	07204
23.812 0.9375	53.975 2.1250	19.368 0.7625	45400 10200	0.31	1.95	11800 2650	6200 1390	1.90	45300 10200		1779	1730
23.812 0.9375	56.896 2.2400	19.368 0.7625	45400 10200	0.31	1.95	11800 2650	6200 1390	1.90	45300 10200		1779	1729
23.812 0.9375	61.912 2.4375	28.575 1.1250	88600 19900	0.28	2.13	23000 5160	11100 2500	2.07	89800 20200		3659	3620
23.812 0.9375	65.088 2.5625	22.225 0.8750	54600 12300	0.73	0.82	14200 3180	17700 3990	0.80	55800 12500		23092	23256
23.812 0.9375	66.421 2.6150	23.812 0.9375	76600 17200	0.25	2.36	19900 4470	8640 1940	2.30	81700 18400		2685	2631
24.000 0.9449	55.000 2.1654	25.000 0.9842	79500 17900	0.35	1.70	20600 4630	12500 2800	1.65	71000 16000	JHM33449		JHM33410
24.384 0.9600	79.375 3.1250	25.400 1.0000	92000 20700	0.67	0.90	23900 5360	27300 6130	0.87	76200 17100		43096	43312
24.981 0.9835	50.005 1.9687	13.495 0.5313	29100 6540	0.40	1.49	7550 1700	5190 1170	1.45	29600 6650		07098	07196
24.981 0.9835	51.994 2.0470	15.011 0.5910	29100 6540	0.40	1.49	7550 1700	5190 1170	1.45	29600 6650		07098	07204
24.981 0.9835	52.000 2.0472	15.011 0.5910	29100 6540	0.40	1.49	7550 1700	5190 1170	1.45	29600 6650		07098	07205
24.981 0.9835	61.981 2.4402	16.002 0.6300	43200 9720	0.38	1.57	11200 2520	7340 1650	1.53	44100 9910		17098	17244A
24.981 0.9835	62.000 2.4409	16.002 0.6300	43200 9720	0.38	1.57	11200 2520	7340 1650	1.53	44100 9910		17098	17244
25.000 0.9843	50.005 1.9687	13.495 0.5313	29100 6540	0.40	1.49	7550 1700	5190 1170	1.45	29600 6650		07097	07196
25.000 0.9843	51.994 2.0470	15.011 0.5910	29100 6540	0.40	1.49	7550 1700	5190 1170	1.45	29600 6650		07097	07204
25.000 0.9843	52.000 2.0472	14.224 0.5600	35600 8010	0.37	1.60	9230 2080	5910 1330	1.56	32900 7400	JL44642A		JL44615

<sup>(1)</sup>Based on  $1 \times 10^6$  revolutions  $L_{10}$  life, for the ISO life-calculation method.

<sup>(2)</sup>Consult your Timken engineer for instructions on use or review the Timken Engineering Manual on [timken.com/catalogs](http://timken.com/catalogs).

<sup>(3)</sup>Based on  $90 \times 10^6$  revolutions  $L_{10}$  life, for The Timken Company life-calculation method.  $C_{90}$  and  $C_{a90}$  are radial and thrust values.

Bearing Dimensions											Geometry Factors			Bearing Weight
Width B	Width C	Eff. Ctr. a <sup>(4)</sup>	Shaft			Housing			Cage		G <sub>1</sub>	G <sub>2</sub>	C <sub>g</sub>	
			Max Shaft Fillet Radius R <sup>(5)</sup>	Backing Shoulder Dia. d <sub>a</sub>	Shoulder Dia. d <sub>b</sub>	Max Housing Fillet Radius r <sup>(5)</sup>	Backing Shoulder Dia. D <sub>a</sub>	Shoulder Dia. D <sub>b</sub>	A <sub>a</sub> <sup>(6)</sup>	A <sub>b</sub> <sup>(7)</sup>				
mm in.	mm in.	mm in.	mm in.	mm in.	mm in.	mm in.	mm in.	mm in.	mm in.	mm in.				kg lbs.
14.260 0.5614	12.700 0.5000	-2.8 -0.11	1.5 0.06	28.5 1.12	30.5 1.20	1.5 0.06	47.5 1.87	44.5 1.75	0.2 0.01	1.5 0.06	7.6	7.1	0.0509	0.14 0.30
14.260 0.5614	12.700 0.5000	-2.8 -0.11	1.5 0.06	28.5 1.12	30.5 1.20	1.3 0.05	48.0 1.89	45.0 1.77	0.2 0.01	1.5 0.06	7.6	7.1	0.0509	0.15 0.33
19.837 0.7810	15.875 0.6250	-6.9 -0.27	0.8 0.03	28.5 1.12	29.5 1.16	0.8 0.03	50.0 1.97	48.5 1.91	1.8 0.07	0.4 0.02	10.6	5.4	0.0521	0.21 0.47
19.837 0.7810	15.875 0.6250	-6.9 -0.27	0.8 0.03	28.5 1.12	29.5 1.16	1.3 0.05	51.0 2.01	49.0 1.93	1.8 0.07	0.4 0.02	10.6	5.4	0.0521	0.24 0.54
30.417 1.1975	23.812 0.9375	-11.9 -0.47	2.3 0.09	31.5 1.24	35.5 1.40	3.3 0.13	58.0 2.27	52.0 2.05	1.9 0.07	0.2 0.01	17.0	6.4	0.0592	0.44 0.96
21.463 0.8450	15.875 0.6250	-2.3 -0.09	1.5 0.06	34.5 1.36	38.5 1.52	1.5 0.06	63.0 2.48	53.0 2.09	3.7 0.14	2.1 0.08	11.3	6.6	0.0700	0.36 0.81
25.433 1.0013	19.050 0.7500	-9.4 -0.37	0.8 0.03	30.0 1.18	31.0 1.22	1.3 0.05	60.0 2.36	58.0 2.28	0.7 0.03	0.8 0.04	19.3	8.0	0.0598	0.44 0.99
25.000 0.9843	21.000 0.8268	-8.9 -0.35	2.0 0.08	30.0 1.18	35.0 1.38	2.0 0.08	52.0 2.05	47.0 1.85	0.4 0.01	1.8 0.07	13.3	5.8	0.0592	0.29 0.65
24.074 0.9478	17.462 0.6875	-2.0 -0.08	0.8 0.03	39.5 1.56	40.5 1.59	1.5 0.06	74.0 2.91	67.0 2.64	3.4 0.13	2.4 0.10	16.8	7.6	0.0774	0.65 1.42
14.260 0.5614	9.525 0.3750	-2.8 -0.11	1.5 0.06	29.0 1.14	31.0 1.22	1.0 0.04	47.0 1.85	44.5 1.75	0.2 0.01	1.5 0.06	7.6	7.1	0.0509	0.11 0.26
14.260 0.5614	12.700 0.5000	-2.8 -0.11	1.5 0.06	29.0 1.14	31.0 1.22	1.3 0.05	48.0 1.89	45.0 1.77	0.2 0.01	1.5 0.06	7.6	7.1	0.0509	0.14 0.31
14.260 0.5614	12.700 0.5000	-2.8 -0.11	1.5 0.06	29.0 1.14	31.0 1.22	2.0 0.08	48.0 1.89	44.5 1.75	0.2 0.01	1.5 0.06	7.6	7.1	0.0509	0.14 0.31
16.566 0.6522	14.288 0.5625	-3.6 -0.14	1.5 0.06	30.5 1.20	33.0 1.30	1.5 0.06	57.0 2.24	54.0 2.13	0.2 0.01	1.9 0.08	11.8	7.5	0.0579	0.25 0.56
16.566 0.6522	14.288 0.5625	-3.6 -0.14	1.5 0.06	30.5 1.20	33.0 1.30	1.5 0.06	57.0 2.24	54.0 2.13	0.2 0.01	1.9 0.08	11.8	7.5	0.0579	0.27 0.60
14.260 0.5614	9.525 0.3750	-2.8 -0.11	1.5 0.06	29.0 1.14	31.0 1.22	1.0 0.04	47.0 1.85	44.5 1.75	0.2 0.01	1.5 0.06	7.6	7.1	0.0509	0.11 0.26
14.260 0.5614	12.700 0.5000	-2.8 -0.11	1.5 0.06	29.0 1.14	31.0 1.22	1.3 0.05	48.0 1.89	45.0 1.77	0.2 0.01	1.5 0.06	7.6	7.1	0.0509	0.14 0.31
14.732 0.5800	10.668 0.4200	-3.3 -0.13	1.3 0.05	30.0 1.18	32.0 1.26	1.3 0.05	48.0 1.89	45.5 1.79	0.8 0.03	0.6 0.03	8.9	8.9	0.0526	0.14 0.31

<sup>(4)</sup>Negative value indicates effective center inside cone (inner-ring) backface.

<sup>(5)</sup>These maximum fillet radii will be cleared by the bearing corners.

<sup>(6)</sup>Negative value indicates cage extends beyond cone (inner-ring) backface.

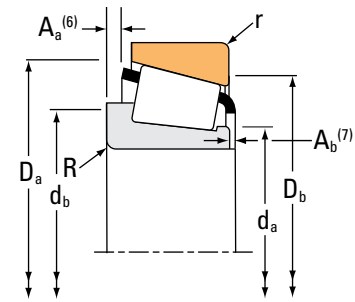
<sup>(7)</sup>Negative value indicates cage that does not extend beyond cone (inner-ring) front face.

Continued on next page.

# TAPERED ROLLER BEARINGS

## SINGLE-ROW • TYPE TS

### TYPE TS



Bearing Dimensions			Load Ratings					Part Number					
Bore d	O.D. D	Width T	Dynamic <sup>(1)</sup>		Factors <sup>(2)</sup>		Dynamic <sup>(3)</sup>		Factors <sup>(2)</sup>		Static C <sub>0</sub>	Inner	Outer
			C <sub>1</sub>	e	Y	C <sub>90</sub>	C <sub>a90</sub>	K	N	N			
mm in.	mm in.	mm in.	N lbf			N lbf	N lbf		N lbf				
25.000 0.9843	52.000 2.0472	15.011 0.5910	29100 6540	0.40	1.49	7550 1700	5190 1170	1.45	29600 6650		07097	07205	
25.000 0.9843	61.912 2.4375	21.018 0.8275	48200 10800	0.24	2.48	12500 2810	5170 1160	2.42	49200 11100		247	244X	
25.400 1.0000	50.005 1.9687	13.495 0.5313	29100 6540	0.40	1.49	7550 1700	5190 1170	1.45	29600 6650		07100-S	07196	
25.400 1.0000	50.292 1.9800	14.224 0.5600	35600 8010	0.37	1.60	9230 2080	5910 1330	1.56	32900 7400		L44643	L44610	
25.400 1.0000	50.292 1.9800	14.224 0.5600	35600 8010	0.37	1.60	9230 2080	5910 1330	1.56	32900 7400		L44642	L44610	
25.400 1.0000	50.800 2.0000	15.011 0.5910	29100 6540	0.40	1.49	7550 1700	5190 1170	1.45	29600 6650		07100-S	07210X	
25.400 1.0000	50.800 2.0000	15.011 0.5910	29100 6540	0.40	1.49	7550 1700	5190 1170	1.45	29600 6650		07100-SA	07210X	
25.400 1.0000	51.986 2.0467	15.011 0.5910	35600 8010	0.37	1.60	9230 2080	5910 1330	1.56	32900 7400		L44643	L44613	
25.400 1.0000	52.000 2.0472	15.011 0.5910	29100 6540	0.40	1.49	7550 1700	5190 1170	1.45	29600 6650		07100-SA	07205	
25.400 1.0000	52.000 2.0472	15.011 0.5910	29100 6540	0.40	1.49	7550 1700	5190 1170	1.45	29600 6650		07100-S	07205	
25.400 1.0000	53.975 2.1250	19.368 0.7625	45400 10200	0.31	1.95	11800 2650	6200 1390	1.90	45300 10200		1780	1730	
25.400 1.0000	56.896 2.2400	19.368 0.7625	45400 10200	0.31	1.95	11800 2650	6200 1390	1.90	45300 10200		1780	1729	
25.400 1.0000	57.150 2.2500	17.462 0.6875	54500 12300	0.35	1.73	14100 3180	8380 1880	1.69	50100 11300		15578	15520	
25.400 1.0000	57.150 2.2500	19.431 0.7650	48500 10900	0.55	1.10	12600 2830	11800 2640	1.07	52900 11900		M84548	M84510	
25.400 1.0000	57.150 2.2500	19.845 0.7813	48400 10900	0.33	1.82	12500 2820	7080 1590	1.77	50200 11300		1986	1922	
25.400 1.0000	57.150 2.2500	19.845 0.7813	48400 10900	0.33	1.82	12500 2820	7080 1590	1.77	50200 11300		1994X	1922	
25.400 1.0000	57.150 2.2500	20.218 0.7960	45400 10200	0.31	1.95	11800 2650	6200 1390	1.90	45300 10200		1780	1738X	

<sup>(1)</sup>Based on 1 x 10<sup>6</sup> revolutions L<sub>10</sub> life, for the ISO life-calculation method.

<sup>(2)</sup>Consult your Timken engineer for instructions on use or review the Timken Engineering Manual on timken.com/catalogs.

<sup>(3)</sup>Based on 90 x 10<sup>6</sup> revolutions L<sub>10</sub> life, for The Timken Company life-calculation method. C<sub>90</sub> and C<sub>a90</sub> are radial and thrust values.



Bearing Dimensions											Geometry Factors			Bearing Weight
Width B	Width C	Eff. Ctr. a <sup>(4)</sup>	Shaft			Housing			Cage		G <sub>1</sub>	G <sub>2</sub>	C <sub>g</sub>	
			Max Shaft Fillet Radius R <sup>(5)</sup>	Backing Shoulder Dia. d <sub>a</sub>	Shoulder Dia. d <sub>b</sub>	Max Housing Fillet Radius r <sup>(5)</sup>	Backing Shoulder Dia. D <sub>a</sub>	Shoulder Dia. D <sub>b</sub>	A <sub>a</sub> <sup>(6)</sup>	A <sub>b</sub> <sup>(7)</sup>				
mm in.	mm in.	mm in.	mm in.	mm in.	mm in.	mm in.	mm in.	mm in.	mm in.	mm in.				kg lbs.
14.260 0.5614	12.700 0.5000	-2.8 -0.11	1.5 0.06	29.0 1.14	31.0 1.22	2.0 0.08	48.0 1.89	44.5 1.75	0.2 0.01	1.5 0.06	7.6	7.1	0.0509	0.14 0.31
19.000 0.7480	17.462 0.6875	-6.1 -0.24	2.0 0.08	30.0 1.18	33.5 1.32	3.3 0.13	57.0 2.24	52.0 2.05	0.0 0.00	0.8 0.03	12.8	8.2	0.0509	0.28 0.63
14.260 0.5614	9.525 0.3750	-2.8 -0.11	1.5 0.06	29.5 1.16	31.5 1.24	1.0 0.04	47.0 1.85	44.5 1.75	0.2 0.01	1.5 0.06	7.6	7.1	0.0509	0.11 0.25
14.732 0.5800	10.668 0.4200	-3.3 -0.13	1.3 0.05	30.0 1.18	32.0 1.26	1.3 0.05	47.0 1.85	44.5 1.75	0.7 0.03	0.6 0.03	8.9	8.9	0.0526	0.13 0.28
14.732 0.5800	10.668 0.4200	-3.3 -0.13	3.5 0.14	29.5 1.16	36.0 1.42	1.3 0.05	47.0 1.85	44.5 1.75	0.8 0.03	0.6 0.03	8.9	8.9	0.0526	0.13 0.27
14.260 0.5614	12.700 0.5000	-2.8 -0.11	1.5 0.06	29.5 1.16	31.5 1.24	1.5 0.06	47.5 1.87	44.5 1.75	0.2 0.01	1.5 0.06	7.6	7.1	0.0509	0.13 0.29
14.260 0.5614	12.700 0.5000	-2.8 -0.11	3.3 0.13	29.5 1.16	35.0 1.38	1.5 0.06	47.5 1.87	44.5 1.75	0.2 0.01	1.5 0.06	7.6	7.1	0.0509	0.13 0.28
14.732 0.5800	12.700 0.5000	-3.3 -0.13	1.3 0.05	30.0 1.18	32.0 1.26	2.0 0.08	48.0 1.89	44.5 1.75	0.7 0.03	0.6 0.03	8.9	8.9	0.0526	0.15 0.32
14.260 0.5614	12.700 0.5000	-2.8 -0.11	3.3 0.13	29.5 1.16	35.0 1.38	2.0 0.08	48.0 1.89	44.5 1.75	0.2 0.01	1.5 0.06	7.6	7.1	0.0509	0.14 0.30
14.260 0.5614	12.700 0.5000	-2.8 -0.11	1.5 0.06	29.5 1.16	31.5 1.24	2.0 0.08	48.0 1.89	44.5 1.75	0.2 0.01	1.5 0.06	7.6	7.1	0.0509	0.14 0.31
19.837 0.7810	15.875 0.6250	-6.9 -0.27	0.8 0.03	30.0 1.18	30.5 1.20	0.8 0.03	50.0 1.97	48.5 1.91	1.8 0.07	0.4 0.02	10.6	5.4	0.0521	0.20 0.45
19.837 0.7810	15.875 0.6250	-6.9 -0.27	0.8 0.03	30.0 1.18	30.5 1.20	1.3 0.05	51.0 2.01	49.0 1.93	1.8 0.07	0.4 0.02	10.6	5.4	0.0521	0.23 0.52
17.462 0.6875	13.495 0.5313	-5.1 -0.20	1.3 0.05	30.5 1.20	32.5 1.28	1.5 0.06	53.0 2.09	51.0 2.01	0.5 0.02	1.9 0.08	12.7	10.3	0.0577	0.22 0.48
19.431 0.7650	14.732 0.5800	-3.0 -0.12	1.5 0.06	33.0 1.30	38.5 1.52	1.5 0.06	54.0 2.13	48.5 1.91	1.1 0.04	1.3 0.05	11.3	7.4	0.0644	0.25 0.53
19.355 0.7620	15.875 0.6250	-5.8 -0.23	1.3 0.05	32.0 1.26	34.0 1.34	1.5 0.06	53.5 2.11	51.0 2.01	0.7 0.03	1.2 0.05	12.5	6.3	0.0565	0.25 0.53
19.355 0.7620	15.875 0.6250	-5.8 -0.23	3.5 0.14	30.5 1.20	37.0 1.46	1.5 0.06	53.5 2.11	51.0 2.01	0.7 0.03	1.2 0.05	12.5	6.3	0.0565	0.24 0.52
19.837 0.7810	17.550 0.6910	-6.9 -0.27	0.8 0.03	30.0 1.18	30.5 1.20	2.3 0.09	51.0 2.01	48.5 1.91	1.8 0.07	0.4 0.02	10.6	5.4	0.0521	0.25 0.55

<sup>(4)</sup>Negative value indicates effective center inside cone (inner-ring) backface.

<sup>(5)</sup>These maximum fillet radii will be cleared by the bearing corners.

<sup>(6)</sup>Negative value indicates cage extends beyond cone (inner-ring) backface.

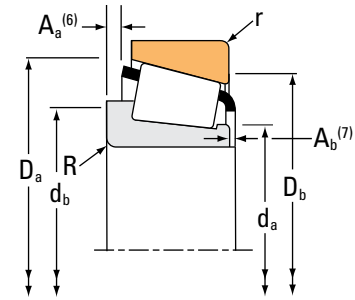
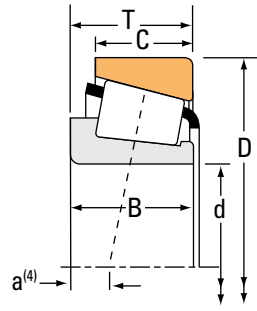
<sup>(7)</sup>Negative value indicates cage that does not extend beyond cone (inner-ring) front face.

Continued on next page.

# TAPERED ROLLER BEARINGS

## SINGLE-ROW • TYPE TS

### TYPE TS



Bearing Dimensions			Load Ratings						Part Number		
Bore d	O.D. D	Width T	Dynamic <sup>(1)</sup> C <sub>1</sub>	Factors <sup>(2)</sup> e	Y	Dynamic <sup>(3)</sup> C <sub>90</sub>	C <sub>a90</sub>	Factors <sup>(2)</sup> K	Static C <sub>0</sub>	Inner	Outer
mm in.	mm in.	mm in.	N lbf			N lbf	N lbf		N lbf		
25.400 1.0000	58.738 2.3125	19.050 0.7500	48400 10900	0.33	1.82	12500 2820	7080 1590	1.77	50200 11300	1986	1932
25.400 1.0000	59.530 2.3437	23.368 0.9200	58100 13100	0.55	1.10	15100 3390	14100 3170	1.07	63300 14200	M84249	M84210
25.400 1.0000	60.325 2.3750	19.842 0.7812	54500 12300	0.35	1.73	14100 3180	8380 1880	1.69	50100 11300	15578	15523
25.400 1.0000	60.325 2.3750	19.845 0.7813	48400 10900	0.33	1.82	12500 2820	7080 1590	1.77	50200 11300	1986	1931
25.400 1.0000	60.325 2.3750	19.845 0.7813	48400 10900	0.33	1.82	12500 2820	7080 1590	1.77	50200 11300	1994X	1931
25.400 1.0000	62.000 2.4409	18.161 0.7150	59900 13500	0.35	1.71	15500 3490	9310 2090	1.67	53900 12100	15100-SR	15245
25.400 1.0000	62.000 2.4409	19.050 0.7500	59900 13500	0.35	1.71	15500 3490	9310 2090	1.67	53900 12100	15101	15245
25.400 1.0000	62.000 2.4409	19.050 0.7500	59900 13500	0.35	1.71	15500 3490	9310 2090	1.67	53900 12100	15100	15245
25.400 1.0000	62.000 2.4409	19.050 0.7500	59900 13500	0.35	1.71	15500 3490	9310 2090	1.67	53900 12100	15102	15245
25.400 1.0000	62.000 2.4409	20.638 0.8125	59900 13500	0.35	1.71	15500 3490	9310 2090	1.67	53900 12100	15100	15244
25.400 1.0000	62.000 2.4409	20.638 0.8125	59900 13500	0.35	1.71	15500 3490	9310 2090	1.67	53900 12100	15101	15244
25.400 1.0000	63.100 2.4843	23.812 0.9375	76600 17200	0.25	2.36	19900 4470	8640 1940	2.30	81700 18400	2687	2630
25.400 1.0000	63.500 2.5000	20.638 0.8125	59900 13500	0.35	1.71	15500 3490	9310 2090	1.67	53900 12100	15100	15250
25.400 1.0000	63.500 2.5000	20.638 0.8125	59900 13500	0.35	1.71	15500 3490	9310 2090	1.67	53900 12100	15101	15250
25.400 1.0000	63.500 2.5000	20.638 0.8125	59900 13500	0.35	1.71	15500 3490	9310 2090	1.67	53900 12100	15101	15250X
25.400 1.0000	63.500 2.5000	20.638 0.8125	59900 13500	0.35	1.71	15500 3490	9310 2090	1.67	53900 12100	15102	15250
25.400 1.0000	63.500 2.5000	20.638 0.8125	54600 12300	0.73	0.82	14200 3180	17700 3990	0.80	55800 12500	23101X	23250X

<sup>(1)</sup>Based on 1 x 10<sup>6</sup> revolutions L<sub>10</sub> life, for the ISO life-calculation method.

<sup>(2)</sup>Consult your Timken engineer for instructions on use or review the Timken Engineering Manual on timken.com/catalogs.

<sup>(3)</sup>Based on 90 x 10<sup>6</sup> revolutions L<sub>10</sub> life, for The Timken Company life-calculation method. C<sub>90</sub> and C<sub>a90</sub> are radial and thrust values.

Bearing Dimensions											Geometry Factors			Bearing Weight
Width B	Width C	Eff. Ctr. a <sup>(4)</sup>	Shaft			Housing			Cage		G <sub>1</sub>	G <sub>2</sub>	C <sub>g</sub>	
			Max Shaft Fillet Radius R <sup>(5)</sup>	Backing Shoulder Dia. d <sub>a</sub>	Backing Shoulder Dia. d <sub>b</sub>	Max Housing Fillet Radius r <sup>(5)</sup>	Backing Shoulder Dia. D <sub>a</sub>	Backing Shoulder Dia. D <sub>b</sub>	A <sub>a</sub> <sup>(6)</sup>	A <sub>b</sub> <sup>(7)</sup>				
mm in.	mm in.	mm in.	mm in.	mm in.	mm in.	mm in.	mm in.	mm in.	mm in.	mm in.				kg lbs.
19.355 0.7620	15.080 0.5937	-5.8 -0.23	1.3 0.05	32.0 1.26	34.0 1.34	1.3 0.05	54.0 2.13	52.0 2.05	0.7 0.03	1.2 0.05	12.5	6.3	0.0565	0.26 0.56
23.114 0.9100	18.288 0.7200	-5.1 -0.20	0.8 0.03	32.5 1.27	36.0 1.42	1.5 0.06	56.0 2.20	49.5 1.95	1.3 0.05	1.7 0.07	12.7	7.6	0.0670	0.33 0.71
17.462 0.6875	15.875 0.6250	-5.1 -0.20	1.3 0.05	30.5 1.20	32.5 1.28	1.5 0.06	54.0 2.13	51.0 2.01	0.5 0.02	1.9 0.08	12.7	10.3	0.0577	0.27 0.60
19.355 0.7620	15.875 0.6250	-5.8 -0.23	1.3 0.05	32.0 1.26	34.0 1.34	1.3 0.05	55.0 2.17	52.0 2.05	0.7 0.03	1.2 0.05	12.5	6.3	0.0565	0.28 0.61
19.355 0.7620	15.875 0.6250	-5.8 -0.23	3.5 0.14	30.5 1.20	37.0 1.46	1.3 0.05	55.0 2.17	52.0 2.05	0.7 0.03	1.2 0.05	12.5	6.3	0.0565	0.27 0.60
19.050 0.7500	14.288 0.5625	-4.8 -0.19	1.3 0.05	32.5 1.28	33.5 1.32	1.3 0.05	58.0 2.28	55.0 2.17	0.3 0.01	1.8 0.07	14.6	10.0	0.0606	0.29 0.63
20.638 0.8125	14.288 0.5625	-5.8 -0.23	0.8 0.03	31.5 1.24	32.5 1.28	1.3 0.05	58.0 2.28	55.0 2.17	1.2 0.04	1.1 0.05	14.6	10.0	0.0606	0.30 0.65
20.638 0.8125	14.288 0.5625	-5.8 -0.23	3.5 0.14	31.5 1.24	38.0 1.50	1.3 0.05	58.0 2.28	55.0 2.17	1.2 0.04	1.1 0.05	14.6	10.0	0.0606	0.29 0.65
20.638 0.8125	14.288 0.5625	-5.8 -0.23	1.5 0.06	31.5 1.24	34.0 1.34	1.3 0.05	58.0 2.28	55.0 2.17	1.2 0.04	1.1 0.05	14.6	10.0	0.0606	0.30 0.65
20.638 0.8125	15.875 0.6250	-5.8 -0.23	3.5 0.14	31.5 1.24	38.0 1.50	1.3 0.05	58.0 2.28	55.0 2.17	1.2 0.04	1.1 0.05	14.6	10.0	0.0606	0.30 0.67
20.638 0.8125	15.875 0.6250	-5.8 -0.23	0.8 0.03	31.5 1.24	32.5 1.28	1.3 0.05	58.0 2.28	55.0 2.17	1.2 0.04	1.1 0.05	14.6	10.0	0.0606	0.31 0.68
25.433 1.0013	19.050 0.7500	-9.4 -0.37	1.3 0.05	31.5 1.24	33.5 1.32	0.8 0.03	59.0 2.32	57.0 2.24	0.7 0.03	0.8 0.04	19.3	8.0	0.0598	0.38 0.86
20.638 0.8125	15.875 0.6250	-5.8 -0.23	3.5 0.14	31.5 1.24	38.0 1.50	1.3 0.05	59.0 2.32	56.0 2.20	1.2 0.04	1.1 0.05	14.6	10.0	0.0606	0.32 0.72
20.638 0.8125	15.875 0.6250	-5.8 -0.23	0.8 0.03	31.5 1.24	32.5 1.28	1.3 0.05	59.0 2.32	56.0 2.20	1.2 0.04	1.1 0.05	14.6	10.0	0.0606	0.33 0.72
20.638 0.8125	15.875 0.6250	-5.8 -0.23	0.8 0.03	31.5 1.24	32.5 1.28	1.5 0.06	59.0 2.32	55.0 2.17	1.2 0.04	1.1 0.05	14.6	10.0	0.0606	0.33 0.72
20.638 0.8125	15.875 0.6250	-5.8 -0.23	1.5 0.06	31.5 1.24	34.0 1.34	1.3 0.05	59.0 2.32	56.0 2.20	1.2 0.04	1.1 0.05	14.6	10.0	0.0606	0.33 0.72
20.650 0.8130	14.681 0.5780	-1.3 -0.05	2.3 0.09	34.6 1.36	40.5 1.59	2.3 0.09	60.0 2.36	52.0 2.05	2.6 0.10	1.8 0.07	11.3	6.6	0.0700	0.31 0.70

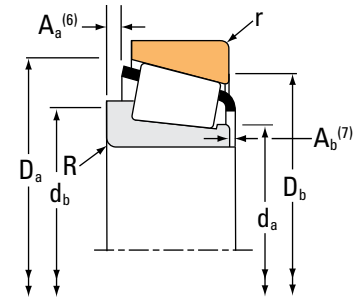
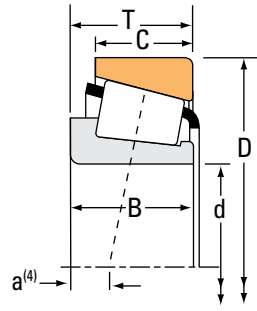
<sup>(4)</sup>Negative value indicates effective center inside cone (inner-ring) backface.  
<sup>(5)</sup>These maximum fillet radii will be cleared by the bearing corners.  
<sup>(6)</sup>Negative value indicates cage extends beyond cone (inner-ring) backface.  
<sup>(7)</sup>Negative value indicates cage that does not extend beyond cone (inner-ring) front face.

Continued on next page.

# TAPERED ROLLER BEARINGS

## SINGLE-ROW • TYPE TS

### TYPE TS



Bearing Dimensions			Load Ratings					Part Number				
Bore d	O.D. D	Width T	Dynamic <sup>(1)</sup>		Factors <sup>(2)</sup>		Dynamic <sup>(3)</sup>		Static		Inner	Outer
			C <sub>1</sub>	e	Y	C <sub>90</sub>	C <sub>a90</sub>	K	C <sub>0</sub>			
mm in.	mm in.	mm in.	N lbf			N lbf	N lbf		N lbf			
25.400 1.0000	63.500 2.5000	20.638 0.8125	59900 13500	0.35	1.71	15500 3490	9310 2090	1.67	53900 12100		15100-S	15250X
25.400 1.0000	65.088 2.5625	22.225 0.8750	54600 12300	0.73	0.82	14200 3180	17700 3990	0.80	55800 12500		23100	23256
25.400 1.0000	66.421 2.6150	23.812 0.9375	76600 17200	0.25	2.36	19900 4470	8640 1940	2.30	81700 18400		2687	2631
25.400 1.0000	68.262 2.6875	22.225 0.8750	67600 15200	0.34	1.77	17500 3940	10200 2290	1.72	73300 16500		2473	2420
25.400 1.0000	68.262 2.6875	22.225 0.8750	63800 14300	0.42	1.44	16500 3720	11800 2650	1.40	70200 15800		02473	02420
25.400 1.0000	68.262 2.6875	22.225 0.8750	59600 13400	0.55	1.10	15500 3470	14400 3250	1.07	77400 17400		M88036	M88010
25.400 1.0000	69.723 2.7450	19.050 0.7500	58800 13200	0.36	1.67	15200 3420	9390 2110	1.62	60100 13500		26100	26274
25.400 1.0000	72.233 2.8438	25.400 1.0000	76800 17300	0.55	1.10	19900 4480	18600 4180	1.07	94200 21200		HM88630	HM88610A
25.400 1.0000	72.233 2.8438	25.400 1.0000	76800 17300	0.55	1.10	19900 4480	18600 4180	1.07	94200 21200		HM88630	HM88610
25.400 1.0000	72.625 2.8593	24.608 0.9688	82600 18600	0.60	1.00	21400 4820	22100 4960	0.97	64100 14400		41100	41286
25.400 1.0000	72.625 2.8593	30.162 1.1875	94800 21300	0.33	1.80	24600 5520	14000 3140	1.76	102000 22800		3189	3120
25.400 1.0000	73.025 2.8750	26.543 1.0450	76800 17300	0.55	1.10	19900 4480	18600 4180	1.07	94200 21200		HM88630	HM88612
25.987 1.0231	51.986 2.0467	15.011 0.5910	35600 8010	0.37	1.60	9230 2080	5910 1330	1.56	32900 7400		L44645	L44613
25.987 1.0231	57.150 2.2500	17.462 0.6875	46000 10300	0.35	1.73	11900 2680	7070 1590	1.69	50100 11300		15579X	15520
26.157 1.0298	61.912 2.4375	19.050 0.7500	59900 13500	0.35	1.71	15500 3490	9310 2090	1.67	53900 12100		15103	15243
26.157 1.0298	62.000 2.4409	19.050 0.7500	59900 13500	0.35	1.71	15500 3490	9310 2090	1.67	53900 12100		15103	15245
26.162 1.0300	61.912 2.4375	19.050 0.7500	59900 13500	0.35	1.71	15500 3490	9310 2090	1.67	53900 12100		15103-S	15243

<sup>(1)</sup>Based on 1 x 10<sup>6</sup> revolutions L<sub>10</sub> life, for the ISO life-calculation method.

<sup>(2)</sup>Consult your Timken engineer for instructions on use or review the Timken Engineering Manual on timken.com/catalogs.

<sup>(3)</sup>Based on 90 x 10<sup>6</sup> revolutions L<sub>10</sub> life, for The Timken Company life-calculation method. C<sub>90</sub> and C<sub>a90</sub> are radial and thrust values.

Bearing Dimensions											Geometry Factors			Bearing Weight
Width B	Width C	Eff. Ctr. a <sup>(4)</sup>	Shaft			Housing			Cage		G <sub>1</sub>	G <sub>2</sub>	C <sub>g</sub>	
			Max Shaft Fillet Radius R <sup>(5)</sup>	Backing Shoulder Dia. d <sub>a</sub>	Shoulder Dia. d <sub>b</sub>	Max Housing Fillet Radius r <sup>(5)</sup>	Backing Shoulder Dia. D <sub>a</sub>	Shoulder Dia. D <sub>b</sub>	A <sub>a</sub> <sup>(6)</sup>	A <sub>b</sub> <sup>(7)</sup>				
mm in.	mm in.	mm in.	mm in.	mm in.	mm in.	mm in.	mm in.	mm in.	mm in.	mm in.				kg lbs.
20.638 0.8125	15.875 0.6250	-5.8 -0.23	1.3 0.05	31.5 1.24	33.5 1.32	1.5 0.06	59.0 2.32	55.0 2.17	1.2 0.04	1.1 0.05	14.6	10.0	0.0606	0.33 0.72
21.463 0.8450	15.875 0.6250	-2.3 -0.09	1.5 0.06	34.5 1.36	39.0 1.54	1.5 0.06	63.0 2.48	53.0 2.09	3.7 0.14	2.1 0.08	11.3	6.6	0.0700	0.35 0.79
25.433 1.0013	19.050 0.7500	-9.4 -0.37	1.3 0.05	31.5 1.24	33.5 1.32	1.3 0.05	60.0 2.36	58.0 2.28	0.7 0.03	0.8 0.04	19.3	8.0	0.0598	0.43 0.97
23.812 0.9375	17.462 0.6875	-6.6 -0.26	0.8 0.03	32.5 1.28	33.5 1.32	1.5 0.06	63.0 2.48	60.0 2.36	0.9 0.03	0.3 0.01	18.8	10.5	0.0652	0.44 0.96
22.225 0.8750	17.462 0.6875	-5.1 -0.20	0.8 0.03	33.5 1.32	34.5 1.36	1.5 0.06	63.0 2.48	59.0 2.32	1.1 0.04	0.9 0.04	17.5	8.5	0.0681	0.43 0.94
22.225 0.8750	17.462 0.6875	-2.8 -0.11	0.8 0.03	36.5 1.44	37.0 1.46	1.5 0.06	65.0 2.56	58.0 2.28	1.7 0.06	1.0 0.04	19.4	10.0	0.0771	0.44 0.97
18.923 0.7450	19.050 0.7500	-4.1 -0.16	1.5 0.06	32.5 1.28	34.5 1.36	1.5 0.06	64.9 2.56	61.0 2.40	0.5 0.02	1.1 0.05	16.1	10.1	0.0630	0.39 0.88
25.400 1.0000	19.842 0.7812	-4.6 -0.18	0.8 0.03	39.5 1.56	39.5 1.56	0.8 0.03	69.0 2.72	61.0 2.40	1.6 0.06	1.7 0.07	23.4	9.4	0.0822	0.58 1.29
25.400 1.0000	19.842 0.7812	-4.6 -0.18	0.8 0.03	39.5 1.56	39.5 1.56	2.3 0.09	69.0 2.72	60.0 2.36	1.6 0.06	1.7 0.07	23.4	9.4	0.0822	0.57 1.28
24.257 0.9550	17.462 0.6875	-4.1 -0.16	2.3 0.09	36.5 1.44	41.0 1.61	1.5 0.06	68.0 2.68	61.0 2.40	3.0 0.12	2.3 0.09	13.0	5.8	0.0686	0.50 1.09
29.997 1.1810	23.812 0.9375	-10.2 -0.40	0.8 0.03	35.0 1.38	35.5 1.40	3.3 0.13	67.0 2.64	61.0 2.40	* *	* *	23.4	8.8	0.0697	0.66 1.43
25.400 1.0000	20.985 0.8262	-4.6 -0.18	0.8 0.03	39.5 1.56	39.5 1.56	2.3 0.09	69.0 2.72	60.0 2.36	1.6 0.06	1.7 0.07	23.4	9.4	0.0822	0.61 1.35
14.732 0.5800	12.700 0.5000	-3.3 -0.13	3.5 0.14	30.0 1.18	36.5 1.44	2.0 0.08	48.0 1.89	44.5 1.75	0.8 0.03	0.6 0.03	8.9	8.9	0.0526	0.14 0.30
17.462 0.6875	13.495 0.5313	-5.1 -0.20	3.5 0.14	31.0 1.22	37.5 1.48	1.5 0.06	53.0 2.09	51.0 2.01	* *	* *	12.7	10.3	0.0577	0.21 0.46
20.638 0.8125	14.288 0.5625	-5.8 -0.23	0.8 0.03	32.5 1.28	33.0 1.30	2.0 0.08	58.0 2.28	54.0 2.13	1.2 0.04	1.1 0.05	14.6	10.0	0.0606	0.29 0.64
20.638 0.8125	14.288 0.5625	-5.8 -0.23	0.8 0.03	32.5 1.28	33.0 1.30	1.3 0.05	58.0 2.28	55.0 2.17	1.2 0.04	1.1 0.05	14.6	10.0	0.0606	0.29 0.64
19.939 0.7850	14.288 0.5625	-5.8 -0.23	0.8 0.03	33.5 1.32	33.5 1.32	2.0 0.08	58.0 2.28	54.0 2.13	1.2 0.04	1.7 0.07	14.6	10.0	0.0606	0.29 0.64

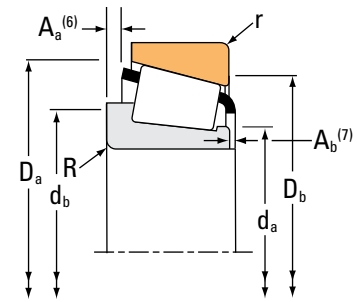
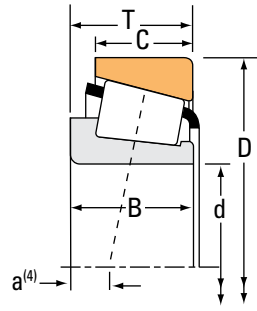
(4) Negative value indicates effective center inside cone (inner-ring) backface.  
 (5) These maximum fillet radii will be cleared by the bearing corners.  
 (6) Negative value indicates cage extends beyond cone (inner-ring) backface.  
 (7) Negative value indicates cage that does not extend beyond cone (inner-ring) front face.  
 (\*) Contact your Timken engineer for details.

Continued on next page.

# TAPERED ROLLER BEARINGS

## SINGLE-ROW • TYPE TS

### TYPE TS



Bearing Dimensions			Load Ratings						Part Number				
Bore d	O.D. D	Width T	Dynamic <sup>(1)</sup>		Factors <sup>(2)</sup>		Dynamic <sup>(3)</sup>		Factors <sup>(2)</sup>		Static C <sub>0</sub>	Inner	Outer
			C <sub>1</sub>	e	Y	C <sub>90</sub>	C <sub>a90</sub>	K	N	N			
mm in.	mm in.	mm in.	N lbf			N lbf	N lbf		N lbf				
26.162 1.0300	66.421 2.6150	23.812 0.9375	76600 17200	0.25	2.36	19900 4470	8640 1940	2.30	81700 18400		2682	2631	
26.975 1.0620	58.738 2.3125	19.050 0.7500	48400 10900	0.33	1.82	12500 2820	7080 1590	1.77	50200 11300		1987	1932	
26.975 1.0620	60.325 2.3750	19.355 0.7620	48400 10900	0.33	1.82	12500 2820	7080 1590	1.77	50200 11300		1987	1931	
26.987 1.0625	50.292 1.9800	14.224 0.5600	35600 8010	0.37	1.60	9230 2080	5910 1330	1.56	32900 7400		L44649	L44610	
26.987 1.0625	51.986 2.0467	15.011 0.5910	35600 8010	0.37	1.60	9230 2080	5910 1330	1.56	32900 7400		L44649	L44613	
26.987 1.0625	57.150 2.2500	17.462 0.6875	46000 10300	0.35	1.73	11900 2680	7070 1590	1.69	50100 11300		15580	15520	
26.987 1.0625	57.150 2.2500	19.431 0.7650	48500 10900	0.55	1.10	12600 2830	11800 2640	1.07	52900 11900		M84549	M84510	
26.987 1.0625	57.150 2.2500	19.845 0.7813	48400 10900	0.33	1.82	12500 2820	7080 1590	1.77	50200 11300		1997X	1922	
26.987 1.0625	60.325 2.3750	19.842 0.7812	46000 10300	0.35	1.73	11900 2680	7070 1590	1.69	50100 11300		15580	15523	
26.987 1.0625	62.000 2.4409	19.050 0.7500	59900 13500	0.35	1.71	15500 3490	9310 2090	1.67	53900 12100		15106	15245	
26.987 1.0625	63.500 2.5000	20.638 0.8125	59900 13500	0.35	1.71	15500 3490	9310 2090	1.67	53900 12100		15106	15250X	
26.987 1.0625	66.421 2.6150	23.812 0.9375	76600 17200	0.25	2.36	19900 4470	8640 1940	2.30	81700 18400		2688	2631	
26.987 1.0625	72.625 2.8593	24.608 0.9688	82600 18600	0.60	1.00	21400 4820	22100 4960	0.97	64100 14400		41106	41286	
27.000 1.0630	59.131 2.3280	15.875 0.6250	46700 10500	0.41	1.46	12100 2720	8550 1920	1.42	44600 10000		JLM67042	LM67010	
27.987 1.1019	66.987 2.6373	20.500 0.8071	63800 14300	0.42	1.44	16500 3720	11800 2650	1.40	70200 15800		02473X	02419	
28.000 1.1024	57.150 2.2500	17.462 0.6875	54500 12300	0.35	1.73	14100 3180	8380 1880	1.69	50100 11300		J15585	15520	
28.575 1.1250	56.896 2.2400	19.845 0.7813	48400 10900	0.33	1.82	12500 2820	7080 1590	1.77	50200 11300		1985	1930	

<sup>(1)</sup>Based on 1 x 10<sup>6</sup> revolutions L<sub>10</sub> life, for the ISO life-calculation method.

<sup>(2)</sup>Consult your Timken engineer for instructions on use or review the Timken Engineering Manual on timken.com/catalogs.

<sup>(3)</sup>Based on 90 x 10<sup>6</sup> revolutions L<sub>10</sub> life, for The Timken Company life-calculation method. C<sub>90</sub> and C<sub>a90</sub> are radial and thrust values.

Bearing Dimensions											Geometry Factors			Bearing Weight
Width B	Width C	Eff. Ctr. a <sup>(4)</sup>	Shaft			Housing			Cage		G <sub>1</sub>	G <sub>2</sub>	C <sub>g</sub>	
			Max Shaft Fillet Radius R <sup>(5)</sup>	Backing Shoulder Dia. d <sub>a</sub>	Backing Shoulder Dia. d <sub>b</sub>	Max Housing Fillet Radius r <sup>(5)</sup>	Backing Shoulder Dia. D <sub>a</sub>	Backing Shoulder Dia. D <sub>b</sub>	A <sub>a</sub> <sup>(6)</sup>	A <sub>b</sub> <sup>(7)</sup>				
mm in.	mm in.	mm in.	mm in.	mm in.	mm in.	mm in.	mm in.	mm in.	mm in.	mm in.				kg lbs.
25.433 1.0013	19.050 0.7500	-9.4 -0.37	1.5 0.06	32.0 1.26	34.5 1.36	1.3 0.05	60.0 2.36	58.0 2.28	0.7 0.03	0.8 0.04	19.3	8.0	0.0598	0.43 0.95
19.355 0.7620	15.080 0.5937	-5.8 -0.23	0.8 0.03	31.5 1.24	32.5 1.28	1.3 0.05	54.0 2.13	52.0 2.05	0.7 0.03	1.2 0.05	12.5	6.3	0.0565	0.25 0.54
19.355 0.7620	15.875 0.6250	-5.8 -0.23	0.8 0.03	31.5 1.24	32.5 1.28	1.3 0.05	55.0 2.17	52.0 2.05	0.7 0.03	1.2 0.05	12.5	6.3	0.0565	0.27 0.59
14.732 0.5800	10.668 0.4200	-3.3 -0.13	3.5 0.14	31.0 1.22	37.5 1.48	1.3 0.05	47.0 1.85	44.5 1.75	0.7 0.03	0.6 0.03	8.9	8.9	0.0526	0.12 0.26
14.732 0.5800	12.700 0.5000	-3.3 -0.13	3.5 0.14	31.0 1.22	37.5 1.48	2.0 0.08	48.0 1.89	44.5 1.75	0.7 0.03	0.6 0.03	8.9	8.9	0.0526	0.14 0.30
17.462 0.6875	13.495 0.5313	-5.1 -0.20	3.5 0.14	32.0 1.26	38.5 1.52	1.5 0.06	53.0 2.09	51.0 2.01	0.5 0.02	1.9 0.08	12.7	10.3	0.0577	0.21 0.45
19.431 0.7650	14.732 0.5800	-3.0 -0.12	1.5 0.06	33.0 1.30	38.5 1.52	1.5 0.06	54.0 2.13	48.5 1.91	1.1 0.04	1.3 0.05	11.3	7.4	0.0644	0.24 0.51
19.355 0.7620	15.875 0.6250	-5.8 -0.23	3.3 0.13	31.5 1.24	37.5 1.48	1.5 0.06	53.5 2.11	51.0 2.01	0.7 0.03	1.2 0.05	12.5	6.3	0.0565	0.23 0.50
17.462 0.6875	15.875 0.6250	-5.1 -0.20	3.5 0.14	32.0 1.26	38.5 1.52	1.5 0.06	54.0 2.13	51.0 2.01	0.5 0.02	1.9 0.08	12.7	10.3	0.0577	0.26 0.57
20.638 0.8125	14.288 0.5625	-5.8 -0.23	0.8 0.03	33.0 1.30	33.5 1.32	1.3 0.05	58.0 2.28	55.0 2.17	1.2 0.04	1.1 0.05	14.6	10.0	0.0606	0.29 0.63
20.638 0.8125	15.875 0.6250	-5.8 -0.23	0.8 0.03	33.0 1.30	33.5 1.32	1.5 0.06	59.0 2.32	55.0 2.17	1.2 0.04	1.1 0.05	14.6	10.0	0.0606	0.32 0.70
25.433 1.0013	19.050 0.7500	-9.4 -0.37	1.5 0.06	33.0 1.30	35.0 1.38	1.3 0.05	60.0 2.36	58.0 2.28	0.7 0.03	0.8 0.04	19.3	8.0	0.0598	0.42 0.94
24.257 0.9550	17.462 0.6875	-4.1 -0.16	2.3 0.09	36.5 1.44	42.0 1.65	1.5 0.06	68.0 2.68	61.0 2.40	3.0 0.12	2.3 0.09	13.0	5.8	0.0686	0.49 1.07
16.764 0.6600	11.811 0.4650	-3.0 -0.12	0.5 0.02	33.0 1.30	33.5 1.32	1.3 0.05	56.0 2.20	52.0 2.05	0.7 0.02	0.8 0.03	12.8	9.7	0.0612	0.21 0.47
20.500 0.8071	16.000 0.6299	-5.1 -0.20	0.8 0.03	35.5 1.40	36.5 1.44	1.5 0.06	62.0 2.44	59.0 2.32	1.1 0.04	2.7 0.11	17.5	8.5	0.0681	0.36 0.80
17.462 0.6875	13.495 0.5313	-5.1 -0.20	3.5 0.14	32.5 1.28	39.0 1.54	1.5 0.06	53.0 2.09	51.0 2.01	* *	* *	12.7	10.3	0.0577	0.20 0.44
19.355 0.7620	15.875 0.6250	-5.8 -0.23	0.8 0.03	33.5 1.32	34.0 1.34	0.8 0.03	54.0 2.11	51.0 2.01	0.7 0.03	1.2 0.05	12.5	6.3	0.0565	0.22 0.48

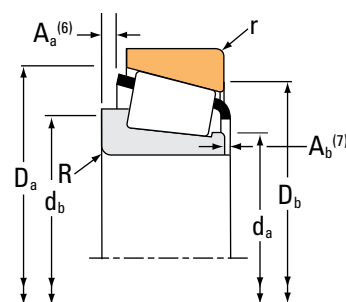
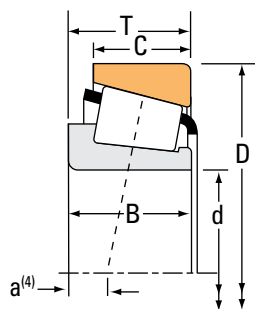
(4) Negative value indicates effective center inside cone (inner-ring) backface.  
 (5) These maximum fillet radii will be cleared by the bearing corners.  
 (6) Negative value indicates cage extends beyond cone (inner-ring) backface.  
 (7) Negative value indicates cage that does not extend beyond cone (inner-ring) front face.  
 (\*) Contact your Timken engineer for details.

Continued on next page.

# TAPERED ROLLER BEARINGS

## SINGLE-ROW • TYPE TS

### TYPE TS



Bearing Dimensions			Load Ratings						Part Number			
Bore d	O.D. D	Width T	Dynamic <sup>(1)</sup>		Factors <sup>(2)</sup>		Dynamic <sup>(3)</sup>		Static		Inner	Outer
			C <sub>1</sub>	e	Y	C <sub>90</sub>	C <sub>a90</sub>	K	C <sub>0</sub>			
mm in.	mm in.	mm in.	N lbf			N lbf	N lbf		N lbf			
28.575 1.1250	57.150 2.2500	17.462 0.6875	46000 10300	0.35	1.73	11900 2680	7070 1590	1.69	50100 11300		15590	15520
28.575 1.1250	57.150 2.2500	19.845 0.7813	48400 10900	0.33	1.82	12500 2820	7080 1590	1.77	50200 11300		1985	1922
28.575 1.1250	58.738 2.3125	19.050 0.7500	48400 10900	0.33	1.82	12500 2820	7080 1590	1.77	50200 11300		1985	1932
28.575 1.1250	59.131 2.3280	15.875 0.6250	36500 8210	0.41	1.46	9460 2130	6680 1500	1.42	44600 10000	LM67043		LM67010
28.575 1.1250	60.325 2.3750	19.845 0.7813	48400 10900	0.33	1.82	12500 2820	7080 1590	1.77	50200 11300		1985	1931
28.575 1.1250	62.000 2.4409	19.050 0.7500	59900 13500	0.35	1.71	15500 3490	9310 2090	1.67	53900 12100		15113	15245
28.575 1.1250	62.000 2.4409	19.050 0.7500	59900 13500	0.35	1.71	15500 3490	9310 2090	1.67	53900 12100		15112	15245
28.575 1.1250	62.000 2.4409	20.638 0.8125	59900 13500	0.35	1.71	15500 3490	9310 2090	1.67	53900 12100		15112	15244
28.575 1.1250	63.100 2.4843	23.812 0.9375	76600 17200	0.25	2.36	19900 4470	8640 1940	2.30	81700 18400		2689	2630
28.575 1.1250	63.500 2.5000	20.638 0.8125	59900 13500	0.35	1.71	15500 3490	9310 2090	1.67	53900 12100		15112	15250
28.575 1.1250	63.500 2.5000	20.638 0.8125	59900 13500	0.35	1.71	15500 3490	9310 2090	1.67	53900 12100		15113	15250
28.575 1.1250	63.500 2.5000	20.638 0.8125	59900 13500	0.35	1.71	15500 3490	9310 2090	1.67	53900 12100		15112	15250X
28.575 1.1250	64.292 2.5312	21.433 0.8438	60200 13500	0.55	1.10	15600 3510	14600 3280	1.07	71700 16100	M86647		M86610
28.575 1.1250	66.421 2.6150	19.050 0.7500	55900 12600	0.34	1.77	14500 3260	8420 1890	1.72	55200 12400		24112	24261
28.575 1.1250	66.421 2.6150	23.812 0.9375	76600 17200	0.25	2.36	19900 4470	8640 1940	2.30	81700 18400		2689	2631
28.575 1.1250	68.262 2.6875	22.225 0.8750	67600 15200	0.34	1.77	17500 3940	10200 2290	1.72	73300 16500		2474	2420
28.575 1.1250	68.262 2.6875	22.225 0.8750	63800 14300	0.42	1.44	16500 3720	11800 2650	1.40	70200 15800		02474	02420

<sup>(1)</sup>Based on 1 x 10<sup>6</sup> revolutions L<sub>10</sub> life, for the ISO life-calculation method.

<sup>(2)</sup>Consult your Timken engineer for instructions on use or review the Timken Engineering Manual on timken.com/catalogs.

<sup>(3)</sup>Based on 90 x 10<sup>6</sup> revolutions L<sub>10</sub> life, for The Timken Company life-calculation method. C<sub>90</sub> and C<sub>a90</sub> are radial and thrust values.



Bearing Dimensions											Geometry Factors			Bearing Weight
Width B	Width C	Eff. Ctr. a <sup>(4)</sup>	Shaft			Housing			Cage		G <sub>1</sub>	G <sub>2</sub>	C <sub>g</sub>	
			Max Shaft Fillet Radius R <sup>(5)</sup>	Backing Shoulder Dia. d <sub>a</sub> d <sub>b</sub>		Max Housing Fillet Radius r <sup>(5)</sup>	Backing Shoulder Dia. D <sub>a</sub> D <sub>b</sub>		A <sub>a</sub> <sup>(6)</sup>	A <sub>b</sub> <sup>(7)</sup>				
mm in.	mm in.	mm in.	mm in.	mm in.	mm in.	mm in.	mm in.	mm in.	mm in.	mm in.				kg lbs.
17.462 0.6875	13.495 0.5313	-5.1 -0.20	3.5 0.14	33.5 1.32	39.5 1.56	1.5 0.06	53.0 2.09	51.0 2.01	0.5 0.02	1.9 0.08	12.7	10.3	0.0577	0.20 0.43
19.355 0.7620	15.875 0.6250	-5.8 -0.23	0.8 0.03	33.5 1.32	34.0 1.34	1.5 0.06	53.5 2.11	51.0 2.01	0.7 0.03	1.2 0.05	12.5	6.3	0.0565	0.23 0.49
19.355 0.7620	15.080 0.5937	-5.8 -0.23	0.8 0.03	33.5 1.32	34.0 1.34	1.3 0.05	54.0 2.13	52.0 2.05	0.7 0.03	1.2 0.05	12.5	6.3	0.0565	0.24 0.51
16.764 0.6600	11.811 0.4650	-3.0 -0.12	0.0 0.00	35.0 1.38	41.5 1.63	1.3 0.05	56.0 2.20	52.0 2.05	0.7 0.02	0.8 0.03	12.8	9.7	0.0612	0.20 0.44
19.355 0.7620	15.875 0.6250	-5.8 -0.23	0.8 0.03	33.5 1.32	34.0 1.34	1.3 0.05	55.0 2.17	52.0 2.05	0.7 0.03	1.2 0.05	12.5	6.3	0.0565	0.26 0.57
20.638 0.8125	14.288 0.5625	-5.8 -0.23	0.8 0.03	34.0 1.34	34.5 1.36	1.3 0.05	58.0 2.28	55.0 2.17	1.2 0.04	1.1 0.05	14.6	10.0	0.0606	0.28 0.61
20.638 0.8125	14.288 0.5625	-5.8 -0.23	3.5 0.14	34.0 1.34	40.0 1.57	1.3 0.05	58.0 2.28	55.0 2.17	1.2 0.04	1.1 0.05	14.6	10.0	0.0606	0.27 0.60
20.638 0.8125	15.875 0.6250	-5.8 -0.23	3.5 0.14	34.0 1.34	40.0 1.57	1.3 0.05	58.0 2.28	55.0 2.17	1.2 0.04	1.1 0.05	14.6	10.0	0.0606	0.28 0.62
25.433 1.0013	19.050 0.7500	-9.4 -0.37	1.3 0.05	36.0 1.42	37.5 1.48	0.8 0.03	59.0 2.32	57.0 2.24	0.7 0.03	0.8 0.04	19.3	8.0	0.0598	0.36 0.80
20.638 0.8125	15.875 0.6250	-5.8 -0.23	3.5 0.14	34.0 1.34	40.0 1.57	1.3 0.05	59.0 2.32	56.0 2.20	1.2 0.04	1.1 0.05	14.6	10.0	0.0606	0.30 0.67
20.638 0.8125	15.875 0.6250	-5.8 -0.23	0.8 0.03	34.0 1.34	34.5 1.36	1.3 0.05	59.0 2.32	56.0 2.20	1.2 0.04	1.1 0.05	14.6	10.0	0.0606	0.31 0.68
20.638 0.8125	15.875 0.6250	-5.8 -0.23	3.5 0.14	34.0 1.34	40.0 1.57	1.5 0.06	59.0 2.32	55.0 2.17	1.2 0.04	1.1 0.05	14.6	10.0	0.0606	0.30 0.67
21.433 0.8438	16.670 0.6563	-3.3 -0.13	1.5 0.06	31.0 1.50	40.0 1.57	1.5 0.06	60.0 2.36	54.0 2.13	1.3 0.05	1.3 0.05	16.8	7.4	0.0736	0.35 0.77
18.974 0.7470	15.875 0.6250	-4.8 -0.19	1.5 0.06	34.0 1.34	36.0 1.42	1.5 0.06	61.0 2.40	58.0 2.28	0.3 0.01	1.5 0.06	14.0	8.3	0.0589	0.31 0.69
25.433 1.0013	19.050 0.7500	-9.4 -0.37	1.3 0.05	36.0 1.42	37.5 1.48	1.3 0.05	60.0 2.36	58.0 2.28	0.7 0.03	0.8 0.04	19.3	8.0	0.0598	0.41 0.91
23.812 0.9375	17.462 0.6875	-6.6 -0.26	0.8 0.03	35.0 1.38	36.0 1.42	1.5 0.06	63.0 2.48	60.0 2.36	0.9 0.03	0.3 0.01	18.8	10.5	0.0652	0.42 0.90
22.225 0.8750	17.462 0.6875	-5.1 -0.20	0.8 0.03	36.0 1.42	36.5 1.44	1.5 0.06	63.0 2.48	59.0 2.32	1.1 0.04	0.9 0.04	17.5	8.5	0.0681	0.41 0.89

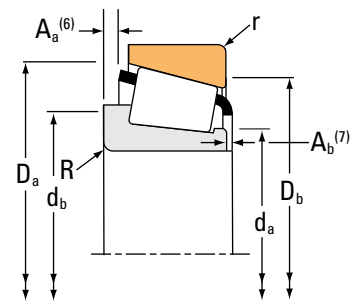
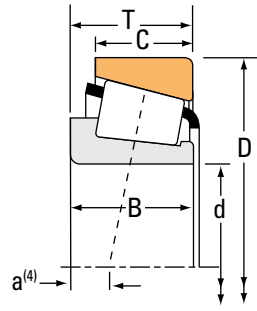
<sup>(4)</sup>Negative value indicates effective center inside cone (inner-ring) backface.  
<sup>(5)</sup>These maximum fillet radii will be cleared by the bearing corners.  
<sup>(6)</sup>Negative value indicates cage extends beyond cone (inner-ring) backface.  
<sup>(7)</sup>Negative value indicates cage that does not extend beyond cone (inner-ring) front face.

Continued on next page.

# TAPERED ROLLER BEARINGS

## SINGLE-ROW • TYPE TS

### TYPE TS



Bearing Dimensions			Load Ratings						Part Number				
Bore d	O.D. D	Width T	Dynamic <sup>(1)</sup>		Factors <sup>(2)</sup>		Dynamic <sup>(3)</sup>		Factors <sup>(2)</sup>		Static C <sub>0</sub>	Inner	Outer
			C <sub>1</sub>	e	Y	C <sub>90</sub>	C <sub>a90</sub>	K	N	N			
mm in.	mm in.	mm in.	N lbf			N lbf	N lbf		N lbf				
28.575 1.1250	69.723 2.7450	19.050 0.7500	69600 15700	0.36	1.67	18100 4060	11100 2500	1.62	60100 13500		26112	26274	
28.575 1.1250	69.850 2.7500	23.812 0.9375	83700 18800	0.27	2.19	21700 4880	10200 2280	2.14	94400 21200		2578	2523	
28.575 1.1250	69.850 2.7500	23.812 0.9375	83700 18800	0.27	2.19	21700 4880	10200 2280	2.14	94400 21200		2578	2523-S	
28.575 1.1250	72.000 2.8346	19.000 0.7480	69600 15700	0.36	1.67	18100 4060	11100 2500	1.62	60100 13500		26112	26283	
28.575 1.1250	72.625 2.8593	24.608 0.9688	82600 18600	0.60	1.00	21400 4820	22100 4960	0.97	64100 14400		41125	41286	
28.575 1.1250	72.625 2.8593	24.608 0.9688	82600 18600	0.60	1.00	21400 4820	22100 4960	0.97	64100 14400		41126	41286	
28.575 1.1250	72.625 2.8593	30.162 1.1875	94800 21300	0.33	1.80	24600 5520	14000 3140	1.76	102000 22800		3192	3120	
28.575 1.1250	72.625 2.8593	30.162 1.1875	94800 21300	0.33	1.80	24600 5520	14000 3140	1.76	102000 22800		3198	3120	
28.575 1.1250	73.025 2.8750	22.225 0.8750	65700 14800	0.45	1.32	17000 3830	13200 2980	1.29	74900 16800		02872	02820	
28.575 1.1250	73.025 2.8750	22.225 0.8750	65700 14800	0.45	1.32	17000 3830	13200 2980	1.29	74900 16800		02872	02830	
28.575 1.1250	76.200 3.0000	19.000 0.7480	69600 15700	0.36	1.67	18100 4060	11100 2500	1.62	60100 13500		26112	26300	
28.575 1.1250	76.200 3.0000	30.162 1.1875	94800 21300	0.33	1.80	24600 5520	14000 3140	1.76	102000 22800		3198	3129	
28.575 1.1250	79.375 3.1250	25.400 1.0000	92000 20700	0.67	0.90	23900 5360	27300 6130	0.87	76200 17100		43112	43312	
29.000 1.1417	50.292 1.9800	14.224 0.5600	35500 7980	0.37	1.62	9200 2070	5820 1310	1.58	36200 8130		L45449	L45410	
29.367 1.1562	66.421 2.6150	23.812 0.9375	76600 17200	0.25	2.36	19900 4470	8640 1940	2.30	81700 18400		2691	2631	
29.367 1.1562	66.421 2.6150	23.812 0.9375	76600 17200	0.25	2.36	19900 4470	8640 1940	2.30	81700 18400		2690	2631	
29.987 1.1806	61.981 2.4402	16.002 0.6300	43200 9720	0.38	1.57	11200 2520	7340 1650	1.53	44100 9910		17118	17244A	

<sup>(1)</sup>Based on  $1 \times 10^6$  revolutions  $L_{10}$  life, for the ISO life-calculation method.

<sup>(2)</sup>Consult your Timken engineer for instructions on use or review the Timken Engineering Manual on [timken.com/catalogs](http://timken.com/catalogs).

<sup>(3)</sup>Based on  $90 \times 10^6$  revolutions  $L_{10}$  life, for The Timken Company life-calculation method.  $C_{90}$  and  $C_{a90}$  are radial and thrust values.

Bearing Dimensions											Geometry Factors			Bearing Weight
Width B	Width C	Eff. Ctr. a <sup>(4)</sup>	Shaft			Housing			Cage		G <sub>1</sub>	G <sub>2</sub>	C <sub>g</sub>	
			Max Shaft Fillet Radius R <sup>(5)</sup>	Backing Shoulder Dia. d <sub>a</sub> d <sub>b</sub>		Max Housing Fillet Radius r <sup>(5)</sup>	Backing Shoulder Dia. D <sub>a</sub> D <sub>b</sub>		A <sub>a</sub> <sup>(6)</sup>	A <sub>b</sub> <sup>(7)</sup>				
mm in.	mm in.	mm in.	mm in.	mm in.	mm in.	mm in.	mm in.	mm in.	mm in.	mm in.				kg lbs.
18.923 0.7450	19.050 0.7500	-4.1 -0.16	1.5 0.06	35.0 1.38	37.0 1.46	1.5 0.06	64.9 2.56	61.0 2.40	0.5 0.02	1.1 0.05	16.1	10.1	0.0630	0.37 0.83
25.357 0.9983	19.050 0.7500	-8.6 -0.34	2.3 0.09	35.0 1.38	39.0 1.54	1.3 0.05	64.0 2.52	61.0 2.40	0.8 0.03	0.8 0.04	23.6	9.6	0.0656	0.48 1.06
25.357 0.9983	19.050 0.7500	-8.6 -0.34	2.3 0.09	35.0 1.38	39.0 1.54	1.5 0.06	64.0 2.52	61.0 2.40	0.8 0.03	0.8 0.04	23.6	9.6	0.0656	0.48 1.06
18.923 0.7450	15.875 0.6250	-4.1 -0.16	1.5 0.06	35.0 1.38	37.0 1.46	1.5 0.06	65.0 2.56	62.0 2.44	0.5 0.02	1.1 0.05	16.1	10.1	0.0630	0.39 0.87
24.257 0.9550	17.462 0.6875	-4.1 -0.16	4.8 0.19	36.5 1.44	48.0 1.89	1.5 0.06	68.0 2.68	61.0 2.40	3.0 0.12	2.3 0.09	13.0	5.8	0.0686	0.47 1.02
24.257 0.9550	17.462 0.6875	-4.1 -0.16	1.5 0.06	36.5 1.44	41.5 1.63	1.5 0.06	68.0 2.68	61.0 2.40	3.0 0.12	2.3 0.09	13.0	5.8	0.0686	0.47 1.04
29.997 1.1810	23.812 0.9375	-10.2 -0.40	3.5 0.14	37.0 1.46	43.5 1.71	3.3 0.13	67.0 2.64	61.0 2.40	1.5 0.06	0.6 0.02	23.4	8.8	0.0697	0.62 1.35
29.997 1.1810	23.812 0.9375	-10.2 -0.40	1.3 0.05	37.0 1.46	39.0 1.54	3.3 0.13	67.0 2.64	61.0 2.40	1.5 0.06	0.6 0.02	23.4	8.8	0.0697	0.63 1.36
22.225 0.8750	17.462 0.6875	-3.8 -0.15	0.8 0.03	37.0 1.46	37.5 1.48	3.3 0.13	68.0 2.68	62.0 2.44	1.4 0.05	1.0 0.04	20.6	10.1	0.0740	0.47 1.05
22.225 0.8750	17.462 0.6875	-3.8 -0.15	0.8 0.03	37.0 1.46	37.5 1.48	0.8 0.03	68.0 2.68	64.0 2.52	1.4 0.05	1.0 0.04	20.6	10.1	0.0740	0.48 1.07
18.923 0.7450	15.875 0.6250	-4.1 -0.16	1.5 0.06	35.0 1.38	37.0 1.46	1.5 0.06	66.0 2.60	64.0 2.52	0.5 0.02	1.1 0.05	16.1	10.1	0.0630	0.45 1.00
29.997 1.1810	23.812 0.9375	-10.2 -0.40	1.3 0.05	37.0 1.46	39.0 1.54	0.8 0.03	69.0 2.72	65.0 2.56	1.5 0.06	0.6 0.02	23.4	8.8	0.0697	0.71 1.55
24.074 0.9478	17.462 0.6875	-2.0 -0.08	0.8 0.03	41.5 1.63	42.5 1.67	1.5 0.06	74.0 2.91	67.0 2.64	3.4 0.13	2.4 0.10	16.8	7.6	0.0774	0.62 1.35
14.732 0.5800	10.668 0.4200	-3.3 -0.13	3.5 0.14	33.5 1.32	40.0 1.57	1.3 0.05	48.0 1.89	44.5 1.75	0.5 0.02	0.8 0.04	10.8	12.4	0.0559	0.11 0.25
25.433 1.0013	19.050 0.7500	-9.4 -0.37	0.8 0.03	36.5 1.44	37.5 1.48	1.3 0.05	60.0 2.36	58.0 2.28	0.7 0.03	0.8 0.04	19.3	8.0	0.0598	0.40 0.89
25.433 1.0013	19.050 0.7500	-9.4 -0.37	3.5 0.14	35.0 1.38	41.0 1.61	1.3 0.05	60.0 2.36	58.0 2.28	0.7 0.03	0.8 0.04	19.3	8.0	0.0598	0.39 0.88
16.566 0.6522	14.288 0.5625	-3.6 -0.14	1.5 0.06	36.0 1.42	38.5 1.52	1.5 0.06	57.0 2.24	54.0 2.13	0.2 0.01	1.9 0.08	11.8	7.5	0.0579	0.22 0.50

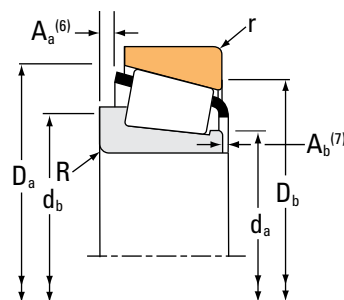
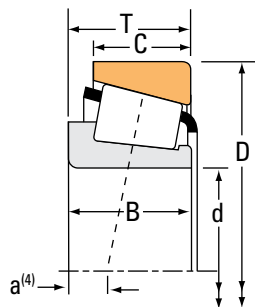
(4) Negative value indicates effective center inside cone (inner-ring) backface.  
 (5) These maximum fillet radii will be cleared by the bearing corners.  
 (6) Negative value indicates cage extends beyond cone (inner-ring) backface.  
 (7) Negative value indicates cage that does not extend beyond cone (inner-ring) front face.

Continued on next page.

# TAPERED ROLLER BEARINGS

## SINGLE-ROW • TYPE TS

### TYPE TS



Bearing Dimensions			Load Ratings					Part Number					
Bore d	O.D. D	Width T	Dynamic <sup>(1)</sup>		Factors <sup>(2)</sup>		Dynamic <sup>(3)</sup>		Factors <sup>(2)</sup>		Static C <sub>0</sub>	Inner	Outer
			C <sub>1</sub>	e	Y	C <sub>90</sub>	C <sub>a90</sub>	K	N	N			
mm in.	mm in.	mm in.	N lbf			N lbf	N lbf		N lbf				
29.987 1.1806	62.000 2.4409	16.002 0.6300	43200 9720	0.38	1.57	11200 2520	7340 1650	1.53	44100 9910		17118	17244	
29.987 1.1806	62.000 2.4409	18.161 0.7150	59900 13500	0.35	1.71	15500 3490	9310 2090	1.67	53900 12100		15115	15245	
29.987 1.1806	62.000 2.4409	19.050 0.7500	59900 13500	0.35	1.71	15500 3490	9310 2090	1.67	53900 12100		15117	15245	
29.987 1.1806	62.000 2.4409	20.638 0.8125	59900 13500	0.35	1.71	15500 3490	9310 2090	1.67	53900 12100		15117	15244	
29.987 1.1806	62.000 2.4409	20.638 0.8125	59900 13500	0.35	1.71	15500 3490	9310 2090	1.67	53900 12100		15117	15244X	
29.987 1.1806	63.500 2.5000	20.638 0.8125	59900 13500	0.35	1.71	15500 3490	9310 2090	1.67	53900 12100		15117	15250	
29.987 1.1806	68.262 2.6875	21.000 0.8268	63800 14300	0.42	1.44	16500 3720	11800 2650	1.40	70200 15800		02474A	02420A	
29.987 1.1806	69.012 2.7170	19.845 0.7813	64700 14500	0.38	1.57	16800 3770	11000 2470	1.53	61700 13900		14118AS	14276	
29.987 1.1806	72.000 2.8346	19.000 0.7480	69600 15700	0.36	1.67	18100 4060	11100 2500	1.62	60100 13500		26118	26283	
29.987 1.1806	76.200 3.0000	19.000 0.7480	69600 15700	0.36	1.67	18100 4060	11100 2500	1.62	60100 13500		26118	26300	
29.987 1.1806	76.200 3.0000	24.608 0.9688	77600 17500	0.67	0.90	20100 4520	23000 5170	0.87	76200 17100		43117	43300	
30.000 1.1811	62.000 2.4409	16.002 0.6300	43200 9720	0.38	1.57	11200 2520	7340 1650	1.53	44100 9910		17118-S	17244	
30.000 1.1811	68.956 2.7148	19.845 0.7813	54600 12300	0.38	1.57	14200 3180	9260 2080	1.53	61700 13900		14117A	14274A	
30.000 1.1811	69.012 2.7170	19.845 0.7813	54600 12300	0.38	1.57	14200 3180	9260 2080	1.53	61700 13900		14118	14276	
30.000 1.1811	69.012 2.7170	19.845 0.7813	54600 12300	0.38	1.57	14200 3180	9260 2080	1.53	61700 13900		14117A	14276	
30.000 1.1811	69.012 2.7170	19.845 0.7813	54600 12300	0.38	1.57	14200 3180	9260 2080	1.53	61700 13900		14118	14274	
30.000 1.1811	69.012 2.7170	19.845 0.7813	54600 12300	0.38	1.57	14200 3180	9260 2080	1.53	61700 13900		14118A	14274	

<sup>(1)</sup>Based on 1 x 10<sup>6</sup> revolutions L<sub>10</sub> life, for the ISO life-calculation method.

<sup>(2)</sup>Consult your Timken engineer for instructions on use or review the Timken Engineering Manual on timken.com/catalogs.

<sup>(3)</sup>Based on 90 x 10<sup>6</sup> revolutions L<sub>10</sub> life, for The Timken Company life-calculation method. C<sub>90</sub> and C<sub>a90</sub> are radial and thrust values.

Bearing Dimensions											Geometry Factors			Bearing Weight
Width B	Width C	Eff. Ctr. a <sup>(4)</sup>	Shaft			Housing			Cage		G <sub>1</sub>	G <sub>2</sub>	C <sub>g</sub>	
			Max Shaft Fillet Radius R <sup>(5)</sup>	Backing Shoulder Dia. d <sub>a</sub>	Backing Shoulder Dia. d <sub>b</sub>	Max Housing Fillet Radius r <sup>(5)</sup>	Backing Shoulder Dia. D <sub>a</sub>	Backing Shoulder Dia. D <sub>b</sub>	A <sub>a</sub> <sup>(6)</sup>	A <sub>b</sub> <sup>(7)</sup>				
mm in.	mm in.	mm in.	mm in.	mm in.	mm in.	mm in.	mm in.	mm in.	mm in.	mm in.				kg lbs.
16.566 0.6522	14.288 0.5625	-3.6 -0.14	1.5 0.06	36.0 1.42	38.5 1.52	1.5 0.06	57.0 2.24	54.0 2.13	0.2 0.01	1.9 0.08	11.8	7.5	0.0579	0.24 0.54
19.050 0.7500	14.288 0.5625	-4.8 -0.19	1.3 0.05	36.5 1.44	38.5 1.52	1.3 0.05	58.0 2.28	55.0 2.17	0.3 0.01	1.8 0.07	14.6	10.0	0.0606	0.26 0.56
20.638 0.8125	14.288 0.5625	-5.8 -0.23	1.3 0.05	35.0 1.38	36.5 1.44	1.3 0.05	58.0 2.28	55.0 2.17	1.1 0.04	1.1 0.05	14.6	10.0	0.0606	0.27 0.58
20.638 0.8125	15.875 0.6250	-5.8 -0.23	1.3 0.05	35.0 1.38	36.5 1.44	1.3 0.05	58.0 2.28	55.0 2.17	1.1 0.04	1.1 0.05	14.6	10.0	0.0606	0.28 0.61
20.638 0.8125	15.875 0.6250	-5.8 -0.23	1.3 0.05	35.0 1.38	36.5 1.44	1.5 0.06	58.0 2.28	55.0 2.17	1.1 0.04	1.1 0.05	14.6	10.0	0.0606	0.28 0.61
20.638 0.8125	15.875 0.6250	-5.8 -0.23	1.3 0.05	35.0 1.38	36.5 1.44	1.3 0.05	59.0 2.32	56.0 2.20	1.1 0.04	1.1 0.05	14.6	10.0	0.0606	0.30 0.65
22.225 0.8750	16.238 0.6393	-5.1 -0.20	0.8 0.03	38.5 1.52	39.5 1.56	1.5 0.06	63.0 2.48	59.0 2.32	1.1 0.04	0.9 0.04	17.5	8.5	0.0681	0.39 0.84
19.202 0.7560	15.875 0.6250	-4.3 -0.17	0.8 0.03	37.0 1.46	37.5 1.48	1.3 0.05	63.0 2.48	60.0 2.36	1.0 0.04	1.9 0.08	18.0	13.3	0.0668	0.36 0.80
18.923 0.7450	15.875 0.6250	-4.1 -0.16	1.5 0.06	36.0 1.42	38.0 1.50	1.5 0.06	65.0 2.56	62.0 2.44	0.5 0.02	1.1 0.05	16.1	10.1	0.0630	0.38 0.85
18.923 0.7450	15.875 0.6250	-4.1 -0.16	1.5 0.06	36.0 1.42	38.0 1.50	1.5 0.06	66.0 2.60	64.0 2.52	0.5 0.02	1.1 0.05	16.1	10.1	0.0630	0.44 0.98
24.074 0.9478	16.670 0.6563	-2.0 -0.08	1.5 0.06	42.1 1.66	44.5 1.75	3.3 0.13	73.0 2.87	64.0 2.52	3.4 0.13	2.4 0.10	16.8	7.6	0.0774	0.53 1.16
16.566 0.6522	14.288 0.5625	-3.6 -0.14	1.5 0.06	34.5 1.36	37.0 1.46	1.5 0.06	57.0 2.24	54.0 2.13	0.2 0.01	1.9 0.08	11.8	7.5	0.0579	0.24 0.54
19.583 0.7710	15.875 0.6250	-4.3 -0.17	3.5 0.14	41.0 1.61	44.0 1.73	3.3 0.13	63.0 2.48	59.0 2.32	1.0 0.04	1.5 0.06	18.0	13.3	0.0668	0.34 0.78
19.202 0.7560	15.875 0.6250	-4.3 -0.17	0.8 0.03	36.5 1.44	37.0 1.46	1.3 0.05	63.0 2.48	60.0 2.36	1.0 0.04	1.9 0.08	18.0	13.3	0.0668	0.35 0.79
19.583 0.7710	15.875 0.6250	-4.3 -0.17	3.5 0.14	41.0 1.61	44.0 1.73	1.3 0.05	63.0 2.48	60.0 2.36	1.0 0.04	1.5 0.06	18.0	13.3	0.0668	0.35 0.79
19.202 0.7560	15.875 0.6250	-4.3 -0.17	0.8 0.03	36.5 1.44	37.0 1.46	3.3 0.13	63.0 2.48	59.0 2.32	1.0 0.04	1.9 0.08	18.0	13.3	0.0668	0.35 0.78
19.583 0.7710	15.875 0.6250	-4.3 -0.17	3.5 0.14	37.0 1.46	43.0 1.69	3.3 0.13	63.0 2.48	59.0 2.32	1.0 0.04	1.5 0.06	18.0	13.3	0.0668	0.36 0.78

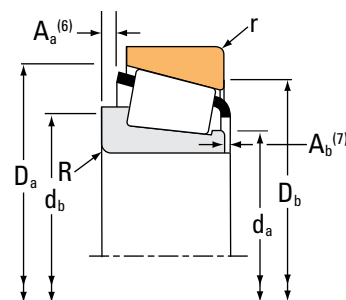
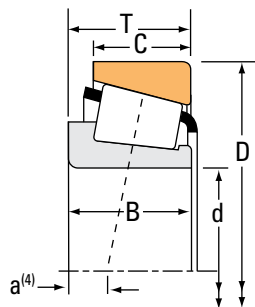
<sup>(4)</sup>Negative value indicates effective center inside cone (inner-ring) backface.  
<sup>(5)</sup>These maximum fillet radii will be cleared by the bearing corners.  
<sup>(6)</sup>Negative value indicates cage extends beyond cone (inner-ring) backface.  
<sup>(7)</sup>Negative value indicates cage that does not extend beyond cone (inner-ring) front face.

Continued on next page.

# TAPERED ROLLER BEARINGS

## SINGLE-ROW • TYPE TS

### TYPE TS



Bearing Dimensions			Load Ratings						Part Number				
Bore d	O.D. D	Width T	Dynamic <sup>(1)</sup>		Factors <sup>(2)</sup>		Dynamic <sup>(3)</sup>		Factors <sup>(2)</sup>		Static C <sub>0</sub>	Inner	Outer
			C <sub>1</sub>	e	Y	C <sub>90</sub>	C <sub>a90</sub>	K	N	N			
mm in.	mm in.	mm in.	N lbf			N lbf	N lbf		N lbf				
30.000 1.1811	69.850 2.7500	23.812 0.9375	83700 18800	0.27	2.19	21700 4880	10200 2280	2.14	94400 21200		2586	2523	
30.000 1.1811	69.850 2.7500	23.812 0.9375	83700 18800	0.27	2.19	21700 4880	10200 2280	2.14	94400 21200		2560X	2523-S	
30.000 1.1811	69.850 2.7500	23.812 0.9375	83700 18800	0.27	2.19	21700 4880	10200 2280	2.14	94400 21200		2560X	2523	
30.000 1.1811	72.000 2.8346	19.000 0.7480	69600 15700	0.36	1.67	18100 4060	11100 2500	1.62	60100 13500		26118-S	26283-S	
30.000 1.1811	72.000 2.8346	23.812 0.9375	83700 18800	0.27	2.19	21700 4880	10200 2280	2.14	94400 21200		2560X	2526X	
30.000 1.1811	72.000 2.8346	29.370 1.1563	87000 19600	0.55	1.10	22600 5070	21100 4740	1.07	111000 24900		JHM88540	JHM88513	
30.000 1.1811	72.022 2.8355	23.812 0.9375	83700 18800	0.27	2.19	21700 4880	10200 2280	2.14	94400 21200		2586	2525	
30.000 1.1811	72.034 2.8360	30.162 1.1875	94800 21300	0.33	1.80	24600 5520	14000 3140	1.76	102000 22800		3190	3126	
30.000 1.1811	72.085 2.8380	22.385 0.8813	54600 12300	0.38	1.57	14200 3180	9260 2080	1.53	61700 13900		14117A	14283	
30.000 1.1811	72.085 2.8380	22.385 0.8813	54600 12300	0.38	1.57	14200 3180	9260 2080	1.53	61700 13900		14118	14283	
30.112 1.1855	62.000 2.4409	19.050 0.7500	59900 13500	0.35	1.71	15500 3490	9310 2090	1.67	53900 12100		15116	15245	
30.112 1.1855	63.500 2.5000	20.638 0.8125	59900 13500	0.35	1.71	15500 3490	9310 2090	1.67	53900 12100		15116	15250	
30.162 1.1875	58.738 2.3125	14.684 0.5781	31700 7130	0.47	1.27	8220 1850	6670 1500	1.23	35000 7880		08118	08231	
30.162 1.1875	58.788 2.3145	14.684 0.5781	31700 7130	0.47	1.27	8220 1850	6670 1500	1.23	35000 7880		08118	08237	
30.162 1.1875	62.000 2.4409	16.002 0.6300	43200 9720	0.38	1.57	11200 2520	7340 1650	1.53	44100 9910		17119	17244	
30.162 1.1875	64.292 2.5312	21.433 0.8438	60200 13500	0.55	1.10	15600 3510	14600 3280	1.07	71700 16100		M86649	M86610	
30.162 1.1875	66.421 2.6150	19.050 0.7500	55900 12600	0.34	1.77	14500 3260	8420 1890	1.72	55200 12400		24118	24261	

<sup>(1)</sup>Based on  $1 \times 10^6$  revolutions  $L_{10}$  life, for the ISO life-calculation method.

<sup>(2)</sup>Consult your Timken engineer for instructions on use or review the Timken Engineering Manual on [timken.com/catalogs](http://timken.com/catalogs).

<sup>(3)</sup>Based on  $90 \times 10^6$  revolutions  $L_{10}$  life, for The Timken Company life-calculation method.  $C_{90}$  and  $C_{a90}$  are radial and thrust values.

Bearing Dimensions											Geometry Factors			Bearing Weight
Width B	Width C	Eff. Ctr. a <sup>(4)</sup>	Shaft			Housing			Cage		G <sub>1</sub>	G <sub>2</sub>	C <sub>g</sub>	
			Max Shaft Fillet Radius R <sup>(5)</sup>	Backing Shoulder Dia. d <sub>a</sub>	Shoulder Dia. d <sub>b</sub>	Max Housing Fillet Radius r <sup>(5)</sup>	Backing Shoulder Dia. D <sub>a</sub>	Shoulder Dia. D <sub>b</sub>	A <sub>a</sub> <sup>(6)</sup>	A <sub>b</sub> <sup>(7)</sup>				
mm in.	mm in.	mm in.	mm in.	mm in.	mm in.	mm in.	mm in.	mm in.	mm in.	mm in.				kg lbs.
25.357 0.9983	19.050 0.7500	-8.6 -0.34	3.5 0.14	36.0 1.42	42.5 1.67	1.3 0.05	64.0 2.52	61.0 2.40	0.8 0.03	0.8 0.04	23.6	9.6	0.0656	0.47 1.02
25.357 0.9983	19.050 0.7500	-8.6 -0.34	2.0 0.08	36.0 1.42	39.5 1.56	1.5 0.06	64.0 2.52	61.0 2.40	0.8 0.03	0.8 0.04	23.6	9.6	0.0656	0.47 1.03
25.357 0.9983	19.050 0.7500	-8.6 -0.34	2.0 0.08	36.0 1.42	39.5 1.56	1.3 0.05	64.0 2.52	61.0 2.40	0.8 0.03	0.8 0.04	23.6	9.6	0.0656	0.47 1.03
18.923 0.7450	15.875 0.6250	-4.1 -0.16	1.5 0.06	36.0 1.42	38.0 1.50	2.0 0.08	65.0 2.56	62.0 2.44	0.5 0.02	1.1 0.05	16.1	10.1	0.0630	0.38 0.84
25.357 0.9983	19.050 0.7500	-8.6 -0.34	2.0 0.08	36.0 1.42	39.5 1.56	2.0 0.08	65.0 2.56	61.0 2.40	0.8 0.03	0.8 0.04	23.6	9.6	0.0656	0.50 1.11
27.783 1.0938	23.020 0.9063	-5.6 -0.22	1.3 0.05	42.5 1.67	44.5 1.75	3.3 0.13	69.0 2.72	58.0 2.28	1.9 0.07	1.8 0.08	26.3	8.7	0.0857	0.60 1.34
25.357 0.9983	19.050 0.7500	-8.6 -0.34	3.5 0.14	36.0 1.42	42.5 1.67	0.8 0.03	65.0 2.56	63.0 2.48	0.8 0.03	0.8 0.04	23.6	9.6	0.0656	0.50 1.10
29.997 1.1810	23.812 0.9375	-10.2 -0.40	3.5 0.14	38.0 1.50	44.5 1.75	2.8 0.11	67.0 2.64	61.0 2.40	* *	* *	23.4	8.8	0.0697	0.60 1.30
19.583 0.7710	18.415 0.7250	-4.3 -0.17	3.5 0.14	41.0 1.61	44.0 1.73	2.3 0.09	65.0 2.56	60.0 2.36	1.0 0.04	1.5 0.06	18.0	13.3	0.0668	0.43 0.96
19.202 0.7560	18.415 0.7250	-4.3 -0.17	0.8 0.03	36.5 1.44	37.0 1.46	2.3 0.09	65.0 2.56	60.0 2.36	1.0 0.04	1.9 0.08	18.0	13.3	0.0668	0.43 0.96
20.638 0.8125	14.288 0.5625	-5.8 -0.23	0.8 0.03	35.5 1.40	36.0 1.42	1.3 0.05	58.0 2.28	55.0 2.17	1.2 0.04	1.1 0.05	14.6	10.0	0.0606	0.26 0.58
20.638 0.8125	15.875 0.6250	-5.8 -0.23	0.8 0.03	35.5 1.40	36.0 1.42	1.3 0.05	59.0 2.32	56.0 2.20	1.2 0.04	1.1 0.05	14.6	10.0	0.0606	0.29 0.65
15.080 0.5937	10.716 0.4219	-1.3 -0.05	3.5 0.14	35.0 1.38	41.5 1.63	1.0 0.04	55.0 2.17	52.0 2.05	0.8 0.03	1.1 0.05	10.7	10.6	0.0601	0.18 0.38
15.080 0.5937	10.716 0.4219	-1.3 -0.05	3.5 0.14	35.0 1.38	41.5 1.63	1.0 0.04	55.0 2.17	52.0 2.05	0.8 0.03	1.1 0.05	10.7	10.6	0.0601	0.18 0.38
16.566 0.6522	14.288 0.5625	-3.6 -0.14	1.5 0.06	34.5 1.36	37.0 1.46	1.5 0.06	57.0 2.24	54.0 2.13	0.2 0.01	1.9 0.08	11.8	7.5	0.0579	0.24 0.53
21.433 0.8438	16.670 0.6563	-3.3 -0.13	1.5 0.06	38.0 1.50	44.0 1.73	1.5 0.06	60.0 2.36	54.0 2.13	1.3 0.05	1.3 0.05	16.8	7.4	0.0736	0.34 0.74
18.974 0.7470	15.875 0.6250	-4.8 -0.19	1.5 0.06	35.0 1.38	37.5 1.48	1.5 0.06	61.0 2.40	58.0 2.28	0.3 0.01	1.5 0.06	14.0	8.3	0.0589	0.30 0.67

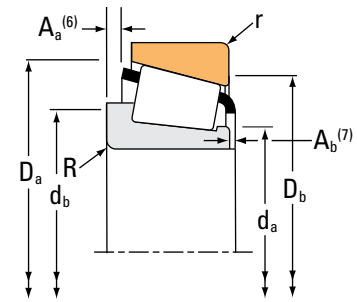
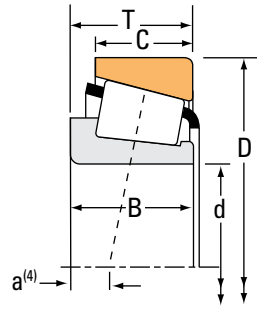
(4) Negative value indicates effective center inside cone (inner-ring) backface.  
 (5) These maximum fillet radii will be cleared by the bearing corners.  
 (6) Negative value indicates cage extends beyond cone (inner-ring) backface.  
 (7) Negative value indicates cage that does not extend beyond cone (inner-ring) front face.  
 (\*) Contact your Timken engineer for details.

Continued on next page.

# TAPERED ROLLER BEARINGS

## SINGLE-ROW • TYPE TS

### TYPE TS



Bearing Dimensions			Load Ratings						Part Number				
Bore d	O.D. D	Width T	Dynamic <sup>(1)</sup>		Factors <sup>(2)</sup>		Dynamic <sup>(3)</sup>		Factors <sup>(2)</sup>		Static C <sub>0</sub>	Inner	Outer
			C <sub>1</sub>	e	Y	C <sub>90</sub>	C <sub>a90</sub>	K	N	N			
mm in.	mm in.	mm in.	N lbf			N lbf	N lbf		N lbf				
30.162 1.1875	66.421 2.6150	25.400 1.0000	83700 18800	0.27	2.19	21700 4880	10200 2280	2.14	94400 21200		2558	2530	
30.162 1.1875	69.850 2.7500	23.812 0.9375	83700 18800	0.27	2.19	21700 4880	10200 2280	2.14	94400 21200		2558	2523	
30.162 1.1875	69.850 2.7500	23.812 0.9375	83700 18800	0.27	2.19	21700 4880	10200 2280	2.14	94400 21200		2558	2523-S	
30.162 1.1875	72.625 2.8593	30.162 1.1875	94800 21300	0.33	1.80	24600 5520	14000 3140	1.76	102000 22800		3191	3120	
30.162 1.1875	72.625 2.8593	30.162 1.1875	94800 21300	0.33	1.80	24600 5520	14000 3140	1.76	102000 22800		3187	3120	
30.162 1.1875	76.200 3.0000	20.638 0.8125	75200 16900	0.40	1.49	19500 4390	13400 3020	1.45	68900 15500		28118	28300	
30.162 1.1875	76.200 3.0000	24.608 0.9688	92000 20700	0.67	0.90	23900 5360	27300 6130	0.87	76200 17100		43118	43300	
30.162 1.1875	79.375 3.1250	25.400 1.0000	92000 20700	0.67	0.90	23900 5360	27300 6130	0.87	76200 17100		43118	43312	
30.162 1.1875	80.000 3.1496	21.006 0.8270	75200 16900	0.40	1.49	19500 4390	13400 3020	1.45	68900 15500		28118	28315	
30.175 1.1880	62.000 2.4409	19.050 0.7500	59900 13500	0.35	1.71	15500 3490	9310 2090	1.67	53900 12100		15120A	15245	
30.213 1.1895	62.000 2.4409	20.638 0.8125	59900 13500	0.35	1.71	15500 3490	9310 2090	1.67	53900 12100		15118	15244	
30.213 1.1895	62.000 2.4409	20.638 0.8125	59900 13500	0.35	1.71	15500 3490	9310 2090	1.67	53900 12100		15120	15244	
30.213 1.1895	63.500 2.5000	20.638 0.8125	59900 13500	0.35	1.71	15500 3490	9310 2090	1.67	53900 12100		15118	15250X	
30.213 1.1895	63.500 2.5000	20.638 0.8125	59900 13500	0.35	1.71	15500 3490	9310 2090	1.67	53900 12100		15119	15250	
30.213 1.1895	63.500 2.5000	20.638 0.8125	59900 13500	0.35	1.71	15500 3490	9310 2090	1.67	53900 12100		15120	15250	
30.213 1.1895	63.500 2.5000	20.638 0.8125	59900 13500	0.35	1.71	15500 3490	9310 2090	1.67	53900 12100		15118	15250	
30.213 1.1895	63.500 2.5000	20.638 0.8125	59900 13500	0.35	1.71	15500 3490	9310 2090	1.67	53900 12100		15119	15249	

<sup>(1)</sup>Based on  $1 \times 10^6$  revolutions  $L_{10}$  life, for the ISO life-calculation method.

<sup>(2)</sup>Consult your Timken engineer for instructions on use or review the Timken Engineering Manual on [timken.com/catalogs](http://timken.com/catalogs).

<sup>(3)</sup>Based on  $90 \times 10^6$  revolutions  $L_{10}$  life, for The Timken Company life-calculation method.  $C_{90}$  and  $C_{a90}$  are radial and thrust values.



Bearing Dimensions											Geometry Factors			Bearing Weight
Width B	Width C	Eff. Ctr. a <sup>(4)</sup>	Shaft			Housing			Cage		G <sub>1</sub>	G <sub>2</sub>	C <sub>g</sub>	
			Max Shaft Fillet Radius R <sup>(5)</sup>	Backing Shoulder Dia. d <sub>a</sub>	Backing Shoulder Dia. d <sub>b</sub>	Max Housing Fillet Radius r <sup>(5)</sup>	Backing Shoulder Dia. D <sub>a</sub>	Backing Shoulder Dia. D <sub>b</sub>	A <sub>a</sub> <sup>(6)</sup>	A <sub>b</sub> <sup>(7)</sup>				
mm in.	mm in.	mm in.	mm in.	mm in.	mm in.	mm in.	mm in.	mm in.	mm in.	mm in.				kg lbs.
25.357 0.9983	20.638 0.8125	-8.6 -0.34	2.3 0.09	36.5 1.44	40.0 1.57	0.8 0.03	62.5 2.46	59.9 2.36	0.8 0.03	0.8 0.04	23.6	9.6	0.0656	0.43 0.94
25.357 0.9983	19.050 0.7500	-8.6 -0.34	2.3 0.09	36.5 1.44	40.0 1.57	1.3 0.05	64.0 2.52	61.0 2.40	0.8 0.03	0.8 0.04	23.6	9.6	0.0656	0.47 1.03
25.357 0.9983	19.050 0.7500	-8.6 -0.34	2.3 0.09	36.5 1.44	40.0 1.57	1.5 0.06	64.0 2.52	61.0 2.40	0.8 0.03	0.8 0.04	23.6	9.6	0.0656	0.47 1.03
29.997 1.1810	23.812 0.9375	-10.2 -0.40	3.5 0.14	38.5 1.52	44.5 1.75	3.3 0.13	67.0 2.64	61.0 2.40	* *	* *	23.4	8.8	0.0697	0.60 1.32
29.997 1.1810	23.812 0.9375	-10.2 -0.40	0.8 0.03	38.5 1.52	39.0 1.54	3.3 0.13	67.0 2.64	61.0 2.40	* *	* *	23.4	8.8	0.0697	0.61 1.33
20.940 0.8244	15.507 0.6105	-4.8 -0.19	1.5 0.06	37.5 1.48	40.0 1.57	1.3 0.05	71.0 2.80	68.0 2.68	2.3 0.09	1.1 0.05	20.7	12.5	0.0709	0.47 1.04
24.074 0.9478	16.670 0.6563	-2.0 -0.08	1.5 0.06	42.1 1.65	45.0 1.77	3.3 0.13	73.0 2.87	64.0 2.52	3.4 0.13	2.4 0.10	16.8	7.6	0.0774	0.53 1.16
24.074 0.9478	17.462 0.6875	-2.0 -0.08	1.5 0.06	42.1 1.65	45.0 1.77	1.5 0.06	74.0 2.91	67.0 2.64	3.4 0.13	2.4 0.10	16.8	7.6	0.0774	0.60 1.31
20.940 0.8244	15.875 0.6250	-4.8 -0.19	1.5 0.06	37.5 1.48	40.0 1.57	1.5 0.06	73.0 2.87	69.0 2.72	2.3 0.09	1.1 0.05	20.7	12.5	0.0709	0.53 1.17
20.638 0.8125	14.288 0.5625	-5.8 -0.23	0.5 0.02	35.5 1.40	35.5 1.40	1.3 0.05	58.0 2.28	55.0 2.17	1.1 0.04	1.1 0.05	14.6	10.0	0.0606	0.26 0.58
20.638 0.8125	15.875 0.6250	-5.8 -0.23	3.5 0.14	36.5 1.44	43.0 1.69	1.3 0.05	58.0 2.28	55.0 2.17	1.1 0.04	1.1 0.05	14.6	10.0	0.0606	0.27 0.60
20.638 0.8125	15.875 0.6250	-5.8 -0.23	0.8 0.03	35.5 1.40	36.0 1.42	1.3 0.05	58.0 2.28	55.0 2.17	1.2 0.04	1.1 0.05	14.6	10.0	0.0606	0.27 0.61
20.638 0.8125	15.875 0.6250	-5.8 -0.23	3.5 0.14	36.5 1.44	43.0 1.69	1.5 0.06	59.0 2.32	55.0 2.17	1.1 0.04	1.1 0.05	14.6	10.0	0.0606	0.29 0.64
20.638 0.8125	15.875 0.6250	-5.8 -0.23	1.5 0.06	35.5 1.40	37.5 1.48	1.3 0.05	59.0 2.32	56.0 2.20	* *	* *	14.6	10.0	0.0606	0.29 0.65
20.638 0.8125	15.875 0.6250	-5.8 -0.23	0.8 0.03	35.5 1.40	36.0 1.42	1.3 0.05	59.0 2.32	56.0 2.20	1.2 0.04	1.1 0.05	14.6	10.0	0.0606	0.29 0.65
20.638 0.8125	15.875 0.6250	-5.8 -0.23	3.5 0.14	36.5 1.44	43.0 1.69	1.3 0.05	59.0 2.32	56.0 2.20	1.1 0.04	1.1 0.05	14.6	10.0	0.0606	0.29 0.64
20.638 0.8125	15.875 0.6250	-5.8 -0.23	1.5 0.06	35.5 1.40	37.5 1.48	1.5 0.06	59.0 2.32	55.0 2.17	* *	* *	14.6	10.0	0.0606	0.29 0.64

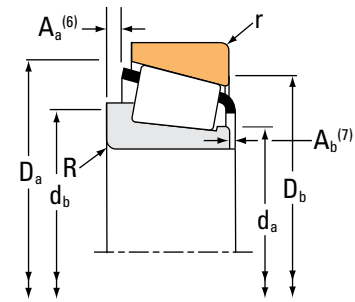
<sup>(4)</sup>Negative value indicates effective center inside cone (inner-ring) backface.  
<sup>(5)</sup>These maximum fillet radii will be cleared by the bearing corners.  
<sup>(6)</sup>Negative value indicates cage extends beyond cone (inner-ring) backface.  
<sup>(7)</sup>Negative value indicates cage that does not extend beyond cone (inner-ring) front face.  
<sup>(\*)</sup>Contact your Timken engineer for details.

Continued on next page.

# TAPERED ROLLER BEARINGS

## SINGLE-ROW • TYPE TS

### TYPE TS



Bearing Dimensions			Load Ratings						Part Number				
Bore d	O.D. D	Width T	Dynamic <sup>(1)</sup>		Factors <sup>(2)</sup>		Dynamic <sup>(3)</sup>		Factors <sup>(2)</sup>		Static C <sub>0</sub>	Inner	Outer
			C <sub>1</sub>	e	Y	C <sub>90</sub>	C <sub>a90</sub>	K	N	N			
mm in.	mm in.	mm in.	N lbf			N lbf	N lbf		N lbf				
30.213 1.1895	66.421 2.6150	25.400 1.0000	83700 18800	0.27	2.19	21700 4880	10200 2280	2.14	94400 21200		2561X	2520	
30.213 1.1895	69.850 2.7500	23.812 0.9375	83700 18800	0.27	2.19	21700 4880	10200 2280	2.14	94400 21200		2561X	2523	
30.213 1.1895	69.850 2.7500	23.812 0.9375	83700 18800	0.27	2.19	21700 4880	10200 2280	2.14	94400 21200		2561X	2523-S	
30.226 1.1900	69.012 2.7170	19.845 0.7813	54600 12300	0.38	1.57	14200 3180	9260 2080	1.53	61700 13900		14116	14276	
30.955 1.2187	64.292 2.5312	21.432 0.8438	60200 13500	0.55	1.10	15600 3510	14600 3280	1.07	71700 16100		M86648A	M86610	
31.623 1.2450	66.675 2.6250	20.638 0.8125	52500 11800	0.37	1.62	13600 3060	8650 1950	1.57	57900 13000		1674	1620	
31.750 1.2500	58.738 2.3125	14.684 0.5781	31700 7130	0.47	1.27	8220 1850	6670 1500	1.23	35000 7880		08125	08231	
31.750 1.2500	59.131 2.3280	15.875 0.6250	46700 10500	0.41	1.46	12100 2720	8550 1920	1.42	44600 10000		LM67048	LM67010	
31.750 1.2500	59.131 2.3280	15.875 0.6250	46700 10500	0.41	1.46	12100 2720	8550 1920	1.42	44600 10000		LM67047	LM67010	
31.750 1.2500	59.131 2.3280	15.875 0.6250	46700 10500	0.41	1.46	12100 2720	8550 1920	1.42	44600 10000		LM67049A	LM67010	
31.750 1.2500	59.131 2.3280	15.875 0.6250	46700 10500	0.41	1.46	12100 2720	8550 1920	1.42	44600 10000		LM67045	LM67010	
31.750 1.2500	61.986 2.4404	15.875 0.6250	46700 10500	0.41	1.46	12100 2720	8550 1920	1.42	44600 10000		LM67048	LM67014	
31.750 1.2500	61.986 2.4404	15.875 0.6250	46700 10500	0.41	1.46	12100 2720	8550 1920	1.42	44600 10000		LM67049A	LM67014	
31.750 1.2500	61.986 2.4404	15.875 0.6250	46700 10500	0.41	1.46	12100 2720	8550 1920	1.42	44600 10000		LM67045	LM67014	
31.750 1.2500	62.000 2.4409	18.161 0.7150	59900 13500	0.35	1.71	15500 3490	9310 2090	1.67	53900 12100		15123	15245	
31.750 1.2500	62.000 2.4409	19.050 0.7500	59900 13500	0.35	1.71	15500 3490	9310 2090	1.67	53900 12100		15126	15245	
31.750 1.2500	62.000 2.4409	19.050 0.7500	59900 13500	0.35	1.71	15500 3490	9310 2090	1.67	53900 12100		15125	15245	

<sup>(1)</sup>Based on 1 x 10<sup>6</sup> revolutions L<sub>10</sub> life, for the ISO life-calculation method.

<sup>(2)</sup>Consult your Timken engineer for instructions on use or review the Timken Engineering Manual on timken.com/catalogs.

<sup>(3)</sup>Based on 90 x 10<sup>6</sup> revolutions L<sub>10</sub> life, for The Timken Company life-calculation method. C<sub>90</sub> and C<sub>a90</sub> are radial and thrust values.

Bearing Dimensions											Geometry Factors			Bearing Weight
Width B	Width C	Eff. Ctr. a <sup>(4)</sup>	Shaft			Housing			Cage		G <sub>1</sub>	G <sub>2</sub>	C <sub>g</sub>	
			Max Shaft Fillet Radius R <sup>(5)</sup>	Backing Shoulder Dia. d <sub>a</sub>	Backing Shoulder Dia. d <sub>b</sub>	Max Housing Fillet Radius r <sup>(5)</sup>	Backing Shoulder Dia. D <sub>a</sub>	Backing Shoulder Dia. D <sub>b</sub>	A <sub>a</sub> <sup>(6)</sup>	A <sub>b</sub> <sup>(7)</sup>				
mm in.	mm in.	mm in.	mm in.	mm in.	mm in.	mm in.	mm in.	mm in.	mm in.	mm in.				kg lbs.
24.714 0.9730	20.638 0.8125	-8.6 -0.34	2.3 0.09	36.5 1.44	40.0 1.57	3.3 0.13	62.5 2.46	56.9 2.24	0.8 0.03	1.5 0.06	23.6	9.6	0.0656	0.41 0.91
24.714 0.9730	19.050 0.7500	-8.6 -0.34	2.3 0.09	36.5 1.44	40.0 1.57	1.3 0.05	64.0 2.52	61.0 2.40	0.8 0.03	1.5 0.06	23.6	9.6	0.0656	0.46 1.02
24.714 0.9730	19.050 0.7500	-8.6 -0.34	2.3 0.09	36.5 1.44	40.0 1.57	1.5 0.06	64.0 2.52	61.0 2.40	0.8 0.03	1.5 0.06	23.6	9.6	0.0656	0.46 1.02
19.583 0.7710	15.875 0.6250	-4.3 -0.17	0.8 0.03	38.0 1.50	38.5 1.52	1.3 0.05	63.0 2.48	60.0 2.36	1.0 0.04	1.5 0.06	18.0	13.3	0.0668	0.36 0.80
21.433 0.8438	16.670 0.6563	-3.3 -0.13	1.5 0.06	38.0 1.50	42.0 1.65	1.5 0.06	60.0 2.36	54.0 2.13	1.3 0.05	1.3 0.05	16.8	7.4	0.0736	0.33 0.73
20.638 0.8125	15.875 0.6250	-5.3 -0.21	1.5 0.06	37.0 1.46	39.5 1.56	1.5 0.06	61.0 2.40	58.0 2.28	1.5 0.06	1.1 0.05	16.6	8.7	0.0644	0.33 0.72
15.080 0.5937	10.716 0.4219	-1.3 -0.05	1.0 0.04	36.0 1.42	37.5 1.48	1.0 0.04	55.0 2.17	52.0 2.05	0.8 0.03	1.1 0.05	10.7	10.6	0.0601	0.17 0.37
16.764 0.6600	11.811 0.4650	-3.0 -0.12	3.5 0.14	36.0 1.42	42.5 1.67	1.3 0.05	56.0 2.20	52.0 2.05	0.7 0.02	0.8 0.03	12.8	9.7	0.0612	0.18 0.39
16.764 0.6600	11.811 0.4650	-3.0 -0.12	2.3 0.09	36.0 1.42	40.0 1.57	1.3 0.05	56.0 2.20	52.0 2.05	0.7 0.02	0.8 0.03	12.8	9.7	0.0612	0.18 0.41
16.764 0.6600	11.811 0.4650	-3.0 -0.12	0.8 0.03	36.0 1.42	37.0 1.46	1.3 0.05	56.0 2.20	52.0 2.05	0.7 0.02	0.8 0.03	12.8	9.7	0.0612	0.18 0.41
18.500 0.7283	11.811 0.4650	-3.0 -0.12	2.0 0.08	36.0 1.42	39.5 1.56	1.3 0.05	56.0 2.20	52.0 2.05	0.7 0.03	-1.0 -0.04	12.8	9.7	0.0612	0.19 0.42
16.764 0.6600	11.811 0.4650	-3.0 -0.12	3.5 0.14	36.0 1.42	42.5 1.67	1.3 0.05	57.0 2.24	54.0 2.13	0.7 0.02	0.8 0.03	12.8	9.7	0.0612	0.21 0.44
16.764 0.6600	11.811 0.4650	-3.0 -0.12	0.8 0.03	36.0 1.42	37.0 1.46	1.3 0.05	57.0 2.24	54.0 2.13	0.7 0.02	0.8 0.03	12.8	9.7	0.0612	0.21 0.46
18.500 0.7283	11.811 0.4650	-3.0 -0.12	2.0 0.08	36.0 1.42	39.5 1.56	1.3 0.05	57.0 2.24	54.0 2.13	0.7 0.03	-1.0 -0.04	12.8	9.7	0.0612	0.22 0.47
19.050 0.7500	14.288 0.5625	-4.8 -0.19	3.5 0.14	38.0 1.50	44.0 1.73	1.3 0.05	58.0 2.28	55.0 2.17	0.3 0.01	1.8 0.07	14.6	10.0	0.0606	0.23 0.51
20.638 0.8125	14.288 0.5625	-5.8 -0.23	0.8 0.03	38.0 1.50	38.5 1.52	1.3 0.05	58.0 2.28	55.0 2.17	1.1 0.04	1.1 0.05	14.6	10.0	0.0606	0.25 0.55
20.638 0.8125	14.288 0.5625	-5.8 -0.23	3.5 0.14	36.5 1.44	42.5 1.67	1.3 0.05	58.0 2.28	55.0 2.17	1.2 0.04	1.1 0.05	14.6	10.0	0.0606	0.25 0.54

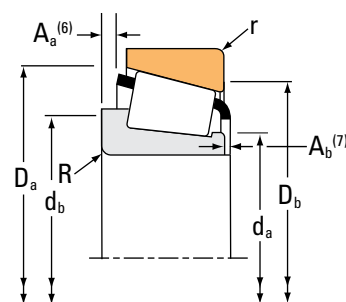
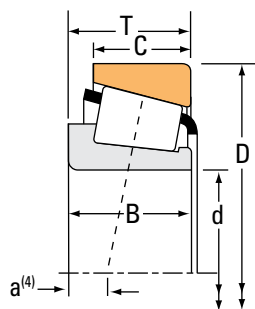
(4) Negative value indicates effective center inside cone (inner-ring) backface.  
 (5) These maximum fillet radii will be cleared by the bearing corners.  
 (6) Negative value indicates cage extends beyond cone (inner-ring) backface.  
 (7) Negative value indicates cage that does not extend beyond cone (inner-ring) front face.

Continued on next page.

# TAPERED ROLLER BEARINGS

## SINGLE-ROW • TYPE TS

### TYPE TS



Bearing Dimensions			Load Ratings					Part Number				
Bore d	O.D. D	Width T	Dynamic <sup>(1)</sup>		Factors <sup>(2)</sup>		Dynamic <sup>(3)</sup>		Static		Inner	Outer
			C <sub>1</sub>	e	Y	C <sub>90</sub>	C <sub>a90</sub>	K	C <sub>0</sub>			
mm in.	mm in.	mm in.	N lbf			N lbf	N lbf		N lbf			
31.750 1.2500	62.000 2.4409	20.638 0.8125	59900 13500	0.35	1.71	15500 3490	9310 2090	1.67	53900 12100		15125	15244
31.750 1.2500	62.000 2.4409	20.638 0.8125	59900 13500	0.35	1.71	15500 3490	9310 2090	1.67	53900 12100		15126	15244
31.750 1.2500	63.500 2.5000	19.748 0.7775	59900 13500	0.35	1.71	15500 3490	9310 2090	1.67	53900 12100		15123	15250
31.750 1.2500	63.500 2.5000	20.638 0.8125	59900 13500	0.35	1.71	15500 3490	9310 2090	1.67	53900 12100		15125	15250
31.750 1.2500	63.500 2.5000	20.638 0.8125	59900 13500	0.35	1.71	15500 3490	9310 2090	1.67	53900 12100		15126	15250
31.750 1.2500	63.500 2.5000	20.638 0.8125	59900 13500	0.35	1.71	15500 3490	9310 2090	1.67	53900 12100		15126	15250X
31.750 1.2500	66.421 2.6150	25.400 1.0000	83700 18800	0.27	2.19	21700 4880	10200 2280	2.14	94400 21200		2580	2520
31.750 1.2500	66.421 2.6150	25.400 1.0000	83700 18800	0.27	2.19	21700 4880	10200 2280	2.14	94400 21200		2580	2530
31.750 1.2500	66.421 2.6150	25.400 1.0000	83700 18800	0.27	2.19	21700 4880	10200 2280	2.14	94400 21200		2580	2520A
31.750 1.2500	66.421 2.6150	25.400 1.0000	83700 18800	0.27	2.19	21700 4880	10200 2280	2.14	94400 21200		2580A	2520A
31.750 1.2500	68.262 2.6875	21.000 0.8268	63800 14300	0.42	1.44	16500 3720	11800 2650	1.40	70200 15800		02476	02420A
31.750 1.2500	68.262 2.6875	22.225 0.8750	67600 15200	0.34	1.77	17500 3940	10200 2290	1.72	73300 16500		2475	2420
31.750 1.2500	68.262 2.6875	22.225 0.8750	63800 14300	0.42	1.44	16500 3720	11800 2650	1.40	70200 15800		02475	02420
31.750 1.2500	68.262 2.6875	22.225 0.8750	66700 15000	0.28	2.18	17300 3890	8150 1830	2.12	77900 17500		16579	16522
31.750 1.2500	68.262 2.6875	22.225 0.8750	63800 14300	0.42	1.44	16500 3720	11800 2650	1.40	70200 15800		02476	02420
31.750 1.2500	68.262 2.6875	22.225 0.8750	76300 17100	0.55	1.10	19800 4450	18500 4160	1.07	77400 17400		M88046	M88010
31.750 1.2500	68.262 2.6875	26.988 1.0625	80700 18100	0.35	1.71	20900 4700	12600 2830	1.66	91000 20500		23491	23420

<sup>(1)</sup>Based on  $1 \times 10^6$  revolutions  $L_{10}$  life, for the ISO life-calculation method.

<sup>(2)</sup>Consult your Timken engineer for instructions on use or review the Timken Engineering Manual on [timken.com/catalogs](http://timken.com/catalogs).

<sup>(3)</sup>Based on  $90 \times 10^6$  revolutions  $L_{10}$  life, for The Timken Company life-calculation method.  $C_{90}$  and  $C_{a90}$  are radial and thrust values.

Bearing Dimensions											Geometry Factors			Bearing Weight
Width B	Width C	Eff. Ctr. a <sup>(4)</sup>	Shaft			Housing			Cage		G <sub>1</sub>	G <sub>2</sub>	C <sub>g</sub>	
			Max Shaft Fillet Radius R <sup>(5)</sup>	Backing Shoulder Dia. d <sub>a</sub>	Backing Shoulder Dia. d <sub>b</sub>	Max Housing Fillet Radius r <sup>(5)</sup>	Backing Shoulder Dia. D <sub>a</sub>	Backing Shoulder Dia. D <sub>b</sub>	A <sub>a</sub> <sup>(6)</sup>	A <sub>b</sub> <sup>(7)</sup>				
mm in.	mm in.	mm in.	mm in.	mm in.	mm in.	mm in.	mm in.	mm in.	mm in.	mm in.				kg lbs.
20.638 0.8125	15.875 0.6250	-5.8 -0.23	3.5 0.14	36.5 1.44	42.5 1.67	1.3 0.05	58.0 2.28	55.0 2.17	1.2 0.04	1.1 0.05	14.6	10.0	0.0606	0.26 0.57
20.638 0.8125	15.875 0.6250	-5.8 -0.23	0.8 0.03	38.0 1.50	38.5 1.52	1.3 0.05	58.0 2.28	55.0 2.17	1.1 0.04	1.1 0.05	14.6	10.0	0.0606	0.26 0.58
19.050 0.7500	15.875 0.6250	-4.8 -0.19	3.5 0.14	38.0 1.50	44.0 1.73	1.3 0.05	59.0 2.32	56.0 2.20	0.3 0.01	1.8 0.07	14.6	10.0	0.0606	0.26 0.58
20.638 0.8125	15.875 0.6250	-5.8 -0.23	3.5 0.14	36.5 1.44	42.5 1.67	1.3 0.05	59.0 2.32	56.0 2.20	1.2 0.04	1.1 0.05	14.6	10.0	0.0606	0.28 0.61
20.638 0.8125	15.875 0.6250	-5.8 -0.23	0.8 0.03	38.0 1.50	38.5 1.52	1.3 0.05	59.0 2.32	56.0 2.20	1.1 0.04	1.1 0.05	14.6	10.0	0.0606	0.28 0.62
20.638 0.8125	15.875 0.6250	-5.8 -0.23	0.8 0.03	38.0 1.50	38.5 1.52	1.5 0.06	59.0 2.32	55.0 2.17	1.1 0.04	1.1 0.05	14.6	10.0	0.0606	0.28 0.62
25.357 0.9983	20.638 0.8125	-8.6 -0.34	0.8 0.03	37.5 1.48	38.5 1.52	3.3 0.13	62.5 2.46	56.9 2.24	0.8 0.03	0.8 0.04	23.6	9.6	0.0656	0.40 0.89
25.357 0.9983	20.638 0.8125	-8.6 -0.34	0.8 0.03	37.5 1.48	38.5 1.52	0.8 0.03	62.5 2.46	59.9 2.36	0.8 0.03	0.8 0.04	23.6	9.6	0.0656	0.41 0.91
25.357 0.9983	20.638 0.8125	-8.6 -0.34	0.8 0.03	37.5 1.48	38.5 1.52	1.5 0.06	62.0 2.44	58.9 2.32	0.8 0.03	0.8 0.04	23.6	9.6	0.0656	0.41 0.91
25.357 0.9983	20.638 0.8125	-8.6 -0.34	1.3 0.05	39.5 1.56	41.5 1.63	1.5 0.06	62.0 2.44	58.9 2.32	0.8 0.03	0.8 0.04	23.6	9.6	0.0656	0.41 0.91
22.225 0.8750	16.238 0.6393	-5.1 -0.20	0.8 0.03	38.5 1.52	39.0 1.54	1.5 0.06	63.0 2.48	59.0 2.32	1.1 0.04	0.9 0.04	17.5	8.5	0.0681	0.37 0.81
23.812 0.9375	17.462 0.6875	-6.6 -0.26	3.5 0.14	37.5 1.48	44.0 1.73	1.5 0.06	63.0 2.48	60.0 2.36	0.9 0.03	0.3 0.01	18.8	10.5	0.0652	0.38 0.83
22.225 0.8750	17.462 0.6875	-5.1 -0.20	3.5 0.14	38.5 1.52	44.5 1.75	1.5 0.06	63.0 2.48	59.0 2.32	1.1 0.04	0.9 0.04	17.5	8.5	0.0681	0.38 0.82
22.225 0.8750	17.462 0.6875	-7.4 -0.29	1.5 0.06	37.5 1.48	39.5 1.56	0.8 0.03	63.0 2.48	61.0 2.40	0.6 0.02	1.6 0.06	22.7	13.0	0.0650	0.39 0.85
22.225 0.8750	17.462 0.6875	-5.1 -0.20	0.8 0.03	38.5 1.52	39.0 1.54	1.5 0.06	63.0 2.48	59.0 2.32	1.1 0.04	0.9 0.04	17.5	8.5	0.0681	0.38 0.83
22.225 0.8750	17.462 0.6875	-2.8 -0.11	1.5 0.06	40.5 1.59	43.0 1.69	1.5 0.06	65.0 2.56	58.0 2.28	1.7 0.06	1.0 0.04	19.4	10.0	0.0771	0.39 0.87
26.988 1.0625	22.225 0.8750	-8.6 -0.34	1.5 0.06	39.0 1.54	41.0 1.61	1.5 0.06	64.0 2.52	59.0 2.32	1.6 0.06	0.7 0.03	21.9	10.4	0.0697	0.46 1.02

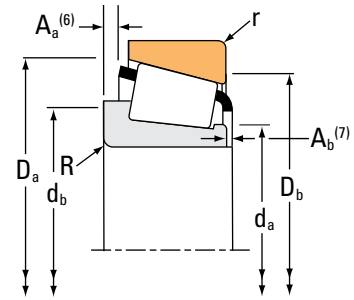
(4) Negative value indicates effective center inside cone (inner-ring) backface.  
 (5) These maximum fillet radii will be cleared by the bearing corners.  
 (6) Negative value indicates cage extends beyond cone (inner-ring) backface.  
 (7) Negative value indicates cage that does not extend beyond cone (inner-ring) front face.

Continued on next page.

# TAPERED ROLLER BEARINGS

## SINGLE-ROW • TYPE TS

### TYPE TS



Bearing Dimensions			Load Ratings						Part Number				
Bore d	O.D. D	Width T	Dynamic <sup>(1)</sup>		Factors <sup>(2)</sup>		Dynamic <sup>(3)</sup>		Factors <sup>(2)</sup>		Static C <sub>0</sub>	Inner	Outer
			C <sub>1</sub>	e	Y	C <sub>90</sub>	C <sub>a90</sub>	K	N	N			
mm in.	mm in.	mm in.	N lbf			N lbf	N lbf		N lbf				
31.750 1.2500	69.012 2.7170	19.845 0.7813	54600 12300	0.38	1.57	14200 3180	9260 2080	1.53	61700 13900		14125A	14274	
31.750 1.2500	69.012 2.7170	19.845 0.7813	54600 12300	0.38	1.57	14200 3180	9260 2080	1.53	61700 13900		14124	14276	
31.750 1.2500	69.012 2.7170	19.845 0.7813	54600 12300	0.38	1.57	14200 3180	9260 2080	1.53	61700 13900		14125A	14276	
31.750 1.2500	69.012 2.7170	19.845 0.7813	54600 12300	0.38	1.57	14200 3180	9260 2080	1.53	61700 13900		14124	14274	
31.750 1.2500	69.012 2.7170	22.385 0.8813	54600 12300	0.38	1.57	14200 3180	9260 2080	1.53	61700 13900		14124	14277	
31.750 1.2500	69.850 2.7500	23.812 0.9375	83700 18800	0.27	2.19	21700 4880	10200 2280	2.14	94400 21200		2582	2523	
31.750 1.2500	69.850 2.7500	23.812 0.9375	83700 18800	0.27	2.19	21700 4880	10200 2280	2.14	94400 21200		2580	2523	
31.750 1.2500	69.850 2.7500	23.812 0.9375	83700 18800	0.27	2.19	21700 4880	10200 2280	2.14	94400 21200		2580	2523-S	
31.750 1.2500	71.996 2.8345	19.002 0.7481	54600 12300	0.38	1.57	14200 3180	9260 2080	1.53	61700 13900		14124	14282	
31.750 1.2500	72.022 2.8355	23.812 0.9375	83700 18800	0.27	2.19	21700 4880	10200 2280	2.14	94400 21200		2582	2525	
31.750 1.2500	72.233 2.8438	25.400 1.0000	76800 17300	0.55	1.10	19900 4480	18600 4180	1.07	94200 21200		HM88644	HM88610	
31.750 1.2500	72.625 2.8593	25.400 1.0000	76800 17300	0.55	1.10	19900 4480	18600 4180	1.07	94200 21200		HM88644	HM88611AS	
31.750 1.2500	72.625 2.8593	30.162 1.1875	94800 21300	0.33	1.80	24600 5520	14000 3140	1.76	102000 22800		3193	3120	
31.750 1.2500	72.625 2.8593	30.162 1.1875	94800 21300	0.33	1.80	24600 5520	14000 3140	1.76	102000 22800		3188	3120	
31.750 1.2500	72.625 2.8593	30.162 1.1875	94800 21300	0.33	1.80	24600 5520	14000 3140	1.76	102000 22800		3199	3120	
31.750 1.2500	73.025 2.8750	22.225 0.8750	73200 16400	0.37	1.63	19000 4260	12000 2690	1.59	83800 18800		2875	2820	
31.750 1.2500	73.025 2.8750	22.225 0.8750	65700 14800	0.45	1.32	17000 3830	13200 2980	1.29	74900 16800		02875	02820	

<sup>(1)</sup>Based on 1 x 10<sup>6</sup> revolutions L<sub>10</sub> life, for the ISO life-calculation method.

<sup>(2)</sup>Consult your Timken engineer for instructions on use or review the Timken Engineering Manual on timken.com/catalogs.

<sup>(3)</sup>Based on 90 x 10<sup>6</sup> revolutions L<sub>10</sub> life, for The Timken Company life-calculation method. C<sub>90</sub> and C<sub>a90</sub> are radial and thrust values.

Bearing Dimensions											Geometry Factors			Bearing Weight
Width B	Width C	Eff. Ctr. a <sup>(4)</sup>	Shaft			Housing			Cage		G <sub>1</sub>	G <sub>2</sub>	C <sub>g</sub>	
			Max Shaft Fillet Radius R <sup>(5)</sup>	Backing Shoulder Dia. d <sub>a</sub> d <sub>b</sub>		Max Housing Fillet Radius r <sup>(5)</sup>	Backing Shoulder Dia. D <sub>a</sub> D <sub>b</sub>		A <sub>a</sub> <sup>(6)</sup>	A <sub>b</sub> <sup>(7)</sup>				
mm in.	mm in.	mm in.	mm in.	mm in.	mm in.	mm in.	mm in.	mm in.	mm in.	mm in.				kg lbs.
19.583 0.7710	15.875 0.6250	-4.3 -0.17	3.5 0.14	39.0 1.54	45.0 1.77	3.3 0.13	63.0 2.48	59.0 2.32	1.0 0.04	1.5 0.06	18.0	13.3	0.0668	0.34 0.75
19.583 0.7710	15.875 0.6250	-4.3 -0.17	0.8 0.03	39.0 1.54	39.5 1.56	1.3 0.05	63.0 2.48	60.0 2.36	1.0 0.04	1.5 0.06	18.0	13.3	0.0668	0.34 0.77
19.583 0.7710	15.875 0.6250	-4.3 -0.17	3.5 0.14	39.0 1.54	45.0 1.77	1.3 0.05	63.0 2.48	60.0 2.36	1.0 0.04	1.5 0.06	18.0	13.3	0.0668	0.34 0.77
19.583 0.7710	15.875 0.6250	-4.3 -0.17	0.8 0.03	39.0 1.54	39.5 1.56	3.3 0.13	63.0 2.48	59.0 2.32	1.0 0.04	1.5 0.06	18.0	13.3	0.0668	0.34 0.76
19.583 0.7710	18.415 0.7250	-4.3 -0.17	0.8 0.03	39.0 1.54	39.5 1.56	2.3 0.09	63.0 2.48	59.0 2.32	1.0 0.04	1.5 0.06	18.0	13.3	0.0668	0.37 0.83
25.357 0.9983	19.050 0.7500	-8.6 -0.34	3.5 0.14	37.5 1.48	44.0 1.73	1.3 0.05	64.0 2.52	61.0 2.40	0.8 0.03	0.8 0.04	23.6	9.6	0.0656	0.45 0.99
25.357 0.9983	19.050 0.7500	-8.6 -0.34	0.8 0.03	37.5 1.48	38.5 1.52	1.3 0.05	64.0 2.52	61.0 2.40	0.8 0.03	0.8 0.04	23.6	9.6	0.0656	0.45 1.00
25.357 0.9983	19.050 0.7500	-8.6 -0.34	0.8 0.03	37.5 1.48	38.5 1.52	1.5 0.06	64.0 2.52	61.0 2.40	0.8 0.03	0.8 0.04	23.6	9.6	0.0656	0.45 0.99
19.583 0.7710	15.032 0.5918	-4.3 -0.17	0.8 0.03	39.0 1.54	39.5 1.56	1.5 0.06	65.0 2.56	62.0 2.44	1.0 0.04	1.5 0.06	18.0	13.3	0.0668	0.37 0.84
25.357 0.9983	19.050 0.7500	-8.6 -0.34	3.5 0.14	37.5 1.48	44.0 1.73	0.8 0.03	65.0 2.56	63.0 2.48	0.8 0.03	0.8 0.04	23.6	9.6	0.0656	0.48 1.07
25.400 1.0000	19.842 0.7812	-4.6 -0.18	1.5 0.06	42.5 1.67	44.5 1.75	2.3 0.09	69.0 2.72	60.0 2.36	1.6 0.06	1.7 0.07	23.4	9.4	0.0822	0.51 1.15
25.400 1.0000	19.842 0.7812	-4.6 -0.18	1.5 0.06	42.5 1.67	44.5 1.75	3.3 0.13	69.0 2.72	59.0 2.32	1.6 0.06	1.7 0.07	23.4	9.4	0.0822	0.52 1.16
29.997 1.1810	23.812 0.9375	-10.2 -0.40	3.5 0.14	39.5 1.56	45.5 1.79	3.3 0.13	67.0 2.64	61.0 2.40	1.5 0.06	0.6 0.02	23.4	8.8	0.0697	0.59 1.28
29.997 1.1810	23.812 0.9375	-10.2 -0.40	0.8 0.03	39.5 1.56	40.0 1.57	3.3 0.13	67.0 2.64	61.0 2.40	1.5 0.06	0.6 0.02	23.4	8.8	0.0697	0.59 1.29
29.997 1.1810	23.812 0.9375	-10.2 -0.40	2.3 0.09	39.5 1.56	43.0 1.69	3.3 0.13	67.0 2.64	61.0 2.40	0.0 0.00	0.0 0.00	23.4	8.8	0.0697	0.59 1.28
23.812 0.9375	17.462 0.6875	-5.6 -0.22	3.5 0.14	38.5 1.52	45.0 1.77	3.3 0.13	68.0 2.68	63.0 2.48	0.9 0.03	0.2 0.01	23.1	12.4	0.0718	0.45 1.01
22.225 0.8750	17.462 0.6875	-3.8 -0.15	3.5 0.14	39.5 1.56	45.5 1.79	3.3 0.13	68.0 2.68	62.0 2.44	1.4 0.05	1.0 0.04	20.6	10.1	0.0740	0.44 0.97

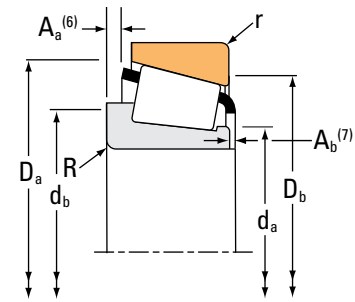
(4) Negative value indicates effective center inside cone (inner-ring) backface.  
 (5) These maximum fillet radii will be cleared by the bearing corners.  
 (6) Negative value indicates cage extends beyond cone (inner-ring) backface.  
 (7) Negative value indicates cage that does not extend beyond cone (inner-ring) front face.

Continued on next page.

# TAPERED ROLLER BEARINGS

## SINGLE-ROW • TYPE TS

### TYPE TS



Bearing Dimensions			Load Ratings							Part Number			
Bore d	O.D. D	Width T	Dynamic <sup>(1)</sup>		Factors <sup>(2)</sup>		Dynamic <sup>(3)</sup>		Factors <sup>(2)</sup>		Static C <sub>0</sub>	Inner	Outer
			C <sub>1</sub>	e	Y	C <sub>90</sub>	C <sub>a90</sub>	K	N	N			
mm in.	mm in.	mm in.	N lbf			N lbf	N lbf		N lbf				
31.750 1.2500	73.025 2.8750	22.225 0.8750	65700 14800	0.45	1.32	17000 3830	13200 2980	1.29	74900 16800		02876	02820	
31.750 1.2500	73.025 2.8750	22.225 0.8750	73200 16400	0.37	1.63	19000 4260	12000 2690	1.59	83800 18800		2879	2820	
31.750 1.2500	73.025 2.8750	26.988 1.0625	89400 20100	0.37	1.62	23200 5210	14700 3300	1.58	102000 22900		23685	23620	
31.750 1.2500	73.025 2.8750	29.370 1.1563	103000 23200	0.55	1.10	26700 6010	25000 5620	1.07	111000 24900		HM88542	HM88510	
31.750 1.2500	76.200 3.0000	23.812 0.9375	86900 19500	0.30	1.98	22500 5060	11700 2630	1.93	102000 23000		2783	2720	
31.750 1.2500	76.200 3.0000	24.608 0.9688	92000 20700	0.67	0.90	23900 5360	27300 6130	0.87	76200 17100		43125	43300	
31.750 1.2500	76.200 3.0000	29.370 1.1563	110000 24800	0.55	1.10	28600 6440	26800 6020	1.07	119000 26700		HM89440	HM89410	
31.750 1.2500	76.200 3.0000	30.162 1.1875	94800 21300	0.33	1.80	24600 5520	14000 3140	1.76	102000 22800		3193	3129	
31.750 1.2500	76.200 3.0000	30.162 1.1875	94800 21300	0.33	1.80	24600 5520	14000 3140	1.76	102000 22800		3188	3129	
31.750 1.2500	79.375 3.1250	25.400 1.0000	92000 20700	0.67	0.90	23900 5360	27300 6130	0.87	76200 17100		43125	43312	
31.750 1.2500	79.375 3.1250	29.370 1.1563	105000 23500	0.37	1.64	27100 6100	17000 3820	1.60	119000 26800		3476	3420	
31.750 1.2500	80.000 3.1496	24.175 0.9518	94300 21200	0.27	2.20	24400 5490	11400 2570	2.14	83400 18700		346	332A	
31.750 1.2500	80.167 3.1562	26.988 1.0625	94300 21200	0.27	2.20	24400 5490	11400 2570	2.14	83400 18700		346	3320	
31.987 1.2593	66.987 2.6373	20.500 0.8071	63800 14300	0.42	1.44	16500 3720	11800 2650	1.40	70200 15800		02476X	02419	
31.987 1.2593	71.973 2.8336	27.000 1.0630	76800 17300	0.55	1.10	19900 4480	18600 4180	1.07	94200 21200		HM88638	HM88611	
32.000 1.2598	72.000 2.8346	19.000 0.7480	58800 13200	0.36	1.67	15200 3420	9390 2110	1.62	60100 13500		26126X	26283	
32.004 1.2600	72.000 2.8346	19.000 0.7480	58800 13200	0.36	1.67	15200 3420	9390 2110	1.62	60100 13500		26126	26283	

<sup>(1)</sup>Based on  $1 \times 10^6$  revolutions  $L_{10}$  life, for the ISO life-calculation method.

<sup>(2)</sup>Consult your Timken engineer for instructions on use or review the Timken Engineering Manual on [timken.com/catalogs](http://timken.com/catalogs).

<sup>(3)</sup>Based on  $90 \times 10^6$  revolutions  $L_{10}$  life, for The Timken Company life-calculation method.  $C_{90}$  and  $C_{a90}$  are radial and thrust values.



Bearing Dimensions											Geometry Factors			Bearing Weight
Width B	Width C	Eff. Ctr. a <sup>(4)</sup>	Shaft			Housing			Cage		G <sub>1</sub>	G <sub>2</sub>	C <sub>g</sub>	
			Max Shaft Fillet Radius R <sup>(5)</sup>	Backing Shoulder Dia. d <sub>a</sub> d <sub>b</sub>		Max Housing Fillet Radius r <sup>(5)</sup>	Backing Shoulder Dia. D <sub>a</sub> D <sub>b</sub>		A <sub>a</sub> <sup>(6)</sup>	A <sub>b</sub> <sup>(7)</sup>				
mm in.	mm in.	mm in.	mm in.	mm in.	mm in.	mm in.	mm in.	mm in.	mm in.	mm in.				kg lbs.
22.225 0.8750	17.462 0.6875	-3.8 -0.15	0.8 0.03	39.5 1.56	40.0 1.57	3.3 0.13	68.0 2.68	62.0 2.44	1.4 0.05	1.0 0.04	20.6	10.1	0.0740	0.44 0.99
23.812 0.9375	17.462 0.6875	-5.6 -0.22	0.8 0.03	38.5 1.52	39.5 1.56	3.3 0.13	68.0 2.68	63.0 2.48	0.9 0.03	0.2 0.01	23.1	12.4	0.0718	0.46 1.02
26.975 1.0620	22.225 0.8750	-8.1 -0.32	3.5 0.14	40.0 1.57	46.0 1.81	1.5 0.06	68.0 2.68	63.0 2.48	1.7 0.06	0.8 0.03	24.4	10.7	0.0734	0.55 1.22
27.783 1.0938	23.020 0.9063	-5.6 -0.22	1.3 0.05	42.6 1.68	45.5 1.79	3.3 0.13	70.0 2.76	59.0 2.32	1.9 0.07	1.8 0.08	26.3	8.7	0.0857	0.61 1.35
25.654 1.0100	19.050 0.7500	-8.1 -0.32	1.5 0.06	38.5 1.52	41.0 1.61	3.3 0.13	70.0 2.76	66.0 2.60	1.4 0.05	0.9 0.04	28.7	12.2	0.0725	0.57 1.25
24.074 0.9478	16.670 0.6563	-2.0 -0.08	1.5 0.06	41.5 1.63	44.0 1.73	3.3 0.13	73.0 2.87	64.0 2.52	3.4 0.13	2.4 0.10	16.8	7.6	0.0774	0.52 1.12
28.575 1.1250	23.020 0.9063	-5.6 -0.22	0.8 0.03	44.5 1.75	45.5 1.79	3.3 0.13	73.0 2.87	62.0 2.44	1.9 0.07	1.4 0.06	28.9	9.9	0.0883	0.68 1.50
29.997 1.1810	23.812 0.9375	-10.2 -0.40	3.5 0.14	39.5 1.56	45.5 1.79	0.8 0.03	69.0 2.72	65.0 2.56	1.5 0.06	0.6 0.02	23.4	8.8	0.0697	0.67 1.47
29.997 1.1810	23.812 0.9375	-10.2 -0.40	0.8 0.03	39.5 1.56	40.0 1.57	0.8 0.03	69.0 2.72	65.0 2.56	1.5 0.06	0.6 0.02	23.4	8.8	0.0697	0.67 1.48
24.074 0.9478	17.462 0.6875	-2.0 -0.08	1.5 0.06	41.5 1.63	44.0 1.73	1.5 0.06	74.0 2.91	67.0 2.64	3.4 0.13	2.4 0.10	16.8	7.6	0.0774	0.59 1.28
29.771 1.1721	23.812 0.9375	-8.6 -0.34	1.3 0.05	41.0 1.61	43.0 1.69	3.3 0.13	74.0 2.91	67.0 2.64	1.4 0.05	1.0 0.04	29.9	11.2	0.0781	0.74 1.64
22.403 0.8820	21.000 0.8268	-6.4 -0.25	0.8 0.03	39.5 1.56	40.0 1.57	2.3 0.09	75.0 2.95	71.0 2.80	0.7 0.02	1.1 0.05	26.5	13.0	0.0676	0.59 1.31
22.403 0.8820	23.812 0.9375	-6.4 -0.25	0.8 0.03	39.5 1.56	40.0 1.57	3.3 0.13	75.0 2.95	70.0 2.76	0.7 0.02	1.1 0.05	26.5	13.0	0.0676	0.62 1.38
20.500 0.8071	16.000 0.6299	-5.1 -0.20	0.8 0.03	38.5 1.52	39.5 1.56	1.5 0.06	62.0 2.44	59.0 2.32	1.1 0.04	2.7 0.11	17.5	8.5	0.0681	0.33 0.73
25.400 1.0000	21.443 0.8442	-4.6 -0.18	3.3 0.13	42.5 1.67	48.5 1.91	1.5 0.06	68.0 2.68	61.0 2.40	1.6 0.06	1.7 0.07	23.4	9.4	0.0822	0.54 1.21
18.923 0.7450	15.875 0.6250	-4.1 -0.16	2.0 0.08	37.5 1.48	40.5 1.59	1.5 0.06	65.0 2.56	62.0 2.44	0.5 0.02	1.1 0.05	16.1	10.1	0.0630	0.37 0.81
18.923 0.7450	15.875 0.6250	-4.1 -0.16	1.5 0.06	37.5 1.48	39.5 1.56	1.5 0.06	65.0 2.56	62.0 2.44	0.5 0.02	1.1 0.05	16.1	10.1	0.0630	0.37 0.81

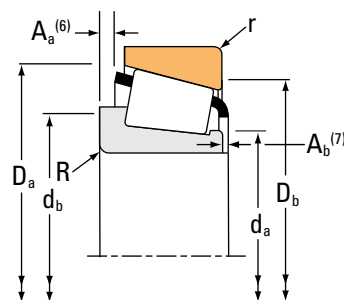
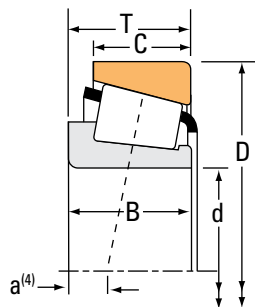
<sup>(4)</sup>Negative value indicates effective center inside cone (inner-ring) backface.  
<sup>(5)</sup>These maximum fillet radii will be cleared by the bearing corners.  
<sup>(6)</sup>Negative value indicates cage extends beyond cone (inner-ring) backface.  
<sup>(7)</sup>Negative value indicates cage that does not extend beyond cone (inner-ring) front face.

Continued on next page.

# TAPERED ROLLER BEARINGS

## SINGLE-ROW • TYPE TS

### TYPE TS



Bearing Dimensions			Load Ratings						Part Number			
Bore d	O.D. D	Width T	Dynamic <sup>(1)</sup>		Factors <sup>(2)</sup>		Dynamic <sup>(3)</sup>		Static		Inner	Outer
			C <sub>1</sub>	e	Y	C <sub>90</sub>	C <sub>a90</sub>	K	C <sub>0</sub>			
mm in.	mm in.	mm in.	N lbf			N lbf	N lbf		N lbf			
32.532 1.2808	69.850 2.7500	25.400 1.0000	83700 18800	0.27	2.19	21700 4880	10200 2280	2.14	94400 21200		2584	2523
33.337 1.3125	66.421 2.6150	25.400 1.0000	83700 18800	0.27	2.19	21700 4880	10200 2280	2.14	94400 21200		2585	2520
33.337 1.3125	66.675 2.6250	20.638 0.8125	52500 11800	0.37	1.62	13600 3060	8650 1950	1.57	57900 13000		1680	1620
33.337 1.3125	66.675 2.6250	20.638 0.8125	62400 14000	0.35	1.70	16200 3640	9770 2200	1.66	72800 16400	M38545		M38510
33.337 1.3125	68.262 2.6875	22.225 0.8750	66700 15000	0.28	2.18	17300 3890	8150 1830	2.12	77900 17500		16582	16522
33.337 1.3125	68.262 2.6875	22.225 0.8750	76300 17100	0.55	1.10	19800 4450	18500 4160	1.07	77400 17400	M88048		M88010
33.337 1.3125	68.262 2.6875	22.225 0.8750	76300 17100	0.55	1.10	19800 4450	18500 4160	1.07	77400 17400	M88048		M88012
33.337 1.3125	68.262 2.6875	22.225 0.8750	76300 17100	0.55	1.10	19800 4450	18500 4160	1.07	77400 17400	M88048A		M88010
33.337 1.3125	68.262 2.6875	22.225 0.8750	76300 17100	0.55	1.10	19800 4450	18500 4160	1.07	77400 17400	M88048-S		M88010
33.338 1.3125	69.012 2.7170	19.845 0.7813	54600 12300	0.38	1.57	14200 3180	9260 2080	1.53	61700 13900		14130	14274
33.338 1.3125	69.012 2.7170	19.845 0.7813	54600 12300	0.38	1.57	14200 3180	9260 2080	1.53	61700 13900		14131	14276
33.338 1.3125	69.012 2.7170	19.845 0.7813	54600 12300	0.38	1.57	14200 3180	9260 2080	1.53	61700 13900		14131	14274
33.338 1.3125	69.012 2.7170	19.845 0.7813	54600 12300	0.38	1.57	14200 3180	9260 2080	1.53	61700 13900		14130	14276
33.337 1.3125	69.723 2.7450	19.050 0.7500	69600 15700	0.36	1.67	18100 4060	11100 2500	1.62	60100 13500		26132	26274
33.337 1.3125	69.850 2.7500	23.812 0.9375	83700 18800	0.27	2.19	21700 4880	10200 2280	2.14	94400 21200		2585	2523
33.337 1.3125	69.850 2.7500	23.812 0.9375	83700 18800	0.27	2.19	21700 4880	10200 2280	2.14	94400 21200		2581	2523
33.337 1.3125	69.850 2.7500	23.812 0.9375	83700 18800	0.27	2.19	21700 4880	10200 2280	2.14	94400 21200		2585	2523-S

<sup>(1)</sup>Based on 1 x 10<sup>6</sup> revolutions L<sub>10</sub> life, for the ISO life-calculation method.

<sup>(2)</sup>Consult your Timken engineer for instructions on use or review the Timken Engineering Manual on timken.com/catalogs.

<sup>(3)</sup>Based on 90 x 10<sup>6</sup> revolutions L<sub>10</sub> life, for The Timken Company life-calculation method. C<sub>90</sub> and C<sub>a90</sub> are radial and thrust values.

Bearing Dimensions											Geometry Factors			Bearing Weight
Width B	Width C	Eff. Ctr. a <sup>(4)</sup>	Shaft			Housing			Cage		G <sub>1</sub>	G <sub>2</sub>	C <sub>g</sub>	
			Max Shaft Fillet Radius R <sup>(5)</sup>	Backing Shoulder Dia. d <sub>a</sub>	Shoulder Dia. d <sub>b</sub>	Max Housing Fillet Radius r <sup>(5)</sup>	Backing Shoulder Dia. D <sub>a</sub>	Shoulder Dia. D <sub>b</sub>	A <sub>a</sub> <sup>(6)</sup>	A <sub>b</sub> <sup>(7)</sup>				
mm in.	mm in.	mm in.	mm in.	mm in.	mm in.	mm in.	mm in.	mm in.	mm in.	mm in.				kg lbs.
26.944 1.0608	19.050 0.7500	-10.2 -0.40	5.0 0.20	38.0 1.50	47.5 1.87	1.3 0.05	64.0 2.52	61.0 2.40	2.4 0.09	0.8 0.04	23.6	9.6	0.0656	0.45 0.98
25.357 0.9983	20.638 0.8125	-8.6 -0.34	3.5 0.14	39.0 1.54	45.0 1.77	3.3 0.13	62.5 2.46	56.9 2.24	0.8 0.03	0.8 0.04	23.6	9.6	0.0656	0.39 0.85
20.638 0.8125	15.875 0.6250	-5.3 -0.21	3.5 0.14	38.5 1.52	44.5 1.75	1.5 0.06	61.0 2.40	58.0 2.28	* *	* *	16.6	8.7	0.0644	0.31 0.68
20.638 0.8125	16.670 0.6563	-5.6 -0.22	3.5 0.14	39.0 1.54	45.0 1.77	2.3 0.09	62.0 2.44	58.0 2.28	0.4 0.01	2.4 0.10	20.3	12.9	0.0680	0.32 0.71
22.225 0.8750	17.462 0.6875	-7.4 -0.29	1.5 0.06	38.5 1.52	41.0 1.61	0.8 0.03	63.0 2.48	61.0 2.40	0.6 0.02	1.6 0.06	22.7	13.0	0.0650	0.38 0.82
22.225 0.8750	17.462 0.6875	-2.8 -0.11	0.8 0.03	41.2 1.62	42.5 1.67	1.5 0.06	65.0 2.56	58.0 2.28	1.4 0.05	1.0 0.04	19.4	10.0	0.0771	0.38 0.84
22.225 0.8750	17.462 0.6875	-2.8 -0.11	0.8 0.03	41.2 1.62	42.5 1.67	0.8 0.03	64.0 2.52	59.0 2.32	1.4 0.05	1.0 0.04	19.4	10.0	0.0771	0.39 0.84
22.225 0.8750	17.462 0.6875	-2.8 -0.11	1.3 0.05	41.2 1.62	43.5 1.71	1.5 0.06	65.0 2.56	58.0 2.28	1.4 0.05	1.0 0.04	19.4	10.0	0.0771	0.38 0.84
22.225 0.8750	17.462 0.6875	-2.8 -0.11	4.0 0.16	41.2 1.62	49.5 1.95	1.5 0.06	65.0 2.56	58.0 2.28	1.4 0.05	1.0 0.04	19.4	10.0	0.0771	0.37 0.83
19.583 0.7710	15.875 0.6250	-4.3 -0.17	3.5 0.14	40.0 1.57	46.5 1.83	3.3 0.13	63.0 2.48	59.0 2.32	1.0 0.04	1.5 0.06	18.0	13.3	0.0668	0.33 0.74
19.583 0.7710	15.875 0.6250	-4.3 -0.17	0.8 0.03	40.0 1.57	41.0 1.61	1.3 0.05	63.0 2.48	60.0 2.36	1.0 0.04	1.5 0.06	18.0	13.3	0.0668	0.33 0.75
19.583 0.7710	15.875 0.6250	-4.3 -0.17	0.8 0.03	40.0 1.57	41.0 1.61	3.3 0.13	63.0 2.48	59.0 2.32	1.0 0.04	1.5 0.06	18.0	13.3	0.0668	0.33 0.73
19.583 0.7710	15.875 0.6250	-4.3 -0.17	3.5 0.14	40.0 1.57	46.5 1.83	1.3 0.05	63.0 2.48	60.0 2.36	1.0 0.04	1.5 0.06	18.0	13.3	0.0668	0.33 0.76
18.923 0.7450	19.050 0.7500	-4.1 -0.16	1.5 0.06	38.5 1.52	40.5 1.59	1.5 0.06	64.9 2.56	61.0 2.40	0.5 0.02	1.1 0.05	16.1	10.1	0.0630	0.34 0.76
25.357 0.9983	19.050 0.7500	-8.6 -0.34	3.5 0.14	39.0 1.54	45.0 1.77	1.3 0.05	64.0 2.52	61.0 2.40	0.8 0.03	0.8 0.04	23.6	9.6	0.0656	0.44 0.96
25.357 0.9983	19.050 0.7500	-8.6 -0.34	0.8 0.03	39.0 1.54	39.5 1.56	1.3 0.05	64.0 2.52	61.0 2.40	0.8 0.03	0.8 0.04	23.6	9.6	0.0656	0.44 0.96
25.357 0.9983	19.050 0.7500	-8.6 -0.34	3.5 0.14	39.0 1.54	45.0 1.77	1.5 0.06	64.0 2.52	61.0 2.40	0.8 0.03	0.8 0.04	23.6	9.6	0.0656	0.44 0.95

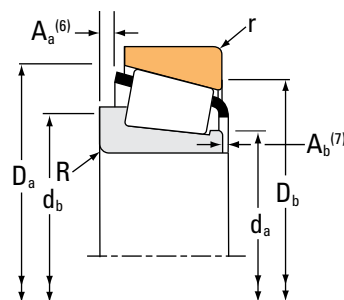
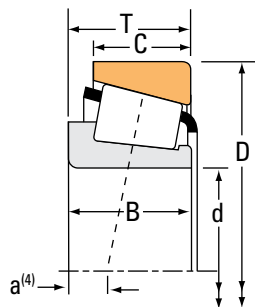
(4) Negative value indicates effective center inside cone (inner-ring) backface.  
 (5) These maximum fillet radii will be cleared by the bearing corners.  
 (6) Negative value indicates cage extends beyond cone (inner-ring) backface.  
 (7) Negative value indicates cage that does not extend beyond cone (inner-ring) front face.  
 (\*) Contact your Timken engineer for details.

Continued on next page.

# TAPERED ROLLER BEARINGS

## SINGLE-ROW • TYPE TS

### TYPE TS



Bearing Dimensions			Load Ratings							Part Number			
Bore d	O.D. D	Width T	Dynamic <sup>(1)</sup>		Factors <sup>(2)</sup>		Dynamic <sup>(3)</sup>		Factors <sup>(2)</sup>		Static C <sub>0</sub>	Inner	Outer
			C <sub>1</sub>	e	Y	C <sub>90</sub>	C <sub>a90</sub>	K	N	N			
mm in.	mm in.	mm in.	N lbf			N lbf	N lbf		N lbf				
33.337 1.3125	69.850 2.7500	23.812 0.9375	83700 18800	0.27	2.19	21700 4880	10200 2280	2.14	94400 21200		2581	2523-S	
33.338 1.3125	71.996 2.8345	19.002 0.7481	54600 12300	0.38	1.57	14200 3180	9260 2080	1.53	61700 13900		14130	14282	
33.337 1.3125	72.000 2.8346	19.000 0.7480	69600 15700	0.36	1.67	18100 4060	11100 2500	1.62	60100 13500		26131	26283	
33.337 1.3125	72.000 2.8346	19.000 0.7480	69600 15700	0.36	1.67	18100 4060	11100 2500	1.62	60100 13500		26131	26283-S	
33.337 1.3125	72.238 2.8440	20.638 0.8125	56600 12700	0.40	1.49	14700 3300	10100 2270	1.45	65800 14800		16131	16284	
33.337 1.3125	72.625 2.8593	30.162 1.1875	94800 21300	0.33	1.80	24600 5520	14000 3140	1.76	102000 22800		3197	3120	
33.337 1.3125	72.625 2.8593	30.162 1.1875	94800 21300	0.33	1.80	24600 5520	14000 3140	1.76	102000 22800		3196	3120	
33.337 1.3125	73.025 2.8750	23.812 0.9375	86900 19500	0.30	1.98	22500 5060	11700 2630	1.93	102000 23000		2790	2735X	
33.337 1.3125	73.025 2.8750	29.370 1.1563	103000 23200	0.55	1.10	26700 6010	25000 5620	1.07	111000 24900		HM88547	HM88510	
33.337 1.3125	73.025 2.8750	29.370 1.1563	103000 23200	0.55	1.10	26700 6010	25000 5620	1.07	111000 24900		HM88547	HM88511	
33.337 1.3125	73.812 2.9060	29.370 1.1563	103000 23200	0.55	1.10	26700 6010	25000 5620	1.07	111000 24900		HM88547	HM88512	
33.337 1.3125	76.200 3.0000	22.225 0.8750	76300 17100	0.55	1.10	19800 4450	18500 4160	1.07	77400 17400		M88048	M88022	
33.337 1.3125	76.200 3.0000	23.812 0.9375	86900 19500	0.30	1.98	22500 5060	11700 2630	1.93	102000 23000		2790	2729	
33.337 1.3125	76.200 3.0000	23.812 0.9375	86900 19500	0.30	1.98	22500 5060	11700 2630	1.93	102000 23000		2785	2729	
33.337 1.3125	76.200 3.0000	23.812 0.9375	86900 19500	0.30	1.98	22500 5060	11700 2630	1.93	102000 23000		2790	2720	
33.337 1.3125	76.200 3.0000	23.812 0.9375	86900 19500	0.30	1.98	22500 5060	11700 2630	1.93	102000 23000		2785	2720	
33.337 1.3125	76.200 3.0000	29.370 1.1563	94700 21300	0.40	1.49	24600 5520	16900 3800	1.45	107000 24100		31590	31520	

<sup>(1)</sup>Based on 1 x 10<sup>6</sup> revolutions L<sub>10</sub> life, for the ISO life-calculation method.

<sup>(2)</sup>Consult your Timken engineer for instructions on use or review the Timken Engineering Manual on timken.com/catalogs.

<sup>(3)</sup>Based on 90 x 10<sup>6</sup> revolutions L<sub>10</sub> life, for The Timken Company life-calculation method. C<sub>90</sub> and C<sub>a90</sub> are radial and thrust values.

Bearing Dimensions											Geometry Factors			Bearing Weight
Width B	Width C	Eff. Ctr. a <sup>(4)</sup>	Shaft			Housing			Cage		G <sub>1</sub>	G <sub>2</sub>	C <sub>g</sub>	
			Max Shaft Fillet Radius R <sup>(5)</sup>	Backing Shoulder Dia. d <sub>a</sub>	Shoulder Dia. d <sub>b</sub>	Max Housing Fillet Radius r <sup>(5)</sup>	Backing Shoulder Dia. D <sub>a</sub>	Shoulder Dia. D <sub>b</sub>	A <sub>a</sub> <sup>(6)</sup>	A <sub>b</sub> <sup>(7)</sup>				
mm in.	mm in.	mm in.	mm in.	mm in.	mm in.	mm in.	mm in.	mm in.	mm in.	mm in.				kg lbs.
25.357 0.9983	19.050 0.7500	-8.6 -0.34	0.8 0.03	39.0 1.54	39.5 1.56	1.5 0.06	64.0 2.52	61.0 2.40	0.8 0.03	0.8 0.04	23.6	9.6	0.0656	0.44 0.96
19.583 0.7710	15.032 0.5918	-4.3 -0.17	3.5 0.14	40.0 1.57	46.5 1.83	1.5 0.06	65.0 2.56	62.0 2.44	1.0 0.04	1.5 0.06	18.0	13.3	0.0668	0.36 0.82
18.923 0.7450	15.875 0.6250	-4.1 -0.16	3.5 0.14	38.5 1.52	44.5 1.75	1.5 0.06	65.0 2.56	62.0 2.44	0.5 0.02	1.1 0.05	16.1	10.1	0.0630	0.35 0.78
18.923 0.7450	15.875 0.6250	-4.1 -0.16	3.5 0.14	38.5 1.52	44.5 1.75	2.0 0.08	65.0 2.56	62.0 2.44	0.5 0.02	1.1 0.05	16.1	10.1	0.0630	0.35 0.78
20.638 0.8125	15.875 0.6250	-4.1 -0.16	3.5 0.14	39.5 1.56	46.0 1.81	1.3 0.05	67.0 2.64	63.0 2.48	1.1 0.04	1.1 0.05	20.3	14.5	0.0707	0.39 0.87
29.997 1.1810	23.812 0.9375	-10.2 -0.40	0.8 0.03	40.5 1.59	41.5 1.63	3.3 0.13	67.0 2.64	61.0 2.40	* *	* *	23.4	8.8	0.0697	0.57 1.25
29.997 1.1810	23.812 0.9375	-10.2 -0.40	3.5 0.14	40.5 1.59	47.0 1.85	3.3 0.13	67.0 2.64	61.0 2.40	1.5 0.06	0.6 0.02	23.4	8.8	0.0697	0.57 1.23
25.654 1.0100	19.050 0.7500	-8.1 -0.32	1.5 0.06	40.0 1.57	42.0 1.65	0.8 0.03	69.0 2.72	66.0 2.60	1.4 0.05	0.9 0.04	28.7	12.2	0.0725	0.51 1.12
27.783 1.0938	23.020 0.9063	-5.6 -0.22	0.8 0.03	42.6 1.68	45.5 1.79	3.3 0.13	70.0 2.76	59.0 2.32	1.9 0.07	1.8 0.08	26.3	8.7	0.0857	0.60 1.31
27.783 1.0938	23.020 0.9063	-5.6 -0.22	0.8 0.03	42.6 1.68	45.5 1.79	0.8 0.03	70.0 2.76	62.0 2.44	1.9 0.07	1.8 0.08	26.3	8.7	0.0857	0.60 1.32
27.783 1.0938	23.020 0.9063	-5.6 -0.22	0.8 0.03	42.6 1.68	45.5 1.79	3.3 0.13	70.0 2.76	60.0 2.36	1.9 0.07	1.8 0.08	26.3	8.7	0.0857	0.61 1.34
22.225 0.8750	17.462 0.6875	-2.8 -0.11	0.8 0.03	41.2 1.62	42.5 1.67	0.8 0.03	68.0 2.68	62.0 2.44	1.4 0.05	1.0 0.04	19.4	10.0	0.0771	0.51 1.11
25.654 1.0100	19.050 0.7500	-8.1 -0.32	1.5 0.06	40.0 1.57	42.0 1.65	0.8 0.03	70.0 2.76	68.0 2.68	1.4 0.05	0.9 0.04	28.7	12.2	0.0725	0.57 1.24
25.654 1.0100	19.050 0.7500	-8.1 -0.32	3.5 0.14	40.0 1.57	46.0 1.81	0.8 0.03	70.0 2.76	68.0 2.68	1.4 0.05	0.9 0.04	28.7	12.2	0.0725	0.56 1.23
25.654 1.0100	19.050 0.7500	-8.1 -0.32	1.5 0.06	40.0 1.57	42.0 1.65	3.3 0.13	70.0 2.76	66.0 2.60	1.4 0.05	0.9 0.04	28.7	12.2	0.0725	0.56 1.22
25.654 1.0100	19.050 0.7500	-8.1 -0.32	3.5 0.14	40.0 1.57	46.0 1.81	3.3 0.13	70.0 2.76	66.0 2.60	1.4 0.05	0.9 0.04	28.7	12.2	0.0725	0.55 1.21
28.575 1.1250	23.812 0.9375	-7.6 -0.30	0.8 0.03	42.5 1.67	43.0 1.69	3.3 0.13	72.0 2.83	64.0 2.52	1.6 0.06	1.3 0.05	26.3	9.1	0.0773	0.64 1.41

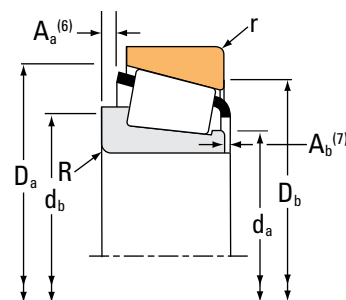
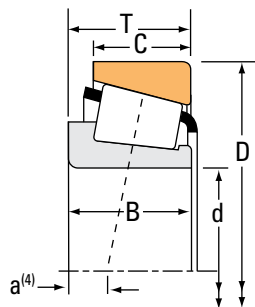
(4) Negative value indicates effective center inside cone (inner-ring) backface.  
 (5) These maximum fillet radii will be cleared by the bearing corners.  
 (6) Negative value indicates cage extends beyond cone (inner-ring) backface.  
 (7) Negative value indicates cage that does not extend beyond cone (inner-ring) front face.  
 (\*) Contact your Timken engineer for details.

Continued on next page.

# TAPERED ROLLER BEARINGS

## SINGLE-ROW • TYPE TS

### TYPE TS



Bearing Dimensions			Load Ratings							Part Number		
Bore d	O.D. D	Width T	Dynamic <sup>(1)</sup>		Factors <sup>(2)</sup>		Dynamic <sup>(3)</sup>		Factors <sup>(2)</sup>	Static	Inner	Outer
			C <sub>1</sub>	e	Y	C <sub>90</sub>	C <sub>a90</sub>	K	C <sub>0</sub>			
mm in.	mm in.	mm in.	N lbf			N lbf	N lbf			N lbf		
33.337 1.3125	76.200 3.0000	29.370 1.1563	110000 24800	0.55	1.10	28600 6440	26800 6020	1.07		119000 26700	HM89443	HM89410
33.337 1.3125	76.200 3.0000	29.370 1.1563	110000 24800	0.55	1.10	28600 6440	26800 6020	1.07		119000 26700	HM89444	HM89410
33.337 1.3125	76.200 3.0000	29.370 1.1563	110000 24800	0.55	1.10	28600 6440	26800 6020	1.07		119000 26700	HM89443	HM89411
33.337 1.3125	79.375 3.1250	25.400 1.0000	92000 20700	0.67	0.90	23900 5360	27300 6130	0.87		76200 17100	43131	43312
33.337 1.3125	79.375 3.1250	25.400 1.0000	92000 20700	0.67	0.90	23900 5360	27300 6130	0.87		76200 17100	43132	43312
33.337 1.3125	79.375 3.1250	29.370 1.1563	105000 23500	0.37	1.64	27100 6100	17000 3820	1.60		119000 26800	3477	3420
33.337 1.3125	79.375 3.1250	29.370 1.1563	105000 23500	0.37	1.64	27100 6100	17000 3820	1.60		119000 26800	3483	3420
33.337 1.3125	80.000 3.1496	21.000 0.8268	94300 21200	0.27	2.20	24400 5490	11400 2570	2.14		83400 18700	335-S	332
33.337 1.3125	80.167 3.1562	26.988 1.0625	94300 21200	0.27	2.20	24400 5490	11400 2570	2.14		83400 18700	335-S	3320
33.337 1.3125	88.500 3.4843	25.400 1.0000	99800 22400	0.78	0.77	25900 5810	34600 7770	0.75		88600 19900	44131	44348
34.925 1.3750	65.088 2.5625	18.034 0.7100	64600 14500	0.38	1.59	16700 3760	10800 2430	1.55		63100 14200	LM48548	LM48510
34.925 1.3750	65.088 2.5625	18.034 0.7100	64600 14500	0.38	1.59	16700 3760	10800 2430	1.55		63100 14200	LM48549X	LM48510
34.925 1.3750	65.088 2.5625	18.034 0.7100	64600 14500	0.38	1.59	16700 3760	10800 2430	1.55		63100 14200	LM48549	LM48510
34.925 1.3750	65.088 2.5625	18.034 0.7100	64600 14500	0.38	1.59	16700 3760	10800 2430	1.55		63100 14200	LM48548A	LM48510
34.925 1.3750	65.088 2.5625	21.082 0.8300	64600 14500	0.38	1.59	16700 3760	10800 2430	1.55		63100 14200	LM48548A	LM48511A
34.925 1.3750	65.088 2.5625	21.082 0.8300	64600 14500	0.38	1.59	16700 3760	10800 2430	1.55		63100 14200	LM48548	LM48511A
34.925 1.3750	65.987 2.5979	20.638 0.8125	62400 14000	0.35	1.70	16200 3640	9770 2200	1.66		72800 16400	M38549	M38511

<sup>(1)</sup>Based on  $1 \times 10^6$  revolutions  $L_{10}$  life, for the ISO life-calculation method.

<sup>(2)</sup>Consult your Timken engineer for instructions on use or review the Timken Engineering Manual on [timken.com/catalogs](http://timken.com/catalogs).

<sup>(3)</sup>Based on  $90 \times 10^6$  revolutions  $L_{10}$  life, for The Timken Company life-calculation method.  $C_{90}$  and  $C_{a90}$  are radial and thrust values.

Bearing Dimensions											Geometry Factors			Bearing Weight
Width B	Width C	Eff. Ctr. a <sup>(4)</sup>	Shaft			Housing			Cage		G <sub>1</sub>	G <sub>2</sub>	C <sub>g</sub>	
			Max Shaft Fillet Radius R <sup>(5)</sup>	Backing Shoulder Dia. d <sub>a</sub>	Backing Shoulder Dia. d <sub>b</sub>	Max Housing Fillet Radius r <sup>(5)</sup>	Backing Shoulder Dia. D <sub>a</sub>	Backing Shoulder Dia. D <sub>b</sub>	A <sub>a</sub> <sup>(6)</sup>	A <sub>b</sub> <sup>(7)</sup>				
mm in.	mm in.	mm in.	mm in.	mm in.	mm in.	mm in.	mm in.	mm in.	mm in.	mm in.				kg lbs.
28.575 1.1250	23.020 0.9063	-5.6 -0.22	0.8 0.03	44.5 1.75	46.5 1.83	3.3 0.13	73.0 2.87	62.0 2.44	1.9 0.07	1.4 0.06	28.9	9.9	0.0883	0.66 1.46
28.575 1.1250	23.020 0.9063	-5.6 -0.22	3.8 0.15	44.5 1.75	53.0 2.09	3.3 0.13	73.0 2.87	62.0 2.44	1.9 0.07	1.4 0.06	28.9	9.9	0.0883	0.65 1.45
28.575 1.1250	23.020 0.9063	-5.6 -0.22	0.8 0.03	44.5 1.75	46.5 1.83	0.8 0.03	73.0 2.87	65.0 2.56	1.9 0.07	1.4 0.06	28.9	9.9	0.0883	0.67 1.48
24.074 0.9478	17.462 0.6875	-2.0 -0.08	3.5 0.14	42.1 1.65	51.0 2.01	1.5 0.06	74.0 2.91	67.0 2.64	3.4 0.13	2.4 0.10	16.8	7.6	0.0774	0.57 1.24
24.074 0.9478	17.462 0.6875	-2.0 -0.08	2.0 0.08	42.1 1.65	48.0 1.89	1.5 0.06	74.0 2.91	67.0 2.64	3.4 0.13	2.4 0.10	16.8	7.6	0.0774	0.57 1.25
29.771 1.1721	23.812 0.9375	-8.6 -0.34	3.5 0.14	42.5 1.67	49.0 1.93	3.3 0.13	74.0 2.91	67.0 2.64	1.4 0.05	1.0 0.04	29.9	11.2	0.0781	0.71 1.58
29.771 1.1721	23.812 0.9375	-8.6 -0.34	0.8 0.03	42.5 1.67	43.0 1.69	3.3 0.13	74.0 2.91	67.0 2.64	1.4 0.05	1.0 0.04	29.9	11.2	0.0781	0.72 1.59
22.403 0.8820	17.826 0.7018	-6.4 -0.25	0.8 0.03	40.5 1.59	41.0 1.61	1.3 0.05	75.0 2.95	73.0 2.87	0.7 0.02	1.1 0.05	26.5	13.0	0.0676	0.54 1.20
22.403 0.8820	23.812 0.9375	-6.4 -0.25	0.8 0.03	40.5 1.59	41.0 1.61	3.3 0.13	75.0 2.95	70.0 2.76	0.7 0.02	1.1 0.05	26.5	13.0	0.0676	0.61 1.35
23.698 0.9330	17.462 0.6875	2.3 0.09	2.0 0.08	48.0 1.89	51.0 2.01	1.5 0.06	84.0 3.31	75.0 2.95	3.8 0.15	2.7 0.11	22.9	8.7	0.0899	0.76 1.67
18.288 0.7200	13.970 0.5500	-3.6 -0.14	3.5 0.14	41.5 1.63	48.0 1.89	1.3 0.05	61.0 2.40	58.0 2.28	0.7 0.02	1.3 0.05	18.0	10.6	0.0666	0.25 0.54
18.288 0.7200	13.970 0.5500	-3.6 -0.14	2.3 0.09	40.0 1.57	43.5 1.71	1.3 0.05	61.0 2.40	58.0 2.28	0.8 0.03	1.1 0.05	18.0	10.6	0.0666	0.26 0.55
18.288 0.7200	13.970 0.5500	-3.6 -0.14	1.5 0.06	40.0 1.57	42.0 1.65	1.3 0.05	61.0 2.40	58.0 2.28	0.8 0.03	1.1 0.05	18.0	10.6	0.0666	0.26 0.56
18.288 0.7200	13.970 0.5500	-3.6 -0.14	0.8 0.03	42.2 1.66	40.5 1.59	1.3 0.05	61.0 2.40	58.0 2.28	0.7 0.02	1.3 0.05	18.0	10.6	0.0666	0.26 0.56
18.288 0.7200	17.018 0.6700	-3.6 -0.14	0.8 0.03	42.2 1.66	40.5 1.59	1.5 0.06	61.0 2.40	58.0 2.28	0.7 0.02	1.3 0.05	18.0	10.6	0.0666	0.28 0.61
18.288 0.7200	17.018 0.6700	-3.6 -0.14	3.5 0.14	41.5 1.63	48.0 1.89	1.5 0.06	61.0 2.40	58.0 2.28	0.7 0.02	1.3 0.05	18.0	10.6	0.0666	0.27 0.59
20.638 0.8125	16.670 0.6563	-5.6 -0.22	3.5 0.14	40.0 1.57	46.5 1.83	2.3 0.09	62.0 2.44	58.0 2.28	0.4 0.01	2.4 0.10	20.3	12.9	0.0680	0.30 0.66

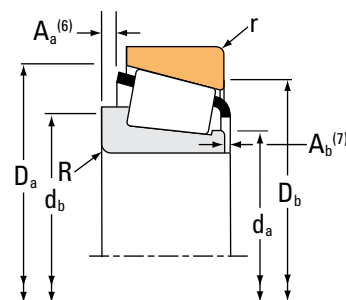
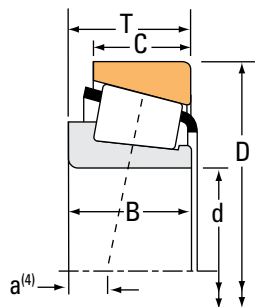
(4) Negative value indicates effective center inside cone (inner-ring) backface.  
 (5) These maximum fillet radii will be cleared by the bearing corners.  
 (6) Negative value indicates cage extends beyond cone (inner-ring) backface.  
 (7) Negative value indicates cage that does not extend beyond cone (inner-ring) front face.

Continued on next page.

# TAPERED ROLLER BEARINGS

## SINGLE-ROW • TYPE TS

### TYPE TS



Bearing Dimensions			Load Ratings						Part Number				
Bore d	O.D. D	Width T	Dynamic <sup>(1)</sup>		Factors <sup>(2)</sup>		Dynamic <sup>(3)</sup>		Factors <sup>(2)</sup>		Static C <sub>0</sub>	Inner	Outer
			C <sub>1</sub>	e	Y	C <sub>90</sub>	C <sub>a90</sub>	K					
mm in.	mm in.	mm in.	N lbf			N lbf	N lbf		N lbf				
34.925 1.3750	66.675 2.6250	20.638 0.8125	62400 14000	0.35	1.70	16200 3640	9770 2200	1.66	72800 16400		M38549	M38510	
34.925 1.3750	68.262 2.6875	18.034 0.7100	64600 14500	0.38	1.59	16700 3760	10800 2430	1.55	63100 14200		LM48548	LM48514	
34.925 1.3750	68.262 2.6875	20.638 0.8125	59200 13300	0.35	1.70	15400 3450	9270 2080	1.66	68100 15300		14585	14525	
34.925 1.3750	68.262 2.6875	20.638 0.8125	62400 14000	0.35	1.70	16200 3640	9770 2200	1.66	72800 16400		M38549	M38514	
34.925 1.3750	69.012 2.7170	19.845 0.7813	54600 12300	0.38	1.57	14200 3180	9260 2080	1.53	61700 13900		14138A	14274	
34.925 1.3750	69.012 2.7170	19.845 0.7813	54600 12300	0.38	1.57	14200 3180	9260 2080	1.53	61700 13900		14137A	14276	
34.925 1.3750	69.012 2.7170	19.845 0.7813	54600 12300	0.38	1.57	14200 3180	9260 2080	1.53	61700 13900		14138A	14276	
34.925 1.3750	69.012 2.7170	19.845 0.7813	54600 12300	0.38	1.57	14200 3180	9260 2080	1.53	61700 13900		14137A	14274	
34.925 1.3750	69.012 2.7170	22.385 0.8813	54600 12300	0.38	1.57	14200 3180	9260 2080	1.53	61700 13900		14138A	14277	
34.925 1.3750	69.850 2.7500	19.845 0.7813	54600 12300	0.38	1.57	14200 3180	9260 2080	1.53	61700 13900		14137A	14275A	
34.925 1.3750	71.973 2.8336	27.000 1.0630	76800 17300	0.55	1.10	19900 4480	18600 4180	1.07	94200 21200		HM88649	HM88611	
34.925 1.3750	72.233 2.8438	25.400 1.0000	76800 17300	0.55	1.10	19900 4480	18600 4180	1.07	94200 21200		HM88649	HM88610	
34.925 1.3750	72.233 2.8438	25.400 1.0000	76800 17300	0.55	1.10	19900 4480	18600 4180	1.07	94200 21200		HM88649A	HM88610	
34.925 1.3750	72.238 2.8440	20.638 0.8125	56600 12700	0.40	1.49	14700 3300	10100 2270	1.45	65800 14800		16137	16284	
34.925 1.3750	72.625 2.8593	25.400 1.0000	76800 17300	0.55	1.10	19900 4480	18600 4180	1.07	94200 21200		HM88649	HM88611AS	
34.925 1.3750	73.025 2.8750	22.225 0.8750	73200 16400	0.37	1.63	19000 4260	12000 2690	1.59	83800 18800		2877	2820	
34.925 1.3750	73.025 2.8750	22.225 0.8750	65700 14800	0.45	1.32	17000 3830	13200 2980	1.29	74900 16800		02877	02820	

<sup>(1)</sup>Based on 1 x 10<sup>6</sup> revolutions L<sub>10</sub> life, for the ISO life-calculation method.

<sup>(2)</sup>Consult your Timken engineer for instructions on use or review the Timken Engineering Manual on timken.com/catalogs.

<sup>(3)</sup>Based on 90 x 10<sup>6</sup> revolutions L<sub>10</sub> life, for The Timken Company life-calculation method. C<sub>90</sub> and C<sub>a90</sub> are radial and thrust values.



Bearing Dimensions											Geometry Factors			Bearing Weight
Width B	Width C	Eff. Ctr. a <sup>(4)</sup>	Shaft			Housing			Cage		G <sub>1</sub>	G <sub>2</sub>	C <sub>g</sub>	
			Max Shaft Fillet Radius R <sup>(5)</sup>	Backing Shoulder Dia. d <sub>a</sub>	Backing Shoulder Dia. d <sub>b</sub>	Max Housing Fillet Radius r <sup>(5)</sup>	Backing Shoulder Dia. D <sub>a</sub>	Backing Shoulder Dia. D <sub>b</sub>	A <sub>a</sub> <sup>(6)</sup>	A <sub>b</sub> <sup>(7)</sup>				
mm in.	mm in.	mm in.	mm in.	mm in.	mm in.	mm in.	mm in.	mm in.	mm in.	mm in.				kg lbs.
20.638 0.8125	16.670 0.6563	-5.6 -0.22	3.5 0.14	40.0 1.57	46.5 1.83	2.3 0.09	62.0 2.44	58.0 2.28	0.4 0.01	2.4 0.10	20.3	12.9	0.0680	0.31 0.68
18.288 0.7200	13.970 0.5500	-3.6 -0.14	3.5 0.14	41.5 1.63	48.0 1.89	1.3 0.05	63.0 2.48	59.0 2.32	0.7 0.02	1.3 0.05	18.0	10.6	0.0666	0.28 0.62
20.638 0.8125	15.875 0.6250	-5.8 -0.23	3.5 0.14	40.0 1.57	46.0 1.81	2.3 0.09	63.0 2.48	59.0 2.32	0.7 0.03	2.2 0.09	19.5	12.3	0.0670	0.32 0.71
20.638 0.8125	16.670 0.6563	-5.6 -0.22	3.5 0.14	40.0 1.57	46.5 1.83	2.3 0.09	63.0 2.48	59.0 2.32	0.4 0.01	2.4 0.10	20.3	12.9	0.0680	0.33 0.73
19.583 0.7710	15.875 0.6250	-4.3 -0.17	3.5 0.14	41.5 1.63	48.0 1.89	3.3 0.13	63.0 2.48	59.0 2.32	1.0 0.04	1.5 0.06	18.0	13.3	0.0668	0.32 0.70
19.583 0.7710	15.875 0.6250	-4.3 -0.17	1.5 0.06	41.5 1.63	43.5 1.71	1.3 0.05	63.0 2.48	60.0 2.36	1.0 0.04	1.5 0.06	18.0	13.3	0.0668	0.32 0.72
19.583 0.7710	15.875 0.6250	-4.3 -0.17	3.5 0.14	41.5 1.63	48.0 1.89	1.3 0.05	63.0 2.48	60.0 2.36	1.0 0.04	1.5 0.06	18.0	13.3	0.0668	0.32 0.71
19.583 0.7710	15.875 0.6250	-4.3 -0.17	1.5 0.06	41.5 1.63	43.5 1.71	3.3 0.13	63.0 2.48	59.0 2.32	1.0 0.04	1.5 0.06	18.0	13.3	0.0668	0.32 0.70
19.583 0.7710	18.415 0.7250	-4.3 -0.17	3.5 0.14	41.5 1.63	48.0 1.89	2.3 0.09	63.0 2.48	59.0 2.32	1.0 0.04	1.5 0.06	18.0	13.3	0.0668	0.35 0.77
19.583 0.7710	15.875 0.6250	-4.3 -0.17	1.5 0.06	41.5 1.63	43.5 1.71	1.5 0.06	64.0 2.52	60.0 2.36	1.0 0.04	1.5 0.06	18.0	13.3	0.0668	0.33 0.74
25.400 1.0000	21.443 0.8442	-4.6 -0.18	2.3 0.09	42.5 1.68	48.5 1.91	1.5 0.06	68.0 2.68	61.0 2.40	1.6 0.06	1.7 0.07	23.4	9.4	0.0822	0.51 1.14
25.400 1.0000	19.842 0.7812	-4.6 -0.18	2.3 0.09	42.5 1.68	48.5 1.91	2.3 0.09	69.0 2.72	60.0 2.36	1.6 0.06	1.7 0.07	23.4	9.4	0.0822	0.48 1.08
25.400 1.0000	19.842 0.7812	-4.6 -0.18	3.5 0.14	43.0 1.69	51.0 2.01	2.3 0.09	69.0 2.72	60.0 2.36	1.6 0.06	1.7 0.07	23.4	9.4	0.0822	0.48 1.07
20.638 0.8125	15.875 0.6250	-4.1 -0.16	3.5 0.14	40.5 1.59	47.0 1.85	1.3 0.05	67.0 2.64	63.0 2.48	1.1 0.04	1.1 0.05	20.3	14.5	0.0707	0.38 0.84
25.400 1.0000	19.842 0.7812	-4.6 -0.18	2.3 0.09	42.5 1.68	48.5 1.91	3.3 0.13	69.0 2.72	59.0 2.32	1.6 0.06	1.7 0.07	23.4	9.4	0.0822	0.49 1.08
23.812 0.9375	17.462 0.6875	-5.6 -0.22	3.5 0.14	41.0 1.61	47.5 1.87	3.3 0.13	68.0 2.68	63.0 2.48	0.9 0.03	0.2 0.01	23.1	12.4	0.0718	0.42 0.94
22.225 0.8750	17.462 0.6875	-3.8 -0.15	3.5 0.14	42.0 1.65	48.5 1.91	3.3 0.13	68.0 2.68	62.0 2.44	1.4 0.05	1.0 0.04	20.6	10.1	0.0740	0.41 0.91

<sup>(4)</sup>Negative value indicates effective center inside cone (inner-ring) backface.

<sup>(5)</sup>These maximum fillet radii will be cleared by the bearing corners.

<sup>(6)</sup>Negative value indicates cage extends beyond cone (inner-ring) backface.

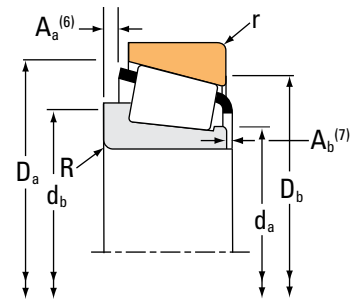
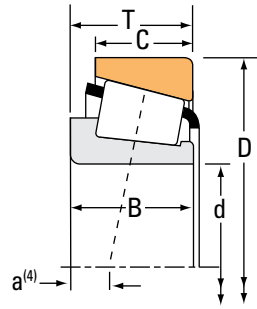
<sup>(7)</sup>Negative value indicates cage that does not extend beyond cone (inner-ring) front face.

Continued on next page.

# TAPERED ROLLER BEARINGS

## SINGLE-ROW • TYPE TS

### TYPE TS



Bearing Dimensions			Load Ratings							Part Number		
Bore d	O.D. D	Width T	Dynamic <sup>(1)</sup>		Factors <sup>(2)</sup>		Dynamic <sup>(3)</sup>		Factors <sup>(2)</sup>	Static	Inner	Outer
			C <sub>1</sub>	e	Y	C <sub>90</sub>	C <sub>a90</sub>	K	C <sub>0</sub>			
mm in.	mm in.	mm in.	N lbf			N lbf	N lbf			N lbf		
34.925 1.3750	73.025 2.8750	22.225 0.8750	73200 16400	0.37	1.63	19000 4260	12000 2690	1.59	83800 18800	2878	2820	
34.925 1.3750	73.025 2.8750	22.225 0.8750	65700 14800	0.45	1.32	17000 3830	13200 2980	1.29	74900 16800	02878	02830	
34.925 1.3750	73.025 2.8750	22.225 0.8750	73200 16400	0.37	1.63	19000 4260	12000 2690	1.59	83800 18800	2878	2821	
34.925 1.3750	73.025 2.8750	22.225 0.8750	65700 14800	0.45	1.32	17000 3830	13200 2980	1.29	74900 16800	02878	02820	
34.925 1.3750	73.025 2.8750	23.812 0.9375	85100 19100	0.29	2.07	22100 4960	11000 2460	2.01	97400 21900	25877	25820	
34.925 1.3750	73.025 2.8750	23.812 0.9375	85100 19100	0.29	2.07	22100 4960	11000 2460	2.01	97400 21900	25877	25821	
34.925 1.3750	73.025 2.8750	23.812 0.9375	85100 19100	0.29	2.07	22100 4960	11000 2460	2.01	97400 21900	25878	25821	
34.925 1.3750	73.025 2.8750	23.812 0.9375	85100 19100	0.29	2.07	22100 4960	11000 2460	2.01	97400 21900	25878	25820	
34.925 1.3750	73.025 2.8750	23.812 0.9375	86900 19500	0.30	1.98	22500 5060	11700 2630	1.93	102000 23000	2793	2735X	
34.925 1.3750	73.025 2.8750	23.812 0.9375	86900 19500	0.30	1.98	22500 5060	11700 2630	1.93	102000 23000	2786	2735X	
34.925 1.3750	73.025 2.8750	23.812 0.9375	85100 19100	0.29	2.07	22100 4960	11000 2460	2.01	97400 21900	25877A	25821	
34.925 1.3750	73.025 2.8750	26.988 1.0625	89400 20100	0.37	1.62	23200 5210	14700 3300	1.58	102000 22900	23690	23620	
34.925 1.3750	76.200 3.0000	23.812 0.9375	86900 19500	0.30	1.98	22500 5060	11700 2630	1.93	102000 23000	2793	2720	
34.925 1.3750	76.200 3.0000	23.812 0.9375	86900 19500	0.30	1.98	22500 5060	11700 2630	1.93	102000 23000	2786	2729	
34.925 1.3750	76.200 3.0000	23.812 0.9375	86900 19500	0.30	1.98	22500 5060	11700 2630	1.93	102000 23000	2786	2720	
34.925 1.3750	76.200 3.0000	23.812 0.9375	86900 19500	0.30	1.98	22500 5060	11700 2630	1.93	102000 23000	2793	2729	
34.925 1.3750	76.200 3.0000	23.812 0.9375	86900 19500	0.30	1.98	22500 5060	11700 2630	1.93	102000 23000	2796	2729	

<sup>(1)</sup>Based on 1 x 10<sup>6</sup> revolutions L<sub>10</sub> life, for the ISO life-calculation method.

<sup>(2)</sup>Consult your Timken engineer for instructions on use or review the Timken Engineering Manual on timken.com/catalogs.

<sup>(3)</sup>Based on 90 x 10<sup>6</sup> revolutions L<sub>10</sub> life, for The Timken Company life-calculation method. C<sub>90</sub> and C<sub>a90</sub> are radial and thrust values.

Bearing Dimensions											Geometry Factors			Bearing Weight
Width B	Width C	Eff. Ctr. a <sup>(4)</sup>	Shaft			Housing			Cage		G <sub>1</sub>	G <sub>2</sub>	C <sub>g</sub>	
			Max Shaft Fillet Radius R <sup>(5)</sup>	Backing Shoulder Dia. d <sub>a</sub>	Backing Shoulder Dia. d <sub>b</sub>	Max Housing Fillet Radius r <sup>(5)</sup>	Backing Shoulder Dia. D <sub>a</sub>	Backing Shoulder Dia. D <sub>b</sub>	A <sub>a</sub> <sup>(6)</sup>	A <sub>b</sub> <sup>(7)</sup>				
mm in.	mm in.	mm in.	mm in.	mm in.	mm in.	mm in.	mm in.	mm in.	mm in.	mm in.				kg lbs.
23.812 0.9375	17.462 0.6875	-5.6 -0.22	0.8 0.03	41.0 1.61	42.0 1.65	3.3 0.13	68.0 2.68	63.0 2.48	0.9 0.03	0.2 0.01	23.1	12.4	0.0718	0.43 0.96
22.225 0.8750	17.462 0.6875	-3.8 -0.15	0.8 0.03	42.0 1.65	42.5 1.67	0.8 0.03	68.0 2.68	64.0 2.52	1.4 0.05	1.0 0.04	20.6	10.1	0.0740	0.42 0.94
23.812 0.9375	17.462 0.6875	-5.6 -0.22	0.8 0.03	41.0 1.61	42.0 1.65	0.8 0.03	68.0 2.68	65.0 2.56	0.9 0.03	0.2 0.01	23.1	12.4	0.0718	0.44 0.97
22.225 0.8750	17.462 0.6875	-3.8 -0.15	0.8 0.03	42.0 1.65	42.5 1.67	3.3 0.13	68.0 2.68	62.0 2.44	1.4 0.05	1.0 0.04	20.6	10.1	0.0740	0.41 0.92
24.608 0.9688	19.050 0.7500	-8.1 -0.32	1.5 0.06	40.5 1.59	43.0 1.69	2.3 0.09	68.0 2.68	64.0 2.52	0.9 0.03	1.6 0.07	26.4	10.9	0.0695	0.47 1.03
24.608 0.9688	19.050 0.7500	-8.1 -0.32	1.5 0.06	40.5 1.59	43.0 1.69	0.8 0.03	68.0 2.68	65.0 2.56	0.9 0.03	1.6 0.07	26.4	10.9	0.0695	0.48 1.04
24.608 0.9688	19.050 0.7500	-8.1 -0.32	3.5 0.14	40.5 1.59	47.0 1.85	0.8 0.03	68.0 2.68	65.0 2.56	0.9 0.03	1.6 0.07	26.4	10.9	0.0695	0.47 1.03
24.608 0.9688	19.050 0.7500	-8.1 -0.32	3.5 0.14	40.5 1.59	47.0 1.85	2.3 0.09	68.0 2.68	64.0 2.52	0.9 0.03	1.6 0.07	26.4	10.9	0.0695	0.46 1.02
25.654 1.0100	19.050 0.7500	-8.1 -0.32	0.8 0.03	41.0 1.61	42.0 1.65	0.8 0.03	69.0 2.72	66.0 2.60	1.4 0.05	0.9 0.04	28.7	12.2	0.0725	0.49 1.08
25.654 1.0100	19.050 0.7500	-8.1 -0.32	5.0 0.20	41.0 1.61	51.0 2.01	0.8 0.03	69.0 2.72	66.0 2.60	1.4 0.05	0.9 0.04	28.7	12.2	0.0725	0.48 1.05
24.608 0.9688	19.050 0.7500	-8.1 -0.32	0.8 0.03	42.0 1.65	42.5 1.67	0.8 0.03	68.0 2.68	65.0 2.56	* *	* *	26.4	10.9	0.0695	0.48 1.04
26.975 1.0620	22.225 0.8750	-8.1 -0.32	3.5 0.14	42.1 1.65	49.0 1.93	1.5 0.06	68.0 2.68	63.0 2.48	1.7 0.06	0.8 0.03	24.4	10.7	0.0734	0.52 1.14
25.654 1.0100	19.050 0.7500	-8.1 -0.32	0.8 0.03	41.0 1.61	42.0 1.65	3.3 0.13	70.0 2.76	66.0 2.60	1.4 0.05	0.9 0.04	28.7	12.2	0.0725	0.54 1.18
25.654 1.0100	19.050 0.7500	-8.1 -0.32	5.0 0.20	41.0 1.61	51.0 2.01	0.8 0.03	70.0 2.76	68.0 2.68	1.4 0.05	0.9 0.04	28.7	12.2	0.0725	0.54 1.17
25.654 1.0100	19.050 0.7500	-8.1 -0.32	5.0 0.20	41.0 1.61	51.0 2.01	3.3 0.13	70.0 2.76	66.0 2.60	1.4 0.05	0.9 0.04	28.7	12.2	0.0725	0.53 1.15
25.654 1.0100	19.050 0.7500	-8.1 -0.32	0.8 0.03	41.0 1.61	42.0 1.65	0.8 0.03	70.0 2.76	68.0 2.68	1.4 0.05	0.9 0.04	28.7	12.2	0.0725	0.55 1.20
25.654 1.0100	19.050 0.7500	-8.1 -0.32	3.5 0.14	41.0 1.61	47.5 1.87	0.8 0.03	70.0 2.76	68.0 2.68	1.4 0.05	0.9 0.04	28.7	12.2	0.0725	0.55 1.20

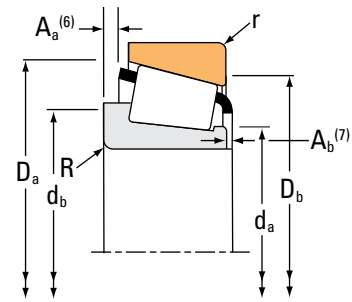
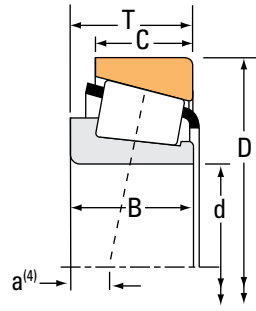
(4) Negative value indicates effective center inside cone (inner-ring) backface.  
 (5) These maximum fillet radii will be cleared by the bearing corners.  
 (6) Negative value indicates cage extends beyond cone (inner-ring) backface.  
 (7) Negative value indicates cage that does not extend beyond cone (inner-ring) front face.  
 (\*) Contact your Timken engineer for details.

Continued on next page.

# TAPERED ROLLER BEARINGS

## SINGLE-ROW • TYPE TS

### TYPE TS



Bearing Dimensions			Load Ratings							Part Number			
Bore d	O.D. D	Width T	Dynamic <sup>(1)</sup>		Factors <sup>(2)</sup>		Dynamic <sup>(3)</sup>		Factors <sup>(2)</sup>		Static C <sub>0</sub>	Inner	Outer
			C <sub>1</sub>	e	Y	C <sub>90</sub>	C <sub>a90</sub>	K	N	N			
mm in.	mm in.	mm in.	N lbf			N lbf	N lbf		N lbf				
34.925 1.3750	76.200 3.0000	29.370 1.1563	99900 22500	0.35	1.71	25900 5820	15500 3490	1.67	111000 24900		36137	36300	
34.925 1.3750	76.200 3.0000	29.370 1.1563	94700 21300	0.40	1.49	24600 5520	16900 3800	1.45	107000 24100		31593	31520	
34.925 1.3750	76.200 3.0000	29.370 1.1563	94700 21300	0.40	1.49	24600 5520	16900 3800	1.45	107000 24100		31593	31521	
34.925 1.3750	76.200 3.0000	29.370 1.1563	94700 21300	0.40	1.49	24600 5520	16900 3800	1.45	107000 24100		31594	31520	
34.925 1.3750	76.200 3.0000	29.370 1.1563	110000 24800	0.55	1.10	28600 6440	26800 6020	1.07	119000 26700		HM89446	HM89410	
34.925 1.3750	76.200 3.0000	29.370 1.1563	110000 24800	0.55	1.10	28600 6440	26800 6020	1.07	119000 26700		HM89446A	HM89410	
34.925 1.3750	79.325 3.1230	29.370 1.1563	105000 23500	0.37	1.64	27100 6100	17000 3820	1.60	119000 26800		3482	3426	
34.925 1.3750	79.375 3.1250	29.370 1.1563	105000 23500	0.37	1.64	27100 6100	17000 3820	1.60	119000 26800		3478	3420	
34.925 1.3750	79.375 3.1250	29.370 1.1563	105000 23500	0.37	1.64	27100 6100	17000 3820	1.60	119000 26800		3482	3420	
34.925 1.3750	80.000 3.1496	21.000 0.8268	94300 21200	0.27	2.20	24400 5490	11400 2570	2.14	83400 18700		335	332	
34.925 1.3750	80.000 3.1496	24.175 0.9518	94300 21200	0.27	2.20	24400 5490	11400 2570	2.14	83400 18700		335	332A	
34.925 1.3750	80.035 3.1510	21.433 0.8438	75200 16900	0.40	1.49	19500 4390	13400 3020	1.45	68900 15500		28137	28317	
34.925 1.3750	80.035 3.1510	24.608 0.9688	78000 17500	0.56	1.07	20200 4550	19400 4370	1.04	91100 20500		27875	27820	
34.925 1.3750	80.035 3.1510	29.370 1.1563	115000 25800	0.27	2.20	29800 6700	13900 3130	2.14	129000 29100		3379	3339	
34.925 1.3750	80.167 3.1562	26.988 1.0625	94300 21200	0.27	2.20	24400 5490	11400 2570	2.14	83400 18700		335	3320	
34.925 1.3750	80.167 3.1562	29.367 1.1562	115000 25800	0.27	2.20	29800 6700	13900 3130	2.14	129000 29100		3379	3320	
34.925 1.3750	80.962 3.1875	22.225 0.8750	65700 14800	0.45	1.32	17000 3830	13200 2980	1.29	74900 16800		02877	02831	

<sup>(1)</sup>Based on 1 x 10<sup>6</sup> revolutions L<sub>10</sub> life, for the ISO life-calculation method.

<sup>(2)</sup>Consult your Timken engineer for instructions on use or review the Timken Engineering Manual on timken.com/catalogs.

<sup>(3)</sup>Based on 90 x 10<sup>6</sup> revolutions L<sub>10</sub> life, for The Timken Company life-calculation method. C<sub>90</sub> and C<sub>a90</sub> are radial and thrust values.

Bearing Dimensions											Geometry Factors			Bearing Weight
Width B	Width C	Eff. Ctr. a <sup>(4)</sup>	Shaft			Housing			Cage		G <sub>1</sub>	G <sub>2</sub>	C <sub>g</sub>	
			Max Shaft Fillet Radius R <sup>(5)</sup>	Backing Shoulder Dia. d <sub>a</sub>	Shoulder Dia. d <sub>b</sub>	Max Housing Fillet Radius r <sup>(5)</sup>	Backing Shoulder Dia. D <sub>a</sub>	Shoulder Dia. D <sub>b</sub>	A <sub>a</sub> <sup>(6)</sup>	A <sub>b</sub> <sup>(7)</sup>				
mm in.	mm in.	mm in.	mm in.	mm in.	mm in.	mm in.	mm in.	mm in.	mm in.	mm in.				kg lbs.
29.845 1.1750	23.812 0.9375	-9.1 -0.36	1.5 0.06	42.5 1.67	45.0 1.77	3.3 0.13	71.0 2.80	66.0 2.60	* *	* *	26.7	10.5	0.0741	0.62 1.37
28.575 1.1250	23.812 0.9375	-7.6 -0.30	3.5 0.14	43.5 1.71	50.0 1.97	3.3 0.13	72.0 2.83	64.0 2.52	1.6 0.06	1.3 0.05	26.3	9.1	0.0773	0.61 1.35
28.575 1.1250	23.812 0.9375	-7.6 -0.30	3.5 0.14	43.5 1.71	50.0 1.97	1.3 0.05	72.0 2.83	66.0 2.60	1.6 0.06	1.3 0.05	26.3	9.1	0.0773	0.62 1.37
28.575 1.1250	23.812 0.9375	-7.6 -0.30	1.5 0.06	43.5 1.71	46.0 1.81	3.3 0.13	72.0 2.83	64.0 2.52	1.6 0.06	1.3 0.05	26.3	9.1	0.0773	0.62 1.36
28.575 1.1250	23.020 0.9063	-5.6 -0.22	3.5 0.14	44.5 1.75	56.0 2.20	3.3 0.13	73.0 2.87	62.0 2.44	1.9 0.07	1.4 0.06	28.9	9.9	0.0883	0.64 1.42
28.575 1.1250	23.020 0.9063	-5.6 -0.22	0.8 0.03	44.5 1.75	47.5 1.87	3.3 0.13	73.0 2.87	62.0 2.44	1.9 0.07	1.4 0.06	28.9	9.9	0.0883	0.64 1.42
29.771 1.1721	23.812 0.9375	-8.6 -0.34	0.8 0.03	43.5 1.71	44.0 1.73	3.3 0.13	74.0 2.91	67.0 2.64	1.4 0.05	1.0 0.04	29.9	11.2	0.0781	0.70 1.55
29.771 1.1721	23.812 0.9375	-8.6 -0.34	3.5 0.14	43.5 1.71	50.0 1.97	3.3 0.13	74.0 2.91	67.0 2.64	1.4 0.05	1.0 0.04	29.9	11.2	0.0781	0.69 1.54
29.771 1.1721	23.812 0.9375	-8.6 -0.34	0.8 0.03	43.5 1.71	44.0 1.73	3.3 0.13	74.0 2.91	67.0 2.64	1.4 0.05	1.0 0.04	29.9	11.2	0.0781	0.70 1.55
22.403 0.8820	17.826 0.7018	-6.4 -0.25	0.8 0.03	41.5 1.63	42.5 1.67	1.3 0.05	75.0 2.95	73.0 2.87	0.7 0.02	1.1 0.05	26.5	13.0	0.0676	0.52 1.17
22.403 0.8820	21.000 0.8268	-6.4 -0.25	0.8 0.03	41.5 1.63	42.5 1.67	2.3 0.09	75.0 2.95	71.0 2.80	0.7 0.02	1.1 0.05	26.5	13.0	0.0676	0.56 1.25
20.940 0.8244	15.875 0.6250	-4.8 -0.19	1.5 0.06	41.0 1.61	43.5 1.71	1.5 0.06	73.0 2.87	69.0 2.72	2.3 0.09	1.1 0.05	20.7	12.5	0.0709	0.49 1.09
23.698 0.9330	18.512 0.7288	-2.5 -0.10	0.8 0.03	44.5 1.75	45.5 1.79	1.5 0.06	75.0 2.95	68.0 2.68	3.2 0.12	1.5 0.06	24.6	12.6	0.0839	0.59 1.31
30.391 1.1965	23.812 0.9375	-10.9 -0.43	3.5 0.14	41.5 1.63	48.0 1.89	1.5 0.06	74.8 2.94	71.0 2.80	1.8 0.07	1.1 0.05	34.6	12.1	0.0744	0.71 1.59
22.403 0.8820	23.812 0.9375	-6.4 -0.25	0.8 0.03	41.5 1.63	42.5 1.67	3.3 0.13	75.0 2.95	70.0 2.76	0.7 0.02	1.1 0.05	26.5	13.0	0.0676	0.59 1.31
30.391 1.1965	23.812 0.9375	-10.9 -0.43	3.5 0.14	41.5 1.63	48.0 1.89	3.3 0.13	75.0 2.95	70.0 2.76	1.8 0.07	1.1 0.05	34.6	12.1	0.0744	0.71 1.58
22.225 0.8750	17.462 0.6875	-3.8 -0.15	3.5 0.14	42.0 1.65	48.5 1.91	0.8 0.03	72.0 2.83	67.0 2.64	1.4 0.05	1.0 0.04	20.6	10.1	0.0740	0.55 1.22

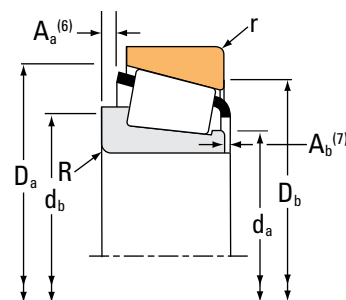
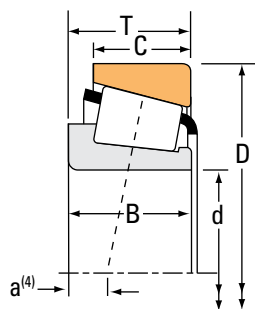
(4) Negative value indicates effective center inside cone (inner-ring) backface.  
 (5) These maximum fillet radii will be cleared by the bearing corners.  
 (6) Negative value indicates cage extends beyond cone (inner-ring) backface.  
 (7) Negative value indicates cage that does not extend beyond cone (inner-ring) front face.  
 (\*) Contact your Timken engineer for details.

Continued on next page.

# TAPERED ROLLER BEARINGS

## SINGLE-ROW • TYPE TS

### TYPE TS



Bearing Dimensions			Load Ratings							Part Number		
Bore d	O.D. D	Width T	Dynamic <sup>(1)</sup>		Factors <sup>(2)</sup>		Dynamic <sup>(3)</sup>		Factors <sup>(2)</sup>	Static	Inner	Outer
			C <sub>1</sub>	e	Y	C <sub>90</sub>	C <sub>a90</sub>	K	C <sub>0</sub>			
mm in.	mm in.	mm in.	N lbf			N lbf	N lbf			N lbf		
34.925 1.3750	81.755 3.2187	29.370 1.1563	115000 25800	0.27	2.20	29800 6700	13900 3130	2.14	129000 29100	3379	3329	
34.925 1.3750	84.138 3.3125	29.370 1.1563	115000 25800	0.27	2.20	29800 6700	13900 3130	2.14	129000 29100	3379	3328	
34.925 1.3750	85.725 3.3750	30.162 1.1875	124000 27900	0.40	1.49	32200 7240	22200 4980	1.45	148000 33200	3872	3821	
34.925 1.3750	85.725 3.3750	30.162 1.1875	124000 27900	0.40	1.49	32200 7240	22200 4980	1.45	148000 33200	3872A	3820	
34.925 1.3750	85.725 3.3750	30.162 1.1875	124000 27900	0.40	1.49	32200 7240	22200 4980	1.45	148000 33200	3872	3820	
34.925 1.3750	87.312 3.4375	30.162 1.1875	113000 25500	0.31	1.96	29400 6610	15400 3460	1.91	134000 30100	3581	3525	
34.925 1.3750	88.500 3.4843	26.988 1.0625	116000 26000	0.26	2.28	30000 6740	13500 3040	2.22	124000 28000	417	414	
34.925 1.3750	90.488 3.5625	39.688 1.5625	199000 44700	0.28	2.11	51500 11600	25100 5640	2.05	204000 45900	4368	4335	
34.925 1.3750	95.250 3.7500	27.783 1.0938	127000 28500	0.28	2.11	32900 7400	16000 3600	2.05	144000 32400	449	432	
34.976 1.3770	68.000 2.6772	16.019 0.6307	50700 11400	0.44	1.35	13100 2960	10000 2250	1.31	57800 13000	19138	19267X	
34.976 1.3770	68.262 2.6875	15.875 0.6250	50700 11400	0.44	1.35	13100 2960	10000 2250	1.31	57800 13000	19138	19268	
34.976 1.3770	69.012 2.7170	19.845 0.7813	54600 12300	0.38	1.57	14200 3180	9260 2080	1.53	61700 13900	14139	14274	
34.976 1.3770	69.012 2.7170	19.845 0.7813	54600 12300	0.38	1.57	14200 3180	9260 2080	1.53	61700 13900	14139	14276	
34.976 1.3770	71.996 2.8345	19.002 0.7481	54600 12300	0.38	1.57	14200 3180	9260 2080	1.53	61700 13900	14139	14282	
34.976 1.3770	72.000 2.8346	17.018 0.6700	50700 11400	0.44	1.35	13100 2960	10000 2250	1.31	57800 13000	19138	19283	
34.976 1.3770	72.085 2.8380	22.385 0.8813	54600 12300	0.38	1.57	14200 3180	9260 2080	1.53	61700 13900	14139	14283	
34.976 1.3770	76.200 3.0000	20.625 0.8120	63500 14300	0.40	1.49	16500 3700	11300 2550	1.45	68900 15500	28138	28300X	

<sup>(1)</sup>Based on 1 x 10<sup>6</sup> revolutions L<sub>10</sub> life, for the ISO life-calculation method.

<sup>(2)</sup>Consult your Timken engineer for instructions on use or review the Timken Engineering Manual on timken.com/catalogs.

<sup>(3)</sup>Based on 90 x 10<sup>6</sup> revolutions L<sub>10</sub> life, for The Timken Company life-calculation method. C<sub>90</sub> and C<sub>a90</sub> are radial and thrust values.

Bearing Dimensions											Geometry Factors			Bearing Weight
Width B	Width C	Eff. Ctr. a <sup>(4)</sup>	Shaft			Housing			Cage		G <sub>1</sub>	G <sub>2</sub>	C <sub>g</sub>	
			Max Shaft Fillet Radius R <sup>(5)</sup>	Backing Shoulder Dia. d <sub>a</sub>	Backing Shoulder Dia. d <sub>b</sub>	Max Housing Fillet Radius r <sup>(5)</sup>	Backing Shoulder Dia. D <sub>a</sub>	Backing Shoulder Dia. D <sub>b</sub>	A <sub>a</sub> <sup>(6)</sup>	A <sub>b</sub> <sup>(7)</sup>				
mm in.	mm in.	mm in.	mm in.	mm in.	mm in.	mm in.	mm in.	mm in.	mm in.	mm in.				kg lbs.
<b>30.391</b> 1.1965	<b>23.812</b> 0.9375	<b>-10.9</b> -0.43	<b>3.5</b> 0.14	<b>41.5</b> 1.63	<b>48.0</b> 1.89	<b>3.3</b> 0.13	<b>75.0</b> 2.95	<b>71.0</b> 2.80	<b>1.8</b> 0.07	<b>1.1</b> 0.05	34.6	12.1	0.0744	<b>0.75</b> 1.66
<b>30.391</b> 1.1965	<b>23.812</b> 0.9375	<b>-10.9</b> -0.43	<b>3.5</b> 0.14	<b>41.5</b> 1.63	<b>48.0</b> 1.89	<b>3.3</b> 0.13	<b>76.0</b> 2.99	<b>72.0</b> 2.83	<b>1.8</b> 0.07	<b>1.1</b> 0.05	34.6	12.1	0.0744	<b>0.80</b> 1.79
<b>30.162</b> 1.1875	<b>23.812</b> 0.9375	<b>-8.1</b> -0.32	<b>3.5</b> 0.14	<b>46.0</b> 1.81	<b>53.0</b> 2.09	<b>1.3</b> 0.05	<b>81.0</b> 3.19	<b>75.0</b> 2.95	<b>1.4</b> 0.05	<b>2.2</b> 0.09	37.8	13.5	0.0873	<b>0.90</b> 1.98
<b>30.162</b> 1.1875	<b>23.812</b> 0.9375	<b>-8.1</b> -0.32	<b>0.8</b> 0.03	<b>46.0</b> 1.81	<b>47.0</b> 1.85	<b>3.3</b> 0.13	<b>81.0</b> 3.19	<b>73.0</b> 2.87	<b>1.4</b> 0.05	<b>2.2</b> 0.09	37.8	13.5	0.0873	<b>0.89</b> 1.96
<b>30.162</b> 1.1875	<b>23.812</b> 0.9375	<b>-8.1</b> -0.32	<b>3.5</b> 0.14	<b>46.0</b> 1.81	<b>53.0</b> 2.09	<b>3.3</b> 0.13	<b>81.0</b> 3.19	<b>73.0</b> 2.87	<b>1.4</b> 0.05	<b>2.2</b> 0.09	37.8	13.5	0.0873	<b>0.89</b> 1.96
<b>30.886</b> 1.2160	<b>23.812</b> 0.9375	<b>-10.2</b> -0.40	<b>3.5</b> 0.14	<b>43.0</b> 1.69	<b>49.5</b> 1.95	<b>3.3</b> 0.13	<b>81.0</b> 3.19	<b>75.0</b> 2.95	<b>2.2</b> 0.09	<b>0.7</b> 0.03	39.5	12.5	0.0808	<b>0.92</b> 2.00
<b>29.083</b> 1.1450	<b>22.225</b> 0.8750	<b>-9.7</b> -0.38	<b>0.8</b> 0.03	<b>42.0</b> 1.65	<b>42.5</b> 1.67	<b>1.5</b> 0.06	<b>80.0</b> 3.15	<b>77.0</b> 3.03	<b>1.2</b> 0.04	<b>0.8</b> 0.03	34.4	9.9	0.0731	<b>0.88</b> 1.92
<b>40.386</b> 1.5900	<b>33.338</b> 1.3125	<b>-15.0</b> -0.59	<b>3.5</b> 0.14	<b>49.0</b> 1.93	<b>55.0</b> 2.17	<b>3.3</b> 0.13	<b>85.0</b> 3.35	<b>77.0</b> 3.03	<b>2.2</b> 0.09	<b>0.6</b> 0.03	52.9	14.3	0.0872	<b>1.36</b> 3.01
<b>29.900</b> 1.1772	<b>22.225</b> 0.8750	<b>-9.1</b> -0.36	<b>0.8</b> 0.03	<b>43.5</b> 1.71	<b>44.0</b> 1.73	<b>2.3</b> 0.09	<b>87.0</b> 3.43	<b>83.0</b> 3.27	<b>1.6</b> 0.06	<b>0.5</b> 0.02	42.5	11.3	0.0805	<b>1.08</b> 2.38
<b>16.520</b> 0.6504	<b>12.000</b> 0.4724	<b>-1.5</b> -0.06	<b>1.5</b> 0.06	<b>40.5</b> 1.59	<b>42.5</b> 1.67	<b>1.5</b> 0.06	<b>64.0</b> 2.52	<b>61.0</b> 2.40	<b>1.1</b> 0.04	<b>1.6</b> 0.06	17.5	11.5	0.0694	<b>0.26</b> 0.57
<b>16.520</b> 0.6504	<b>11.908</b> 0.4688	<b>-1.5</b> -0.06	<b>1.5</b> 0.06	<b>40.5</b> 1.59	<b>42.5</b> 1.67	<b>1.5</b> 0.06	<b>65.0</b> 2.56	<b>61.0</b> 2.40	<b>1.1</b> 0.04	<b>1.6</b> 0.06	17.5	11.5	0.0694	<b>0.26</b> 0.58
<b>19.583</b> 0.7710	<b>15.875</b> 0.6250	<b>-4.3</b> -0.17	<b>1.3</b> 0.05	<b>41.5</b> 1.63	<b>43.5</b> 1.71	<b>3.3</b> 0.13	<b>63.0</b> 2.48	<b>59.0</b> 2.32	<b>1.0</b> 0.04	<b>1.5</b> 0.06	18.0	13.3	0.0668	<b>0.32</b> 0.70
<b>19.583</b> 0.7710	<b>15.875</b> 0.6250	<b>-4.3</b> -0.17	<b>1.3</b> 0.05	<b>41.5</b> 1.63	<b>43.5</b> 1.71	<b>1.3</b> 0.05	<b>63.0</b> 2.48	<b>60.0</b> 2.36	<b>1.0</b> 0.04	<b>1.5</b> 0.06	18.0	13.3	0.0668	<b>0.32</b> 0.72
<b>19.583</b> 0.7710	<b>15.032</b> 0.5918	<b>-4.3</b> -0.17	<b>1.3</b> 0.05	<b>41.5</b> 1.63	<b>43.5</b> 1.71	<b>1.5</b> 0.06	<b>65.0</b> 2.56	<b>62.0</b> 2.44	<b>1.0</b> 0.04	<b>1.5</b> 0.06	18.0	13.3	0.0668	<b>0.35</b> 0.78
<b>16.520</b> 0.6504	<b>14.288</b> 0.5625	<b>-1.5</b> -0.06	<b>1.5</b> 0.06	<b>40.5</b> 1.59	<b>42.5</b> 1.67	<b>1.5</b> 0.06	<b>66.0</b> 2.60	<b>63.0</b> 2.48	<b>1.1</b> 0.04	<b>1.6</b> 0.06	17.5	11.5	0.0694	<b>0.32</b> 0.70
<b>19.583</b> 0.7710	<b>18.415</b> 0.7250	<b>-4.3</b> -0.17	<b>1.3</b> 0.05	<b>41.5</b> 1.63	<b>43.5</b> 1.71	<b>2.3</b> 0.09	<b>65.0</b> 2.56	<b>60.0</b> 2.36	<b>1.0</b> 0.04	<b>1.5</b> 0.06	18.0	13.3	0.0668	<b>0.40</b> 0.88
<b>20.940</b> 0.8244	<b>15.494</b> 0.6100	<b>-4.8</b> -0.19	<b>1.5</b> 0.06	<b>41.0</b> 1.61	<b>43.5</b> 1.71	<b>1.5</b> 0.06	<b>71.0</b> 2.80	<b>68.0</b> 2.68	<b>2.3</b> 0.09	<b>1.1</b> 0.05	20.7	12.5	0.0709	<b>0.43</b> 0.95

<sup>(4)</sup>Negative value indicates effective center inside cone (inner-ring) backface.

<sup>(5)</sup>These maximum fillet radii will be cleared by the bearing corners.

<sup>(6)</sup>Negative value indicates cage extends beyond cone (inner-ring) backface.

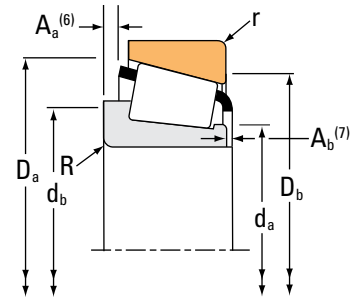
<sup>(7)</sup>Negative value indicates cage that does not extend beyond cone (inner-ring) front face.

Continued on next page.

# TAPERED ROLLER BEARINGS

## SINGLE-ROW • TYPE TS

### TYPE TS



Bearing Dimensions			Load Ratings							Part Number			
Bore d	O.D. D	Width T	Dynamic <sup>(1)</sup>		Factors <sup>(2)</sup>		Dynamic <sup>(3)</sup>		Factors <sup>(2)</sup>		Static C <sub>0</sub>	Inner	Outer
			C <sub>1</sub>	e	Y	C <sub>90</sub>	C <sub>a90</sub>	K	N	N			
mm in.	mm in.	mm in.	N lbf			N lbf	N lbf		N lbf				
34.976 1.3770	80.000 3.1496	21.005 0.8270	63500 14300	0.40	1.49	16500 3700	11300 2550	1.45	68900 15500		28138	28315	
34.987 1.3775	59.131 2.3280	15.875 0.6250	45500 10200	0.42	1.44	11800 2650	8400 1890	1.40	48700 11000		L68149	L68110	
34.987 1.3775	59.975 2.3612	15.875 0.6250	45500 10200	0.42	1.44	11800 2650	8400 1890	1.40	48700 11000		L68149	L68111	
34.987 1.3775	61.973 2.4399	16.700 0.6575	42500 9560	0.44	1.35	11000 2480	8380 1880	1.31	52400 11800		LM78349	LM78310A	
34.987 1.3775	61.973 2.4399	16.701 0.6575	50400 11300	0.44	1.35	13100 2940	9940 2230	1.31	52400 11800		LM78349A	LM78310A	
34.987 1.3775	61.973 2.4399	18.001 0.7087	42500 9560	0.44	1.35	11000 2480	8380 1880	1.31	52400 11800		LM78349	LM78310C	
34.987 1.3775	61.973 2.4399	18.001 0.7087	50400 11300	0.44	1.35	13100 2940	9940 2230	1.31	52400 11800		LM78349A	LM78310C	
34.987 1.3775	65.987 2.5979	20.638 0.8125	62400 14000	0.35	1.70	16200 3640	9770 2200	1.66	72800 16400		M38547	M38511	
35.000 1.3780	70.000 2.7559	24.000 0.9949	66600 15000	0.55	1.10	17300 3880	16100 3630	1.07	84900 19100		JS-3549A	JS-3510	
35.000 1.3780	72.000 2.8346	17.018 0.6700	50700 11400	0.44	1.35	13100 2960	10000 2250	1.31	57800 13000		19138X	19283	
35.000 1.3780	72.000 2.8346	17.018 0.6700	50700 11400	0.44	1.35	13100 2960	10000 2250	1.31	57800 13000		19138X	19283X	
35.000 1.3780	73.025 2.8750	26.988 1.0625	89400 20100	0.37	1.62	23200 5210	14700 3300	1.58	102000 22900		23691	23620	
35.000 1.3780	73.025 2.8750	26.988 1.0625	89400 20100	0.37	1.62	23200 5210	14700 3300	1.58	102000 22900		23691	23621	
35.000 1.3780	75.311 2.9650	19.845 0.7813	54600 12300	0.38	1.57	14200 3180	9260 2080	1.53	61700 13900		14139X	14274-S	
35.000 1.3780	79.375 3.1250	23.812 0.9375	91100 20500	0.32	1.88	23600 5310	12900 2900	1.83	110000 24800		26883	26822	
35.000 1.3780	80.000 3.1496	21.000 0.8268	94300 21200	0.27	2.20	24400 5490	11400 2570	2.14	83400 18700		339	332	
35.000 1.3780	80.000 3.1496	23.813 0.9375	91100 20500	0.32	1.88	23600 5310	12900 2900	1.83	110000 24800		26883	26824	

<sup>(1)</sup>Based on 1 x 10<sup>6</sup> revolutions L<sub>10</sub> life, for the ISO life-calculation method.

<sup>(2)</sup>Consult your Timken engineer for instructions on use or review the Timken Engineering Manual on timken.com/catalogs.

<sup>(3)</sup>Based on 90 x 10<sup>6</sup> revolutions L<sub>10</sub> life, for The Timken Company life-calculation method. C<sub>90</sub> and C<sub>a90</sub> are radial and thrust values.



Bearing Dimensions											Geometry Factors			Bearing Weight
Width B	Width C	Eff. Ctr. a <sup>(4)</sup>	Shaft			Housing			Cage		G <sub>1</sub>	G <sub>2</sub>	C <sub>g</sub>	
			Max Shaft Fillet Radius R <sup>(5)</sup>	Backing Shoulder Dia. d <sub>a</sub>	Backing Shoulder Dia. d <sub>b</sub>	Max Housing Fillet Radius r <sup>(5)</sup>	Backing Shoulder Dia. D <sub>a</sub>	Backing Shoulder Dia. D <sub>b</sub>	A <sub>a</sub> <sup>(6)</sup>	A <sub>b</sub> <sup>(7)</sup>				
mm in.	mm in.	mm in.	mm in.	mm in.	mm in.	mm in.	mm in.	mm in.	mm in.	mm in.				kg lbs.
20.940 0.8244	15.875 0.6250	-4.8 -0.19	1.5 0.06	41.0 1.61	43.5 1.71	1.5 0.06	73.0 2.87	69.0 2.72	2.3 0.09	1.1 0.05	20.7	12.5	0.0709	0.49 1.08
16.764 0.6600	11.938 0.4700	-2.5 -0.10	3.5 0.14	39.0 1.54	45.5 1.79	1.3 0.05	56.0 2.20	53.0 2.09	0.8 0.03	0.8 0.03	15.7	14.7	0.0657	0.17 0.37
16.764 0.6600	11.938 0.4700	-2.5 -0.10	3.5 0.14	39.0 1.54	45.5 1.79	1.3 0.05	56.0 2.20	53.0 2.09	0.8 0.03	0.8 0.03	15.7	14.7	0.0657	0.17 0.38
17.000 0.6693	13.600 0.5354	-2.5 -0.10	3.5 0.14	40.0 1.57	46.0 1.81	1.5 0.06	59.0 2.32	54.0 2.13	0.7 0.02	1.2 0.05	16.1	15.9	0.0678	0.19 0.44
17.000 0.6693	13.600 0.5354	-2.5 -0.10	1.5 0.06	39.5 1.56	42.0 1.65	1.5 0.06	59.0 2.32	54.0 2.13	0.7 0.02	1.2 0.05	16.1	15.9	0.0678	0.20 0.47
17.000 0.6693	15.000 0.5906	-2.5 -0.10	3.5 0.14	40.0 1.57	46.0 1.81	1.5 0.06	59.0 2.32	56.0 2.20	0.7 0.02	1.2 0.05	16.1	15.9	0.0678	0.20 0.46
17.000 0.6693	15.000 0.5906	-2.5 -0.10	1.5 0.06	39.5 1.56	42.0 1.65	1.5 0.06	59.0 2.32	56.0 2.20	0.7 0.02	1.2 0.05	16.1	15.9	0.0678	0.21 0.49
20.638 0.8125	16.670 0.6563	-5.6 -0.22	3.5 0.14	40.5 1.59	46.5 1.83	2.3 0.09	62.0 2.44	58.0 2.28	0.4 0.01	2.4 0.10	20.3	12.9	0.0680	0.30 0.66
23.500 0.9252	19.000 0.7480	-3.6 -0.14	2.0 0.08	42.0 1.65	47.0 1.85	1.5 0.06	66.5 2.62	60.0 2.36	1.5 0.06	1.6 0.07	20.7	11.0	0.0789	0.41 0.91
16.520 0.6504	14.288 0.5625	-1.5 -0.06	2.0 0.08	40.5 1.59	43.5 1.71	1.5 0.06	66.0 2.60	63.0 2.48	1.1 0.04	1.6 0.06	17.5	11.5	0.0694	0.32 0.70
16.520 0.6504	14.288 0.5625	-1.5 -0.06	2.0 0.08	40.5 1.59	43.5 1.71	2.0 0.08	66.0 2.60	62.0 2.44	1.1 0.04	1.6 0.06	17.5	11.5	0.0694	0.32 0.70
26.975 1.0620	22.225 0.8750	-8.1 -0.32	3.5 0.14	42.1 1.65	49.0 1.93	1.5 0.06	68.0 2.68	63.0 2.48	1.7 0.06	0.8 0.03	24.4	10.7	0.0734	0.52 1.14
26.975 1.0620	22.225 0.8750	-8.1 -0.32	3.5 0.14	42.1 1.65	49.0 1.93	0.8 0.03	68.0 2.68	63.0 2.48	1.7 0.06	0.8 0.03	24.4	10.7	0.0734	0.52 1.14
19.583 0.7710	15.875 0.6250	-4.3 -0.17	3.5 0.14	41.0 1.61	47.0 1.85	3.3 0.13	66.0 2.60	61.0 2.40	1.0 0.04	1.5 0.06	18.0	13.3	0.0668	0.40 0.89
25.400 1.0000	19.050 0.7500	-7.4 -0.29	0.8 0.03	42.0 1.65	42.5 1.67	0.8 0.03	74.0 2.91	71.0 2.80	1.4 0.05	1.3 0.05	32.8	13.3	0.0770	0.60 1.33
22.403 0.8820	17.826 0.7018	-6.4 -0.25	0.8 0.03	41.5 1.63	42.5 1.67	1.3 0.05	75.0 2.95	73.0 2.87	0.7 0.02	1.1 0.05	26.5	13.0	0.0676	0.52 1.17
25.400 1.0000	19.050 0.7500	-7.4 -0.29	0.8 0.03	42.0 1.65	42.5 1.67	1.3 0.05	74.0 2.91	70.0 2.76	1.4 0.05	1.3 0.05	32.8	13.3	0.0770	0.62 1.36

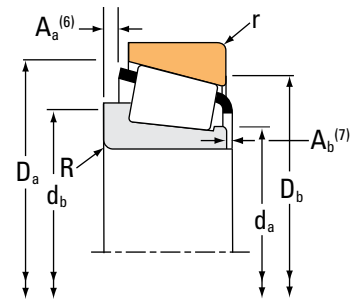
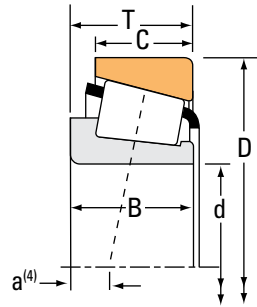
(4) Negative value indicates effective center inside cone (inner-ring) backface.  
 (5) These maximum fillet radii will be cleared by the bearing corners.  
 (6) Negative value indicates cage extends beyond cone (inner-ring) backface.  
 (7) Negative value indicates cage that does not extend beyond cone (inner-ring) front face.

Continued on next page.

# TAPERED ROLLER BEARINGS

## SINGLE-ROW • TYPE TS

### TYPE TS



Bearing Dimensions			Load Ratings							Part Number		
Bore d	O.D. D	Width T	Dynamic <sup>(1)</sup>		Factors <sup>(2)</sup>		Dynamic <sup>(3)</sup>		Factors <sup>(2)</sup>	Static	Inner	Outer
			C <sub>1</sub>	e	Y	C <sub>90</sub>	C <sub>a90</sub>	K	C <sub>0</sub>			
mm in.	mm in.	mm in.	N lbf			N lbf	N lbf			N lbf		
35.000 1.3780	80.167 3.1562	25.400 1.0000	91100 20500	0.32	1.88	23600 5310	12900 2900	1.83	110000 24800	26883	26820	
35.000 1.3780	80.167 3.1562	29.370 1.1563	105000 23500	0.37	1.64	27100 6100	17000 3820	1.60	119000 26800	3480	3422	
35.000 1.3780	82.550 3.2500	28.575 1.1250	116000 26000	0.26	2.28	30000 6740	13500 3040	2.22	124000 28000	421	412A	
35.000 1.3780	88.500 3.4843	26.988 1.0625	116000 26000	0.26	2.28	30000 6740	13500 3040	2.22	124000 28000	421	414	
35.306 1.3900	73.025 2.8750	22.225 0.8750	73200 16400	0.37	1.63	19000 4260	12000 2690	1.59	83800 18800	2880	2820	
35.717 1.4062	72.233 2.8438	25.400 1.0000	76800 17300	0.55	1.10	19900 4480	18600 4180	1.07	94200 21200	HM88648	HM88610	
36.487 1.4365	73.025 2.8750	23.812 0.9375	86900 19500	0.30	1.98	22500 5060	11700 2630	1.93	102000 23000	2794	2735X	
36.487 1.4365	73.025 2.8750	23.812 0.9375	85100 19100	0.29	2.07	22100 4960	11000 2460	2.01	97400 21900	25880	25821	
36.487 1.4365	73.025 2.8750	23.812 0.9375	86900 19500	0.30	1.98	22500 5060	11700 2630	1.93	102000 23000	2780	2735X	
36.487 1.4365	73.025 2.8750	23.812 0.9375	85100 19100	0.29	2.07	22100 4960	11000 2460	2.01	97400 21900	25880	25820	
36.487 1.4365	74.612 2.9375	23.812 0.9375	86900 19500	0.30	1.98	22500 5060	11700 2630	1.93	102000 23000	2780	2736	
36.487 1.4365	76.200 3.0000	23.812 0.9375	86900 19500	0.30	1.98	22500 5060	11700 2630	1.93	102000 23000	2794	2720	
36.487 1.4365	76.200 3.0000	23.812 0.9375	86900 19500	0.30	1.98	22500 5060	11700 2630	1.93	102000 23000	2780	2720	
36.487 1.4365	76.200 3.0000	23.812 0.9375	86900 19500	0.30	1.98	22500 5060	11700 2630	1.93	102000 23000	2780	2729	
36.487 1.4365	79.375 3.1250	23.812 0.9375	86900 19500	0.30	1.98	22500 5060	11700 2630	1.93	102000 23000	2780	2731	
36.512 1.4375	68.262 2.6875	15.875 0.6250	50700 11400	0.44	1.35	13100 2960	10000 2250	1.31	57800 13000	19143	19268	
36.512 1.4375	69.012 2.7170	19.050 0.7500	67200 15100	0.40	1.49	17400 3920	12000 2700	1.45	67900 15300	13682	13621	

<sup>(1)</sup>Based on 1 x 10<sup>6</sup> revolutions L<sub>10</sub> life, for the ISO life-calculation method.

<sup>(2)</sup>Consult your Timken engineer for instructions on use or review the Timken Engineering Manual on timken.com/catalogs.

<sup>(3)</sup>Based on 90 x 10<sup>6</sup> revolutions L<sub>10</sub> life, for The Timken Company life-calculation method. C<sub>90</sub> and C<sub>a90</sub> are radial and thrust values.

Bearing Dimensions											Geometry Factors			Bearing Weight
Width B	Width C	Eff. Ctr. a <sup>(4)</sup>	Shaft			Housing			Cage		G <sub>1</sub>	G <sub>2</sub>	C <sub>g</sub>	
			Max Shaft Fillet Radius R <sup>(5)</sup>	Backing Shoulder Dia. d <sub>a</sub>	Backing Shoulder Dia. d <sub>b</sub>	Max Housing Fillet Radius r <sup>(5)</sup>	Backing Shoulder Dia. D <sub>a</sub>	Backing Shoulder Dia. D <sub>b</sub>	A <sub>a</sub> <sup>(6)</sup>	A <sub>b</sub> <sup>(7)</sup>				
mm in.	mm in.	mm in.	mm in.	mm in.	mm in.	mm in.	mm in.	mm in.	mm in.	mm in.				kg lbs.
25.400 1.0000	20.638 0.8125	-7.4 -0.29	0.8 0.03	42.0 1.65	42.5 1.67	3.3 0.13	74.0 2.91	69.0 2.72	1.4 0.05	1.3 0.05	32.8	13.3	0.0770	0.63 1.39
29.771 1.1721	23.812 0.9375	-8.6 -0.34	1.5 0.06	43.5 1.71	46.0 1.81	3.3 0.13	74.0 2.91	68.0 2.68	1.4 0.05	1.0 0.04	29.9	11.2	0.0781	0.72 1.59
29.083 1.1450	23.812 0.9375	-9.7 -0.38	0.8 0.03	42.0 1.65	42.5 1.67	1.5 0.06	77.7 3.06	73.9 2.91	1.2 0.04	0.8 0.03	34.4	9.9	0.0731	0.76 1.65
29.083 1.1450	22.225 0.8750	-9.7 -0.38	0.8 0.03	42.0 1.65	42.5 1.67	1.5 0.06	80.0 3.15	77.0 3.03	1.2 0.04	0.8 0.03	34.4	9.9	0.0731	0.88 1.92
23.812 0.9375	17.462 0.6875	-5.6 -0.22	3.5 0.14	41.5 1.63	48.0 1.89	3.3 0.13	68.0 2.68	63.0 2.48	0.9 0.03	0.2 0.01	23.1	12.4	0.0718	0.42 0.93
25.400 1.0000	19.842 0.7812	-4.6 -0.18	3.5 0.14	42.5 1.67	54.0 2.13	2.3 0.09	69.0 2.72	60.0 2.36	1.6 0.06	1.8 0.07	23.4	9.4	0.0822	0.47 1.05
25.654 1.0100	19.050 0.7500	-8.1 -0.32	3.5 0.14	42.5 1.67	49.0 1.93	0.8 0.03	69.0 2.72	66.0 2.60	1.4 0.05	0.9 0.04	28.7	12.2	0.0725	0.47 1.03
24.608 0.9688	19.050 0.7500	-8.1 -0.32	1.5 0.06	42.0 1.65	44.0 1.73	0.8 0.03	68.0 2.68	65.0 2.56	0.9 0.03	1.6 0.07	26.4	10.9	0.0695	0.46 1.00
25.654 1.0100	19.050 0.7500	-8.1 -0.32	1.5 0.06	42.5 1.67	44.5 1.75	0.8 0.03	69.0 2.72	66.0 2.60	1.4 0.05	0.9 0.04	28.7	12.2	0.0725	0.47 1.04
24.608 0.9688	19.050 0.7500	-8.1 -0.32	1.5 0.06	42.0 1.65	44.0 1.73	2.3 0.09	68.0 2.68	64.0 2.52	0.9 0.03	1.6 0.07	26.4	10.9	0.0695	0.45 0.99
25.654 1.0100	19.050 0.7500	-8.1 -0.32	1.5 0.06	42.5 1.67	44.5 1.75	0.8 0.03	70.0 2.76	67.0 2.64	1.4 0.05	0.9 0.04	28.7	12.2	0.0725	0.50 1.10
25.654 1.0100	19.050 0.7500	-8.1 -0.32	3.5 0.14	42.5 1.67	49.0 1.93	3.3 0.13	70.0 2.76	66.0 2.60	1.4 0.05	0.9 0.04	28.7	12.2	0.0725	0.52 1.13
25.654 1.0100	19.050 0.7500	-8.1 -0.32	1.5 0.06	42.5 1.67	44.5 1.75	3.3 0.13	70.0 2.76	66.0 2.60	1.4 0.05	0.9 0.04	28.7	12.2	0.0725	0.52 1.14
25.654 1.0100	19.050 0.7500	-8.1 -0.32	1.5 0.06	42.5 1.67	44.5 1.75	0.8 0.03	70.0 2.76	68.0 2.68	1.4 0.05	0.9 0.04	28.7	12.2	0.0725	0.53 1.16
25.654 1.0100	19.050 0.7500	-8.1 -0.32	1.5 0.06	42.5 1.67	44.5 1.75	3.3 0.13	72.0 2.83	67.0 2.64	1.4 0.05	0.9 0.04	28.7	12.2	0.0725	0.58 1.27
16.520 0.6504	11.908 0.4688	-1.5 -0.06	1.5 0.06	41.5 1.63	44.0 1.73	1.5 0.06	65.0 2.56	61.0 2.40	1.1 0.04	1.6 0.06	17.5	11.5	0.0694	0.25 0.55
19.050 0.7500	15.083 0.5938	-3.0 -0.12	3.5 0.14	41.5 1.63	48.0 1.89	2.3 0.09	65.0 2.56	61.0 2.40	0.9 0.03	0.7 0.03	20.7	12.2	0.0713	0.29 0.65

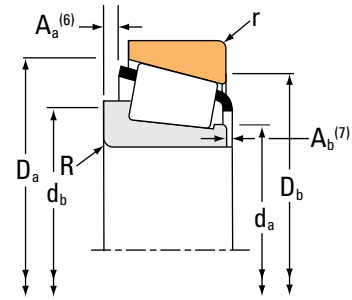
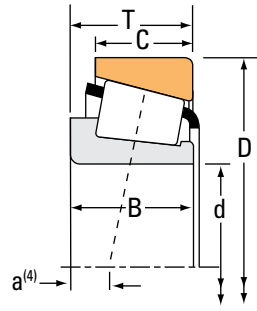
<sup>(4)</sup>Negative value indicates effective center inside cone (inner-ring) backface.  
<sup>(5)</sup>These maximum fillet radii will be cleared by the bearing corners.  
<sup>(6)</sup>Negative value indicates cage extends beyond cone (inner-ring) backface.  
<sup>(7)</sup>Negative value indicates cage that does not extend beyond cone (inner-ring) front face.

Continued on next page.

# TAPERED ROLLER BEARINGS

## SINGLE-ROW • TYPE TS

### TYPE TS



Bearing Dimensions			Load Ratings						Part Number			
Bore d	O.D. D	Width T	Dynamic <sup>(1)</sup>		Factors <sup>(2)</sup>		Dynamic <sup>(3)</sup>		Static		Inner	Outer
			C <sub>1</sub>	e	Y	C <sub>90</sub>	C <sub>a90</sub>	K	C <sub>0</sub>			
mm in.	mm in.	mm in.	N lbf			N lbf	N lbf		N lbf			
36.512 1.4375	72.000 2.8346	17.018 0.6700	50700 11400	0.44	1.35	13100 2960	10000 2250	1.31	57800 13000	19143	19283X	
36.512 1.4375	72.000 2.8346	17.018 0.6700	50700 11400	0.44	1.35	13100 2960	10000 2250	1.31	57800 13000	19143	19283	
36.512 1.4375	72.000 2.8346	19.000 0.7480	56600 12700	0.40	1.49	14700 3300	10100 2270	1.45	65800 14800	16143	16282	
36.512 1.4375	72.238 2.8440	20.638 0.8125	56600 12700	0.40	1.49	14700 3300	10100 2270	1.45	65800 14800	16143	16284	
36.512 1.4375	76.200 3.0000	29.370 1.1563	94700 21300	0.40	1.49	24600 5520	16900 3800	1.45	107000 24100	31597	31521	
36.512 1.4375	76.200 3.0000	29.370 1.1563	94700 21300	0.40	1.49	24600 5520	16900 3800	1.45	107000 24100	31597	31520	
36.512 1.4375	76.200 3.0000	29.370 1.1563	110000 24800	0.55	1.10	28600 6440	26800 6020	1.07	119000 26700	HM89449	HM89410	
36.512 1.4375	76.200 3.0000	29.370 1.1563	110000 24800	0.55	1.10	28600 6440	26800 6020	1.07	119000 26700	HM89449	HM89411	
36.512 1.4375	76.200 3.0000	29.370 1.1563	110000 24800	0.55	1.10	28600 6440	26800 6020	1.07	119000 26700	HM89448	HM89410	
36.512 1.4375	79.375 3.1250	29.370 1.1563	105000 23500	0.37	1.64	27100 6100	17000 3820	1.60	119000 26800	3479	3420	
36.512 1.4375	79.375 3.1250	29.370 1.1563	126000 28200	0.55	1.10	32600 7320	30400 6840	1.07	121000 27200	HM89249	HM89210	
36.512 1.4375	80.000 3.1496	23.812 0.9375	91100 20500	0.32	1.88	23600 5310	12900 2900	1.83	110000 24800	26877	26824	
36.512 1.4375	80.167 3.1562	25.400 1.0000	91100 20500	0.32	1.88	23600 5310	12900 2900	1.83	110000 24800	26877	26820	
36.512 1.4375	80.167 3.1562	29.370 1.1563	105000 23500	0.37	1.64	27100 6100	17000 3820	1.60	119000 26800	3479	3422	
36.512 1.4375	82.931 3.2650	23.812 0.9375	90500 20300	0.33	1.79	23500 5270	13500 3020	1.74	111000 24900	25570	25520	
36.512 1.4375	85.725 3.3750	30.162 1.1875	124000 27900	0.40	1.49	32200 7240	22200 4980	1.45	148000 33200	3878	3820	
36.512 1.4375	88.500 3.4843	25.400 1.0000	99800 22400	0.78	0.77	25900 5810	34600 7770	0.75	88600 19900	44143	44348	

<sup>(1)</sup>Based on 1 x 10<sup>6</sup> revolutions L<sub>10</sub> life, for the ISO life-calculation method.

<sup>(2)</sup>Consult your Timken engineer for instructions on use or review the Timken Engineering Manual on timken.com/catalogs.

<sup>(3)</sup>Based on 90 x 10<sup>6</sup> revolutions L<sub>10</sub> life, for The Timken Company life-calculation method. C<sub>90</sub> and C<sub>a90</sub> are radial and thrust values.

Bearing Dimensions											Geometry Factors			Bearing Weight
Width B	Width C	Eff. Ctr. a <sup>(4)</sup>	Shaft			Housing			Cage		G <sub>1</sub>	G <sub>2</sub>	C <sub>g</sub>	
			Max Shaft Fillet Radius R <sup>(5)</sup>	Backing Shoulder Dia. d <sub>a</sub> d <sub>b</sub>		Max Housing Fillet Radius r <sup>(5)</sup>	Backing Shoulder Dia. D <sub>a</sub> D <sub>b</sub>		A <sub>a</sub> <sup>(6)</sup>	A <sub>b</sub> <sup>(7)</sup>				
mm in.	mm in.	mm in.	mm in.	mm in.	mm in.	mm in.	mm in.	mm in.	mm in.	mm in.				kg lbs.
16.520 0.6504	14.288 0.5625	-1.5 -0.06	1.5 0.06	41.5 1.63	44.0 1.73	2.0 0.08	66.0 2.60	62.0 2.44	1.1 0.04	1.6 0.06	17.5	11.5	0.0694	0.31 0.68
16.520 0.6504	14.288 0.5625	-1.5 -0.06	1.5 0.06	41.5 1.63	44.0 1.73	1.5 0.06	66.0 2.60	63.0 2.48	1.1 0.04	1.6 0.06	17.5	11.5	0.0694	0.31 0.68
20.638 0.8125	14.237 0.5605	-4.1 -0.16	3.5 0.14	42.0 1.65	48.5 1.91	1.5 0.06	67.0 2.64	63.0 2.48	1.1 0.04	1.1 0.05	20.3	14.5	0.0707	0.34 0.76
20.638 0.8125	15.875 0.6250	-4.1 -0.16	3.5 0.14	42.0 1.65	48.5 1.91	1.3 0.05	67.0 2.64	63.0 2.48	1.1 0.04	1.1 0.05	20.3	14.5	0.0707	0.36 0.81
28.575 1.1250	23.812 0.9375	-7.6 -0.30	3.5 0.14	44.5 1.75	51.0 2.01	1.3 0.05	72.0 2.83	66.0 2.60	1.6 0.06	1.3 0.05	26.3	9.1	0.0773	0.60 1.33
28.575 1.1250	23.812 0.9375	-7.6 -0.30	3.5 0.14	44.5 1.75	51.0 2.01	3.3 0.13	72.0 2.83	64.0 2.52	1.6 0.06	1.3 0.05	26.3	9.1	0.0773	0.59 1.31
28.575 1.1250	23.020 0.9063	-5.6 -0.22	3.5 0.14	44.5 1.75	57.0 2.24	3.3 0.13	73.0 2.87	62.0 2.44	1.9 0.07	1.4 0.06	28.9	9.9	0.0883	0.62 1.37
28.575 1.1250	23.020 0.9063	-5.6 -0.22	3.5 0.14	44.5 1.75	57.0 2.24	0.8 0.03	73.0 2.87	65.0 2.56	1.9 0.07	1.4 0.06	28.9	9.9	0.0883	0.63 1.39
28.575 1.1250	23.020 0.9063	-5.6 -0.22	0.8 0.03	44.5 1.75	48.5 1.91	3.3 0.13	73.0 2.87	62.0 2.44	1.9 0.07	1.4 0.06	28.9	9.9	0.0883	0.62 1.38
29.771 1.1721	23.812 0.9375	-8.6 -0.34	0.8 0.03	44.5 1.75	45.5 1.79	3.3 0.13	74.0 2.91	67.0 2.64	1.4 0.05	1.0 0.04	29.9	11.2	0.0781	0.68 1.51
28.829 1.1350	22.664 0.8923	-5.8 -0.23	3.5 0.14	44.0 1.73	55.0 2.17	3.3 0.13	75.0 2.95	66.0 2.60	2.3 0.09	2.6 0.10	27.0	11.1	0.0861	0.70 1.53
25.400 1.0000	19.050 0.7500	-7.4 -0.29	0.8 0.03	43.0 1.69	44.0 1.73	1.3 0.05	74.0 2.91	70.0 2.76	1.4 0.05	1.3 0.05	32.8	13.3	0.0770	0.60 1.32
25.400 1.0000	20.638 0.8125	-7.4 -0.29	0.8 0.03	43.0 1.69	44.0 1.73	3.3 0.13	74.0 2.91	69.0 2.72	1.4 0.05	1.3 0.05	32.8	13.3	0.0770	0.61 1.36
29.771 1.1721	23.812 0.9375	-8.6 -0.34	0.8 0.03	44.5 1.75	45.5 1.79	3.3 0.13	74.0 2.91	68.0 2.68	1.4 0.05	1.0 0.04	29.9	11.2	0.0781	0.70 1.55
25.400 1.0000	19.050 0.7500	-6.4 -0.25	3.5 0.14	45.0 1.77	51.0 2.01	0.8 0.03	77.0 3.03	74.0 2.91	1.0 0.04	0.7 0.03	35.2	14.3	0.0801	0.66 1.45
30.162 1.1875	23.812 0.9375	-8.1 -0.32	0.8 0.03	47.0 1.85	48.0 1.89	3.3 0.13	81.0 3.19	73.0 2.87	1.4 0.05	2.2 0.09	37.8	13.5	0.0873	0.87 1.92
23.698 0.9330	17.462 0.6875	2.3 0.09	2.3 0.09	50.0 1.97	54.0 2.13	1.5 0.06	84.0 3.31	75.0 2.95	3.8 0.15	2.7 0.11	22.9	8.7	0.0899	0.73 1.60

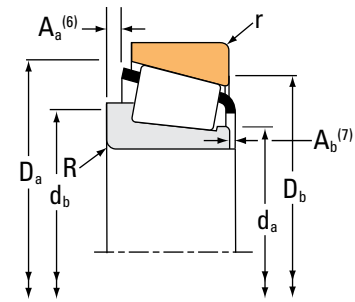
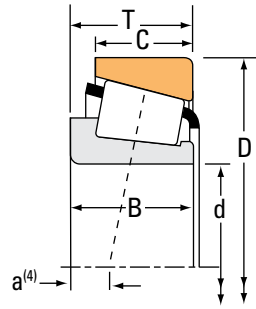
<sup>(4)</sup>Negative value indicates effective center inside cone (inner-ring) backface.  
<sup>(5)</sup>These maximum fillet radii will be cleared by the bearing corners.  
<sup>(6)</sup>Negative value indicates cage extends beyond cone (inner-ring) backface.  
<sup>(7)</sup>Negative value indicates cage that does not extend beyond cone (inner-ring) front face.

Continued on next page.

# TAPERED ROLLER BEARINGS

## SINGLE-ROW • TYPE TS

### TYPE TS



Bearing Dimensions			Load Ratings							Part Number			
Bore d	O.D. D	Width T	Dynamic <sup>(1)</sup>		Factors <sup>(2)</sup>		Dynamic <sup>(3)</sup>		Factors <sup>(2)</sup>		Static C <sub>0</sub>	Inner	Outer
			C <sub>1</sub>	e	Y	C <sub>90</sub>	C <sub>a90</sub>	K	N	N			
mm in.	mm in.	mm in.	N lbf			N lbf	N lbf		N lbf				
36.512 1.4375	93.662 3.6875	31.750 1.2500	129000 29100	0.40	1.49	33500 7540	23100 5190	1.45	158000 35500		46143	46368	
38.000 1.4961	63.000 2.4803	17.000 0.6693	51000 11500	0.42	1.44	13200 2970	9410 2120	1.40	55000 12400		JL69349	JL69310	
38.000 1.4961	63.000 2.4803	17.000 0.6693	51000 11500	0.42	1.44	13200 2970	9410 2120	1.40	55000 12400		JL69349A	JL69310	
38.000 1.4961	63.000 2.4803	17.000 0.6693	51000 11500	0.42	1.44	13200 2970	9410 2120	1.40	55000 12400		JL69348	JL69310	
38.000 1.4961	63.000 2.4803	17.000 0.6693	51000 11500	0.42	1.44	13200 2970	9410 2120	1.40	55000 12400		JL69349X	JL69310	
38.000 1.4961	68.000 2.6772	16.020 0.6307	50700 11400	0.44	1.35	13100 2960	10000 2250	1.31	57800 13000		19149X	19267X	
38.100 1.5000	63.500 2.5000	12.700 0.5000	27200 6100	0.35	1.73	7040 1580	4170 938	1.69	33000 7430		13889	13830	
38.100 1.5000	65.088 2.5625	12.700 0.5000	27200 6100	0.35	1.73	7040 1580	4170 938	1.69	33000 7430		13889	13836	
38.100 1.5000	65.088 2.5625	18.034 0.7100	48600 10900	0.33	1.80	12600 2830	7170 1610	1.76	60300 13600		LM29749	LM29710	
38.100 1.5000	65.088 2.5625	18.034 0.7100	48600 10900	0.33	1.80	12600 2830	7170 1610	1.76	60300 13600		LM29748	LM29710	
38.100 1.5000	65.088 2.5625	19.812 0.7800	48600 10900	0.33	1.80	12600 2830	7170 1610	1.76	60300 13600		LM29749	LM29711	
38.100 1.5000	68.262 2.6875	15.875 0.6250	50700 11400	0.44	1.35	13100 2960	10000 2250	1.31	57800 13000		19150	19268	
38.100 1.5000	68.262 2.6875	19.997 0.7873	50700 11400	0.44	1.35	13100 2960	10000 2250	1.31	57800 13000		19150	19269	
38.100 1.5000	69.012 2.7170	19.050 0.7500	67200 15100	0.40	1.49	17400 3920	12000 2700	1.45	67900 15300		13685	13621	
38.100 1.5000	69.012 2.7170	19.050 0.7500	67200 15100	0.40	1.49	17400 3920	12000 2700	1.45	67900 15300		13685A	13621	
38.100 1.5000	69.012 2.7170	19.050 0.7500	67200 15100	0.40	1.49	17400 3920	12000 2700	1.45	67900 15300		13685	13620	
38.100 1.5000	69.012 2.7170	19.050 0.7500	67200 15100	0.40	1.49	17400 3920	12000 2700	1.45	67900 15300		13687	13621	

<sup>(1)</sup>Based on 1 x 10<sup>6</sup> revolutions L<sub>10</sub> life, for the ISO life-calculation method.

<sup>(2)</sup>Consult your Timken engineer for instructions on use or review the Timken Engineering Manual on timken.com/catalogs.

<sup>(3)</sup>Based on 90 x 10<sup>6</sup> revolutions L<sub>10</sub> life, for The Timken Company life-calculation method. C<sub>90</sub> and C<sub>a90</sub> are radial and thrust values.

Bearing Dimensions											Geometry Factors			Bearing Weight
Width B	Width C	Eff. Ctr. a <sup>(4)</sup>	Shaft			Housing			Cage		G <sub>1</sub>	G <sub>2</sub>	C <sub>g</sub>	
			Max Shaft Fillet Radius R <sup>(5)</sup>	Backing Shoulder Dia. d <sub>a</sub> d <sub>b</sub>		Max Housing Fillet Radius r <sup>(5)</sup>	Backing Shoulder Dia. D <sub>a</sub> D <sub>b</sub>		A <sub>a</sub> <sup>(6)</sup>	A <sub>b</sub> <sup>(7)</sup>				
mm in.	mm in.	mm in.	mm in.	mm in.	mm in.	mm in.	mm in.	mm in.	mm in.	mm in.				kg lbs.
31.750 1.2500	26.195 1.0313	-7.9 -0.31	1.5 0.06	48.0 1.89	50.0 1.97	3.3 0.13	87.0 3.43	79.0 3.11	2.1 0.08	1.1 0.05	44.4	13.6	0.0920	1.15 2.53
17.000 0.6693	13.500 0.5315	-2.3 -0.09	0.0 0.00	42.5 1.67	46.5 1.83	1.3 0.05	60.0 2.36	56.0 2.20	0.5 0.02	1.4 0.06	18.4	13.6	0.0692	0.20 0.45
17.000 0.6693	13.500 0.5315	-2.3 -0.09	1.3 0.05	42.5 1.67	44.5 1.75	1.3 0.05	60.0 2.36	56.0 2.20	0.5 0.02	1.3 0.05	18.4	13.6	0.0692	0.20 0.45
17.000 0.6693	13.500 0.5315	-2.3 -0.09	3.3 0.13	42.5 1.67	46.5 1.83	1.3 0.05	60.0 2.36	56.0 2.20	0.5 0.02	1.4 0.06	18.4	13.6	0.0692	0.20 0.45
17.000 0.6693	13.500 0.5315	-2.3 -0.09	2.3 0.09	43.0 1.69	47.0 1.85	1.3 0.05	60.0 2.36	56.0 2.20	0.5 0.02	1.3 0.05	18.4	13.6	0.0692	0.20 0.45
16.520 0.6504	12.000 0.4724	-1.5 -0.06	2.0 0.08	43.0 1.69	46.0 1.81	1.5 0.06	64.0 2.52	61.0 2.40	1.1 0.04	1.6 0.06	17.5	11.5	0.0694	0.24 0.52
11.908 0.4688	9.525 0.3750	-0.8 -0.03	1.5 0.06	42.5 1.67	45.0 1.77	0.8 0.03	60.0 2.36	59.0 2.32	0.2 0.00	1.4 0.06	14.8	23.3	0.0601	0.14 0.33
11.908 0.4688	9.525 0.3750	-0.8 -0.03	1.5 0.06	42.5 1.67	45.0 1.77	0.8 0.03	61.0 2.40	59.0 2.32	0.2 0.00	1.4 0.06	14.8	23.3	0.0601	0.16 0.35
18.288 0.7200	13.970 0.5500	-4.1 -0.16	2.3 0.09	42.5 1.67	46.5 1.83	1.3 0.05	62.0 2.44	58.9 2.32	0.7 0.02	1.1 0.05	20.4	15.0	0.0666	0.24 0.51
18.288 0.7200	13.970 0.5500	-4.1 -0.16	3.5 0.14	42.5 1.67	49.0 1.93	1.3 0.05	62.0 2.44	58.9 2.32	0.7 0.02	1.1 0.05	20.4	15.0	0.0666	0.23 0.50
18.288 0.7200	15.748 0.6200	-4.1 -0.16	2.3 0.09	42.5 1.67	46.5 1.83	1.3 0.05	62.0 2.44	58.0 2.28	0.7 0.02	1.1 0.05	20.4	15.0	0.0666	0.25 0.55
16.520 0.6504	11.908 0.4688	-1.5 -0.06	1.5 0.06	43.0 1.69	45.0 1.77	1.5 0.06	65.0 2.56	61.0 2.40	1.1 0.04	1.6 0.06	17.5	11.5	0.0694	0.24 0.53
16.520 0.6504	16.030 0.6311	-1.5 -0.06	1.5 0.06	43.0 1.69	45.0 1.77	1.5 0.06	65.0 2.56	60.0 2.36	1.1 0.04	1.6 0.06	17.5	11.5	0.0694	0.28 0.61
19.050 0.7500	15.083 0.5938	-3.0 -0.12	3.5 0.14	43.0 1.69	49.5 1.95	2.3 0.09	65.0 2.56	61.0 2.40	0.9 0.03	0.7 0.03	20.7	12.2	0.0713	0.28 0.62
19.050 0.7500	15.083 0.5938	-3.0 -0.12	0.8 0.03	43.0 1.69	44.0 1.73	2.3 0.09	65.0 2.56	61.0 2.40	0.9 0.03	0.7 0.03	20.7	12.2	0.0713	0.29 0.63
19.050 0.7500	15.083 0.5938	-3.0 -0.12	3.5 0.14	43.0 1.69	49.5 1.95	0.8 0.03	65.0 2.56	62.0 2.44	0.9 0.03	0.7 0.03	20.7	12.2	0.0713	0.28 0.63
19.050 0.7500	15.083 0.5938	-3.0 -0.12	2.0 0.08	43.0 1.69	46.5 1.83	2.3 0.09	65.0 2.56	61.0 2.40	0.9 0.03	0.7 0.03	20.7	12.2	0.0713	0.28 0.63

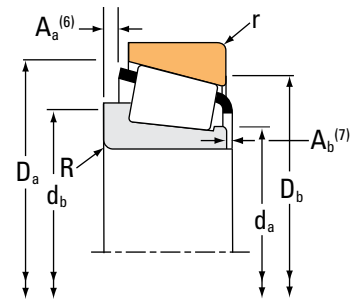
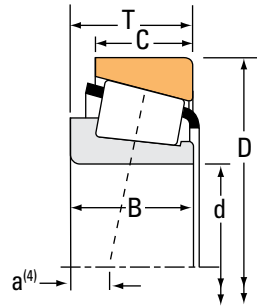
(4) Negative value indicates effective center inside cone (inner-ring) backface.  
 (5) These maximum fillet radii will be cleared by the bearing corners.  
 (6) Negative value indicates cage extends beyond cone (inner-ring) backface.  
 (7) Negative value indicates cage that does not extend beyond cone (inner-ring) front face.

Continued on next page.

# TAPERED ROLLER BEARINGS

## SINGLE-ROW • TYPE TS

### TYPE TS



Bearing Dimensions			Load Ratings							Part Number			
Bore d	O.D. D	Width T	Dynamic <sup>(1)</sup>		Factors <sup>(2)</sup>		Dynamic <sup>(3)</sup>		Factors <sup>(2)</sup>		Static C <sub>0</sub>	Inner	Outer
			C <sub>1</sub>	e	Y	C <sub>90</sub>	C <sub>a90</sub>	K	N	N			
mm in.	mm in.	mm in.	N lbf			N lbf	N lbf		N lbf				
38.100 1.5000	69.012 2.7170	19.050 0.7500	67200 15100	0.40	1.49	17400 3920	12000 2700	1.45	67900 15300			13687	13620
38.100 1.5000	69.012 2.7170	19.050 0.7500	67200 15100	0.40	1.49	17400 3920	12000 2700	1.45	67900 15300			13685A	13620
38.100 1.5000	69.012 2.7170	26.195 1.0313	67200 15100	0.40	1.49	17400 3920	12000 2700	1.45	67900 15300			13686	13621
38.100 1.5000	69.012 2.7170	26.195 1.0313	67200 15100	0.40	1.49	17400 3920	12000 2700	1.45	67900 15300			13686	13620
38.100 1.5000	69.969 2.7547	21.996 0.8660	67200 15100	0.40	1.49	17400 3920	12000 2700	1.45	67900 15300			13685	13624
38.100 1.5000	69.969 2.7547	21.996 0.8660	67200 15100	0.40	1.49	17400 3920	12000 2700	1.45	67900 15300			13687	13624
38.100 1.5000	71.438 2.8125	15.875 0.6250	50700 11400	0.44	1.35	13100 2960	10000 2250	1.31	57800 13000			19150	19281
38.100 1.5000	72.000 2.8346	17.018 0.6700	50700 11400	0.44	1.35	13100 2960	10000 2250	1.31	57800 13000			19150	19283
38.100 1.5000	72.000 2.8346	19.000 0.7480	56600 12700	0.40	1.49	14700 3300	10100 2270	1.45	65800 14800			16150	16282
38.100 1.5000	72.238 2.8440	20.638 0.8125	56600 12700	0.40	1.49	14700 3300	10100 2270	1.45	65800 14800			16150	16284
38.100 1.5000	72.238 2.8440	23.812 0.9375	56600 12700	0.40	1.49	14700 3300	10100 2270	1.45	65800 14800			16150	16283
38.100 1.5000	73.025 2.8750	23.812 0.9375	86900 19500	0.30	1.98	22500 5060	11700 2630	1.93	102000 23000			2788	2735X
38.100 1.5000	73.025 2.8750	23.812 0.9375	86900 19500	0.30	1.98	22500 5060	11700 2630	1.93	102000 23000			2788A	2735X
38.100 1.5000	73.025 2.8750	23.812 0.9375	86900 19500	0.30	1.98	22500 5060	11700 2630	1.93	102000 23000			2776	2735X
38.100 1.5000	74.612 2.9375	23.812 0.9375	86900 19500	0.30	1.98	22500 5060	11700 2630	1.93	102000 23000			2788A	2736
38.100 1.5000	76.200 3.0000	20.625 0.8120	75200 16900	0.40	1.49	19500 4390	13400 3020	1.45	68900 15500			28150	28300X
38.100 1.5000	76.200 3.0000	20.638 0.8125	63500 14300	0.40	1.49	16500 3700	11300 2550	1.45	68900 15500			28151	28300

<sup>(1)</sup>Based on 1 x 10<sup>6</sup> revolutions L<sub>10</sub> life, for the ISO life-calculation method.

<sup>(2)</sup>Consult your Timken engineer for instructions on use or review the Timken Engineering Manual on timken.com/catalogs.

<sup>(3)</sup>Based on 90 x 10<sup>6</sup> revolutions L<sub>10</sub> life, for The Timken Company life-calculation method. C<sub>90</sub> and C<sub>a90</sub> are radial and thrust values.



Bearing Dimensions											Geometry Factors			Bearing Weight
Width B	Width C	Eff. Ctr. a <sup>(4)</sup>	Shaft			Housing			Cage		G <sub>1</sub>	G <sub>2</sub>	C <sub>g</sub>	
			Max Shaft Fillet Radius R <sup>(5)</sup>	Backing Shoulder Dia. d <sub>a</sub>	Backing Shoulder Dia. d <sub>b</sub>	Max Housing Fillet Radius r <sup>(5)</sup>	Backing Shoulder Dia. D <sub>a</sub>	Backing Shoulder Dia. D <sub>b</sub>	A <sub>a</sub> <sup>(6)</sup>	A <sub>b</sub> <sup>(7)</sup>				
mm in.	mm in.	mm in.	mm in.	mm in.	mm in.	mm in.	mm in.	mm in.	mm in.	mm in.				kg lbs.
19.050 0.7500	15.083 0.5938	-3.0 -0.12	2.0 0.08	43.0 1.69	46.5 1.83	0.8 0.03	65.0 2.56	62.0 2.44	0.9 0.03	0.7 0.03	20.7	12.2	0.0713	0.28 0.64
19.050 0.7500	15.083 0.5938	-3.0 -0.12	0.8 0.03	43.0 1.69	44.0 1.73	0.8 0.03	65.0 2.56	62.0 2.44	0.9 0.03	0.7 0.03	20.7	12.2	0.0713	0.29 0.64
26.195 1.0313	15.083 0.5938	-10.2 -0.40	1.5 0.06	43.0 1.69	45.5 1.79	2.3 0.09	65.0 2.56	61.0 2.40	8.0 0.31	0.7 0.03	20.7	12.2	0.0713	0.35 0.76
26.195 1.0313	15.083 0.5938	-10.2 -0.40	1.5 0.06	43.0 1.69	45.5 1.79	0.8 0.03	65.0 2.56	62.0 2.44	8.0 0.31	0.7 0.03	20.7	12.2	0.0713	0.35 0.77
19.050 0.7500	18.029 0.7098	-3.0 -0.12	3.5 0.14	43.0 1.69	49.5 1.95	1.5 0.06	65.0 2.56	61.0 2.40	0.9 0.03	0.7 0.03	20.7	12.2	0.0713	0.33 0.73
19.050 0.7500	18.029 0.7098	-3.0 -0.12	2.0 0.08	43.0 1.69	46.5 1.83	1.5 0.06	65.0 2.56	61.0 2.40	0.9 0.03	0.7 0.03	20.7	12.2	0.0713	0.33 0.73
16.520 0.6504	11.908 0.4688	-1.5 -0.06	1.5 0.06	43.0 1.69	45.0 1.77	1.0 0.04	66.0 2.60	63.0 2.48	1.1 0.04	1.6 0.06	17.5	11.5	0.0694	0.28 0.60
16.520 0.6504	14.288 0.5625	-1.5 -0.06	1.5 0.06	43.0 1.69	45.0 1.77	1.5 0.06	66.0 2.60	63.0 2.48	1.1 0.04	1.6 0.06	17.5	11.5	0.0694	0.30 0.66
20.638 0.8125	14.237 0.5605	-4.1 -0.16	3.5 0.14	43.0 1.69	49.5 1.95	1.5 0.06	67.0 2.64	63.0 2.48	1.1 0.04	1.1 0.05	20.3	14.5	0.0707	0.33 0.73
20.638 0.8125	15.875 0.6250	-4.1 -0.16	3.5 0.14	43.0 1.69	49.5 1.95	1.3 0.05	67.0 2.64	63.0 2.48	1.1 0.04	1.1 0.05	20.3	14.5	0.0707	0.35 0.78
20.638 0.8125	19.050 0.7500	-4.1 -0.16	3.5 0.14	43.0 1.69	49.5 1.95	2.3 0.09	67.0 2.64	61.0 2.40	1.1 0.04	1.1 0.05	20.3	14.5	0.0707	0.39 0.86
25.654 1.0100	19.050 0.7500	-8.1 -0.32	3.5 0.14	43.5 1.71	50.0 1.97	0.8 0.03	69.0 2.72	66.0 2.60	1.4 0.05	0.9 0.04	28.7	12.2	0.0725	0.45 0.99
25.654 1.0100	19.050 0.7500	-8.1 -0.32	1.5 0.06	43.5 1.71	46.0 1.81	0.8 0.03	69.0 2.72	66.0 2.60	1.4 0.05	0.9 0.04	28.7	12.2	0.0725	0.45 1.00
25.654 1.0100	19.050 0.7500	-8.1 -0.32	4.3 0.17	43.5 1.71	52.0 2.05	0.8 0.03	69.0 2.72	66.0 2.60	1.4 0.05	0.9 0.04	28.7	12.2	0.0725	0.45 0.99
25.654 1.0100	19.050 0.7500	-8.1 -0.32	1.5 0.06	43.5 1.71	46.0 1.81	0.8 0.03	70.0 2.76	67.0 2.64	1.4 0.05	0.9 0.04	28.7	12.2	0.0725	0.48 1.06
20.940 0.8244	15.494 0.6100	-4.8 -0.19	1.5 0.06	43.5 1.71	45.5 1.79	1.5 0.06	71.0 2.80	68.0 2.68	2.3 0.09	1.1 0.05	20.7	12.5	0.0709	0.40 0.89
20.940 0.8244	15.507 0.6105	-4.8 -0.19	3.5 0.14	43.5 1.71	50.0 1.97	1.3 0.05	71.0 2.80	68.0 2.68	2.3 0.09	1.1 0.05	20.7	12.5	0.0709	0.39 0.87

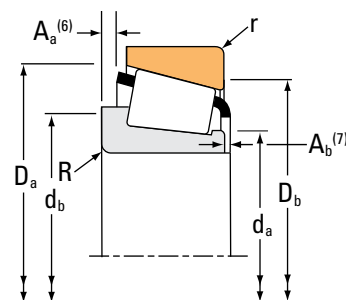
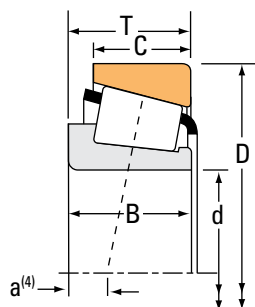
(4) Negative value indicates effective center inside cone (inner-ring) backface.  
 (5) These maximum fillet radii will be cleared by the bearing corners.  
 (6) Negative value indicates cage extends beyond cone (inner-ring) backface.  
 (7) Negative value indicates cage that does not extend beyond cone (inner-ring) front face.

Continued on next page.

# TAPERED ROLLER BEARINGS

## SINGLE-ROW • TYPE TS

### TYPE TS



Bearing Dimensions			Load Ratings						Part Number				
Bore d	O.D. D	Width T	Dynamic <sup>(1)</sup>		Factors <sup>(2)</sup>		Dynamic <sup>(3)</sup>		Factors <sup>(2)</sup>		Static C <sub>0</sub>	Inner	Outer
			C <sub>1</sub>	e	Y	C <sub>90</sub>	C <sub>a90</sub>	K	N	N			
mm in.	mm in.	mm in.	N lbf			N lbf	N lbf		N lbf				
38.100 1.5000	76.200 3.0000	20.638 0.8125	75200 16900	0.40	1.49	19500 4390	13400 3020	1.45	68900 15500		28150	28300	
38.100 1.5000	76.200 3.0000	23.812 0.9375	86900 19500	0.30	1.98	22500 5060	11700 2630	1.93	102000 23000		2788	2720	
38.100 1.5000	76.200 3.0000	23.812 0.9375	86900 19500	0.30	1.98	22500 5060	11700 2630	1.93	102000 23000		2788	2729X	
38.100 1.5000	76.200 3.0000	23.812 0.9375	86900 19500	0.30	1.98	22500 5060	11700 2630	1.93	102000 23000		2776	2720	
38.100 1.5000	76.200 3.0000	23.812 0.9375	86900 19500	0.30	1.98	22500 5060	11700 2630	1.93	102000 23000		2788A	2720	
38.100 1.5000	76.200 3.0000	23.812 0.9375	86900 19500	0.30	1.98	22500 5060	11700 2630	1.93	102000 23000		2788	2729	
38.100 1.5000	76.200 3.0000	23.812 0.9375	86900 19500	0.30	1.98	22500 5060	11700 2630	1.93	102000 23000		2777	2720	
38.100 1.5000	76.200 3.0000	23.812 0.9375	86900 19500	0.30	1.98	22500 5060	11700 2630	1.93	102000 23000		2788A	2729	
38.100 1.5000	76.200 3.0000	25.400 1.0000	91100 20500	0.32	1.88	23600 5310	12900 2900	1.83	110000 24800		26878	26823	
38.100 1.5000	79.375 3.1250	23.812 0.9375	91100 20500	0.32	1.88	23600 5310	12900 2900	1.83	110000 24800		26878	26822	
38.100 1.5000	79.375 3.1250	25.400 1.0000	86900 19500	0.30	1.98	22500 5060	11700 2630	1.93	102000 23000		2788	2734	
38.100 1.5000	79.375 3.1250	25.400 1.0000	86900 19500	0.30	1.98	22500 5060	11700 2630	1.93	102000 23000		2776	2734	
38.100 1.5000	79.375 3.1250	29.370 1.1563	105000 23500	0.37	1.64	27100 6100	17000 3820	1.60	119000 26800		3490	3420	
38.100 1.5000	79.975 3.1486	29.370 1.1563	115000 25800	0.27	2.20	29800 6700	13900 3130	2.14	129000 29100		3387	3325	
38.100 1.5000	80.000 3.1496	21.006 0.8270	75200 16900	0.40	1.49	19500 4390	13400 3020	1.45	68900 15500		28150	28315A	
38.100 1.5000	80.000 3.1496	23.812 0.9375	91100 20500	0.32	1.88	23600 5310	12900 2900	1.83	110000 24800		26878	26824	
38.100 1.5000	80.035 3.1510	24.608 0.9688	78000 17500	0.56	1.07	20200 4550	19400 4370	1.04	91100 20500		27880	27820	

<sup>(1)</sup>Based on 1 x 10<sup>6</sup> revolutions L<sub>10</sub> life, for the ISO life-calculation method.

<sup>(2)</sup>Consult your Timken engineer for instructions on use or review the Timken Engineering Manual on timken.com/catalogs.

<sup>(3)</sup>Based on 90 x 10<sup>6</sup> revolutions L<sub>10</sub> life, for The Timken Company life-calculation method. C<sub>90</sub> and C<sub>a90</sub> are radial and thrust values.

Bearing Dimensions											Geometry Factors			Bearing Weight
Width B	Width C	Eff. Ctr. a <sup>(4)</sup>	Shaft			Housing			Cage		G <sub>1</sub>	G <sub>2</sub>	C <sub>g</sub>	
			Max Shaft Fillet Radius R <sup>(5)</sup>	Backing Shoulder Dia. d <sub>a</sub>	Backing Shoulder Dia. d <sub>b</sub>	Max Housing Fillet Radius r <sup>(5)</sup>	Backing Shoulder Dia. D <sub>a</sub>	Backing Shoulder Dia. D <sub>b</sub>	A <sub>a</sub> <sup>(6)</sup>	A <sub>b</sub> <sup>(7)</sup>				
mm in.	mm in.	mm in.	mm in.	mm in.	mm in.	mm in.	mm in.	mm in.	mm in.	mm in.				kg lbs.
20.940 0.8244	15.507 0.6105	-4.8 -0.19	1.5 0.06	43.5 1.71	45.5 1.79	1.3 0.05	71.0 2.80	68.0 2.68	2.3 0.09	1.1 0.05	20.7	12.5	0.0709	0.40 0.88
25.654 1.0100	19.050 0.7500	-8.1 -0.32	3.5 0.14	43.5 1.71	50.0 1.97	3.3 0.13	70.0 2.76	66.0 2.60	1.4 0.05	0.9 0.04	28.7	12.2	0.0725	0.50 1.09
25.654 1.0100	19.050 0.7500	-8.1 -0.32	3.5 0.14	43.5 1.71	50.0 1.97	1.5 0.06	70.0 2.76	67.0 2.64	1.4 0.05	0.9 0.04	28.7	12.2	0.0725	0.51 1.11
25.654 1.0100	19.050 0.7500	-8.1 -0.32	4.3 0.17	43.5 1.71	52.0 2.05	3.3 0.13	70.0 2.76	66.0 2.60	1.4 0.05	0.9 0.04	28.7	12.2	0.0725	0.50 1.09
25.654 1.0100	19.050 0.7500	-8.1 -0.32	1.5 0.06	43.5 1.71	46.0 1.81	3.3 0.13	70.0 2.76	66.0 2.60	1.4 0.05	0.9 0.04	28.7	12.2	0.0725	0.50 1.10
25.654 1.0100	19.050 0.7500	-8.1 -0.32	3.5 0.14	43.5 1.71	50.0 1.97	0.8 0.03	70.0 2.76	68.0 2.68	1.4 0.05	0.9 0.04	28.7	12.2	0.0725	0.51 1.12
25.654 1.0100	19.050 0.7500	-8.1 -0.32	5.5 0.22	43.5 1.71	54.0 2.13	3.3 0.13	70.0 2.76	66.0 2.60	1.4 0.05	0.9 0.04	28.7	12.2	0.0725	0.49 1.07
25.654 1.0100	19.050 0.7500	-8.1 -0.32	1.5 0.06	43.5 1.71	46.0 1.81	0.8 0.03	70.0 2.76	68.0 2.68	1.4 0.05	0.9 0.04	28.7	12.2	0.0725	0.51 1.12
25.400 1.0000	20.638 0.8125	-7.4 -0.29	0.8 0.03	44.5 1.75	45.0 1.77	1.5 0.06	73.0 2.87	69.0 2.72	1.4 0.05	1.3 0.05	32.8	13.3	0.0770	0.52 1.16
25.400 1.0000	19.050 0.7500	-7.4 -0.29	0.8 0.03	44.5 1.75	45.0 1.77	0.8 0.03	74.0 2.91	71.0 2.80	1.4 0.05	1.3 0.05	32.8	13.3	0.0770	0.56 1.26
25.654 1.0100	20.638 0.8125	-8.1 -0.32	3.5 0.14	43.5 1.71	50.0 1.97	3.3 0.13	72.0 2.83	67.0 2.64	1.4 0.05	0.9 0.04	28.7	12.2	0.0725	0.58 1.28
25.654 1.0100	20.638 0.8125	-8.1 -0.32	4.3 0.17	43.5 1.71	52.0 2.05	3.3 0.13	72.0 2.83	67.0 2.64	1.4 0.05	0.9 0.04	28.7	12.2	0.0725	0.58 1.27
29.771 1.1721	23.812 0.9375	-8.6 -0.34	3.5 0.14	45.5 1.80	52.0 2.05	3.3 0.13	74.0 2.91	67.0 2.64	1.4 0.05	1.0 0.04	29.9	11.2	0.0781	0.65 1.44
30.391 1.1965	23.812 0.9375	-10.9 -0.43	0.8 0.03	44.5 1.75	45.0 1.77	3.3 0.13	74.8 2.94	70.0 2.76	1.8 0.07	1.1 0.05	34.6	12.1	0.0744	0.67 1.48
20.940 0.8244	15.875 0.6250	-4.8 -0.19	1.5 0.06	43.5 1.71	45.5 1.79	2.0 0.08	73.0 2.87	69.0 2.72	2.3 0.09	1.1 0.05	20.7	12.5	0.0709	0.46 1.01
25.400 1.0000	19.050 0.7500	-7.4 -0.29	0.8 0.03	44.5 1.75	45.0 1.77	1.3 0.05	74.0 2.91	70.0 2.76	1.4 0.05	1.3 0.05	32.8	13.3	0.0770	0.58 1.28
23.698 0.9330	18.512 0.7288	-2.5 -0.10	0.8 0.03	47.0 1.85	48.0 1.89	1.5 0.06	75.0 2.95	68.0 2.68	3.2 0.12	1.5 0.06	24.6	12.6	0.0839	0.56 1.23

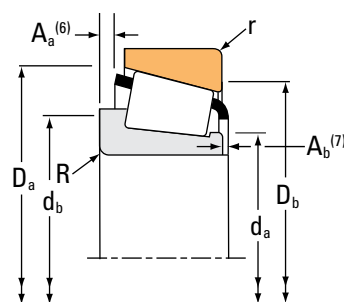
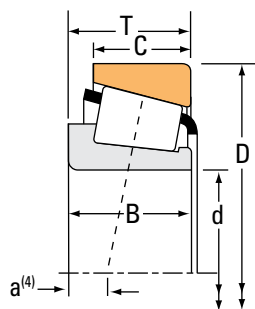
(4) Negative value indicates effective center inside cone (inner-ring) backface.  
 (5) These maximum fillet radii will be cleared by the bearing corners.  
 (6) Negative value indicates cage extends beyond cone (inner-ring) backface.  
 (7) Negative value indicates cage that does not extend beyond cone (inner-ring) front face.

Continued on next page.

# TAPERED ROLLER BEARINGS

## SINGLE-ROW • TYPE TS

### TYPE TS



Bearing Dimensions			Load Ratings							Part Number		
Bore d	O.D. D	Width T	Dynamic <sup>(1)</sup>		Factors <sup>(2)</sup>		Dynamic <sup>(3)</sup>		Factors <sup>(2)</sup>	Static	Inner	Outer
			C <sub>1</sub>	e	Y	C <sub>90</sub>	C <sub>a90</sub>	K	C <sub>0</sub>			
mm in.	mm in.	mm in.	N lbf			N lbf	N lbf			N lbf		
38.100 1.5000	80.035 3.1510	24.608 0.9688	78000 17500	0.56	1.07	20200 4550	19400 4370	1.04	91100 20500	27881	27820	
38.100 1.5000	80.035 3.1510	29.370 1.1563	115000 25800	0.27	2.20	29800 6700	13900 3130	2.14	129000 29100	3387	3339	
38.100 1.5000	80.167 3.1562	25.400 1.0000	91100 20500	0.32	1.88	23600 5310	12900 2900	1.83	110000 24800	26878	26820	
38.100 1.5000	80.167 3.1562	25.400 1.0000	91100 20500	0.32	1.88	23600 5310	12900 2900	1.83	110000 24800	26878	26830	
38.100 1.5000	80.167 3.1562	26.988 1.0625	79500 17900	0.27	2.20	20600 4640	9640 2170	2.14	83400 18700	347	3320	
38.100 1.5000	80.167 3.1562	29.370 1.1563	115000 25800	0.27	2.20	29800 6700	13900 3130	2.14	129000 29100	3381	3331	
38.100 1.5000	80.167 3.1562	29.370 1.1563	115000 25800	0.27	2.20	29800 6700	13900 3130	2.14	129000 29100	3381	3320	
38.100 1.5000	80.167 3.1562	29.370 1.1563	115000 25800	0.27	2.20	29800 6700	13900 3130	2.14	129000 29100	3387	3320	
38.100 1.5000	81.755 3.2187	29.370 1.1563	115000 25800	0.27	2.20	29800 6700	13900 3130	2.14	129000 29100	3381	3329	
38.100 1.5000	81.755 3.2187	29.370 1.1563	115000 25800	0.27	2.20	29800 6700	13900 3130	2.14	129000 29100	3387	3329	
38.100 1.5000	82.550 3.2500	29.370 1.1563	103000 23100	0.55	1.10	26600 5980	24900 5590	1.07	130000 29300	HM801346	HM801310	
38.100 1.5000	82.550 3.2500	29.370 1.1563	103000 23100	0.55	1.10	26600 5980	24900 5590	1.07	130000 29300	HM801346X	HM801310	
38.100 1.5000	82.550 3.2500	29.370 1.1563	103000 23100	0.55	1.10	26600 5980	24900 5590	1.07	130000 29300	HM801346	HM801311	
38.100 1.5000	82.931 3.2650	23.812 0.9375	90500 20300	0.33	1.79	23500 5270	13500 3020	1.74	111000 24900	25572	25520	
38.100 1.5000	85.000 3.3465	23.812 0.9375	90500 20300	0.33	1.79	23500 5270	13500 3020	1.74	111000 24900	25572	25526	
38.100 1.5000	85.725 3.3750	30.162 1.1875	124000 27900	0.40	1.49	32200 7240	22200 4980	1.45	148000 33200	3875	3820	
38.100 1.5000	85.725 3.3750	30.162 1.1875	124000 27900	0.40	1.49	32200 7240	22200 4980	1.45	148000 33200	3876	3821	

<sup>(1)</sup>Based on 1 x 10<sup>6</sup> revolutions L<sub>10</sub> life, for the ISO life-calculation method.

<sup>(2)</sup>Consult your Timken engineer for instructions on use or review the Timken Engineering Manual on timken.com/catalogs.

<sup>(3)</sup>Based on 90 x 10<sup>6</sup> revolutions L<sub>10</sub> life, for The Timken Company life-calculation method. C<sub>90</sub> and C<sub>a90</sub> are radial and thrust values.

Bearing Dimensions											Geometry Factors			Bearing Weight
Width B	Width C	Eff. Ctr. a <sup>(4)</sup>	Shaft			Housing			Cage		G <sub>1</sub>	G <sub>2</sub>	C <sub>g</sub>	
			Max Shaft Fillet Radius R <sup>(5)</sup>	Backing Shoulder Dia. d <sub>a</sub>	Backing Shoulder Dia. d <sub>b</sub>	Max Housing Fillet Radius r <sup>(5)</sup>	Backing Shoulder Dia. D <sub>a</sub>	Backing Shoulder Dia. D <sub>b</sub>	A <sub>a</sub> <sup>(6)</sup>	A <sub>b</sub> <sup>(7)</sup>				
mm in.	mm in.	mm in.	mm in.	mm in.	mm in.	mm in.	mm in.	mm in.	mm in.	mm in.				kg lbs.
23.698 0.9330	18.512 0.7288	-2.5 -0.10	3.5 0.14	47.0 1.85	53.0 2.09	1.5 0.06	75.0 2.95	68.0 2.68	3.2 0.12	1.5 0.06	24.6	12.6	0.0839	0.55 1.22
30.391 1.1965	23.812 0.9375	-10.9 -0.43	0.8 0.03	44.5 1.75	45.0 1.77	1.5 0.06	74.8 2.94	71.0 2.80	1.8 0.07	1.1 0.05	34.6	12.1	0.0744	0.67 1.50
25.400 1.0000	20.638 0.8125	-7.4 -0.29	0.8 0.03	44.5 1.75	45.0 1.77	3.3 0.13	74.0 2.91	69.0 2.72	1.4 0.05	1.3 0.05	32.8	13.3	0.0770	0.59 1.32
25.400 1.0000	20.638 0.8125	-7.4 -0.29	0.8 0.03	44.5 1.75	45.0 1.77	0.8 0.03	74.0 2.91	71.0 2.80	1.4 0.05	1.3 0.05	32.8	13.3	0.0770	0.60 1.34
22.403 0.8820	23.812 0.9375	-6.4 -0.25	3.5 0.14	44.0 1.73	50.0 1.97	3.3 0.13	75.0 2.95	70.0 2.76	0.7 0.02	1.1 0.05	26.5	13.0	0.0676	0.55 1.23
30.391 1.1965	23.812 0.9375	-10.9 -0.43	3.5 0.14	44.5 1.75	51.0 2.01	0.8 0.03	74.8 2.94	72.0 2.83	1.8 0.07	1.1 0.05	34.6	12.1	0.0744	0.68 1.51
30.391 1.1965	23.812 0.9375	-10.9 -0.43	3.5 0.14	44.5 1.75	51.0 2.01	3.3 0.13	75.0 2.95	70.0 2.76	1.8 0.07	1.1 0.05	34.6	12.1	0.0744	0.67 1.49
30.391 1.1965	23.812 0.9375	-10.9 -0.43	0.8 0.03	44.5 1.75	45.0 1.77	3.3 0.13	75.0 2.95	70.0 2.76	1.8 0.07	1.1 0.05	34.6	12.1	0.0744	0.67 1.49
30.391 1.1965	23.812 0.9375	-10.9 -0.43	3.5 0.14	44.5 1.75	51.0 2.01	3.3 0.13	75.0 2.95	71.0 2.80	1.8 0.07	1.1 0.05	34.6	12.1	0.0744	0.71 1.57
30.391 1.1965	23.812 0.9375	-10.9 -0.43	0.8 0.03	44.5 1.75	45.0 1.77	3.3 0.13	75.0 2.95	71.0 2.80	1.8 0.07	1.1 0.05	34.6	12.1	0.0744	0.71 1.57
28.575 1.1250	23.020 0.9063	-4.8 -0.19	0.8 0.03	49.1 1.93	51.0 2.01	3.3 0.13	78.0 3.07	68.0 2.68	2.1 0.08	1.9 0.08	33.7	14.0	0.0928	0.76 1.68
28.575 1.1250	23.020 0.9063	-4.8 -0.19	2.3 0.09	49.1 1.93	54.0 2.13	3.3 0.13	78.0 3.07	68.0 2.68	2.1 0.08	1.9 0.08	33.7	14.0	0.0928	0.76 1.68
28.575 1.1250	23.020 0.9063	-4.8 -0.19	0.8 0.03	49.1 1.93	51.0 2.01	0.8 0.03	78.0 3.07	70.0 2.76	2.1 0.08	1.9 0.08	33.7	14.0	0.0928	0.77 1.71
25.400 1.0000	19.050 0.7500	-6.4 -0.25	0.8 0.03	46.0 1.81	46.0 1.81	0.8 0.03	77.0 3.03	74.0 2.91	1.0 0.04	0.7 0.03	35.2	14.3	0.0801	0.65 1.42
25.400 1.0000	19.050 0.7500	-6.4 -0.25	0.8 0.03	46.0 1.81	46.0 1.81	2.3 0.09	78.0 3.07	74.0 2.91	1.0 0.04	0.7 0.03	35.2	14.3	0.0801	0.69 1.50
30.162 1.1875	23.812 0.9375	-8.1 -0.32	0.8 0.03	48.5 1.91	49.5 1.95	3.3 0.13	81.0 3.19	73.0 2.87	1.4 0.05	2.2 0.09	37.8	13.5	0.0873	0.85 1.87
30.162 1.1875	23.812 0.9375	-8.1 -0.32	3.5 0.14	48.5 1.91	55.0 2.17	1.3 0.05	81.0 3.19	75.0 2.95	1.4 0.05	2.2 0.09	37.8	13.5	0.0873	0.85 1.88

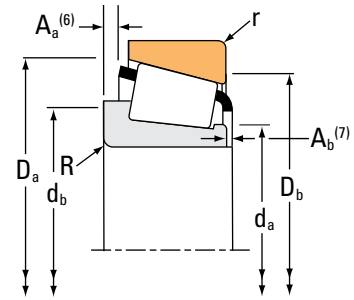
<sup>(4)</sup>Negative value indicates effective center inside cone (inner-ring) backface.  
<sup>(5)</sup>These maximum fillet radii will be cleared by the bearing corners.  
<sup>(6)</sup>Negative value indicates cage extends beyond cone (inner-ring) backface.  
<sup>(7)</sup>Negative value indicates cage that does not extend beyond cone (inner-ring) front face.

Continued on next page.

# TAPERED ROLLER BEARINGS

## SINGLE-ROW • TYPE TS

### TYPE TS



Bearing Dimensions			Load Ratings							Part Number			
Bore d	O.D. D	Width T	Dynamic <sup>(1)</sup>		Factors <sup>(2)</sup>		Dynamic <sup>(3)</sup>		Factors <sup>(2)</sup>		Static C <sub>0</sub>	Inner	Outer
			C <sub>1</sub>	e	Y	C <sub>90</sub>	C <sub>a90</sub>	K	N	N			
mm in.	mm in.	mm in.	N lbf			N lbf	N lbf		N lbf				
38.100 1.5000	85.725 3.3750	30.162 1.1875	124000 27900	0.40	1.49	32200 7240	22200 4980	1.45	148000 33200		3876	3820	
38.100 1.5000	87.312 3.4375	30.162 1.1875	113000 25500	0.31	1.96	29400 6610	15400 3460	1.91	134000 30100		3580	3525	
38.100 1.5000	87.312 3.4375	30.162 1.1875	113000 25500	0.31	1.96	29400 6610	15400 3460	1.91	134000 30100		3583	3525	
38.100 1.5000	88.500 3.4843	25.400 1.0000	99800 22400	0.78	0.77	25900 5810	34600 7770	0.75	88600 19900		44150	44348	
38.100 1.5000	88.500 3.4843	26.988 1.0625	116000 26000	0.26	2.28	30000 6740	13500 3040	2.22	124000 28000		418	414	
38.100 1.5000	88.500 3.4843	26.988 1.0625	116000 26000	0.26	2.28	30000 6740	13500 3040	2.22	124000 28000		418	414A	
38.100 1.5000	88.900 3.5000	26.988 1.0625	116000 26000	0.26	2.28	30000 6740	13500 3040	2.22	124000 28000		418	414X	
38.100 1.5000	90.488 3.5625	39.688 1.5625	199000 44700	0.28	2.11	51500 11600	25100 5640	2.05	204000 45900		4375	4335	
38.100 1.5000	93.662 3.6875	31.750 1.2500	136000 30500	0.36	1.67	35200 7900	21700 4870	1.62	156000 35000		49151	49368	
38.100 1.5000	95.250 3.7500	27.782 1.0938	127000 28500	0.28	2.11	32900 7400	16000 3600	2.05	144000 32400		440	432	
38.100 1.5000	95.250 3.7500	27.783 1.0938	127000 28500	0.28	2.11	32900 7400	16000 3600	2.05	144000 32400		444	432	
38.100 1.5000	95.250 3.7500	27.783 1.0938	130000 29200	0.33	1.82	33600 7560	19000 4270	1.77	161000 36200		33880	33821	
38.100 1.5000	95.250 3.7500	30.958 1.2188	119000 26700	0.74	0.81	30800 6920	39000 8760	0.79	104000 23400		53150	53375	
38.100 1.5000	98.425 3.8750	30.958 1.2188	119000 26700	0.74	0.81	30800 6920	39000 8760	0.79	104000 23400		53150	53387	
38.100 1.5000	101.600 4.0000	34.925 1.3750	165000 37000	0.29	2.10	42700 9600	20800 4690	2.05	191000 43000		525	522	
38.100 1.5000	101.600 4.0000	34.925 1.3750	165000 37000	0.29	2.10	42700 9600	20800 4690	2.05	191000 43000		525X	522	
38.100 1.5000	103.188 4.0625	38.100 1.5000	172000 38700	0.30	2.02	44600 10000	22700 5090	1.97	206000 46200		542	533A	

<sup>(1)</sup>Based on 1 x 10<sup>6</sup> revolutions L<sub>10</sub> life, for the ISO life-calculation method.

<sup>(2)</sup>Consult your Timken engineer for instructions on use or review the Timken Engineering Manual on timken.com/catalogs.

<sup>(3)</sup>Based on 90 x 10<sup>6</sup> revolutions L<sub>10</sub> life, for The Timken Company life-calculation method. C<sub>90</sub> and C<sub>a90</sub> are radial and thrust values.

Bearing Dimensions											Geometry Factors			Bearing Weight
Width B	Width C	Eff. Ctr. a <sup>(4)</sup>	Shaft			Housing			Cage		G <sub>1</sub>	G <sub>2</sub>	C <sub>g</sub>	
			Max Shaft Fillet Radius R <sup>(5)</sup>	Backing Shoulder Dia. d <sub>a</sub>	Shoulder Dia. d <sub>b</sub>	Max Housing Fillet Radius r <sup>(5)</sup>	Backing Shoulder Dia. D <sub>a</sub>	Shoulder Dia. D <sub>b</sub>	A <sub>a</sub> <sup>(6)</sup>	A <sub>b</sub> <sup>(7)</sup>				
mm in.	mm in.	mm in.	mm in.	mm in.	mm in.	mm in.	mm in.	mm in.	mm in.	mm in.				kg lbs.
30.162 1.1875	23.812 0.9375	-8.1 -0.32	3.5 0.14	48.5 1.91	55.0 2.17	3.3 0.13	81.0 3.19	73.0 2.87	1.4 0.05	2.2 0.09	37.8	13.5	0.0873	0.84 1.86
30.886 1.2160	23.812 0.9375	-10.2 -0.40	1.5 0.06	45.5 1.79	48.0 1.89	3.3 0.13	81.0 3.19	75.0 2.95	2.2 0.09	0.7 0.03	39.5	12.5	0.0808	0.88 1.91
30.886 1.2160	23.812 0.9375	-10.2 -0.40	3.5 0.14	45.5 1.79	52.0 2.05	3.3 0.13	81.0 3.19	75.0 2.95	2.2 0.09	0.7 0.03	39.5	12.5	0.0808	0.87 1.90
23.698 0.9330	17.462 0.6875	2.3 0.09	2.3 0.09	50.8 2.00	55.0 2.17	1.5 0.06	84.0 3.31	75.0 2.95	3.8 0.15	2.7 0.11	22.9	8.7	0.0899	0.71 1.56
29.083 1.1450	22.225 0.8750	-9.7 -0.38	3.5 0.14	44.5 1.75	51.0 2.01	1.5 0.06	80.0 3.15	77.0 3.03	1.2 0.04	0.8 0.03	34.4	9.9	0.0731	0.83 1.81
29.083 1.1450	22.225 0.8750	-9.7 -0.38	3.5 0.14	44.5 1.75	51.0 2.01	3.3 0.13	80.0 3.15	76.0 2.99	1.2 0.04	0.8 0.03	34.4	9.9	0.0731	0.82 1.80
29.083 1.1450	22.225 0.8750	-9.7 -0.38	3.5 0.14	44.5 1.75	51.0 2.01	0.8 0.03	80.0 3.15	77.5 3.07	1.2 0.04	0.8 0.03	34.4	9.9	0.0731	0.84 1.84
40.386 1.5900	33.338 1.3125	-15.0 -0.59	1.5 0.06	51.0 2.01	53.0 2.09	3.3 0.13	85.0 3.35	77.0 3.03	2.2 0.09	0.6 0.03	52.9	14.3	0.0872	1.31 2.89
31.750 1.2500	25.400 1.0000	-9.1 -0.36	0.8 0.03	48.0 1.89	48.5 1.91	3.3 0.13	87.0 3.43	82.0 3.23	2.9 0.11	0.8 0.04	42.4	13.6	0.0872	1.09 2.39
29.900 1.1772	22.225 0.8750	-9.1 -0.36	0.8 0.03	45.5 1.79	46.5 1.83	2.3 0.09	87.0 3.43	83.0 3.27	1.6 0.06	0.5 0.02	42.5	11.3	0.0805	1.04 2.29
29.900 1.1772	22.225 0.8750	-9.1 -0.36	3.5 0.14	45.5 1.79	52.0 2.05	2.3 0.09	87.0 3.43	83.0 3.27	1.6 0.06	0.5 0.02	42.5	11.3	0.0805	1.03 2.27
28.575 1.1250	22.225 0.8750	-7.6 -0.30	3.5 0.14	48.0 1.89	54.0 2.13	2.3 0.09	90.0 3.54	85.0 3.35	1.3 0.05	2.2 0.09	52.5	18.5	0.0910	1.05 2.31
28.300 1.1142	20.638 0.8125	-0.3 -0.01	1.5 0.06	52.7 2.07	55.0 2.17	0.8 0.03	89.0 3.50	81.0 3.19	5.7 0.22	2.2 0.09	26.7	9.6	0.0930	1.01 2.25
28.300 1.1142	20.638 0.8125	-0.3 -0.01	1.5 0.06	52.7 2.07	55.0 2.17	0.8 0.03	91.0 3.58	82.0 3.23	5.7 0.22	2.2 0.09	26.7	9.6	0.0930	1.09 2.42
36.068 1.4200	26.988 1.0625	-12.7 -0.50	3.5 0.14	48.0 1.89	54.0 2.13	3.3 0.13	95.0 3.74	89.0 3.50	2.7 0.10	1.8 0.07	57.9	13.4	0.0894	1.48 3.26
36.068 1.4200	26.988 1.0625	-12.7 -0.50	0.8 0.03	48.0 1.89	49.0 1.93	3.3 0.13	95.0 3.74	89.0 3.50	2.7 0.10	1.8 0.07	57.9	13.4	0.0894	1.49 3.28
36.957 1.4550	30.162 1.1875	-12.2 -0.48	3.5 0.14	49.0 1.93	55.0 2.17	1.5 0.06	98.0 3.86	93.0 3.66	2.7 0.10	1.0 0.04	64.3	16.1	0.0938	1.65 3.63

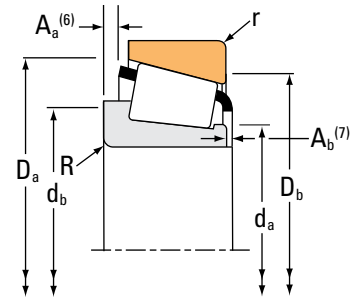
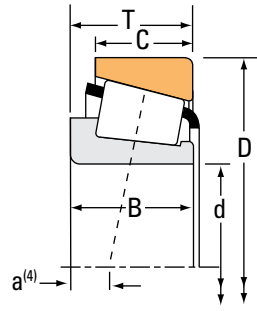
<sup>(4)</sup>Negative value indicates effective center inside cone (inner-ring) backface.  
<sup>(5)</sup>These maximum fillet radii will be cleared by the bearing corners.  
<sup>(6)</sup>Negative value indicates cage extends beyond cone (inner-ring) backface.  
<sup>(7)</sup>Negative value indicates cage that does not extend beyond cone (inner-ring) front face.

Continued on next page.

# TAPERED ROLLER BEARINGS

## SINGLE-ROW • TYPE TS

### TYPE TS



Bearing Dimensions			Load Ratings							Part Number			
Bore d	O.D. D	Width T	Dynamic <sup>(1)</sup>		Factors <sup>(2)</sup>		Dynamic <sup>(3)</sup>		Factors <sup>(2)</sup>		Static C <sub>0</sub>	Inner	Outer
			C <sub>1</sub>	e	Y	C <sub>90</sub>	C <sub>a90</sub>	K	N	N			
mm in.	mm in.	mm in.	N lbf			N lbf	N lbf		N lbf				
38.100 1.5000	107.950 4.2500	27.783 1.0938	136000 30500	0.34	1.79	35200 7900	20200 4540	1.74	166000 37200		455A	453A	
38.100 1.5000	111.125 4.3750	38.100 1.5000	172000 38700	0.30	2.02	44600 10000	22700 5090	1.97	206000 46200		542	532A	
38.481 1.5150	63.500 2.5000	12.700 0.5000	27200 6100	0.35	1.73	7040 1580	4170 938	1.69	33000 7430		13890	13830	
38.481 1.5150	65.088 2.5625	12.700 0.5000	27200 6100	0.35	1.73	7040 1580	4170 938	1.69	33000 7430		13890	13836	
39.000 1.5354	72.014 2.8352	21.400 0.8425	56600 12700	0.40	1.49	14700 3300	10100 2270	1.45	65800 14800		J16154	J16285	
39.687 1.5625	73.025 2.8750	16.667 0.6562	50800 11400	0.35	1.71	13200 2960	7890 1770	1.67	58100 13100		18587	18520	
39.687 1.5625	73.025 2.8750	23.812 0.9375	86900 19500	0.30	1.98	22500 5060	11700 2630	1.93	102000 23000		2789	2735X	
39.687 1.5625	73.025 2.8750	25.654 1.0100	73400 16500	0.33	1.80	19000 4280	10800 2440	1.76	89100 20000		M201047	M201011	
39.687 1.5625	76.200 3.0000	23.812 0.9375	86900 19500	0.30	1.98	22500 5060	11700 2630	1.93	102000 23000		2789	2720	
39.687 1.5625	76.200 3.0000	23.812 0.9375	86900 19500	0.30	1.98	22500 5060	11700 2630	1.93	102000 23000		2789	2729	
39.687 1.5625	76.200 3.0000	25.400 1.0000	91100 20500	0.32	1.88	23600 5310	12900 2900	1.83	110000 24800		26881	26823	
39.687 1.5625	79.375 3.1250	23.812 0.9375	91100 20500	0.32	1.88	23600 5310	12900 2900	1.83	110000 24800		26880	26822	
39.687 1.5625	79.375 3.1250	23.812 0.9375	91100 20500	0.32	1.88	23600 5310	12900 2900	1.83	110000 24800		26881	26822	
39.687 1.5625	79.375 3.1250	23.812 0.9375	91100 20500	0.32	1.88	23600 5310	12900 2900	1.83	110000 24800		26880	26822A	
39.688 1.5625	79.975 3.1486	29.370 1.1563	115000 25800	0.27	2.20	29800 6700	13900 3130	2.14	129000 29100		3382	3325	
39.688 1.5625	79.975 3.1486	29.370 1.1563	115000 25800	0.27	2.20	29800 6700	13900 3130	2.14	129000 29100		3386	3325	
39.687 1.5625	80.000 3.1496	23.812 0.9375	91100 20500	0.32	1.88	23600 5310	12900 2900	1.83	110000 24800		26881	26824	

<sup>(1)</sup>Based on 1 x 10<sup>6</sup> revolutions L<sub>10</sub> life, for the ISO life-calculation method.

<sup>(2)</sup>Consult your Timken engineer for instructions on use or review the Timken Engineering Manual on timken.com/catalogs.

<sup>(3)</sup>Based on 90 x 10<sup>6</sup> revolutions L<sub>10</sub> life, for The Timken Company life-calculation method. C<sub>90</sub> and C<sub>a90</sub> are radial and thrust values.



Bearing Dimensions											Geometry Factors			Bearing Weight
Width B	Width C	Eff. Ctr. a <sup>(4)</sup>	Shaft			Housing			Cage		G <sub>1</sub>	G <sub>2</sub>	C <sub>g</sub>	
			Max Shaft Fillet Radius R <sup>(5)</sup>	Backing Shoulder Dia. d <sub>a</sub>	mm in.	Max Housing Fillet Radius r <sup>(5)</sup>	Backing Shoulder Dia. D <sub>a</sub>	mm in.	A <sub>a</sub> <sup>(6)</sup>	A <sub>b</sub> <sup>(7)</sup>				
mm in.	mm in.	mm in.	mm in.	mm in.	mm in.	mm in.	mm in.	mm in.	mm in.	mm in.			kg lbs.	
29.317 1.1542	22.225 0.8750	-7.1 -0.28	3.5 0.14	49.5 1.95	56.0 2.20	0.8 0.03	100.0 3.94	97.0 3.82	2.1 0.08	1.4 0.06	58.6	17.1	0.0946	1.43 3.14
36.957 1.4550	30.162 1.1875	-12.2 -0.48	3.5 0.14	49.0 1.93	55.0 2.17	3.3 0.13	100.0 3.94	95.0 3.74	2.7 0.10	1.0 0.04	64.3	16.1	0.0938	1.96 4.30
11.908 0.4688	9.525 0.3750	-0.8 -0.03	0.4 0.02	43.0 1.69	43.0 1.69	0.8 0.03	60.0 2.36	59.0 2.32	0.2 0.00	1.4 0.06	14.8	23.3	0.0601	0.14 0.32
11.908 0.4688	9.525 0.3750	-0.8 -0.03	0.4 0.02	43.0 1.69	43.0 1.69	0.8 0.03	61.0 2.40	59.0 2.32	0.2 0.00	1.4 0.06	14.8	23.3	0.0601	0.16 0.35
20.638 0.8125	16.637 0.6550	-4.1 -0.16	3.5 0.14	44.5 1.75	51.0 2.01	0.4 0.02	67.0 2.64	63.0 2.48	1.1 0.04	1.1 0.05	20.3	14.5	0.0707	0.35 0.79
17.462 0.6875	12.700 0.5000	-2.8 -0.11	0.8 0.03	45.0 1.77	45.5 1.79	1.5 0.06	69.0 2.72	66.0 2.60	0.4 0.01	1.3 0.05	21.0	16.8	0.0681	0.30 0.65
25.654 1.0100	19.050 0.7500	-8.1 -0.32	3.5 0.14	45.0 1.77	52.0 2.05	0.8 0.03	69.0 2.72	66.0 2.60	1.4 0.05	0.9 0.04	28.7	12.2	0.0725	0.43 0.95
22.098 0.8700	21.336 0.8400	-5.8 -0.23	0.8 0.03	48.0 1.89	45.5 1.79	2.3 0.09	69.0 2.72	64.0 2.52	0.4 0.01	2.0 0.08	27.5	15.0	0.0736	0.44 0.94
25.654 1.0100	19.050 0.7500	-8.1 -0.32	3.5 0.14	45.0 1.77	52.0 2.05	3.3 0.13	70.0 2.76	66.0 2.60	1.4 0.05	0.9 0.04	28.7	12.2	0.0725	0.48 1.05
25.654 1.0100	19.050 0.7500	-8.1 -0.32	3.5 0.14	45.0 1.77	52.0 2.05	0.8 0.03	70.0 2.76	68.0 2.68	1.4 0.05	0.9 0.04	28.7	12.2	0.0725	0.49 1.07
25.400 1.0000	20.638 0.8125	-7.4 -0.29	3.5 0.14	45.5 1.79	52.0 2.05	1.5 0.06	73.0 2.87	69.0 2.72	1.4 0.05	1.3 0.05	32.8	13.3	0.0770	0.50 1.10
25.400 1.0000	19.050 0.7500	-7.4 -0.29	1.5 0.06	45.5 1.79	48.0 1.89	0.8 0.03	74.0 2.91	71.0 2.80	1.4 0.05	1.3 0.05	32.8	13.3	0.0770	0.54 1.21
25.400 1.0000	19.050 0.7500	-7.4 -0.29	3.5 0.14	45.5 1.79	52.0 2.05	0.8 0.03	74.0 2.91	71.0 2.80	1.4 0.05	1.3 0.05	32.8	13.3	0.0770	0.54 1.20
25.400 1.0000	19.050 0.7500	-7.4 -0.29	1.5 0.06	45.5 1.79	48.0 1.89	2.3 0.09	74.0 2.91	69.0 2.72	1.4 0.05	1.3 0.05	32.8	13.3	0.0770	0.54 1.20
30.391 1.1965	23.812 0.9375	-10.9 -0.43	3.5 0.14	45.5 1.79	52.0 2.05	3.3 0.13	74.8 2.94	70.0 2.76	1.8 0.07	1.1 0.05	34.6	12.1	0.0744	0.65 1.43
30.391 1.1965	23.812 0.9375	-10.9 -0.43	0.8 0.03	45.5 1.79	46.5 1.83	3.3 0.13	74.8 2.94	70.0 2.76	1.8 0.07	1.1 0.05	34.6	12.1	0.0744	0.65 1.43
25.400 1.0000	19.050 0.7500	-7.4 -0.29	3.5 0.14	45.5 1.79	52.0 2.05	1.3 0.05	74.0 2.91	70.0 2.76	1.4 0.05	1.3 0.05	32.8	13.3	0.0770	0.56 1.22

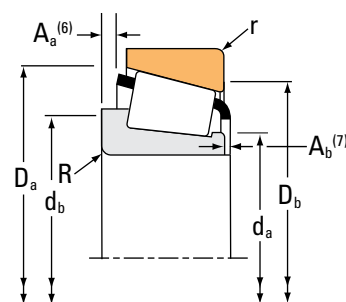
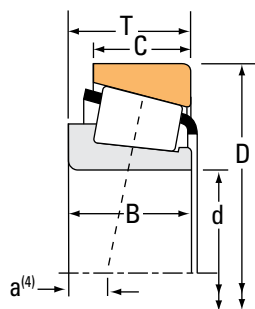
<sup>(4)</sup>Negative value indicates effective center inside cone (inner-ring) backface.  
<sup>(5)</sup>These maximum fillet radii will be cleared by the bearing corners.  
<sup>(6)</sup>Negative value indicates cage extends beyond cone (inner-ring) backface.  
<sup>(7)</sup>Negative value indicates cage that does not extend beyond cone (inner-ring) front face.

Continued on next page.

# TAPERED ROLLER BEARINGS

## SINGLE-ROW • TYPE TS

### TYPE TS



Bearing Dimensions			Load Ratings							Part Number		
Bore d	O.D. D	Width T	Dynamic <sup>(1)</sup>		Factors <sup>(2)</sup>		Dynamic <sup>(3)</sup>		Factors <sup>(2)</sup>	Static	Inner	Outer
			C <sub>1</sub>	e	Y	C <sub>90</sub>	C <sub>a90</sub>	K	C <sub>0</sub>			
mm in.	mm in.	mm in.	N lbf			N lbf	N lbf			N lbf		
39.688 1.5625	80.035 3.1510	29.370 1.1563	115000 25800	0.27	2.20	29800 6700	13900 3130	2.14		129000 29100	3386	3339
39.687 1.5625	80.167 3.1562	25.400 1.0000	91100 20500	0.32	1.88	23600 5310	12900 2900	1.83		110000 24800	26881	26820
39.687 1.5625	80.167 3.1562	25.400 1.0000	91100 20500	0.32	1.88	23600 5310	12900 2900	1.83		110000 24800	26880	26830
39.687 1.5625	80.167 3.1562	25.400 1.0000	91100 20500	0.32	1.88	23600 5310	12900 2900	1.83		110000 24800	26880	26820
39.687 1.5625	80.167 3.1562	25.400 1.0000	91100 20500	0.32	1.88	23600 5310	12900 2900	1.83		110000 24800	26881	26830
39.687 1.5625	80.167 3.1562	29.370 1.1563	91100 20500	0.32	1.88	23600 5310	12900 2900	1.83		110000 24800	26880	26821
39.688 1.5625	80.167 3.1562	29.370 1.1563	115000 25800	0.27	2.20	29800 6700	13900 3130	2.14		129000 29100	3382	3331
39.688 1.5625	80.167 3.1562	29.370 1.1563	115000 25800	0.27	2.20	29800 6700	13900 3130	2.14		129000 29100	3382	3320
39.688 1.5625	80.167 3.1562	29.370 1.1563	115000 25800	0.27	2.20	29800 6700	13900 3130	2.14		129000 29100	3386	3331
39.688 1.5625	80.167 3.1562	29.370 1.1563	115000 25800	0.27	2.20	29800 6700	13900 3130	2.14		129000 29100	3386	3320
39.688 1.5625	84.138 3.3125	29.370 1.1563	115000 25800	0.27	2.20	29800 6700	13900 3130	2.14		129000 29100	3386	3328
39.688 1.5625	84.138 3.3125	29.370 1.1563	115000 25800	0.27	2.20	29800 6700	13900 3130	2.14		129000 29100	3382	3328
39.687 1.5625	88.500 3.4843	25.400 1.0000	99800 22400	0.78	0.77	25900 5810	34600 7770	0.75		88600 19900	44156	44348
39.687 1.5625	88.500 3.4843	25.400 1.0000	99800 22400	0.78	0.77	25900 5810	34600 7770	0.75		88600 19900	44158	44348
39.687 1.5625	120.650 4.7500	41.275 1.6250	207000 46600	0.31	1.91	53800 12100	28900 6510	1.86		244000 54800	620	612
39.980 1.5740	76.200 3.0000	19.347 0.7617	75200 16900	0.40	1.49	19500 4390	13400 3020	1.45		68900 15500	28156	28300
39.980 1.5740	76.200 3.0000	20.638 0.8125	63500 14300	0.40	1.49	16500 3700	11300 2550	1.45		68900 15500	28159	28300

<sup>(1)</sup>Based on 1 x 10<sup>6</sup> revolutions L<sub>10</sub> life, for the ISO life-calculation method.

<sup>(2)</sup>Consult your Timken engineer for instructions on use or review the Timken Engineering Manual on timken.com/catalogs.

<sup>(3)</sup>Based on 90 x 10<sup>6</sup> revolutions L<sub>10</sub> life, for The Timken Company life-calculation method. C<sub>90</sub> and C<sub>a90</sub> are radial and thrust values.

Bearing Dimensions											Geometry Factors			Bearing Weight
Width B	Width C	Eff. Ctr. a <sup>(4)</sup>	Shaft			Housing			Cage		G <sub>1</sub>	G <sub>2</sub>	C <sub>g</sub>	
			Max Shaft Fillet Radius R <sup>(5)</sup>	Backing Shoulder Dia. d <sub>a</sub>	Backing Shoulder Dia. d <sub>b</sub>	Max Housing Fillet Radius r <sup>(5)</sup>	Backing Shoulder Dia. D <sub>a</sub>	Backing Shoulder Dia. D <sub>b</sub>	A <sub>a</sub> <sup>(6)</sup>	A <sub>b</sub> <sup>(7)</sup>				
mm in.	mm in.	mm in.	mm in.	mm in.	mm in.	mm in.	mm in.	mm in.	mm in.	mm in.				kg lbs.
30.391 1.1965	23.812 0.9375	-10.9 -0.43	0.8 0.03	45.5 1.79	46.5 1.83	1.5 0.06	74.8 2.94	71.0 2.80	1.8 0.07	1.1 0.05	34.6	12.1	0.0744	0.65 1.45
25.400 1.0000	20.638 0.8125	-7.4 -0.29	3.5 0.14	45.5 1.79	52.0 2.05	3.3 0.13	74.0 2.91	69.0 2.72	1.4 0.05	1.3 0.05	32.8	13.3	0.0770	0.57 1.26
25.400 1.0000	20.638 0.8125	-7.4 -0.29	1.5 0.06	45.5 1.79	48.0 1.89	0.8 0.03	74.0 2.91	71.0 2.80	1.4 0.05	1.3 0.05	32.8	13.3	0.0770	0.58 1.29
25.400 1.0000	20.638 0.8125	-7.4 -0.29	1.5 0.06	45.5 1.79	48.0 1.89	3.3 0.13	74.0 2.91	69.0 2.72	1.4 0.05	1.3 0.05	32.8	13.3	0.0770	0.57 1.27
25.400 1.0000	20.638 0.8125	-7.4 -0.29	3.5 0.14	45.5 1.79	52.0 2.05	0.8 0.03	74.0 2.91	71.0 2.80	1.4 0.05	1.3 0.05	32.8	13.3	0.0770	0.58 1.28
25.400 1.0000	24.608 0.9688	-7.4 -0.29	1.5 0.06	45.5 1.79	48.0 1.89	3.3 0.13	74.0 2.91	68.0 2.68	1.4 0.05	1.3 0.05	32.8	13.3	0.0770	0.63 1.40
30.391 1.1965	23.812 0.9375	-10.9 -0.43	3.5 0.14	45.5 1.79	52.0 2.05	0.8 0.03	74.8 2.94	72.0 2.83	1.8 0.07	1.1 0.05	34.6	12.1	0.0744	0.66 1.46
30.391 1.1965	23.812 0.9375	-10.9 -0.43	3.5 0.14	45.5 1.79	52.0 2.05	3.3 0.13	75.0 2.95	70.0 2.76	1.8 0.07	1.1 0.05	34.6	12.1	0.0744	0.65 1.44
30.391 1.1965	23.812 0.9375	-10.9 -0.43	0.8 0.03	45.5 1.79	46.5 1.83	0.8 0.03	74.8 2.94	72.0 2.83	1.8 0.07	1.1 0.05	34.6	12.1	0.0744	0.66 1.46
30.391 1.1965	23.812 0.9375	-10.9 -0.43	0.8 0.03	45.5 1.79	46.5 1.83	3.3 0.13	75.0 2.95	70.0 2.76	1.8 0.07	1.1 0.05	34.6	12.1	0.0744	0.65 1.44
30.391 1.1965	23.812 0.9375	-10.9 -0.43	0.8 0.03	45.5 1.79	46.5 1.83	3.3 0.13	76.0 2.99	72.0 2.83	1.8 0.07	1.1 0.05	34.6	12.1	0.0744	0.74 1.65
30.391 1.1965	23.812 0.9375	-10.9 -0.43	3.5 0.14	45.5 1.79	52.0 2.05	3.3 0.13	76.0 2.99	72.0 2.83	1.8 0.07	1.1 0.05	34.6	12.1	0.0744	0.74 1.64
23.698 0.9330	17.462 0.6875	2.3 0.09	2.3 0.09	50.8 2.00	56.0 2.20	1.5 0.06	84.0 3.31	75.0 2.95	3.8 0.15	2.7 0.11	22.9	8.7	0.0899	0.69 1.52
23.698 0.9330	17.462 0.6875	2.3 0.09	3.5 0.14	50.8 2.00	58.0 2.28	1.5 0.06	84.0 3.31	75.0 2.95	3.8 0.15	2.7 0.11	22.9	8.7	0.0899	0.69 1.51
41.275 1.6250	31.750 1.2500	-14.0 -0.55	0.8 0.03	52.0 2.05	53.0 2.09	3.3 0.13	110.0 4.33	105.0 4.13	3.8 0.15	1.9 0.08	75.9	16.2	0.0694	2.53 5.58
19.650 0.7736	15.507 0.6105	-3.6 -0.14	2.3 0.09	45.0 1.77	49.0 1.93	1.3 0.05	71.0 2.80	68.0 2.68	1.0 0.04	1.1 0.05	20.7	12.5	0.0709	0.37 0.81
20.940 0.8244	15.507 0.6105	-4.8 -0.19	3.5 0.14	45.0 1.77	52.0 2.05	1.3 0.05	71.0 2.80	68.0 2.68	2.3 0.09	1.1 0.05	20.7	12.5	0.0709	0.37 0.83

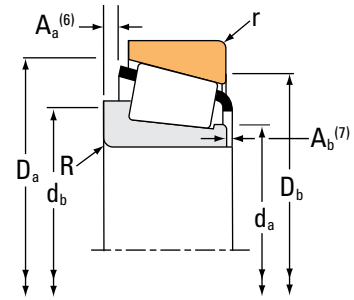
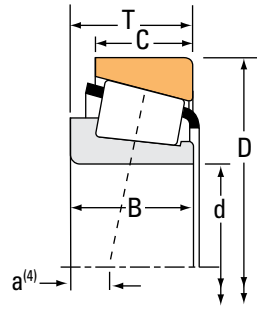
(4) Negative value indicates effective center inside cone (inner-ring) backface.  
 (5) These maximum fillet radii will be cleared by the bearing corners.  
 (6) Negative value indicates cage extends beyond cone (inner-ring) backface.  
 (7) Negative value indicates cage that does not extend beyond cone (inner-ring) front face.

Continued on next page.

# TAPERED ROLLER BEARINGS

## SINGLE-ROW • TYPE TS

### TYPE TS



Bearing Dimensions			Load Ratings							Part Number			
Bore d	O.D. D	Width T	Dynamic <sup>(1)</sup>		Factors <sup>(2)</sup>		Dynamic <sup>(3)</sup>		Factors <sup>(2)</sup>		Static C <sub>0</sub>	Inner	Outer
			C <sub>1</sub>	e	Y	C <sub>90</sub>	C <sub>a90</sub>	K	N	N			
mm in.	mm in.	mm in.	N lbf			N lbf	N lbf		N lbf				
39.980 1.5740	80.035 3.1510	20.142 0.7930	75200 16900	0.40	1.49	19500 4390	13400 3020	1.45	68900 15500		28156	28317	
39.987 1.5743	90.975 3.5817	32.000 1.2598	170000 38300	0.33	1.80	44200 9930	25200 5660	1.76	172000 38600		HM204043	HM204010	
40.000 1.5748	76.200 3.0000	20.625 0.8120	75200 16900	0.40	1.49	19500 4390	13400 3020	1.45	68900 15500		28158	28300X	
40.000 1.5748	80.000 3.1496	21.000 0.8268	94300 21200	0.27	2.20	24400 5490	11400 2570	2.14	83400 18700		344A	332	
40.000 1.5748	80.000 3.1496	21.005 0.8270	75200 16900	0.40	1.49	19500 4390	13400 3020	1.45	68900 15500		28158	28315	
40.000 1.5748	80.000 3.1496	21.006 0.8270	75200 16900	0.40	1.49	19500 4390	13400 3020	1.45	68900 15500		28158	28315A	
40.000 1.5748	84.138 3.3125	26.988 1.0625	81800 18400	0.31	1.96	21200 4770	11100 2500	1.91	88800 20000		350	3520	
40.000 1.5748	85.000 3.3465	20.638 0.8125	81800 18400	0.31	1.96	21200 4770	11100 2500	1.91	88800 20000		350	354A	
40.000 1.5748	85.000 3.3465	20.638 0.8125	81800 18400	0.31	1.96	21200 4770	11100 2500	1.91	88800 20000		350	354X	
40.000 1.5748	85.000 3.3465	20.638 0.8125	97000 21800	0.31	1.96	25100 5650	13200 2960	1.91	88800 20000		357	354A	
40.000 1.5748	85.000 3.3465	33.000 1.2992	13700 30800	0.34	1.74	35500 7990	20900 4710	1.70	160000 35900		JF4049	JF4010	
40.000 1.5748	85.725 3.3750	30.162 1.1875	124000 27900	0.40	1.49	32200 7240	22200 4980	1.45	148000 33200		3879	3820	
40.000 1.5748	87.312 3.4375	30.162 1.1875	113000 25500	0.31	1.96	29400 6610	15400 3460	1.91	134000 30100		3582	3525	
40.000 1.5748	88.500 3.4843	24.765 0.9750	99800 22400	0.78	0.77	25900 5810	34600 7770	0.75	88600 19900		44157X	44348	
40.000 1.5748	88.500 3.4843	26.988 1.0625	116000 26000	0.26	2.28	30000 6740	13500 3040	2.22	124000 28000		420	414	
40.000 1.5748	88.900 3.5000	26.988 1.0625	116000 26000	0.26	2.28	30000 6740	13500 3040	2.22	124000 28000		420	414X	
40.000 1.5748	90.000 3.5433	23.000 0.9055	81800 18400	0.31	1.96	21200 4770	11100 2500	1.91	88800 20000		350	352X	

<sup>(1)</sup>Based on 1 x 10<sup>6</sup> revolutions L<sub>10</sub> life, for the ISO life-calculation method.

<sup>(2)</sup>Consult your Timken engineer for instructions on use or review the Timken Engineering Manual on timken.com/catalogs.

<sup>(3)</sup>Based on 90 x 10<sup>6</sup> revolutions L<sub>10</sub> life, for The Timken Company life-calculation method. C<sub>90</sub> and C<sub>a90</sub> are radial and thrust values.

Bearing Dimensions											Geometry Factors			Bearing Weight
Width B	Width C	Eff. Ctr. a <sup>(4)</sup>	Shaft			Housing			Cage		G <sub>1</sub>	G <sub>2</sub>	C <sub>g</sub>	
			Max Shaft Fillet Radius R <sup>(5)</sup>	Backing Shoulder Dia. d <sub>a</sub>	Shoulder Dia. d <sub>b</sub>	Max Housing Fillet Radius r <sup>(5)</sup>	Backing Shoulder Dia. D <sub>a</sub>	Shoulder Dia. D <sub>b</sub>	A <sub>a</sub> <sup>(6)</sup>	A <sub>b</sub> <sup>(7)</sup>				
mm in.	mm in.	mm in.	mm in.	mm in.	mm in.	mm in.	mm in.	mm in.	mm in.	mm in.				kg lbs.
19.650 0.7736	15.875 0.6250	-3.6 -0.14	2.3 0.09	45.0 1.77	49.0 1.93	1.5 0.06	73.0 2.87	69.0 2.72	1.0 0.04	1.1 0.05	20.7	12.5	0.0709	0.43 0.95
32.000 1.2598	26.500 1.0433	-9.7 -0.38	1.0 0.04	53.0 2.09	54.0 2.13	3.5 0.14	86.0 3.39	79.0 3.11	1.5 0.06	1.9 0.08	47.7	14.5	0.0885	1.02 2.26
20.940 0.8244	15.494 0.6100	-4.8 -0.19	1.5 0.06	45.0 1.77	47.5 1.87	1.5 0.06	71.0 2.80	68.0 2.68	2.3 0.09	1.1 0.05	20.7	12.5	0.0709	0.38 0.85
22.403 0.8820	17.826 0.7018	-6.4 -0.25	0.8 0.03	45.5 1.79	46.0 1.81	1.3 0.05	75.0 2.95	73.0 2.87	0.7 0.02	1.1 0.05	26.5	13.0	0.0676	0.47 1.05
20.940 0.8244	15.875 0.6250	-4.8 -0.19	1.5 0.06	45.0 1.77	47.5 1.87	1.5 0.06	73.0 2.87	69.0 2.72	2.3 0.09	1.1 0.05	20.7	12.5	0.0709	0.44 0.98
20.940 0.8244	15.875 0.6250	-4.8 -0.19	1.5 0.06	45.0 1.77	47.5 1.87	2.0 0.08	73.0 2.87	69.0 2.72	2.3 0.09	1.1 0.05	20.7	12.5	0.0709	0.44 0.97
21.692 0.8540	23.812 0.9375	-4.8 -0.19	4.0 0.16	46.5 1.83	54.0 2.13	3.3 0.13	79.5 3.13	74.0 2.91	0.4 0.01	1.7 0.07	30.0	12.2	0.0732	0.61 1.35
21.692 0.8540	17.462 0.6875	-4.8 -0.19	4.0 0.16	46.5 1.83	54.0 2.13	1.3 0.05	80.0 3.15	77.0 3.03	0.4 0.01	1.7 0.07	30.0	12.2	0.0732	0.55 1.22
21.692 0.8540	17.462 0.6875	-4.8 -0.19	4.0 0.16	46.5 1.83	54.0 2.13	1.5 0.06	80.0 3.15	77.0 3.03	0.4 0.01	1.7 0.07	30.0	12.2	0.0732	0.55 1.23
21.692 0.8540	17.462 0.6875	-4.8 -0.19	2.3 0.09	46.5 1.83	51.0 2.01	1.3 0.05	80.0 3.15	77.0 3.03	0.4 0.01	1.7 0.07	30.0	12.2	0.0732	0.56 1.23
32.500 1.2795	28.000 1.1024	-10.2 -0.40	2.5 0.10	49.0 1.93	55.0 2.17	2.0 0.08	80.0 3.15	75.0 2.95	1.1 0.04	2.0 0.08	39.5	13.6	0.0841	0.90 1.99
30.162 1.1875	23.812 0.9375	-8.1 -0.32	0.8 0.03	50.0 1.97	51.0 2.01	3.3 0.13	81.0 3.19	73.0 2.87	1.4 0.05	2.2 0.09	37.8	13.5	0.0873	0.82 1.81
30.886 1.2160	23.812 0.9375	-10.2 -0.40	3.5 0.14	47.0 1.85	53.0 2.09	3.3 0.13	81.0 3.19	75.0 2.95	2.2 0.09	0.7 0.03	39.5	12.5	0.0808	0.84 1.84
23.063 0.9080	17.462 0.6875	3.0 0.12	2.3 0.09	50.8 2.00	56.0 2.20	1.5 0.06	84.0 3.31	75.0 2.95	3.3 0.13	3.0 0.12	22.9	8.7	0.0899	0.68 1.50
29.083 1.1450	22.225 0.8750	-9.7 -0.38	3.5 0.14	46.0 1.81	52.0 2.05	1.5 0.06	80.0 3.15	77.0 3.03	1.2 0.04	0.8 0.03	34.4	9.9	0.0731	0.80 1.76
29.083 1.1450	22.225 0.8750	-9.7 -0.38	3.5 0.14	46.0 1.81	52.0 2.05	0.8 0.03	80.0 3.15	77.5 3.07	1.2 0.04	0.8 0.03	34.4	9.9	0.0731	0.81 1.78
21.692 0.8540	21.808 0.8586	-4.8 -0.19	4.0 0.16	46.5 1.83	54.0 2.13	2.3 0.09	82.0 3.23	78.0 3.07	0.4 0.01	1.7 0.07	30.0	12.2	0.0732	0.70 1.56

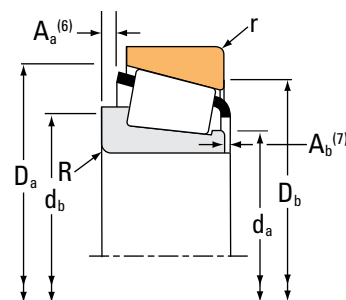
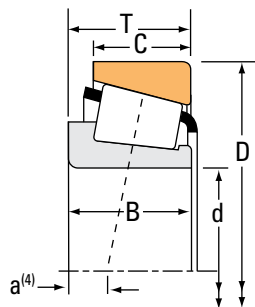
(4) Negative value indicates effective center inside cone (inner-ring) backface.  
 (5) These maximum fillet radii will be cleared by the bearing corners.  
 (6) Negative value indicates cage extends beyond cone (inner-ring) backface.  
 (7) Negative value indicates cage that does not extend beyond cone (inner-ring) front face.

Continued on next page.

# TAPERED ROLLER BEARINGS

## SINGLE-ROW • TYPE TS

### TYPE TS



Bearing Dimensions			Load Ratings							Part Number			
Bore d	O.D. D	Width T	Dynamic <sup>(1)</sup>		Factors <sup>(2)</sup>		Dynamic <sup>(3)</sup>		Factors <sup>(2)</sup>		Static C <sub>0</sub>	Inner	Outer
			C <sub>1</sub>	e	Y	C <sub>90</sub>	C <sub>a90</sub>	K	N	N			
mm in.	mm in.	mm in.	N lbf			N lbf	N lbf		N lbf				
40.000 1.5748	90.119 3.5480	23.000 0.9055	81800 18400	0.31	1.96	21200 4770	11100 2500	1.91	88800 20000			350	352
40.000 1.5748	90.119 3.5480	23.000 0.9055	97000 21800	0.31	1.96	25100 5650	13200 2960	1.91	88800 20000			350A	352
40.000 1.5748	90.119 3.5480	23.000 0.9055	97000 21800	0.31	1.96	25100 5650	13200 2960	1.91	88800 20000			357	352
40.000 1.5748	95.250 3.7500	27.783 1.0938	127000 28500	0.28	2.11	32900 7400	16000 3600	2.05	144000 32400			442-S	432
40.000 1.5748	107.950 4.2500	36.512 1.4375	172000 38700	0.30	2.02	44600 10000	22700 5090	1.97	206000 46200			543	532X
40.483 1.5938	82.550 3.2500	29.370 1.1563	103000 23100	0.55	1.10	26600 5980	24900 5590	1.07	130000 29300			HM801349	HM801310
40.987 1.6137	67.975 2.6762	17.500 0.6890	59100 13300	0.35	1.72	15300 3440	9140 2050	1.68	63500 14300			LM300849	LM300811
41.275 1.6250	67.975 2.6762	17.500 0.6890	49800 11200	0.35	1.72	12900 2900	7710 1730	1.68	63500 14300			LM300848	LM300811
41.275 1.6250	73.025 2.8750	16.667 0.6562	50800 11400	0.35	1.71	13200 2960	7890 1770	1.67	58100 13100			18590	18520
41.275 1.6250	73.431 2.8910	19.558 0.7700	74800 16800	0.40	1.50	19400 4360	13300 2980	1.46	74200 16700			LM501349	LM501310
41.275 1.6250	73.431 2.8910	19.558 0.7700	74800 16800	0.40	1.50	19400 4360	13300 2980	1.46	74200 16700			LM501349A	LM501310
41.275 1.6250	73.431 2.8910	21.430 0.8437	74800 16800	0.40	1.50	19400 4360	13300 2980	1.46	74200 16700			LM501349	LM501314
41.275 1.6250	73.431 2.8910	23.012 0.9060	74800 16800	0.40	1.50	19400 4360	13300 2980	1.46	74200 16700			LM501349	LM501311
41.275 1.6250	76.200 3.0000	18.009 0.7090	48100 10800	0.49	1.23	12500 2800	10400 2340	1.20	55100 12400			11163	11300
41.275 1.6250	76.200 3.0000	18.009 0.7090	48100 10800	0.49	1.23	12500 2800	10400 2340	1.20	55100 12400			11162	11300
41.275 1.6250	76.200 3.0000	22.225 0.8750	75500 17000	0.39	1.53	19600 4400	13200 2960	1.49	89200 20100			24780	24722
41.275 1.6250	76.200 3.0000	22.225 0.8750	75500 17000	0.39	1.53	19600 4400	13200 2960	1.49	89200 20100			24780	24720

<sup>(1)</sup>Based on 1 x 10<sup>6</sup> revolutions L<sub>10</sub> life, for the ISO life-calculation method.

<sup>(2)</sup>Consult your Timken engineer for instructions on use or review the Timken Engineering Manual on timken.com/catalogs.

<sup>(3)</sup>Based on 90 x 10<sup>6</sup> revolutions L<sub>10</sub> life, for The Timken Company life-calculation method. C<sub>90</sub> and C<sub>a90</sub> are radial and thrust values.

Bearing Dimensions											Geometry Factors			Bearing Weight
Width B	Width C	Eff. Ctr. a <sup>(4)</sup>	Shaft			Housing			Cage		G <sub>1</sub>	G <sub>2</sub>	C <sub>g</sub>	
			Max Shaft Fillet Radius R <sup>(5)</sup>	Backing Shoulder Dia. d <sub>a</sub> d <sub>b</sub>		Max Housing Fillet Radius r <sup>(5)</sup>	Backing Shoulder Dia. D <sub>a</sub> D <sub>b</sub>		A <sub>a</sub> <sup>(6)</sup>	A <sub>b</sub> <sup>(7)</sup>				
mm in.	mm in.	mm in.	mm in.	mm in.	mm in.	mm in.	mm in.	mm in.	mm in.	mm in.				kg lbs.
21.692 0.8540	21.808 0.8586	-4.8 -0.19	4.0 0.16	46.5 1.83	54.0 2.13	2.3 0.09	82.0 3.23	78.0 3.07	0.4 0.01	1.7 0.07	30.0	12.2	0.0732	0.71 1.57
21.692 0.8540	21.808 0.8586	-4.8 -0.19	0.8 0.03	46.5 1.83	47.5 1.87	2.3 0.09	82.0 3.23	78.0 3.07	0.4 0.01	1.7 0.07	30.0	12.2	0.0732	0.72 1.59
21.692 0.8540	21.808 0.8586	-4.8 -0.19	2.3 0.09	46.5 1.83	51.0 2.01	2.3 0.09	82.0 3.23	78.0 3.07	0.4 0.01	1.7 0.07	30.0	12.2	0.0732	0.72 1.58
29.900 1.1772	22.225 0.8750	-9.1 -0.36	3.5 0.14	47.0 1.85	54.0 2.13	2.3 0.09	87.0 3.43	83.0 3.27	1.6 0.06	0.5 0.02	42.5	11.3	0.0805	1.00 2.21
36.957 1.4550	28.575 1.1250	-12.2 -0.48	3.5 0.14	50.0 1.97	57.0 2.24	3.3 0.13	100.0 3.94	94.0 3.70	2.7 0.10	1.0 0.04	64.3	16.1	0.0938	1.74 3.85
28.575 1.1250	23.020 0.9063	-4.8 -0.19	3.5 0.14	49.1 1.93	58.0 2.28	3.3 0.13	78.0 3.07	68.0 2.68	2.1 0.08	1.9 0.08	33.7	14.0	0.0928	0.72 1.60
18.000 0.7087	13.500 0.5315	-3.6 -0.14	3.5 0.14	45.5 1.79	52.0 2.05	1.5 0.06	65.0 2.56	61.0 2.40	0.6 0.02	1.3 0.05	22.5	18.1	0.0698	0.24 0.53
18.000 0.7087	13.500 0.5315	-3.6 -0.14	3.5 0.14	45.5 1.79	52.0 2.05	1.5 0.06	65.0 2.56	61.0 2.40	0.6 0.02	1.3 0.05	22.5	18.1	0.0698	0.24 0.53
17.462 0.6875	12.700 0.5000	-2.8 -0.11	3.5 0.14	46.0 1.81	53.0 2.09	1.5 0.06	69.0 2.72	66.0 2.60	0.4 0.01	1.3 0.05	21.0	16.8	0.0681	0.28 0.61
19.812 0.7800	14.732 0.5800	-3.3 -0.13	3.5 0.14	48.0 1.89	54.0 2.13	0.8 0.03	70.0 2.76	67.0 2.64	0.9 0.03	1.0 0.04	23.3	13.3	0.0739	0.34 0.74
19.812 0.7800	14.732 0.5800	-3.3 -0.13	0.8 0.03	46.5 1.83	47.0 1.85	0.8 0.03	70.0 2.76	67.0 2.64	1.0 0.04	1.0 0.04	23.3	13.3	0.0739	0.33 0.73
19.812 0.7800	16.604 0.6537	-3.3 -0.13	3.5 0.14	48.0 1.89	54.0 2.13	0.8 0.03	70.0 2.76	65.0 2.56	0.9 0.03	1.0 0.04	23.3	13.3	0.0739	0.36 0.78
19.812 0.7800	18.186 0.7160	-3.3 -0.13	3.5 0.14	48.0 1.89	54.0 2.13	2.3 0.09	70.0 2.76	64.0 2.52	0.9 0.03	1.0 0.04	23.3	13.3	0.0739	0.37 0.81
17.384 0.6844	14.288 0.5625	-0.8 -0.03	0.8 0.03	46.5 1.83	47.0 1.85	1.5 0.06	71.0 2.80	67.0 2.64	* *	* *	19.2	16.0	0.0735	0.34 0.74
17.384 0.6844	14.288 0.5625	-0.8 -0.03	1.5 0.06	46.5 1.83	49.0 1.93	1.5 0.06	71.0 2.80	67.0 2.64	1.6 0.06	1.6 0.06	19.2	16.0	0.0735	0.34 0.74
23.020 0.9063	17.462 0.6875	-4.8 -0.19	3.5 0.14	47.0 1.85	54.0 2.13	3.3 0.13	72.0 2.83	66.0 2.60	1.1 0.04	1.1 0.05	26.4	16.5	0.0767	0.42 0.92
23.020 0.9063	17.462 0.6875	-4.8 -0.19	3.5 0.14	47.0 1.85	54.0 2.13	0.8 0.03	72.0 2.83	68.0 2.68	1.1 0.04	1.1 0.05	26.4	16.5	0.0767	0.43 0.94

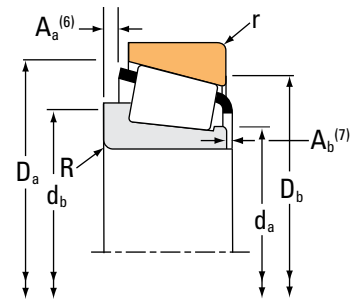
(4) Negative value indicates effective center inside cone (inner-ring) backface.  
 (5) These maximum fillet radii will be cleared by the bearing corners.  
 (6) Negative value indicates cage extends beyond cone (inner-ring) backface.  
 (7) Negative value indicates cage that does not extend beyond cone (inner-ring) front face.  
 (\*) Contact your Timken engineer for details.

Continued on next page.

# TAPERED ROLLER BEARINGS

## SINGLE-ROW • TYPE TS

### TYPE TS



Bearing Dimensions			Load Ratings							Part Number			
Bore d	O.D. D	Width T	Dynamic <sup>(1)</sup>		Factors <sup>(2)</sup>		Dynamic <sup>(3)</sup>		Factors <sup>(2)</sup>		Static C <sub>0</sub>	Inner	Outer
			C <sub>1</sub>	e	Y	C <sub>90</sub>	C <sub>a90</sub>	K	N	N			
mm in.	mm in.	mm in.	N lbf			N lbf	N lbf		N lbf				
41.275 1.6250	76.200 3.0000	22.225 0.8750	75500 17000	0.39	1.53	19600 4400	13200 2960	1.49	89200 20100		24781	24720	
41.275 1.6250	76.200 3.0000	25.400 1.0000	75500 17000	0.39	1.53	19600 4400	13200 2960	1.49	89200 20100		24780	24721	
41.275 1.6250	76.200 3.0000	25.400 1.0000	75500 17000	0.39	1.53	19600 4400	13200 2960	1.49	89200 20100		24781	24721	
41.275 1.6250	79.375 3.1250	23.812 0.9375	91100 20500	0.32	1.88	23600 5310	12900 2900	1.83	110000 24800		26882	26822	
41.275 1.6250	79.375 3.1250	23.812 0.9375	91100 20500	0.32	1.88	23600 5310	12900 2900	1.83	110000 24800		26885	26822	
41.275 1.6250	80.000 3.1496	18.009 0.7090	48100 10800	0.49	1.23	12500 2800	10400 2340	1.20	55100 12400		11162	11315	
41.275 1.6250	80.000 3.1496	21.000 0.8268	94300 21200	0.27	2.20	24400 5490	11400 2570	2.14	83400 18700		342	332	
41.275 1.6250	80.000 3.1496	21.000 0.8268	94300 21200	0.27	2.20	24400 5490	11400 2570	2.14	83400 18700		336	332	
41.275 1.6250	80.035 3.1510	29.370 1.1563	115000 25800	0.27	2.20	29800 6700	13900 3130	2.14	129000 29100		3383	3339	
41.275 1.6250	80.167 3.1562	25.400 1.0000	91100 20500	0.32	1.88	23600 5310	12900 2900	1.83	110000 24800		26882	26820	
41.275 1.6250	80.167 3.1562	26.988 1.0625	94300 21200	0.27	2.20	24400 5490	11400 2570	2.14	83400 18700		336	3320	
41.275 1.6250	80.167 3.1562	26.988 1.0625	94300 21200	0.27	2.20	24400 5490	11400 2570	2.14	83400 18700		342	3320	
41.275 1.6250	80.167 3.1562	29.370 1.1563	91100 20500	0.32	1.88	23600 5310	12900 2900	1.83	110000 24800		26882	26821	
41.275 1.6250	81.755 3.2187	29.370 1.1563	115000 25800	0.27	2.20	29800 6700	13900 3130	2.14	129000 29100		3383	3329	
41.275 1.6250	82.550 3.2500	26.195 1.0313	92900 20900	0.40	1.49	24100 5420	16600 3730	1.45	115000 25800		22778	22721	
41.275 1.6250	82.550 3.2500	26.543 1.0450	91700 20600	0.55	1.10	23800 5340	22200 4990	1.07	112000 25300		M802048	M802011	
41.275 1.6250	82.550 3.2500	26.543 1.0450	91700 20600	0.55	1.10	23800 5340	22200 4990	1.07	112000 25300		M802047	M802011	

<sup>(1)</sup>Based on 1 x 10<sup>6</sup> revolutions L<sub>10</sub> life, for the ISO life-calculation method.

<sup>(2)</sup>Consult your Timken engineer for instructions on use or review the Timken Engineering Manual on timken.com/catalogs.

<sup>(3)</sup>Based on 90 x 10<sup>6</sup> revolutions L<sub>10</sub> life, for The Timken Company life-calculation method. C<sub>90</sub> and C<sub>a90</sub> are radial and thrust values.



Bearing Dimensions											Geometry Factors			Bearing Weight
Width B	Width C	Eff. Ctr. a <sup>(4)</sup>	Shaft			Housing			Cage		G <sub>1</sub>	G <sub>2</sub>	C <sub>g</sub>	
			Max Shaft Fillet Radius R <sup>(5)</sup>	Backing Shoulder Dia. d <sub>a</sub>	Backing Shoulder Dia. d <sub>b</sub>	Max Housing Fillet Radius r <sup>(5)</sup>	Backing Shoulder Dia. D <sub>a</sub>	Backing Shoulder Dia. D <sub>b</sub>	A <sub>a</sub> <sup>(6)</sup>	A <sub>b</sub> <sup>(7)</sup>				
mm in.	mm in.	mm in.	mm in.	mm in.	mm in.	mm in.	mm in.	mm in.	mm in.	mm in.				kg lbs.
23.020 0.9063	17.462 0.6875	-4.8 -0.19	0.8 0.03	47.0 1.85	48.0 1.89	0.8 0.03	72.0 2.83	68.0 2.68	1.2 0.04	1.1 0.05	26.4	16.5	0.0767	0.43 0.95
23.020 0.9063	20.638 0.8125	-4.8 -0.19	3.5 0.14	47.0 1.85	54.0 2.13	2.3 0.09	72.0 2.83	66.0 2.60	1.1 0.04	1.1 0.05	26.4	16.5	0.0767	0.47 1.02
23.020 0.9063	20.638 0.8125	-4.8 -0.19	0.8 0.03	47.0 1.85	48.0 1.89	2.3 0.09	72.0 2.83	66.0 2.60	1.2 0.04	1.1 0.05	26.4	16.5	0.0767	0.47 1.03
25.400 1.0000	19.050 0.7500	-7.4 -0.29	3.5 0.14	47.0 1.85	54.0 2.13	0.8 0.03	74.0 2.91	71.0 2.80	1.4 0.05	1.3 0.05	32.8	13.3	0.0770	0.52 1.15
25.400 1.0000	19.050 0.7500	-7.4 -0.29	0.8 0.03	47.0 1.85	48.0 1.89	0.8 0.03	74.0 2.91	71.0 2.80	1.4 0.05	1.3 0.05	32.8	13.3	0.0770	0.52 1.17
17.384 0.6844	14.288 0.5625	-0.8 -0.03	1.5 0.06	46.5 1.83	49.0 1.93	1.5 0.06	73.0 2.87	69.0 2.72	1.6 0.06	1.6 0.06	19.2	16.0	0.0735	0.39 0.85
22.403 0.8820	17.826 0.7018	-6.4 -0.25	3.5 0.14	46.0 1.81	53.0 2.09	1.3 0.05	75.0 2.95	73.0 2.87	0.7 0.02	1.1 0.05	26.5	13.0	0.0676	0.45 1.01
22.403 0.8820	17.826 0.7018	-6.4 -0.25	0.8 0.03	46.0 1.81	47.0 1.85	1.3 0.05	75.0 2.95	73.0 2.87	0.7 0.02	1.1 0.05	26.5	13.0	0.0676	0.46 1.02
30.391 1.1965	23.812 0.9375	-10.9 -0.43	3.5 0.14	47.0 1.85	54.0 2.13	1.5 0.06	74.8 2.94	71.0 2.80	1.8 0.07	1.1 0.05	34.6	12.1	0.0744	0.62 1.39
25.400 1.0000	20.638 0.8125	-7.4 -0.29	3.5 0.14	47.0 1.85	54.0 2.13	3.3 0.13	74.0 2.91	69.0 2.72	1.4 0.05	1.3 0.05	32.8	13.3	0.0770	0.55 1.21
22.403 0.8820	23.812 0.9375	-6.4 -0.25	0.8 0.03	46.0 1.81	47.0 1.85	3.3 0.13	75.0 2.95	70.0 2.76	0.7 0.02	1.1 0.05	26.5	13.0	0.0676	0.53 1.17
22.403 0.8820	23.812 0.9375	-6.4 -0.25	3.5 0.14	46.0 1.81	53.0 2.09	3.3 0.13	75.0 2.95	70.0 2.76	0.7 0.02	1.1 0.05	26.5	13.0	0.0676	0.52 1.15
25.400 1.0000	24.608 0.9688	-7.4 -0.29	3.5 0.14	47.0 1.85	54.0 2.13	3.3 0.13	74.0 2.91	68.0 2.68	1.4 0.05	1.3 0.05	32.8	13.3	0.0770	0.61 1.35
30.391 1.1965	23.812 0.9375	-10.9 -0.43	3.5 0.14	47.0 1.85	54.0 2.13	3.3 0.13	75.0 2.95	71.0 2.80	1.8 0.07	1.1 0.05	34.6	12.1	0.0744	0.66 1.46
26.988 1.0625	20.638 0.8125	-6.4 -0.25	3.5 0.14	49.0 1.93	55.0 2.17	0.8 0.03	77.0 3.03	73.0 2.87	1.8 0.07	1.1 0.05	33.9	15.3	0.0841	0.64 1.40
25.654 1.0100	20.193 0.7950	-3.0 -0.12	3.5 0.14	50.6 1.99	57.0 2.24	3.3 0.13	79.0 3.11	70.0 2.76	2.2 0.09	1.7 0.07	30.9	11.9	0.0899	0.62 1.37
25.654 1.0100	20.193 0.7950	-3.0 -0.12	0.8 0.03	50.6 1.99	52.0 2.05	3.3 0.13	79.0 3.11	70.0 2.76	2.2 0.09	1.7 0.07	30.9	11.9	0.0899	0.63 1.39

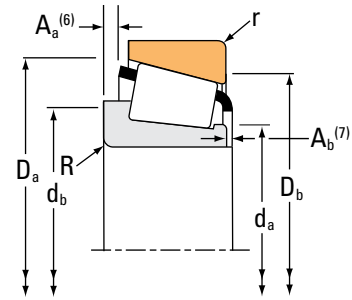
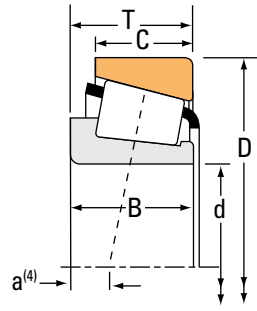
(4) Negative value indicates effective center inside cone (inner-ring) backface.  
 (5) These maximum fillet radii will be cleared by the bearing corners.  
 (6) Negative value indicates cage extends beyond cone (inner-ring) backface.  
 (7) Negative value indicates cage that does not extend beyond cone (inner-ring) front face.

Continued on next page.

# TAPERED ROLLER BEARINGS

## SINGLE-ROW • TYPE TS

### TYPE TS



Bearing Dimensions			Load Ratings							Part Number			
Bore d	O.D. D	Width T	Dynamic <sup>(1)</sup>		Factors <sup>(2)</sup>		Dynamic <sup>(3)</sup>		Factors <sup>(2)</sup>		Static C <sub>0</sub>	Inner	Outer
			C <sub>1</sub>	e	Y	C <sub>90</sub>	C <sub>a90</sub>	K	N	N			
mm in.	mm in.	mm in.	N lbf			N lbf	N lbf		N lbf				
41.275 1.6250	84.138 3.3125	29.370 1.1563	115000 25800	0.27	2.20	29800 6700	13900 3130	2.14	129000 29100			3383	3328
41.275 1.6250	84.138 3.3125	30.162 1.1875	113000 25500	0.31	1.96	29400 6610	15400 3460	1.91	134000 30100			3576	3520
41.275 1.6250	84.138 3.3125	30.162 1.1875	113000 25500	0.31	1.96	29400 6610	15400 3460	1.91	134000 30100			3576	3530
41.275 1.6250	84.138 3.3125	30.162 1.1875	113000 25500	0.31	1.96	29400 6610	15400 3460	1.91	134000 30100			3577	3530
41.275 1.6250	85.725 3.3750	30.162 1.1875	124000 27900	0.40	1.49	32200 7240	22200 4980	1.45	148000 33200			3877	3820
41.275 1.6250	85.725 3.3750	30.162 1.1875	124000 27900	0.40	1.49	32200 7240	22200 4980	1.45	148000 33200			3880	3820
41.275 1.6250	85.725 3.3750	30.162 1.1875	124000 27900	0.40	1.49	32200 7240	22200 4980	1.45	148000 33200			3880	3821
41.275 1.6250	85.725 3.3750	30.162 1.1875	124000 27900	0.40	1.49	32200 7240	22200 4980	1.45	148000 33200			3877	3821
41.275 1.6250	85.725 3.3750	30.162 1.1875	124000 27900	0.40	1.49	32200 7240	22200 4980	1.45	148000 33200			3877A	3820
41.275 1.6250	87.312 3.4375	30.162 1.1875	113000 25500	0.31	1.96	29400 6610	15400 3460	1.91	134000 30100			3577	3525
41.275 1.6250	87.312 3.4375	30.162 1.1875	113000 25500	0.31	1.96	29400 6610	15400 3460	1.91	134000 30100			3576	3525
41.275 1.6250	87.312 3.4375	30.162 1.1875	113000 25500	0.31	1.96	29400 6610	15400 3460	1.91	134000 30100			3585	3525
41.275 1.6250	88.500 3.4843	25.400 1.0000	99800 22400	0.78	0.77	25900 5810	34600 7770	0.75	88600 19900			44162	44348
41.275 1.6250	88.500 3.4843	26.988 1.0625	116000 26000	0.26	2.28	30000 6740	13500 3040	2.22	124000 28000			419	414
41.275 1.6250	88.900 3.5000	20.638 0.8125	102000 22900	0.32	1.88	26400 5930	14400 3250	1.83	95800 21500			365A	362A
41.275 1.6250	88.900 3.5000	30.162 1.1875	114000 25600	0.55	1.10	29500 6630	27600 6200	1.07	144000 32400			HM803146	HM803110
41.275 1.6250	88.900 3.5000	30.162 1.1875	114000 25600	0.55	1.10	29500 6630	27600 6200	1.07	144000 32400			HM803145	HM803110

<sup>(1)</sup>Based on 1 x 10<sup>6</sup> revolutions L<sub>10</sub> life, for the ISO life-calculation method.

<sup>(2)</sup>Consult your Timken engineer for instructions on use or review the Timken Engineering Manual on timken.com/catalogs.

<sup>(3)</sup>Based on 90 x 10<sup>6</sup> revolutions L<sub>10</sub> life, for The Timken Company life-calculation method. C<sub>90</sub> and C<sub>a90</sub> are radial and thrust values.

Bearing Dimensions											Geometry Factors			Bearing Weight
Width B	Width C	Eff. Ctr. a <sup>(4)</sup>	Shaft			Housing			Cage		G <sub>1</sub>	G <sub>2</sub>	C <sub>g</sub>	
			Max Shaft Fillet Radius R <sup>(5)</sup>	Backing Shoulder Dia. d <sub>a</sub>	mm in.	Max Housing Fillet Radius r <sup>(5)</sup>	Backing Shoulder Dia. D <sub>a</sub>	mm in.	A <sub>a</sub> <sup>(6)</sup>	A <sub>b</sub> <sup>(7)</sup>				
mm in.	mm in.	mm in.	mm in.	mm in.	mm in.	mm in.	mm in.	mm in.	mm in.	mm in.				kg lbs.
<b>30.391</b> 1.1965	<b>23.812</b> 0.9375	<b>-10.9</b> -0.43	<b>3.5</b> 0.14	<b>47.0</b> 1.85	<b>54.0</b> 2.13	<b>3.3</b> 0.13	<b>76.0</b> 2.99	<b>72.0</b> 2.83	<b>1.8</b> 0.07	<b>1.1</b> 0.05	34.6	12.1	0.0744	<b>0.71</b> 1.58
<b>30.886</b> 1.2160	<b>23.812</b> 0.9375	<b>-10.2</b> -0.40	<b>0.8</b> 0.03	<b>48.0</b> 1.89	<b>49.0</b> 1.93	<b>3.3</b> 0.13	<b>79.5</b> 3.13	<b>74.0</b> 2.91	<b>2.2</b> 0.09	<b>0.7</b> 0.03	39.5	12.5	0.0808	<b>0.75</b> 1.64
<b>30.886</b> 1.2160	<b>23.812</b> 0.9375	<b>-10.2</b> -0.40	<b>0.8</b> 0.03	<b>48.0</b> 1.89	<b>49.0</b> 1.93	<b>0.8</b> 0.03	<b>79.5</b> 3.13	<b>76.0</b> 2.99	<b>2.2</b> 0.09	<b>0.7</b> 0.03	39.5	12.5	0.0808	<b>0.76</b> 1.66
<b>30.886</b> 1.2160	<b>23.812</b> 0.9375	<b>-10.2</b> -0.40	<b>3.5</b> 0.14	<b>48.0</b> 1.89	<b>54.0</b> 2.13	<b>0.8</b> 0.03	<b>79.5</b> 3.13	<b>76.0</b> 2.99	<b>2.2</b> 0.09	<b>0.7</b> 0.03	39.5	12.5	0.0808	<b>0.75</b> 1.65
<b>30.162</b> 1.1875	<b>23.812</b> 0.9375	<b>-8.1</b> -0.32	<b>3.5</b> 0.14	<b>50.0</b> 1.98	<b>57.0</b> 2.24	<b>3.3</b> 0.13	<b>81.0</b> 3.19	<b>73.0</b> 2.87	<b>1.4</b> 0.05	<b>2.2</b> 0.09	37.8	13.5	0.0873	<b>0.80</b> 1.76
<b>30.162</b> 1.1875	<b>23.812</b> 0.9375	<b>-8.1</b> -0.32	<b>0.8</b> 0.03	<b>50.0</b> 1.98	<b>52.0</b> 2.05	<b>3.3</b> 0.13	<b>81.0</b> 3.19	<b>73.0</b> 2.87	<b>1.4</b> 0.05	<b>2.2</b> 0.09	37.8	13.5	0.0873	<b>0.80</b> 1.77
<b>30.162</b> 1.1875	<b>23.812</b> 0.9375	<b>-8.1</b> -0.32	<b>0.8</b> 0.03	<b>50.0</b> 1.98	<b>52.0</b> 2.05	<b>1.3</b> 0.05	<b>81.0</b> 3.19	<b>75.0</b> 2.95	<b>1.4</b> 0.05	<b>2.2</b> 0.09	37.8	13.5	0.0873	<b>0.81</b> 1.79
<b>30.162</b> 1.1875	<b>23.812</b> 0.9375	<b>-8.1</b> -0.32	<b>3.5</b> 0.14	<b>50.0</b> 1.98	<b>57.0</b> 2.24	<b>1.3</b> 0.05	<b>81.0</b> 3.19	<b>75.0</b> 2.95	<b>1.4</b> 0.05	<b>2.2</b> 0.09	37.8	13.5	0.0873	<b>0.81</b> 1.78
<b>30.162</b> 1.1875	<b>23.812</b> 0.9375	<b>-8.1</b> -0.32	<b>2.3</b> 0.09	<b>50.0</b> 1.98	<b>55.0</b> 2.17	<b>3.3</b> 0.13	<b>81.0</b> 3.19	<b>73.0</b> 2.87	<b>1.4</b> 0.05	<b>2.2</b> 0.09	37.8	13.5	0.0873	<b>0.80</b> 1.76
<b>30.886</b> 1.2160	<b>23.812</b> 0.9375	<b>-10.2</b> -0.40	<b>3.5</b> 0.14	<b>48.0</b> 1.89	<b>54.0</b> 2.13	<b>3.3</b> 0.13	<b>81.0</b> 3.19	<b>75.0</b> 2.95	<b>2.2</b> 0.09	<b>0.7</b> 0.03	39.5	12.5	0.0808	<b>0.82</b> 1.80
<b>30.886</b> 1.2160	<b>23.812</b> 0.9375	<b>-10.2</b> -0.40	<b>0.8</b> 0.03	<b>48.0</b> 1.89	<b>49.0</b> 1.93	<b>3.3</b> 0.13	<b>81.0</b> 3.19	<b>75.0</b> 2.95	<b>2.2</b> 0.09	<b>0.7</b> 0.03	39.5	12.5	0.0808	<b>0.83</b> 1.81
<b>30.886</b> 1.2160	<b>23.812</b> 0.9375	<b>-10.2</b> -0.40	<b>1.5</b> 0.06	<b>48.0</b> 1.89	<b>50.0</b> 1.97	<b>3.3</b> 0.13	<b>81.0</b> 3.19	<b>75.0</b> 2.95	<b>2.2</b> 0.09	<b>0.7</b> 0.03	39.5	12.5	0.0808	<b>0.83</b> 1.81
<b>23.698</b> 0.9330	<b>17.462</b> 0.6875	<b>2.3</b> 0.09	<b>2.3</b> 0.09	<b>50.8</b> 2.00	<b>57.0</b> 2.24	<b>1.5</b> 0.06	<b>84.0</b> 3.31	<b>75.0</b> 2.95	<b>3.8</b> 0.15	<b>2.7</b> 0.11	22.9	8.7	0.0899	<b>0.67</b> 1.48
<b>29.083</b> 1.1450	<b>22.225</b> 0.8750	<b>-9.7</b> -0.38	<b>3.5</b> 0.14	<b>47.0</b> 1.85	<b>54.0</b> 2.13	<b>1.5</b> 0.06	<b>80.0</b> 3.15	<b>77.0</b> 3.03	<b>1.2</b> 0.04	<b>0.8</b> 0.03	34.4	9.9	0.0731	<b>0.78</b> 1.71
<b>22.225</b> 0.8750	<b>16.513</b> 0.6501	<b>-4.3</b> -0.17	<b>3.5</b> 0.14	<b>48.5</b> 1.91	<b>55.0</b> 2.17	<b>1.3</b> 0.05	<b>84.0</b> 3.31	<b>81.0</b> 3.19	<b>0.4</b> 0.01	<b>1.1</b> 0.04	33.8	14.0	0.0773	<b>0.63</b> 1.38
<b>29.370</b> 1.1563	<b>23.020</b> 0.9063	<b>-4.3</b> -0.17	<b>3.5</b> 0.14	<b>53.0</b> 2.09	<b>60.0</b> 2.36	<b>3.3</b> 0.13	<b>85.0</b> 3.35	<b>74.0</b> 2.91	<b>1.5</b> 0.05	<b>2.2</b> 0.09	39.2	10.6	0.0974	<b>0.89</b> 1.96
<b>29.370</b> 1.1563	<b>23.020</b> 0.9063	<b>-4.3</b> -0.17	<b>0.8</b> 0.03	<b>53.0</b> 2.09	<b>54.0</b> 2.13	<b>3.3</b> 0.13	<b>85.0</b> 3.35	<b>74.0</b> 2.91	<b>1.5</b> 0.05	<b>2.2</b> 0.09	39.2	10.6	0.0974	<b>0.89</b> 1.98

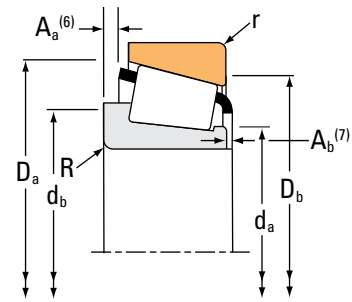
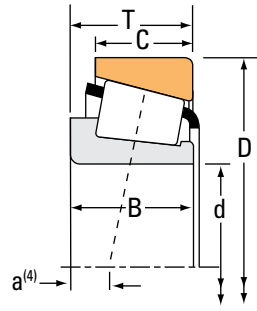
<sup>(4)</sup>Negative value indicates effective center inside cone (inner-ring) backface.  
<sup>(5)</sup>These maximum fillet radii will be cleared by the bearing corners.  
<sup>(6)</sup>Negative value indicates cage extends beyond cone (inner-ring) backface.  
<sup>(7)</sup>Negative value indicates cage that does not extend beyond cone (inner-ring) front face.

Continued on next page.

# TAPERED ROLLER BEARINGS

## SINGLE-ROW • TYPE TS

### TYPE TS



Bearing Dimensions			Load Ratings						Part Number				
Bore d	O.D. D	Width T	Dynamic <sup>(1)</sup>		Factors <sup>(2)</sup>		Dynamic <sup>(3)</sup>		Factors <sup>(2)</sup>		Static C <sub>0</sub>	Inner	Outer
			C <sub>1</sub>	e	Y	C <sub>90</sub>	C <sub>a90</sub>	K	N	N			
mm in.	mm in.	mm in.	N lbf			N lbf	N lbf		N lbf				
41.275 1.6250	90.000 3.5433	19.914 0.7874	102000 22900	0.32	1.88	26400 5930	14400 3250	1.83	95800 21500		365A	362	
41.275 1.6250	90.488 3.5625	39.688 1.5625	199000 44700	0.28	2.11	51500 11600	25100 5640	2.05	204000 45900		4388	4335	
41.275 1.6250	92.075 3.6250	26.195 1.0313	101000 22800	0.83	0.72	26300 5910	37400 8410	0.70	92500 20800		M903345	M903310	
41.275 1.6250	92.075 3.6250	30.162 1.1875	114000 25600	0.55	1.10	29500 6630	27600 6200	1.07	144000 32400		HM803146	HM803112	
41.275 1.6250	92.075 3.6250	30.162 1.1875	114000 25600	0.55	1.10	29500 6630	27600 6200	1.07	144000 32400		HM803145	HM803112	
41.275 1.6250	93.662 3.6875	31.750 1.2500	136000 30500	0.36	1.67	35200 7900	21700 4870	1.62	156000 35000		49162	49368	
41.275 1.6250	95.250 3.7500	27.783 1.0938	127000 28500	0.28	2.11	32900 7400	16000 3600	2.05	144000 32400		447	432	
41.275 1.6250	95.250 3.7500	30.162 1.1875	147000 33100	0.55	1.10	38200 8590	35700 8030	1.07	157000 35400		HM804840	HM804810	
41.275 1.6250	95.250 3.7500	30.958 1.2188	119000 26700	0.74	0.81	30800 6920	39000 8760	0.79	104000 23400		53162	53375	
41.275 1.6250	95.250 3.7500	30.958 1.2188	136000 30700	0.74	0.81	35400 7950	44800 10100	0.79	132000 29700		HM903245	HM903210	
41.275 1.6250	95.250 3.7500	30.958 1.2188	136000 30700	0.74	0.81	35400 7950	44800 10100	0.79	132000 29700		HM903244	HM903210	
41.275 1.6250	95.250 3.7500	31.753 1.2501	127000 28500	0.28	2.11	32900 7400	16000 3600	2.05	144000 32400		447	432X	
41.275 1.6250	98.425 3.8750	30.958 1.2188	119000 26700	0.74	0.81	30800 6920	39000 8760	0.79	104000 23400		53162	53387	
41.275 1.6250	98.425 3.8750	30.958 1.2188	136000 30700	0.74	0.81	35400 7950	44800 10100	0.79	132000 29700		HM903244	HM903216	
41.275 1.6250	101.600 4.0000	34.925 1.3750	165000 37000	0.29	2.10	42700 9600	20800 4690	2.05	191000 43000		526	522	
41.275 1.6250	104.775 4.1250	36.512 1.4375	172000 38600	0.49	1.23	44500 10000	37100 8350	1.20	223000 50200		HM807035	HM807010	
41.275 1.6250	107.950 4.2500	27.783 1.0938	136000 30500	0.34	1.79	35200 7900	20200 4540	1.74	166000 37200		464A	453A	

<sup>(1)</sup>Based on 1 x 10<sup>6</sup> revolutions L<sub>10</sub> life, for the ISO life-calculation method.

<sup>(2)</sup>Consult your Timken engineer for instructions on use or review the Timken Engineering Manual on timken.com/catalogs.

<sup>(3)</sup>Based on 90 x 10<sup>6</sup> revolutions L<sub>10</sub> life, for The Timken Company life-calculation method. C<sub>90</sub> and C<sub>a90</sub> are radial and thrust values.

Bearing Dimensions											Geometry Factors			Bearing Weight
Width B	Width C	Eff. Ctr. a <sup>(4)</sup>	Shaft			Housing			Cage		G <sub>1</sub>	G <sub>2</sub>	C <sub>g</sub>	
			Max Shaft Fillet Radius R <sup>(5)</sup>	Backing Shoulder Dia. d <sub>a</sub>	mm in.	Max Housing Fillet Radius r <sup>(5)</sup>	Backing Shoulder Dia. D <sub>a</sub>	mm in.	A <sub>a</sub> <sup>(6)</sup>	A <sub>b</sub> <sup>(7)</sup>				
mm in.	mm in.	mm in.	mm in.	mm in.	mm in.	mm in.	mm in.	mm in.	mm in.	mm in.			kg lbs.	
22.225 0.8750	15.875 0.6250	-4.3 -0.17	3.5 0.14	48.5 1.91	55.0 2.17	2.0 0.08	84.0 3.31	81.0 3.19	0.4 0.01	1.1 0.04	33.8	14.0	0.0773	0.63 1.40
40.386 1.5900	33.338 1.3125	-15.0 -0.59	3.5 0.14	52.0 2.05	60.0 2.36	3.3 0.13	85.0 3.35	77.0 3.03	2.2 0.09	0.6 0.03	52.9	14.3	0.0872	1.24 2.74
23.812 0.9375	16.670 0.6563	3.6 0.14	3.5 0.14	54.0 2.13	65.0 2.56	1.5 0.06	88.0 3.46	78.0 3.07	4.8 0.19	3.4 0.14	25.6	13.1	0.0948	0.76 1.68
29.370 1.1563	23.020 0.9063	-4.3 -0.17	3.5 0.14	53.0 2.09	60.0 2.36	3.3 0.13	86.0 3.39	76.0 2.99	1.5 0.05	2.2 0.09	39.2	10.6	0.0974	0.97 2.14
29.370 1.1563	23.020 0.9063	-4.3 -0.17	0.8 0.03	53.0 2.09	54.0 2.13	3.3 0.13	86.0 3.39	76.0 2.99	1.5 0.05	2.2 0.09	39.2	10.6	0.0974	0.97 2.15
31.750 1.2500	25.400 1.0000	-9.1 -0.36	3.5 0.14	50.0 1.97	57.0 2.24	3.3 0.13	87.0 3.43	82.0 3.23	2.9 0.11	0.8 0.04	42.4	13.6	0.0872	1.03 2.27
29.900 1.1772	22.225 0.8750	-9.1 -0.36	3.5 0.14	48.5 1.91	55.0 2.17	2.3 0.09	87.0 3.43	83.0 3.27	1.6 0.06	0.5 0.02	42.5	11.3	0.0805	0.98 2.17
29.370 1.1563	23.020 0.9063	-3.8 -0.15	3.5 0.14	54.0 2.13	61.0 2.40	3.3 0.13	91.0 3.58	81.0 3.19	2.2 0.09	2.8 0.11	44.8	13.8	0.1017	1.07 2.36
28.300 1.1142	20.638 0.8125	-0.3 -0.01	1.5 0.06	52.7 2.07	57.0 2.24	0.8 0.03	89.0 3.50	81.0 3.19	5.7 0.22	2.2 0.09	26.7	9.6	0.0930	0.97 2.15
28.575 1.1250	22.225 0.8750	0.5 0.02	3.5 0.14	54.0 2.13	63.0 2.48	0.8 0.03	91.0 3.58	81.0 3.19	3.9 0.15	2.1 0.08	33.7	12.4	0.1010	1.04 2.30
28.300 1.1142	22.225 0.8750	0.5 0.02	1.5 0.06	54.0 2.13	59.0 2.32	0.8 0.03	91.0 3.58	81.0 3.19	3.9 0.15	2.3 0.09	33.7	12.4	0.1010	1.04 2.30
29.900 1.1772	26.195 1.0313	-9.1 -0.36	3.5 0.14	48.5 1.91	55.0 2.17	3.3 0.13	87.0 3.43	81.0 3.19	1.6 0.06	0.5 0.02	42.5	11.3	0.0805	1.06 2.35
28.300 1.1142	20.638 0.8125	-0.3 -0.01	1.5 0.06	52.7 2.07	57.0 2.24	0.8 0.03	91.0 3.58	82.0 3.23	5.7 0.22	2.2 0.09	26.7	9.6	0.0930	1.05 2.33
28.300 1.1142	22.225 0.8750	0.5 0.02	1.5 0.06	54.0 2.13	59.0 2.32	0.8 0.03	92.0 3.62	82.0 3.23	3.9 0.15	2.3 0.09	33.7	12.4	0.1010	1.13 2.48
36.068 1.4200	26.988 1.0625	-12.7 -0.50	3.5 0.14	50.0 1.97	57.0 2.24	3.3 0.13	95.0 3.74	89.0 3.50	2.7 0.10	1.8 0.07	57.9	13.4	0.0894	1.42 3.14
36.512 1.4375	28.575 1.1250	-7.4 -0.29	1.5 0.06	57.0 2.24	60.0 2.36	3.3 0.13	100.0 3.94	89.0 3.50	3.4 0.13	2.0 0.08	63.9	17.1	0.0760	1.66 3.66
29.317 1.1542	22.225 0.8750	-7.1 -0.28	1.5 0.06	52.0 2.05	54.0 2.13	0.8 0.03	100.0 3.94	97.0 3.82	2.1 0.08	1.4 0.06	58.6	17.1	0.0946	1.39 3.05

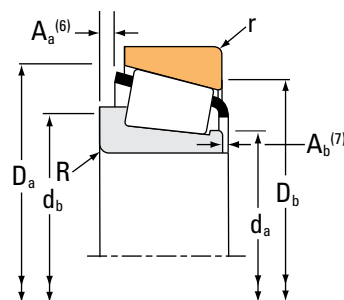
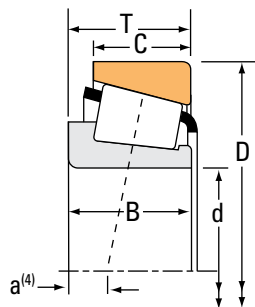
(4) Negative value indicates effective center inside cone (inner-ring) backface.  
 (5) These maximum fillet radii will be cleared by the bearing corners.  
 (6) Negative value indicates cage extends beyond cone (inner-ring) backface.  
 (7) Negative value indicates cage that does not extend beyond cone (inner-ring) front face.

Continued on next page.

# TAPERED ROLLER BEARINGS

## SINGLE-ROW • TYPE TS

### TYPE TS



Bearing Dimensions			Load Ratings							Part Number			
Bore d	O.D. D	Width T	Dynamic <sup>(1)</sup>		Factors <sup>(2)</sup>		Dynamic <sup>(3)</sup>		Factors <sup>(2)</sup>		Static C <sub>0</sub>	Inner	Outer
			C <sub>1</sub>	e	Y	C <sub>90</sub>	C <sub>a90</sub>	K	N	N			
mm in.	mm in.	mm in.	N lbf			N lbf	N lbf		N lbf				
41.275 1.6250	107.950 4.2500	27.783 1.0938	136000 30500	0.34	1.79	35200 7900	20200 4540	1.74	166000 37200		464	453A	
41.275 1.6250	107.950 4.2500	36.512 1.4375	172000 38700	0.30	2.02	44600 10000	22700 5090	1.97	206000 46200		541	532X	
42.000 1.6535	80.000 3.1496	18.009 0.7090	48100 10800	0.49	1.23	12500 2800	10400 2340	1.20	55100 12400		11165X	11315	
42.850 1.6870	104.775 4.1250	30.162 1.1875	136000 30500	0.34	1.79	35200 7900	20200 4540	1.74	166000 37200		461	453X	
42.850 1.6870	107.950 4.2500	27.795 1.0943	136000 30500	0.34	1.79	35200 7900	20200 4540	1.74	166000 37200		461	453	
42.850 1.6870	110.000 4.3307	27.795 1.0943	136000 30500	0.34	1.79	35200 7900	20200 4540	1.74	166000 37200		461	454	
42.862 1.6875	76.992 3.0312	17.462 0.6875	49500 11100	0.51	1.19	12800 2890	11100 2500	1.15	58100 13100		12168	12303	
42.862 1.6875	82.550 3.2500	19.842 0.7812	77400 17400	0.43	1.39	20100 4510	14800 3320	1.36	73200 16500		22168	22325	
42.862 1.6875	82.550 3.2500	26.195 1.0313	92900 20900	0.40	1.49	24100 5420	16600 3730	1.45	115000 25800		22780	22720	
42.862 1.6875	82.931 3.2650	23.812 0.9375	90500 20300	0.33	1.79	23500 5270	13500 3020	1.74	111000 24900		25578	25520	
42.862 1.6875	82.931 3.2650	26.988 1.0625	90500 20300	0.33	1.79	23500 5270	13500 3020	1.74	111000 24900		25578	25523	
42.862 1.6875	83.058 3.2700	23.812 0.9375	90500 20300	0.33	1.79	23500 5270	13500 3020	1.74	111000 24900		25576	25521	
42.862 1.6875	83.058 3.2700	23.876 0.9400	90500 20300	0.33	1.79	23500 5270	13500 3020	1.74	111000 24900		25578	25522	
42.862 1.6875	87.312 3.4375	30.162 1.1875	113000 25500	0.31	1.96	29400 6610	15400 3460	1.91	134000 30100		3579	3525	
42.862 1.6875	114.300 4.5000	44.450 1.7500	224000 50300	0.43	1.39	58000 13000	42700 9600	1.36	256000 57500		65383	65320	
42.875 1.6880	76.200 3.0000	25.400 1.0000	91100 20500	0.32	1.88	23600 5310	12900 2900	1.83	110000 24800		26884	26823	
42.875 1.6880	79.375 3.1250	23.812 0.9375	91100 20500	0.32	1.88	23600 5310	12900 2900	1.83	110000 24800		26884	26822	

<sup>(1)</sup>Based on 1 x 10<sup>6</sup> revolutions L<sub>10</sub> life, for the ISO life-calculation method.

<sup>(2)</sup>Consult your Timken engineer for instructions on use or review the Timken Engineering Manual on timken.com/catalogs.

<sup>(3)</sup>Based on 90 x 10<sup>6</sup> revolutions L<sub>10</sub> life, for The Timken Company life-calculation method. C<sub>90</sub> and C<sub>a90</sub> are radial and thrust values.

Bearing Dimensions											Geometry Factors			Bearing Weight
Width B	Width C	Eff. Ctr. a <sup>(4)</sup>	Shaft			Housing			Cage		G <sub>1</sub>	G <sub>2</sub>	C <sub>g</sub>	
			Max Shaft Fillet Radius R <sup>(5)</sup>	Backing Shoulder Dia. d <sub>a</sub>	Shoulder Dia. d <sub>b</sub>	Max Housing Fillet Radius r <sup>(5)</sup>	Backing Shoulder Dia. D <sub>a</sub>	Shoulder Dia. D <sub>b</sub>	A <sub>a</sub> <sup>(6)</sup>	A <sub>b</sub> <sup>(7)</sup>				
mm in.	mm in.	mm in.	mm in.	mm in.	mm in.	mm in.	mm in.	mm in.	mm in.	mm in.				kg lbs.
29.317 1.1542	22.225 0.8750	-7.1 -0.28	2.3 0.09	52.0 2.05	56.0 2.20	0.8 0.03	100.0 3.94	97.0 3.82	2.1 0.08	1.4 0.06	58.6	17.1	0.0946	1.38 3.05
36.957 1.4550	28.575 1.1250	-12.2 -0.48	3.5 0.14	51.0 2.01	58.0 2.28	3.3 0.13	100.0 3.94	94.0 3.70	2.7 0.10	1.0 0.04	64.3	16.1	0.0938	1.72 3.80
17.384 0.6844	14.288 0.5625	-0.8 -0.03	1.8 0.07	47.0 1.85	50.0 1.97	1.5 0.06	73.0 2.87	69.0 2.72	* *	* *	19.2	16.0	0.0735	0.38 0.83
29.317 1.1542	24.605 0.9687	-7.1 -0.28	0.8 0.03	53.0 2.09	54.0 2.13	3.3 0.13	98.0 3.86	92.0 3.62	2.1 0.08	1.4 0.06	58.6	17.1	0.0946	1.31 2.88
29.317 1.1542	27.000 1.0630	-7.1 -0.28	0.8 0.03	53.0 2.09	54.0 2.13	0.8 0.03	100.0 3.94	97.0 3.82	2.1 0.08	1.4 0.06	58.6	17.1	0.0946	1.42 3.12
29.317 1.1542	27.000 1.0630	-7.1 -0.28	0.8 0.03	53.0 2.09	54.0 2.13	2.0 0.08	100.0 3.94	96.0 3.78	2.1 0.08	1.4 0.06	58.6	17.1	0.0946	1.49 3.28
17.145 0.6750	11.908 0.4688	0.0 0.00	1.5 0.06	48.5 1.91	51.0 2.01	1.5 0.06	73.0 2.87	68.0 2.68	1.4 0.05	2.2 0.09	21.0	17.5	0.0766	0.33 0.71
19.837 0.7810	15.080 0.5937	-2.5 -0.10	2.3 0.09	48.5 1.91	52.0 2.05	1.5 0.06	76.0 2.99	73.0 2.87	1.1 0.04	1.8 0.07	23.7	14.4	0.0758	0.44 0.98
26.988 1.0625	20.638 0.8125	-6.4 -0.25	3.5 0.14	50.0 1.97	56.0 2.20	3.3 0.13	77.0 3.03	71.0 2.80	1.8 0.07	1.1 0.05	33.9	15.3	0.0841	0.60 1.32
25.400 1.0000	19.050 0.7500	-6.4 -0.25	2.3 0.09	49.5 1.95	53.0 2.09	0.8 0.03	77.0 3.03	74.0 2.91	1.0 0.04	0.7 0.03	35.2	14.3	0.0801	0.58 1.28
25.400 1.0000	22.225 0.8750	-6.4 -0.25	2.3 0.09	49.5 1.95	53.0 2.09	2.3 0.09	77.0 3.03	72.0 2.83	1.0 0.04	0.7 0.03	35.2	14.3	0.0801	0.62 1.37
25.400 1.0000	19.050 0.7500	-6.4 -0.25	3.5 0.14	49.0 1.93	55.0 2.17	3.3 0.13	77.0 3.03	72.0 2.83	1.0 0.04	0.7 0.03	35.2	14.3	0.0801	0.57 1.26
25.400 1.0000	19.114 0.7525	-6.4 -0.25	2.3 0.09	49.5 1.95	53.0 2.09	2.0 0.08	77.0 3.03	73.0 2.87	1.0 0.04	0.7 0.03	35.2	14.3	0.0801	0.58 1.29
30.886 1.2160	23.812 0.9375	-10.2 -0.40	3.5 0.14	49.5 1.95	56.0 2.20	3.3 0.13	81.0 3.19	75.0 2.95	2.2 0.09	0.7 0.03	39.5	12.5	0.0808	0.80 1.74
44.450 1.7500	34.925 1.3750	-12.4 -0.49	2.0 0.08	60.0 2.36	63.0 2.48	3.3 0.13	107.0 4.21	97.0 3.82	3.6 0.14	1.1 0.05	63.1	13.0	0.1053	2.35 5.19
25.400 1.0000	20.638 0.8125	-7.4 -0.29	3.5 0.14	48.5 1.91	55.0 2.17	1.5 0.06	73.0 2.87	69.0 2.72	1.4 0.05	1.3 0.05	32.8	13.3	0.0770	0.46 1.01
25.400 1.0000	19.050 0.7500	-7.4 -0.29	3.5 0.14	48.5 1.91	55.0 2.17	0.8 0.03	74.0 2.91	71.0 2.80	1.4 0.05	1.3 0.05	32.8	13.3	0.0770	0.50 1.11

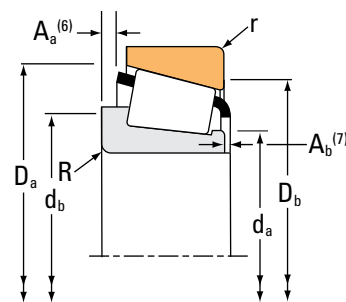
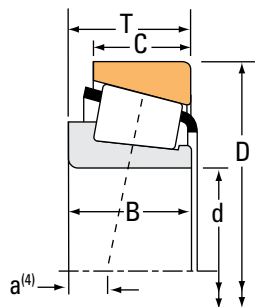
(4) Negative value indicates effective center inside cone (inner-ring) backface.  
 (5) These maximum fillet radii will be cleared by the bearing corners.  
 (6) Negative value indicates cage extends beyond cone (inner-ring) backface.  
 (7) Negative value indicates cage that does not extend beyond cone (inner-ring) front face.  
 (\*) Contact your Timken engineer for details.

Continued on next page.

# TAPERED ROLLER BEARINGS

## SINGLE-ROW • TYPE TS

### TYPE TS



Bearing Dimensions			Load Ratings							Part Number		
Bore d	O.D. D	Width T	Dynamic <sup>(1)</sup>		Factors <sup>(2)</sup>		Dynamic <sup>(3)</sup>		Factors <sup>(2)</sup>	Static	Inner	Outer
			C <sub>1</sub>	e	Y	C <sub>90</sub>	C <sub>a90</sub>	K	C <sub>0</sub>			
mm in.	mm in.	mm in.	N lbf			N lbf	N lbf		N lbf			
42.875 1.6880	80.000 3.1496	21.000 0.8268	94300 21200	0.27	2.20	24400 5490	11400 2570	2.14	83400 18700		342-S	332
42.875 1.6880	80.000 3.1496	23.812 0.9375	91100 20500	0.32	1.88	23600 5310	12900 2900	1.83	110000 24800		26884	26824
42.875 1.6880	80.000 3.1496	24.176 0.9518	94300 21200	0.27	2.20	24400 5490	11400 2570	2.14	83400 18700		342-S	332A
42.875 1.6880	80.167 3.1562	25.400 1.0000	91100 20500	0.32	1.88	23600 5310	12900 2900	1.83	110000 24800		26886	26830
42.875 1.6880	80.167 3.1562	25.400 1.0000	91100 20500	0.32	1.88	23600 5310	12900 2900	1.83	110000 24800		26886	26820
42.875 1.6880	81.973 3.2273	23.876 0.9400	90500 20300	0.33	1.79	23500 5270	13500 3020	1.74	111000 24900		25577	25518
42.875 1.6880	82.550 3.2500	23.812 0.9375	90500 20300	0.33	1.79	23500 5270	13500 3020	1.74	111000 24900		25577	25519
42.875 1.6880	82.931 3.2650	23.812 0.9375	90500 20300	0.33	1.79	23500 5270	13500 3020	1.74	111000 24900		25577	25520
42.875 1.6880	82.931 3.2650	26.988 1.0625	90500 20300	0.33	1.79	23500 5270	13500 3020	1.74	111000 24900		25577	25523
42.875 1.6880	83.058 3.2700	23.876 0.9400	90500 20300	0.33	1.79	23500 5270	13500 3020	1.74	111000 24900		25577	25522
42.987 1.6924	74.988 2.9523	19.368 0.7625	59500 13400	0.44	1.35	15400 3470	11700 2640	1.31	73500 16500		16986	16929
42.987 1.6924	79.375 3.1250	20.638 0.8125	68900 15500	0.37	1.64	17900 4020	11200 2510	1.60	83300 18700		17886	17830
42.987 1.6924	79.985 3.1490	19.842 0.7812	68900 15500	0.37	1.64	17900 4020	11200 2510	1.60	83300 18700		17886	17831
44.450 1.7500	71.438 2.8125	12.700 0.5000	36100 8110	0.31	1.97	9350 2100	4890 1100	1.91	43600 9790		LL103049	LL103010
44.450 1.7500	73.025 2.8750	18.258 0.7188	57000 12800	0.32	1.88	14800 3320	8060 1810	1.83	78300 17600		L102849	L102810
44.450 1.7500	76.992 3.0312	17.462 0.6875	49500 11100	0.51	1.19	12800 2890	11100 2500	1.15	58100 13100		12175	12303
44.450 1.7500	79.375 3.1250	17.462 0.6875	52000 11700	0.37	1.60	13500 3030	8630 1940	1.56	61300 13800		18685	18620

<sup>(1)</sup>Based on  $1 \times 10^6$  revolutions  $L_{10}$  life, for the ISO life-calculation method.

<sup>(2)</sup>Consult your Timken engineer for instructions on use or review the Timken Engineering Manual on [timken.com/catalogs](http://timken.com/catalogs).

<sup>(3)</sup>Based on  $90 \times 10^6$  revolutions  $L_{10}$  life, for The Timken Company life-calculation method.  $C_{90}$  and  $C_{a90}$  are radial and thrust values.



Bearing Dimensions											Geometry Factors			Bearing Weight
Width B	Width C	Eff. Ctr. a <sup>(4)</sup>	Shaft			Housing			Cage		G <sub>1</sub>	G <sub>2</sub>	C <sub>g</sub>	
			Max Shaft Fillet Radius R <sup>(5)</sup>	Backing Shoulder Dia. d <sub>a</sub>	Backing Shoulder Dia. d <sub>b</sub>	Max Housing Fillet Radius r <sup>(5)</sup>	Backing Shoulder Dia. D <sub>a</sub>	Backing Shoulder Dia. D <sub>b</sub>	A <sub>a</sub> <sup>(6)</sup>	A <sub>b</sub> <sup>(7)</sup>				
mm in.	mm in.	mm in.	mm in.	mm in.	mm in.	mm in.	mm in.	mm in.	mm in.	mm in.				kg lbs.
22.403 0.8820	17.826 0.7018	-6.4 -0.25	3.5 0.14	47.5 1.87	54.0 2.13	1.3 0.05	75.0 2.95	73.0 2.87	0.7 0.02	1.1 0.05	26.5	13.0	0.0676	0.43 0.97
25.400 1.0000	19.050 0.7500	-7.4 -0.29	3.5 0.14	48.5 1.91	55.0 2.17	1.3 0.05	74.0 2.91	70.0 2.76	1.4 0.05	1.3 0.05	32.8	13.3	0.0770	0.52 1.13
22.403 0.8820	21.000 0.8268	-6.4 -0.25	3.5 0.14	47.5 1.87	54.0 2.13	2.3 0.09	75.0 2.95	71.0 2.80	0.7 0.02	1.1 0.05	26.5	13.0	0.0676	0.47 1.05
25.400 1.0000	20.638 0.8125	-7.4 -0.29	1.5 0.06	48.5 1.91	51.0 2.01	0.8 0.03	74.0 2.91	71.0 2.80	1.4 0.05	1.3 0.05	32.8	13.3	0.0770	0.54 1.20
25.400 1.0000	20.638 0.8125	-7.4 -0.29	1.5 0.06	48.5 1.91	51.0 2.01	3.3 0.13	74.0 2.91	69.0 2.72	1.4 0.05	1.3 0.05	32.8	13.3	0.0770	0.53 1.18
25.400 1.0000	19.114 0.7525	-6.4 -0.25	3.5 0.14	49.0 1.93	55.0 2.17	1.0 0.04	77.0 3.03	74.0 2.91	1.0 0.04	0.7 0.03	35.2	14.3	0.0801	0.56 1.23
25.400 1.0000	19.050 0.7500	-6.4 -0.25	3.5 0.14	49.0 1.93	55.0 2.17	2.0 0.08	77.0 3.03	73.0 2.87	1.0 0.04	0.7 0.03	35.2	14.3	0.0801	0.57 1.25
25.400 1.0000	19.050 0.7500	-6.4 -0.25	3.5 0.14	49.0 1.93	55.0 2.17	0.8 0.03	77.0 3.03	74.0 2.91	1.0 0.04	0.7 0.03	35.2	14.3	0.0801	0.58 1.27
25.400 1.0000	22.225 0.8750	-6.4 -0.25	3.5 0.14	49.0 1.93	55.0 2.17	2.3 0.09	77.0 3.03	72.0 2.83	1.0 0.04	0.7 0.03	35.2	14.3	0.0801	0.62 1.37
25.400 1.0000	19.114 0.7525	-6.4 -0.25	3.5 0.14	49.0 1.93	55.0 2.17	2.0 0.08	77.0 3.03	73.0 2.87	1.0 0.04	0.7 0.03	35.2	14.3	0.0801	0.58 1.28
19.837 0.7810	14.288 0.5625	-2.0 -0.08	1.5 0.06	48.5 1.91	51.0 2.01	1.3 0.05	71.0 2.80	68.0 2.68	* *	* *	25.1	17.4	0.0783	0.36 0.79
20.638 0.8125	15.875 0.6250	-3.8 -0.15	1.5 0.06	49.0 1.93	51.0 2.01	2.0 0.08	75.0 2.95	71.0 2.80	1.1 0.04	1.3 0.06	28.9	17.9	0.0770	0.42 0.94
20.638 0.8125	15.080 0.5937	-3.8 -0.15	1.5 0.06	49.0 1.93	51.0 2.01	1.3 0.05	75.0 2.95	72.0 2.83	1.1 0.04	1.3 0.06	28.9	17.9	0.0770	0.42 0.94
12.700 0.5000	9.525 0.3750	-1.3 -0.05	1.5 0.06	48.5 1.91	51.0 2.01	1.5 0.06	68.0 2.68	65.0 2.56	0.0 0.00	1.6 0.07	20.0	23.6	0.0637	0.18 0.39
18.258 0.7188	15.083 0.5938	-3.8 -0.15	1.5 0.06	49.0 1.93	51.0 2.01	1.5 0.06	69.0 2.72	66.0 2.60	0.0 0.00	1.8 0.07	30.6	25.9	0.0751	0.29 0.65
17.145 0.6750	11.908 0.4688	0.0 0.00	1.5 0.06	49.5 1.95	52.0 2.05	1.5 0.06	73.0 2.87	68.0 2.68	1.4 0.05	2.2 0.09	21.0	17.5	0.0766	0.31 0.68
17.462 0.6875	13.495 0.5313	-2.0 -0.08	2.8 0.11	49.5 1.95	54.0 2.13	1.5 0.06	74.0 2.91	71.0 2.80	0.7 0.02	1.6 0.07	23.9	18.7	0.0725	0.34 0.76

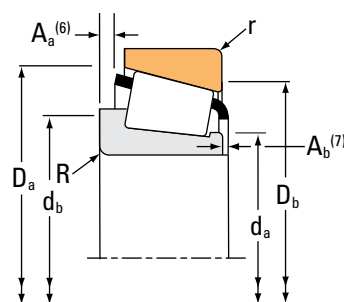
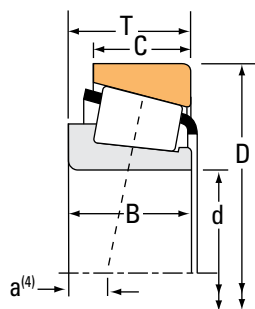
<sup>(4)</sup>Negative value indicates effective center inside cone (inner-ring) backface.  
<sup>(5)</sup>These maximum fillet radii will be cleared by the bearing corners.  
<sup>(6)</sup>Negative value indicates cage extends beyond cone (inner-ring) backface.  
<sup>(7)</sup>Negative value indicates cage that does not extend beyond cone (inner-ring) front face.  
<sup>(\*)</sup>Contact your Timken engineer for details.

Continued on next page.

# TAPERED ROLLER BEARINGS

## SINGLE-ROW • TYPE TS

### TYPE TS



Bearing Dimensions			Load Ratings							Part Number			
Bore d	O.D. D	Width T	Dynamic <sup>(1)</sup>		Factors <sup>(2)</sup>		Dynamic <sup>(3)</sup>		Factors <sup>(2)</sup>		Static C <sub>0</sub>	Inner	Outer
			C <sub>1</sub>	e	Y	C <sub>90</sub>	C <sub>a90</sub>	K	N	N			
mm in.	mm in.	mm in.	N lbf			N lbf	N lbf		N lbf				
44.450 1.7500	80.962 3.1875	19.050 0.7500	50800 11400	0.53	1.14	13200 2960	11900 2680	1.11	61100 13700		13175	13318	
44.450 1.7500	82.550 3.2500	23.812 0.9375	90500 20300	0.33	1.79	23500 5270	13500 3020	1.74	111000 24900		25580	25519	
44.450 1.7500	82.550 3.2500	23.812 0.9375	90500 20300	0.33	1.79	23500 5270	13500 3020	1.74	111000 24900		25582	25519	
44.450 1.7500	82.550 3.2500	34.290 1.3500	90500 20300	0.33	1.79	23500 5270	13500 3020	1.74	111000 24900		25583	25519	
44.450 1.7500	82.931 3.2650	22.225 0.8750	82800 18600	0.30	2.02	21500 4820	10900 2460	1.96	89200 20100		35175	35326	
44.450 1.7500	82.931 3.2650	22.225 0.8750	98100 22100	0.30	2.02	25400 5720	13000 2910	1.96	89200 20100		35176	35326	
44.450 1.7500	82.931 3.2650	23.812 0.9375	90500 20300	0.33	1.79	23500 5270	13500 3020	1.74	111000 24900		25580	25520	
44.450 1.7500	82.931 3.2650	23.812 0.9375	90500 20300	0.33	1.79	23500 5270	13500 3020	1.74	111000 24900		25581	25520	
44.450 1.7500	82.931 3.2650	23.812 0.9375	90500 20300	0.33	1.79	23500 5270	13500 3020	1.74	111000 24900		25580	25524	
44.450 1.7500	82.931 3.2650	23.812 0.9375	90500 20300	0.33	1.79	23500 5270	13500 3020	1.74	111000 24900		25582	25520	
44.450 1.7500	82.931 3.2650	26.988 1.0625	90500 20300	0.33	1.79	23500 5270	13500 3020	1.74	111000 24900		25580	25523	
44.450 1.7500	82.931 3.2650	34.290 1.3500	90500 20300	0.33	1.79	23500 5270	13500 3020	1.74	111000 24900		25583	25524	
44.450 1.7500	82.931 3.2650	34.290 1.3500	90500 20300	0.33	1.79	23500 5270	13500 3020	1.74	111000 24900		25583	25520	
44.450 1.7500	83.058 3.2700	23.812 0.9375	90500 20300	0.33	1.79	23500 5270	13500 3020	1.74	111000 24900		25580	25521	
44.450 1.7500	83.058 3.2700	23.812 0.9375	90500 20300	0.33	1.79	23500 5270	13500 3020	1.74	111000 24900		25581	25521	
44.450 1.7500	83.058 3.2700	23.812 0.9375	90500 20300	0.33	1.79	23500 5270	13500 3020	1.74	111000 24900		25582	25521	
44.450 1.7500	83.058 3.2700	23.876 0.9400	90500 20300	0.33	1.79	23500 5270	13500 3020	1.74	111000 24900		25580	25522	

<sup>(1)</sup>Based on 1 x 10<sup>6</sup> revolutions L<sub>10</sub> life, for the ISO life-calculation method.

<sup>(2)</sup>Consult your Timken engineer for instructions on use or review the Timken Engineering Manual on timken.com/catalogs.

<sup>(3)</sup>Based on 90 x 10<sup>6</sup> revolutions L<sub>10</sub> life, for The Timken Company life-calculation method. C<sub>90</sub> and C<sub>a90</sub> are radial and thrust values.

Bearing Dimensions											Geometry Factors			Bearing Weight
Width B	Width C	Eff. Ctr. a <sup>(4)</sup>	Shaft			Housing			Cage		G <sub>1</sub>	G <sub>2</sub>	C <sub>g</sub>	
			Max Shaft Fillet Radius R <sup>(5)</sup>	Backing Shoulder Dia. d <sub>a</sub> d <sub>b</sub>		Max Housing Fillet Radius r <sup>(5)</sup>	Backing Shoulder Dia. D <sub>a</sub> D <sub>b</sub>		A <sub>a</sub> <sup>(6)</sup>	A <sub>b</sub> <sup>(7)</sup>				
mm in.	mm in.	mm in.	mm in.	mm in.	mm in.	mm in.	mm in.	mm in.	mm in.	mm in.				kg lbs.
17.462 0.6875	14.288 0.5625	0.8 0.03	0.1 0.01	50.0 1.97	50.0 1.97	1.5 0.06	76.0 2.99	72.0 2.83	1.6 0.06	2.0 0.08	23.0	19.2	0.0799	0.39 0.86
25.400 1.0000	19.050 0.7500	-6.4 -0.25	3.5 0.14	50.0 1.97	57.0 2.24	2.0 0.08	77.0 3.03	73.0 2.87	0.9 0.03	0.8 0.03	35.2	14.3	0.0801	0.55 1.20
25.400 1.0000	19.050 0.7500	-6.4 -0.25	5.0 0.20	50.0 1.97	60.0 2.36	2.0 0.08	77.0 3.03	73.0 2.87	1.0 0.04	0.7 0.03	35.2	14.3	0.0801	0.54 1.18
35.878 1.4125	19.050 0.7500	-16.8 -0.66	0.0 0.00	50.0 1.97	65.0 2.56	2.0 0.08	77.0 3.03	73.0 2.87	11.4 0.45	0.7 0.03	35.2	14.3	0.0801	0.67 1.46
23.012 0.9060	17.462 0.6875	-6.1 -0.24	3.5 0.14	49.5 1.95	56.0 2.20	0.8 0.03	78.0 3.07	76.0 2.99	1.1 0.04	1.2 0.05	29.1	12.0	0.0718	0.49 1.07
23.012 0.9060	17.462 0.6875	-6.1 -0.24	0.8 0.03	49.5 1.95	50.0 1.97	0.8 0.03	78.0 3.07	76.0 2.99	1.1 0.04	1.2 0.05	29.1	12.0	0.0718	0.50 1.09
25.400 1.0000	19.050 0.7500	-6.4 -0.25	3.5 0.14	50.0 1.97	57.0 2.24	0.8 0.03	77.0 3.03	74.0 2.91	0.9 0.03	0.8 0.03	35.2	14.3	0.0801	0.56 1.22
25.400 1.0000	19.050 0.7500	-6.4 -0.25	0.5 0.02	50.0 1.97	51.0 2.01	0.8 0.03	77.0 3.03	74.0 2.91	1.0 0.04	0.7 0.03	35.2	14.3	0.0801	0.56 1.24
25.400 1.0000	19.050 0.7500	-6.4 -0.25	3.5 0.14	50.0 1.97	57.0 2.24	2.3 0.09	77.0 3.03	73.0 2.87	0.9 0.03	0.8 0.03	35.2	14.3	0.0801	0.56 1.21
25.400 1.0000	19.050 0.7500	-6.4 -0.25	5.0 0.20	50.0 1.97	60.0 2.36	0.8 0.03	77.0 3.03	74.0 2.91	1.0 0.04	0.7 0.03	35.2	14.3	0.0801	0.55 1.21
25.400 1.0000	22.225 0.8750	-6.4 -0.25	3.5 0.14	50.0 1.97	57.0 2.24	2.3 0.09	77.0 3.03	72.0 2.83	0.9 0.03	0.8 0.03	35.2	14.3	0.0801	0.60 1.32
35.878 1.4125	19.050 0.7500	-16.8 -0.66	0.0 0.00	50.0 1.97	65.0 2.56	2.3 0.09	77.0 3.03	73.0 2.87	11.4 0.45	0.7 0.03	35.2	14.3	0.0801	0.68 1.48
35.878 1.4125	19.050 0.7500	-16.8 -0.66	0.0 0.00	50.0 1.97	65.0 2.56	0.8 0.03	77.0 3.03	74.0 2.91	11.4 0.45	0.7 0.03	35.2	14.3	0.0801	0.68 1.49
25.400 1.0000	19.050 0.7500	-6.4 -0.25	3.5 0.14	50.0 1.97	57.0 2.24	3.3 0.13	77.0 3.03	72.0 2.83	0.9 0.03	0.8 0.03	35.2	14.3	0.0801	0.55 1.21
25.400 1.0000	19.050 0.7500	-6.4 -0.25	0.5 0.02	50.0 1.97	51.0 2.01	3.3 0.13	77.0 3.03	72.0 2.83	1.0 0.04	0.7 0.03	35.2	14.3	0.0801	0.55 1.22
25.400 1.0000	19.050 0.7500	-6.4 -0.25	5.0 0.20	50.0 1.97	60.0 2.36	3.3 0.13	77.0 3.03	72.0 2.83	1.0 0.04	0.7 0.03	35.2	14.3	0.0801	0.54 1.19
25.400 1.0000	19.114 0.7525	-6.4 -0.25	3.5 0.14	50.0 1.97	57.0 2.24	2.0 0.08	77.0 3.03	73.0 2.87	0.9 0.03	0.8 0.03	35.2	14.3	0.0801	0.56 1.23

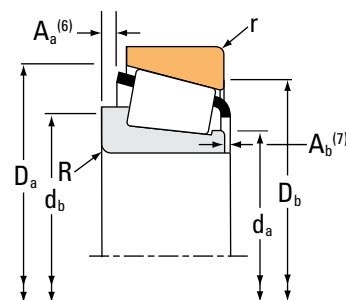
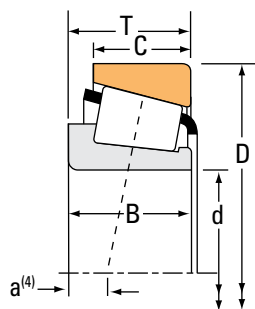
<sup>(4)</sup>Negative value indicates effective center inside cone (inner-ring) backface.  
<sup>(5)</sup>These maximum fillet radii will be cleared by the bearing corners.  
<sup>(6)</sup>Negative value indicates cage extends beyond cone (inner-ring) backface.  
<sup>(7)</sup>Negative value indicates cage that does not extend beyond cone (inner-ring) front face.

Continued on next page.

# TAPERED ROLLER BEARINGS

## SINGLE-ROW • TYPE TS

### TYPE TS



Bearing Dimensions			Load Ratings							Part Number		
Bore d	O.D. D	Width T	Dynamic <sup>(1)</sup>		Factors <sup>(2)</sup>		Dynamic <sup>(3)</sup>		Factors <sup>(2)</sup>	Static	Inner	Outer
			C <sub>1</sub>	e	Y	C <sub>90</sub>	C <sub>a90</sub>	K	C <sub>0</sub>			
mm in.	mm in.	mm in.	N lbf			N lbf	N lbf			N lbf		
44.450 1.7500	84.138 3.3125	26.988 1.0625	97000 21800	0.31	1.96	25100 5650	13200 2960	1.91	88800 20000	355	3520	
44.450 1.7500	84.138 3.3125	30.163 1.1875	113000 25500	0.31	1.96	29400 6610	15400 3460	1.91	134000 30100	3578	3520	
44.450 1.7500	85.000 3.3465	20.638 0.8125	97000 21800	0.31	1.96	25100 5650	13200 2960	1.91	88800 20000	355	354A	
44.450 1.7500	85.000 3.3465	20.638 0.8125	97000 21800	0.31	1.96	25100 5650	13200 2960	1.91	88800 20000	355X	354A	
44.450 1.7500	85.000 3.3465	20.638 0.8125	97000 21800	0.31	1.96	25100 5650	13200 2960	1.91	88800 20000	355A	354A	
44.450 1.7500	85.000 3.3465	23.812 0.9375	90500 20300	0.33	1.79	23500 5270	13500 3020	1.74	111000 24900	25580	25526	
44.450 1.7500	85.000 3.3465	25.400 1.0000	93300 21000	0.35	1.73	24200 5440	14300 3220	1.69	117000 26200	2975	2924	
44.450 1.7500	87.312 3.4375	26.988 1.0625	97000 21800	0.31	1.96	25100 5650	13200 2960	1.91	88800 20000	355	3525	
44.450 1.7500	87.312 3.4375	26.988 1.0625	93300 21000	0.35	1.73	24200 5440	14300 3220	1.69	117000 26200	2975	2925	
44.450 1.7500	87.312 3.4375	30.162 1.1875	113000 25500	0.31	1.96	29400 6610	15400 3460	1.91	134000 30100	3578	3525	
44.450 1.7500	87.312 3.4375	30.162 1.1875	113000 25500	0.31	1.96	29400 6610	15400 3460	1.91	134000 30100	3578	3526	
44.450 1.7500	87.312 3.4375	30.162 1.1875	113000 25500	0.31	1.96	29400 6610	15400 3460	1.91	134000 30100	3578A	3525	
44.450 1.7500	88.900 3.5000	30.162 1.1875	114000 25600	0.55	1.10	29500 6630	27600 6200	1.07	144000 32400	HM803149	HM803110	
44.450 1.7500	88.900 3.5000	30.162 1.1875	114000 25600	0.55	1.10	29500 6630	27600 6200	1.07	144000 32400	HM803149	HM803111	
44.450 1.7500	90.119 3.5480	23.000 0.9055	97000 21800	0.31	1.96	25100 5650	13200 2960	1.91	88800 20000	355X	352	
44.450 1.7500	93.264 3.6718	30.162 1.1875	122000 27500	0.34	1.77	31700 7120	18300 4120	1.73	153000 34300	3782	3720	
44.450 1.7500	93.662 3.6875	31.750 1.2500	136000 30500	0.36	1.67	35200 7900	21700 4870	1.62	156000 35000	49175	49368	

<sup>(1)</sup>Based on 1 x 10<sup>6</sup> revolutions L<sub>10</sub> life, for the ISO life-calculation method.

<sup>(2)</sup>Consult your Timken engineer for instructions on use or review the Timken Engineering Manual on timken.com/catalogs.

<sup>(3)</sup>Based on 90 x 10<sup>6</sup> revolutions L<sub>10</sub> life, for The Timken Company life-calculation method. C<sub>90</sub> and C<sub>a90</sub> are radial and thrust values.

Bearing Dimensions											Geometry Factors			Bearing Weight
Width B	Width C	Eff. Ctr. a <sup>(4)</sup>	Shaft			Housing			Cage		G <sub>1</sub>	G <sub>2</sub>	C <sub>g</sub>	
			Max Shaft Fillet Radius R <sup>(5)</sup>	Backing Shoulder Dia. d <sub>a</sub>	Backing Shoulder Dia. d <sub>b</sub>	Max Housing Fillet Radius r <sup>(5)</sup>	Backing Shoulder Dia. D <sub>a</sub>	Backing Shoulder Dia. D <sub>b</sub>	A <sub>a</sub> <sup>(6)</sup>	A <sub>b</sub> <sup>(7)</sup>				
mm in.	mm in.	mm in.	mm in.	mm in.	mm in.	mm in.	mm in.	mm in.	mm in.	mm in.				kg lbs.
21.692 0.8540	23.812 0.9375	-4.8 -0.19	2.3 0.09	50.0 1.97	54.0 2.13	3.3 0.13	79.5 3.13	74.0 2.91	0.4 0.01	1.7 0.07	30.0	12.2	0.0732	0.57 1.25
30.886 1.2160	23.812 0.9375	-10.2 -0.40	3.5 0.14	51.0 2.01	57.0 2.24	3.3 0.13	79.5 3.13	74.0 2.91	2.2 0.09	0.7 0.03	39.5	12.5	0.0808	0.69 1.51
21.692 0.8540	17.462 0.6875	-4.8 -0.19	2.3 0.09	50.0 1.97	54.0 2.13	1.3 0.05	80.0 3.15	77.0 3.03	0.4 0.01	1.7 0.07	30.0	12.2	0.0732	0.51 1.12
21.692 0.8540	17.462 0.6875	-4.8 -0.19	3.5 0.14	50.0 1.97	56.0 2.20	1.3 0.05	80.0 3.15	77.0 3.03	0.4 0.01	1.7 0.07	30.0	12.2	0.0732	0.50 1.11
21.692 0.8540	17.462 0.6875	-4.8 -0.19	0.8 0.03	50.0 1.97	51.0 2.01	1.3 0.05	80.0 3.15	77.0 3.03	0.4 0.01	1.7 0.07	30.0	12.2	0.0732	0.51 1.13
25.400 1.0000	19.050 0.7500	-6.4 -0.25	3.5 0.14	50.0 1.97	57.0 2.24	2.3 0.09	78.0 3.07	74.0 2.91	0.9 0.03	0.8 0.03	35.2	14.3	0.0801	0.60 1.30
25.608 1.0082	20.638 0.8125	-6.4 -0.25	3.5 0.14	51.0 2.01	57.0 2.24	1.3 0.05	80.0 3.15	76.0 2.99	1.7 0.07	1.1 0.05	38.2	15.7	0.0832	0.63 1.39
21.692 0.8540	23.812 0.9375	-4.8 -0.19	2.3 0.09	50.0 1.97	54.0 2.13	3.3 0.13	81.0 3.19	75.0 2.95	0.4 0.01	1.7 0.07	30.0	12.2	0.0732	0.65 1.42
25.608 1.0082	22.225 0.8750	-6.4 -0.25	3.5 0.14	51.0 2.01	57.0 2.24	2.3 0.09	81.0 3.19	75.0 2.95	1.7 0.07	1.1 0.05	38.2	15.7	0.0832	0.70 1.55
30.886 1.2160	23.812 0.9375	-10.2 -0.40	3.5 0.14	51.0 2.01	57.0 2.24	3.3 0.13	81.0 3.19	75.0 2.95	2.2 0.09	0.7 0.03	39.5	12.5	0.0808	0.77 1.68
30.886 1.2160	23.812 0.9375	-10.2 -0.40	3.5 0.14	51.0 2.01	57.0 2.24	0.8 0.03	81.0 3.19	77.0 3.03	2.2 0.09	0.7 0.03	39.5	12.5	0.0808	0.78 1.71
30.886 1.2160	23.812 0.9375	-10.2 -0.40	5.5 0.22	51.0 2.01	61.0 2.40	3.3 0.13	81.0 3.19	75.0 2.95	2.2 0.09	0.7 0.03	39.5	12.5	0.0808	0.76 1.66
29.370 1.1563	23.020 0.9063	-4.3 -0.17	3.5 0.14	53.4 2.10	62.0 2.44	3.3 0.13	85.0 3.35	74.0 2.91	1.5 0.05	2.2 0.09	39.2	10.6	0.0974	0.84 1.85
29.370 1.1563	23.020 0.9063	-4.3 -0.17	3.5 0.14	53.4 2.10	62.0 2.44	0.8 0.03	85.0 3.35	76.0 2.99	1.5 0.05	2.2 0.09	39.2	10.6	0.0974	0.85 1.88
21.692 0.8540	21.808 0.8586	-4.8 -0.19	3.5 0.14	50.0 1.97	56.0 2.20	2.3 0.09	82.0 3.23	78.0 3.07	0.4 0.01	1.7 0.07	30.0	12.2	0.0732	0.66 1.46
30.302 1.1930	23.812 0.9375	-8.1 -0.32	3.5 0.14	52.0 2.05	58.0 2.28	3.3 0.13	87.9 3.46	82.0 3.23	1.8 0.07	1.0 0.04	49.9	14.5	0.0903	0.97 2.12
31.750 1.2500	25.400 1.0000	-9.1 -0.36	3.5 0.14	53.0 2.09	59.0 2.32	3.3 0.13	87.0 3.43	82.0 3.23	2.9 0.11	0.8 0.04	42.4	13.6	0.0872	0.98 2.15

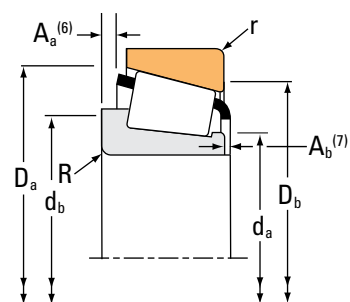
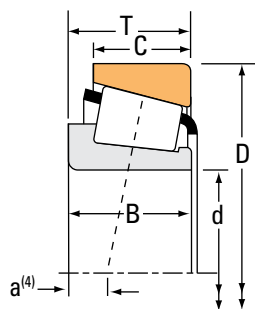
<sup>(4)</sup>Negative value indicates effective center inside cone (inner-ring) backface.  
<sup>(5)</sup>These maximum fillet radii will be cleared by the bearing corners.  
<sup>(6)</sup>Negative value indicates cage extends beyond cone (inner-ring) backface.  
<sup>(7)</sup>Negative value indicates cage that does not extend beyond cone (inner-ring) front face.

Continued on next page.

# TAPERED ROLLER BEARINGS

## SINGLE-ROW • TYPE TS

### TYPE TS



Bearing Dimensions			Load Ratings							Part Number		
Bore d	O.D. D	Width T	Dynamic <sup>(1)</sup>		Factors <sup>(2)</sup>		Dynamic <sup>(3)</sup>		Factors <sup>(2)</sup>	Static	Inner	Outer
			C <sub>1</sub>	e	Y	C <sub>90</sub>	C <sub>a90</sub>	K	C <sub>0</sub>			
mm in.	mm in.	mm in.	N lbf			N lbf	N lbf			N lbf		
44.450 1.7500	93.662 3.6875	31.750 1.2500	136000 30500	0.36	1.67	35200 7900	21700 4870	1.62		156000 35000	49176	49368
44.450 1.7500	93.662 3.6875	31.750 1.2500	129000 29100	0.40	1.49	33500 7540	23100 5190	1.45		158000 35500	46175	46368
44.450 1.7500	93.662 3.6875	31.750 1.2500	129000 29100	0.40	1.49	33500 7540	23100 5190	1.45		158000 35500	46176	46368
44.450 1.7500	95.250 3.7500	27.783 1.0938	127000 28500	0.28	2.11	32900 7400	16000 3600	2.05		144000 32400	438	432
44.450 1.7500	95.250 3.7500	27.783 1.0938	127000 28500	0.28	2.11	32900 7400	16000 3600	2.05		144000 32400	435	432
44.450 1.7500	95.250 3.7500	27.783 1.0938	130000 29200	0.33	1.82	33600 7560	19000 4270	1.77		161000 36200	33885	33821
44.450 1.7500	95.250 3.7500	27.783 1.0938	127000 28500	0.28	2.11	32900 7400	16000 3600	2.05		144000 32400	438	432A
44.450 1.7500	95.250 3.7500	27.783 1.0938	130000 29200	0.33	1.82	33600 7560	19000 4270	1.77		161000 36200	33885	33822
44.450 1.7500	95.250 3.7500	30.162 1.1875	147000 33100	0.55	1.10	38200 8590	35700 8030	1.07		157000 35400	HM804843	HM804810
44.450 1.7500	95.250 3.7500	30.162 1.1875	147000 33100	0.55	1.10	38200 8590	35700 8030	1.07		157000 35400	HM804842	HM804811
44.450 1.7500	95.250 3.7500	30.162 1.1875	122000 27500	0.34	1.77	31700 7120	18300 4120	1.73		153000 34300	3782	3726
44.450 1.7500	95.250 3.7500	30.162 1.1875	147000 33100	0.55	1.10	38200 8590	35700 8030	1.07		157000 35400	HM804842	HM804810
44.450 1.7500	95.250 3.7500	30.958 1.2188	119000 26700	0.74	0.81	30800 6920	39000 8760	0.79		104000 23400	53176	53375
44.450 1.7500	95.250 3.7500	30.958 1.2188	119000 26700	0.74	0.81	30800 6920	39000 8760	0.79		104000 23400	53178	53375
44.450 1.7500	95.250 3.7500	30.958 1.2188	119000 26700	0.74	0.81	30800 6920	39000 8760	0.79		104000 23400	53177	53375
44.450 1.7500	95.250 3.7500	30.958 1.2188	136000 30700	0.74	0.81	35400 7950	44800 10100	0.79		132000 29700	HM903249	HM903210
44.450 1.7500	95.250 3.7500	30.958 1.2188	119000 26700	0.74	0.81	30800 6920	39000 8760	0.79		104000 23400	53176	53377

<sup>(1)</sup>Based on 1 x 10<sup>6</sup> revolutions L<sub>10</sub> life, for the ISO life-calculation method.

<sup>(2)</sup>Consult your Timken engineer for instructions on use or review the Timken Engineering Manual on timken.com/catalogs.

<sup>(3)</sup>Based on 90 x 10<sup>6</sup> revolutions L<sub>10</sub> life, for The Timken Company life-calculation method. C<sub>90</sub> and C<sub>a90</sub> are radial and thrust values.

Bearing Dimensions											Geometry Factors			Bearing Weight
Width B	Width C	Eff. Ctr. a <sup>(4)</sup>	Shaft			Housing			Cage		G <sub>1</sub>	G <sub>2</sub>	C <sub>g</sub>	
			Max Shaft Fillet Radius R <sup>(5)</sup>	Backing Shoulder Dia. d <sub>a</sub>	Shoulder Dia. d <sub>b</sub>	Max Housing Fillet Radius r <sup>(5)</sup>	Backing Shoulder Dia. D <sub>a</sub>	Shoulder Dia. D <sub>b</sub>	A <sub>a</sub> <sup>(6)</sup>	A <sub>b</sub> <sup>(7)</sup>				
mm in.	mm in.	mm in.	mm in.	mm in.	mm in.	mm in.	mm in.	mm in.	mm in.	mm in.				kg lbs.
31.750 1.2500	25.400 1.0000	-9.1 -0.36	0.8 0.03	53.0 2.09	54.0 2.13	3.3 0.13	87.0 3.43	82.0 3.23	2.9 0.11	0.8 0.04	42.4	13.6	0.0872	0.99 2.16
31.750 1.2500	26.195 1.0313	-7.9 -0.31	0.8 0.03	54.0 2.13	55.0 2.17	3.3 0.13	87.0 3.43	79.0 3.11	2.1 0.08	1.1 0.05	44.4	13.6	0.0920	1.03 2.25
31.750 1.2500	26.195 1.0313	-7.9 -0.31	3.5 0.14	54.0 2.13	60.0 2.36	3.3 0.13	87.0 3.43	79.0 3.11	2.1 0.08	1.1 0.05	44.4	13.6	0.0920	1.02 2.24
29.900 1.1772	22.225 0.8750	-9.1 -0.36	3.5 0.14	51.0 2.01	57.0 2.24	2.3 0.09	87.0 3.43	83.0 3.27	1.6 0.06	0.5 0.02	42.5	11.3	0.0805	0.93 2.06
29.900 1.1772	22.225 0.8750	-9.1 -0.36	0.8 0.03	51.0 2.01	52.0 2.05	2.3 0.09	87.0 3.43	83.0 3.27	1.6 0.06	0.5 0.02	42.5	11.3	0.0805	0.94 2.07
28.575 1.1250	22.225 0.8750	-7.6 -0.30	0.8 0.03	53.0 2.09	53.0 2.09	2.3 0.09	90.0 3.54	85.0 3.35	1.3 0.05	2.2 0.09	52.5	18.5	0.0910	0.96 2.12
29.900 1.1772	22.225 0.8750	-9.1 -0.36	3.5 0.14	51.0 2.01	57.0 2.24	0.8 0.03	87.0 3.43	84.0 3.31	1.6 0.06	0.5 0.02	42.5	11.3	0.0805	0.93 2.07
28.575 1.1250	22.225 0.8750	-7.6 -0.30	0.8 0.03	53.0 2.09	53.0 2.09	0.8 0.03	90.0 3.54	86.0 3.39	1.3 0.05	2.2 0.09	52.5	18.5	0.0910	0.97 2.13
29.370 1.1563	23.020 0.9063	-3.8 -0.15	3.5 0.14	57.0 2.24	63.0 2.48	3.3 0.13	91.0 3.58	81.0 3.19	2.2 0.09	2.8 0.11	44.8	13.8	0.1017	1.02 2.25
29.370 1.1563	23.020 0.9063	-3.8 -0.15	0.8 0.03	57.0 2.24	57.0 2.24	0.8 0.03	91.0 3.58	83.0 3.27	2.2 0.09	2.8 0.11	44.8	13.8	0.1017	1.04 2.28
30.302 1.1930	23.812 0.9375	-8.1 -0.32	3.5 0.14	52.0 2.05	58.0 2.28	3.3 0.13	88.9 3.50	83.1 3.27	1.8 0.07	1.0 0.04	49.9	14.5	0.0903	1.02 2.23
29.370 1.1563	23.020 0.9063	-3.8 -0.15	0.8 0.03	57.0 2.24	57.0 2.24	3.3 0.13	91.0 3.58	81.0 3.19	2.2 0.09	2.8 0.11	44.8	13.8	0.1017	1.03 2.27
28.300 1.1142	20.638 0.8125	-0.3 -0.01	1.3 0.05	52.7 2.07	59.0 2.32	0.8 0.03	89.0 3.50	81.0 3.19	5.7 0.22	2.2 0.09	26.7	9.6	0.0930	0.92 2.05
28.300 1.1142	20.638 0.8125	-0.3 -0.01	2.0 0.08	52.7 2.07	60.0 2.36	0.8 0.03	89.0 3.50	81.0 3.19	5.7 0.22	2.2 0.09	26.7	9.6	0.0930	0.92 2.05
28.300 1.1142	20.638 0.8125	-0.3 -0.01	3.5 0.14	52.7 2.07	63.0 2.48	0.8 0.03	89.0 3.50	81.0 3.19	5.7 0.22	2.2 0.09	26.7	9.6	0.0930	0.92 2.04
28.575 1.1250	22.225 0.8750	0.5 0.02	3.5 0.14	54.0 2.13	65.0 2.56	0.8 0.03	91.0 3.58	81.0 3.19	3.9 0.15	2.1 0.08	33.7	12.4	0.1010	0.99 2.19
28.300 1.1142	20.638 0.8125	-0.3 -0.01	1.3 0.05	52.7 2.07	59.0 2.32	2.3 0.09	89.0 3.50	80.0 3.15	5.7 0.22	2.2 0.09	26.7	9.6	0.0930	0.92 2.04

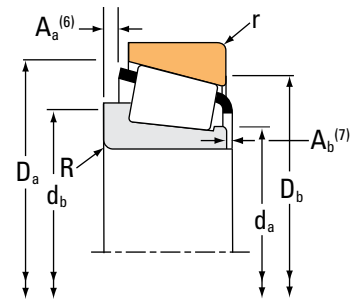
(4) Negative value indicates effective center inside cone (inner-ring) backface.  
 (5) These maximum fillet radii will be cleared by the bearing corners.  
 (6) Negative value indicates cage extends beyond cone (inner-ring) backface.  
 (7) Negative value indicates cage that does not extend beyond cone (inner-ring) front face.

Continued on next page.

# TAPERED ROLLER BEARINGS

## SINGLE-ROW • TYPE TS

### TYPE TS



Bearing Dimensions			Load Ratings							Part Number			
Bore d	O.D. D	Width T	Dynamic <sup>(1)</sup>		Factors <sup>(2)</sup>		Dynamic <sup>(3)</sup>		Factors <sup>(2)</sup>		Static C <sub>0</sub>	Inner	Outer
			C <sub>1</sub>	e	Y	C <sub>90</sub>	C <sub>a90</sub>	K	N	N			
mm in.	mm in.	mm in.	N lbf			N lbf	N lbf		N lbf				
44.450 1.7500	95.250 3.7500	30.958 1.2188	136000 30700	0.74	0.81	35400 7950	44800 10100	0.79	132000 29700			HM903247	HM903210
44.450 1.7500	95.250 3.7500	30.958 1.2188	136000 30700	0.74	0.81	35400 7950	44800 10100	0.79	132000 29700			HM903249A	HM903210
44.450 1.7500	96.838 3.8125	21.000 0.8268	98600 22200	0.35	1.69	25500 5740	15500 3480	1.65	107000 24100			386AS	382A
44.450 1.7500	98.425 3.8750	30.162 1.1875	122000 27500	0.34	1.77	31700 7120	18300 4120	1.73	153000 34300			3782	3732
44.450 1.7500	98.425 3.8750	30.958 1.2188	119000 26700	0.74	0.81	30800 6920	39000 8760	0.79	104000 23400			53176	53387
44.450 1.7500	98.425 3.8750	30.958 1.2188	119000 26700	0.74	0.81	30800 6920	39000 8760	0.79	104000 23400			53177	53387
44.450 1.7500	98.425 3.8750	30.958 1.2188	119000 26700	0.74	0.81	30800 6920	39000 8760	0.79	104000 23400			53177	53387X
44.450 1.7500	98.425 3.8750	30.958 1.2188	136000 30700	0.74	0.81	35400 7950	44800 10100	0.79	132000 29700			HM903247	HM903216
44.450 1.7500	98.425 3.8750	30.958 1.2188	136000 30700	0.74	0.81	35400 7950	44800 10100	0.79	132000 29700			HM903249A	HM903216
44.450 1.7500	98.425 3.8750	30.958 1.2188	136000 30700	0.74	0.81	35400 7950	44800 10100	0.79	132000 29700			HM903249	HM903216
44.450 1.7500	98.425 3.8750	30.958 1.2188	119000 26700	0.74	0.81	30800 6920	39000 8760	0.79	104000 23400			53176	53387X
44.450 1.7500	101.600 4.0000	30.958 1.2188	119000 26700	0.74	0.81	30800 6920	39000 8760	0.79	104000 23400			53177	53398
44.450 1.7500	101.600 4.0000	30.958 1.2188	119000 26700	0.74	0.81	30800 6920	39000 8760	0.79	104000 23400			53176	53398
44.450 1.7500	101.600 4.0000	31.750 1.2500	133000 29800	0.40	1.50	34400 7740	23600 5310	1.46	155000 35000			49577	49520
44.450 1.7500	101.600 4.0000	31.750 1.2500	157000 35400	0.40	1.50	40800 9170	28000 6290	1.46	155000 35000			49576	49520
44.450 1.7500	101.600 4.0000	34.925 1.3750	165000 37000	0.29	2.10	42700 9600	20800 4690	2.05	191000 43000			527	522
44.450 1.7500	103.188 4.0625	43.658 1.7188	212000 47700	0.30	2.02	55000 12400	27900 6280	1.97	267000 60100			5356	5335

<sup>(1)</sup>Based on 1 x 10<sup>6</sup> revolutions L<sub>10</sub> life, for the ISO life-calculation method.

<sup>(2)</sup>Consult your Timken engineer for instructions on use or review the Timken Engineering Manual on timken.com/catalogs.

<sup>(3)</sup>Based on 90 x 10<sup>6</sup> revolutions L<sub>10</sub> life, for The Timken Company life-calculation method. C<sub>90</sub> and C<sub>a90</sub> are radial and thrust values.



Bearing Dimensions											Geometry Factors			Bearing Weight
Width B	Width C	Eff. Ctr. a <sup>(4)</sup>	Shaft			Housing			Cage		G <sub>1</sub>	G <sub>2</sub>	C <sub>g</sub>	
			Max Shaft Fillet Radius R <sup>(5)</sup>	Backing Shoulder Dia. d <sub>a</sub>	Backing Shoulder Dia. d <sub>b</sub>	Max Housing Fillet Radius r <sup>(5)</sup>	Backing Shoulder Dia. D <sub>a</sub>	Backing Shoulder Dia. D <sub>b</sub>	A <sub>a</sub> <sup>(6)</sup>	A <sub>b</sub> <sup>(7)</sup>				
mm in.	mm in.	mm in.	mm in.	mm in.	mm in.	mm in.	mm in.	mm in.	mm in.	mm in.				kg lbs.
28.300 1.1142	22.225 0.8750	0.5 0.02	1.3 0.05	54.0 2.13	61.0 2.40	0.8 0.03	91.0 3.58	81.0 3.19	3.9 0.15	2.3 0.09	33.7	12.4	0.1010	0.99 2.20
28.300 1.1142	22.225 0.8750	0.5 0.02	3.5 0.14	54.0 2.13	65.0 2.56	0.8 0.03	91.0 3.58	81.0 3.19	3.9 0.15	2.3 0.09	33.7	12.4	0.1010	0.99 2.19
21.946 0.8640	15.875 0.6250	-3.0 -0.12	3.5 0.14	53.0 2.09	59.0 2.32	0.8 0.03	92.0 3.62	89.0 3.50	1.1 0.04	2.0 0.08	42.0	15.7	0.0859	0.76 1.68
30.302 1.1930	23.812 0.9375	-8.1 -0.32	3.5 0.14	52.0 2.05	58.0 2.28	3.3 0.13	89.9 3.54	84.1 3.31	1.8 0.07	1.0 0.04	49.9	14.5	0.0903	1.11 2.42
28.300 1.1142	20.638 0.8125	-0.3 -0.01	1.3 0.05	52.7 2.07	59.0 2.32	0.8 0.03	91.0 3.58	82.0 3.23	5.7 0.22	2.2 0.09	26.7	9.6	0.0930	1.00 2.22
28.300 1.1142	20.638 0.8125	-0.3 -0.01	3.5 0.14	52.7 2.07	63.0 2.48	0.8 0.03	91.0 3.58	82.0 3.23	5.7 0.22	2.2 0.09	26.7	9.6	0.0930	1.00 2.21
28.300 1.1142	20.638 0.8125	-0.3 -0.01	3.5 0.14	52.7 2.07	63.0 2.48	1.5 0.06	91.0 3.58	82.0 3.23	5.7 0.22	2.2 0.09	26.7	9.6	0.0930	1.00 2.20
28.300 1.1142	22.225 0.8750	0.5 0.02	1.3 0.05	54.0 2.13	61.0 2.40	0.8 0.03	92.0 3.62	82.0 3.23	3.9 0.15	2.3 0.09	33.7	12.4	0.1010	1.08 2.38
28.300 1.1142	22.225 0.8750	0.5 0.02	3.5 0.14	54.0 2.13	65.0 2.56	0.8 0.03	92.0 3.62	82.0 3.23	3.9 0.15	2.3 0.09	33.7	12.4	0.1010	1.08 2.37
28.575 1.1250	22.225 0.8750	0.5 0.02	3.5 0.14	54.0 2.13	65.0 2.56	0.8 0.03	92.0 3.62	82.0 3.23	3.9 0.15	2.1 0.08	33.7	12.4	0.1010	1.08 2.38
28.300 1.1142	20.638 0.8125	-0.3 -0.01	1.3 0.05	52.7 2.07	59.0 2.32	1.5 0.06	91.0 3.58	82.0 3.23	5.7 0.22	2.2 0.09	26.7	9.6	0.0930	1.00 2.22
28.300 1.1142	20.638 0.8125	-0.3 -0.01	3.5 0.14	52.7 2.07	63.0 2.48	0.8 0.03	92.0 3.62	84.0 3.31	5.7 0.22	2.2 0.09	26.7	9.6	0.0930	1.08 2.39
28.300 1.1142	20.638 0.8125	-0.3 -0.01	1.3 0.05	52.7 2.07	59.0 2.32	0.8 0.03	92.0 3.62	84.0 3.31	5.7 0.22	2.2 0.09	26.7	9.6	0.0930	1.08 2.40
31.750 1.2500	25.400 1.0000	-7.1 -0.28	3.5 0.14	54.0 2.13	60.0 2.36	3.3 0.13	96.0 3.78	88.0 3.46	2.3 0.09	1.4 0.06	49.1	16.8	0.0946	1.24 2.73
31.750 1.2500	25.400 1.0000	-7.1 -0.28	0.8 0.03	54.0 2.13	55.0 2.17	3.3 0.13	96.0 3.78	88.0 3.46	2.3 0.09	1.4 0.06	49.1	16.8	0.0946	1.25 2.74
36.068 1.4200	26.988 1.0625	-12.7 -0.50	3.5 0.14	53.0 2.09	59.0 2.32	3.3 0.13	95.0 3.74	89.0 3.50	2.7 0.10	1.8 0.07	57.9	13.4	0.0894	1.37 3.01
44.475 1.7510	36.512 1.4375	-16.0 -0.63	1.3 0.05	56.0 2.20	58.0 2.28	3.3 0.13	97.0 3.82	89.0 3.50	2.5 0.10	1.0 0.04	73.4	15.5	0.0985	1.85 4.07

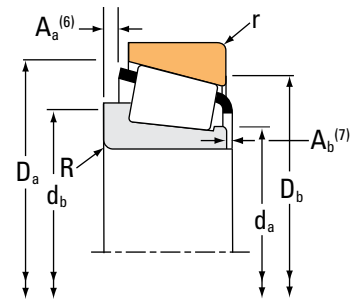
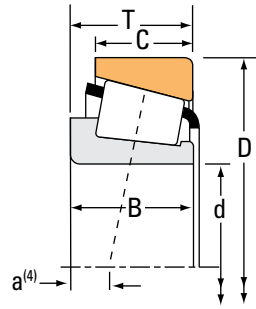
<sup>(4)</sup>Negative value indicates effective center inside cone (inner-ring) backface.  
<sup>(5)</sup>These maximum fillet radii will be cleared by the bearing corners.  
<sup>(6)</sup>Negative value indicates cage extends beyond cone (inner-ring) backface.  
<sup>(7)</sup>Negative value indicates cage that does not extend beyond cone (inner-ring) front face.

Continued on next page.

# TAPERED ROLLER BEARINGS

## SINGLE-ROW • TYPE TS

### TYPE TS



Bearing Dimensions			Load Ratings							Part Number		
Bore d	O.D. D	Width T	Dynamic <sup>(1)</sup>		Factors <sup>(2)</sup>		Dynamic <sup>(3)</sup>		Factors <sup>(2)</sup>	Static	Inner	Outer
			C <sub>1</sub>	e	Y	C <sub>90</sub>	C <sub>a90</sub>	K	C <sub>0</sub>			
mm in.	mm in.	mm in.	N lbf			N lbf	N lbf			N lbf		
44.450 1.7500	104.775 4.1250	30.162 1.1875	153000 34500	0.33	1.80	39700 8930	22600 5090	1.76		189000 42600	45280	45220
44.450 1.7500	104.775 4.1250	30.162 1.1875	161000 36100	0.34	1.79	41700 9370	23900 5380	1.74		166000 37200	460	453X
44.450 1.7500	104.775 4.1250	36.512 1.4375	202000 45500	0.40	1.49	52400 11800	36100 8110	1.45		202000 45400	59175	59412
44.450 1.7500	104.775 4.1250	36.512 1.4375	202000 45500	0.40	1.49	52400 11800	36100 8110	1.45		202000 45400	59176	59413
44.450 1.7500	104.775 4.1250	36.512 1.4375	202000 45500	0.40	1.49	52400 11800	36100 8110	1.45		202000 45400	59175	59413
44.450 1.7500	104.775 4.1250	36.512 1.4375	203000 45700	0.49	1.23	52700 11900	44000 9890	1.20		223000 50200	HM807040	HM807010
44.450 1.7500	104.775 4.1250	36.512 1.4375	202000 45500	0.40	1.49	52400 11800	36100 8110	1.45		202000 45400	59176	59412
44.450 1.7500	105.000 4.1339	36.873 1.4517	203000 45700	0.49	1.23	52700 11900	44000 9890	1.20		223000 50200	HM807040	JHM807012
44.450 1.7500	107.950 4.2500	27.783 1.0938	161000 36100	0.34	1.79	41700 9370	23900 5380	1.74		166000 37200	460	453A
44.450 1.7500	107.950 4.2500	36.512 1.4375	202000 45500	0.40	1.49	52400 11800	36100 8110	1.45		202000 45400	59176	59425
44.450 1.7500	111.125 4.3750	30.162 1.1875	126000 28300	0.88	0.68	32700 7350	49500 11100	0.66		119000 26700	55175	55437
44.450 1.7500	111.125 4.3750	30.162 1.1875	123000 27700	0.88	0.68	31900 7170	48200 10800	0.66		153000 34400	HM907635	HM907614
44.450 1.7500	111.125 4.3750	30.162 1.1875	151000 34000	0.88	0.68	39200 8810	59300 13300	0.66		161000 36200	55176C	55437
44.450 1.7500	111.125 4.3750	30.162 1.1875	151000 34000	0.88	0.68	39200 8810	59300 13300	0.66		161000 36200	55175C	55437
44.450 1.7500	111.125 4.3750	38.100 1.5000	172000 38700	0.30	2.02	44600 10000	22700 5090	1.97		206000 46200	535	532A
44.450 1.7500	112.712 4.4375	30.162 1.1875	126000 28300	0.88	0.68	32700 7350	49500 11100	0.66		119000 26700	55175	55443
44.450 1.7500	112.712 4.4375	30.162 1.1875	123000 27700	0.88	0.68	31900 7170	48200 10800	0.66		153000 34400	HM907635	HM907616

<sup>(1)</sup>Based on 1 x 10<sup>6</sup> revolutions L<sub>10</sub> life, for the ISO life-calculation method.

<sup>(2)</sup>Consult your Timken engineer for instructions on use or review the Timken Engineering Manual on timken.com/catalogs.

<sup>(3)</sup>Based on 90 x 10<sup>6</sup> revolutions L<sub>10</sub> life, for The Timken Company life-calculation method. C<sub>90</sub> and C<sub>a90</sub> are radial and thrust values.

Bearing Dimensions											Geometry Factors			Bearing Weight
Width B	Width C	Eff. Ctr. a <sup>(4)</sup>	Shaft			Housing			Cage		G <sub>1</sub>	G <sub>2</sub>	C <sub>g</sub>	
			Max Shaft Fillet Radius R <sup>(5)</sup>	Backing Shoulder Dia. d <sub>a</sub>	Shoulder Dia. d <sub>b</sub>	Max Housing Fillet Radius r <sup>(5)</sup>	Backing Shoulder Dia. D <sub>a</sub>	Shoulder Dia. D <sub>b</sub>	A <sub>a</sub> <sup>(6)</sup>	A <sub>b</sub> <sup>(7)</sup>				
mm in.	mm in.	mm in.	mm in.	mm in.	mm in.	mm in.	mm in.	mm in.	mm in.	mm in.			kg lbs.	
30.958 1.2188	23.812 0.9375	-8.1 -0.32	0.8 0.03	54.0 2.13	55.0 2.17	3.3 0.13	99.0 3.90	93.0 3.66	2.1 0.08	1.8 0.07	63.5	16.9	0.0971	1.34 2.93
29.317 1.1542	24.605 0.9687	-7.1 -0.28	3.5 0.14	54.0 2.13	60.0 2.36	3.3 0.13	98.0 3.86	92.0 3.62	2.1 0.08	1.4 0.06	58.6	17.1	0.0946	1.28 2.81
36.512 1.4375	28.575 1.1250	-9.7 -0.38	3.5 0.14	56.0 2.20	63.0 2.48	3.3 0.13	99.0 3.90	92.0 3.62	3.4 0.13	1.3 0.05	57.3	15.2	0.0999	1.54 3.39
36.512 1.4375	28.575 1.1250	-9.7 -0.38	0.8 0.03	56.0 2.20	57.0 2.24	0.8 0.03	102.0 4.02	87.0 3.43	3.4 0.13	1.3 0.05	57.3	15.2	0.0999	1.56 3.44
36.512 1.4375	28.575 1.1250	-9.7 -0.38	3.5 0.14	56.0 2.20	63.0 2.48	0.8 0.03	102.0 4.02	87.0 3.43	3.4 0.13	1.3 0.05	57.3	15.2	0.0999	1.55 3.42
36.512 1.4375	28.575 1.1250	-7.4 -0.29	3.5 0.14	59.0 2.32	66.0 2.60	3.3 0.13	100.0 3.94	89.0 3.50	3.4 0.13	2.0 0.08	63.9	17.1	0.0760	1.60 3.52
36.512 1.4375	28.575 1.1250	-9.7 -0.38	0.8 0.03	56.0 2.20	57.0 2.24	3.3 0.13	99.0 3.90	92.0 3.62	3.4 0.13	1.3 0.05	57.3	15.2	0.0999	1.55 3.41
36.512 1.4375	29.000 1.1417	-7.4 -0.29	3.5 0.14	59.0 2.32	66.0 2.60	2.5 0.10	100.0 3.94	90.0 3.54	3.4 0.13	2.0 0.08	63.9	17.1	0.0760	1.62 3.55
29.317 1.1542	22.225 0.8750	-7.1 -0.28	3.5 0.14	54.0 2.13	60.0 2.36	0.8 0.03	100.0 3.94	97.0 3.82	2.1 0.08	1.4 0.06	58.6	17.1	0.0946	1.33 2.93
36.512 1.4375	28.575 1.1250	-9.7 -0.38	0.8 0.03	56.0 2.20	57.0 2.24	3.3 0.13	101.0 3.98	93.0 3.66	3.4 0.13	1.3 0.05	57.3	15.2	0.0999	1.66 3.67
26.909 1.0594	20.638 0.8125	7.1 0.28	3.5 0.14	60.0 2.36	67.0 2.64	3.3 0.13	105.0 4.13	92.0 3.62	4.8 0.18	3.2 0.13	36.8	13.2	0.1085	1.36 3.02
28.575 1.1250	20.638 0.8125	7.6 0.30	0.8 0.03	65.3 2.56	64.0 2.52	3.3 0.13	105.0 4.13	91.0 3.58	4.6 0.18	2.1 0.08	46.9	17.5	0.1182	1.46 3.21
26.909 1.0594	20.638 0.8125	7.6 0.30	0.8 0.03	65.0 2.56	71.0 2.80	3.3 0.13	105.0 4.13	92.0 3.62	5.0 0.19	3.7 0.15	48.7	18.1	0.1198	1.46 3.20
26.909 1.0594	20.638 0.8125	7.6 0.30	3.5 0.14	64.0 2.52	70.0 2.76	3.3 0.13	105.0 4.13	92.0 3.62	5.0 0.19	3.7 0.15	48.7	18.1	0.1198	1.46 3.20
36.957 1.4550	30.162 1.1875	-12.2 -0.48	3.5 0.14	54.0 2.13	60.0 2.36	3.3 0.13	100.0 3.94	95.0 3.74	2.7 0.10	1.0 0.04	64.3	16.1	0.0938	1.84 4.04
26.909 1.0594	20.638 0.8125	7.1 0.28	3.5 0.14	60.0 2.36	67.0 2.64	3.3 0.13	106.0 4.17	92.0 3.62	4.8 0.18	3.2 0.13	36.8	13.2	0.1085	1.39 3.09
28.575 1.1250	20.638 0.8125	7.6 0.30	0.8 0.03	65.3 2.56	64.0 2.52	3.3 0.13	106.0 4.17	91.0 3.58	4.6 0.18	2.1 0.08	46.9	17.5	0.1182	1.52 3.35

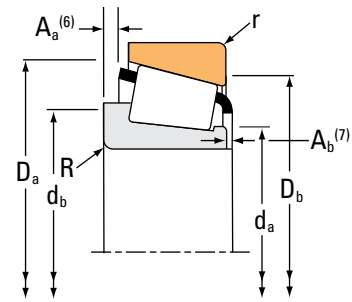
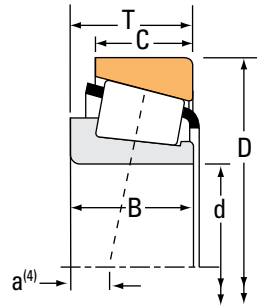
(4) Negative value indicates effective center inside cone (inner-ring) backface.  
 (5) These maximum fillet radii will be cleared by the bearing corners.  
 (6) Negative value indicates cage extends beyond cone (inner-ring) backface.  
 (7) Negative value indicates cage that does not extend beyond cone (inner-ring) front face.

Continued on next page.

# TAPERED ROLLER BEARINGS

## SINGLE-ROW • TYPE TS

### TYPE TS



Bearing Dimensions			Load Ratings							Part Number			
Bore d	O.D. D	Width T	Dynamic <sup>(1)</sup>		Factors <sup>(2)</sup>		Dynamic <sup>(3)</sup>		Factors <sup>(2)</sup>		Static C <sub>0</sub>	Inner	Outer
			C <sub>1</sub>	e	Y	C <sub>90</sub>	C <sub>a90</sub>	K	N	N			
mm in.	mm in.	mm in.	N lbf			N lbf	N lbf		N lbf				
44.450 1.7500	112.712 4.4375	30.162 1.1875	151000 34000	0.88	0.68	39200 8810	59300 13300	0.66	161000 36200			55176C	55443
44.450 1.7500	114.300 4.5000	44.450 1.7500	224000 50300	0.43	1.39	58000 13000	42700 9600	1.36	256000 57500			65385	65320
44.450 1.7500	114.300 4.5000	44.450 1.7500	224000 50300	0.43	1.39	58000 13000	42700 9600	1.36	256000 57500			65384	65320
44.450 1.7500	120.650 4.7500	41.275 1.6250	207000 46600	0.31	1.91	53800 12100	28900 6510	1.86	244000 54800			615	612
44.450 1.7500	127.000 5.0000	50.800 2.0000	306000 68800	0.30	2.01	79300 17800	40500 9110	1.96	370000 83300			6277	6220
44.983 1.7710	82.931 3.2650	23.812 0.9375	90500 20300	0.33	1.79	23500 5270	13500 3020	1.74	111000 24900			25584	25520
44.983 1.7710	82.931 3.2650	26.988 1.0625	90500 20300	0.33	1.79	23500 5270	13500 3020	1.74	111000 24900			25584	25523
44.983 1.7710	83.058 3.2700	23.812 0.9375	90500 20300	0.33	1.79	23500 5270	13500 3020	1.74	111000 24900			25584	25521
44.983 1.7710	84.988 3.3460	18.999 0.7480	62400 14000	0.44	1.35	16200 3640	12300 2770	1.31	69200 15600			29177	29334
44.983 1.7710	85.000 3.3465	23.812 0.9375	90500 20300	0.33	1.79	23500 5270	13500 3020	1.74	111000 24900			25584	25526
44.983 1.7710	93.264 3.6718	30.162 1.1875	122000 27500	0.34	1.77	31700 7120	18300 4120	1.73	153000 34300			3776	3720
44.987 1.7712	81.973 3.2273	23.876 0.9400	90500 20300	0.33	1.79	23500 5270	13500 3020	1.74	111000 24900			25584A	25518
44.987 1.7712	82.931 3.2650	23.812 0.9375	90500 20300	0.33	1.79	23500 5270	13500 3020	1.74	111000 24900			25584A	25520
44.987 1.7712	90.000 3.5433	25.000 0.9843	85900 19300	0.32	1.88	22300 5010	12200 2740	1.83	95800 21500			367X	362X
44.987 1.7712	95.250 3.7500	30.958 1.2188	115000 25900	0.74	0.81	29800 6710	37800 8490	0.79	132000 29700			HM903248	HM903210
45.000 1.7717	85.000 3.3465	20.638 0.8125	97000 21800	0.31	1.96	25100 5650	13200 2960	1.91	88800 20000			358	354A
45.000 1.7717	85.000 3.3465	20.638 0.8125	81800 18400	0.31	1.96	21200 4770	11100 2500	1.91	88800 20000			358A	354A

<sup>(1)</sup>Based on  $1 \times 10^6$  revolutions  $L_{10}$  life, for the ISO life-calculation method.

<sup>(2)</sup>Consult your Timken engineer for instructions on use or review the Timken Engineering Manual on [timken.com/catalogs](http://timken.com/catalogs).

<sup>(3)</sup>Based on  $90 \times 10^6$  revolutions  $L_{10}$  life, for The Timken Company life-calculation method.  $C_{90}$  and  $C_{a90}$  are radial and thrust values.

Bearing Dimensions											Geometry Factors			Bearing Weight
Width B	Width C	Eff. Ctr. a <sup>(4)</sup>	Shaft			Housing			Cage		G <sub>1</sub>	G <sub>2</sub>	C <sub>g</sub>	
			Max Shaft Fillet Radius R <sup>(5)</sup>	Backing Shoulder Dia. d <sub>a</sub> d <sub>b</sub>		Max Housing Fillet Radius r <sup>(5)</sup>	Backing Shoulder Dia. D <sub>a</sub> D <sub>b</sub>		A <sub>a</sub> <sup>(6)</sup>	A <sub>b</sub> <sup>(7)</sup>				
mm in.	mm in.	mm in.	mm in.	mm in.	mm in.	mm in.	mm in.	mm in.	mm in.	mm in.				kg lbs.
26.909 1.0594	20.638 0.8125	7.6 0.30	0.8 0.03	65.0 2.56	71.0 2.80	3.3 0.13	106.0 4.17	92.0 3.62	5.0 0.19	3.7 0.15	48.7	18.1	0.1198	1.49 3.28
44.450 1.7500	34.925 1.3750	-12.4 -0.49	3.5 0.14	60.0 2.36	67.0 2.64	3.3 0.13	107.0 4.21	97.0 3.82	3.6 0.14	1.1 0.05	63.1	13.0	0.1053	2.31 5.09
44.450 1.7500	34.925 1.3750	-12.4 -0.49	2.0 0.08	60.0 2.36	64.0 2.52	3.3 0.13	107.0 4.21	97.0 3.82	3.6 0.14	1.1 0.05	63.1	13.0	0.1053	2.32 5.10
41.275 1.6250	31.750 1.2500	-14.0 -0.55	3.5 0.14	56.0 2.20	62.0 2.44	3.3 0.13	110.0 4.33	105.0 4.13	3.8 0.15	1.9 0.08	75.9	16.2	0.0694	2.42 5.34
52.388 2.0625	41.275 1.6250	-19.6 -0.77	3.5 0.14	60.0 2.36	67.0 2.64	3.3 0.13	117.0 4.61	108.0 4.25	2.3 0.09	2.6 0.11	103.1	18.7	0.0757	3.57 7.85
25.400 1.0000	19.050 0.7500	-6.4 -0.25	1.5 0.06	51.0 2.01	53.0 2.09	0.8 0.03	77.0 3.03	74.0 2.91	1.0 0.04	0.7 0.03	35.2	14.3	0.0801	0.56 1.22
25.400 1.0000	22.225 0.8750	-6.4 -0.25	1.5 0.06	51.0 2.01	53.0 2.09	2.3 0.09	77.0 3.03	72.0 2.83	1.0 0.04	0.7 0.03	35.2	14.3	0.0801	0.60 1.31
25.400 1.0000	19.050 0.7500	-6.4 -0.25	1.5 0.06	51.0 2.01	53.0 2.09	3.3 0.13	77.0 3.03	72.0 2.83	1.0 0.04	0.7 0.03	35.2	14.3	0.0801	0.55 1.20
19.164 0.7545	15.875 0.6250	-1.3 -0.05	2.0 0.08	50.0 1.97	54.0 2.13	1.5 0.06	78.0 3.07	74.0 2.91	* *	* *	23.8	15.3	0.0766	0.46 1.01
25.400 1.0000	19.050 0.7500	-6.4 -0.25	1.5 0.06	51.0 2.01	53.0 2.09	2.3 0.09	78.0 3.07	74.0 2.91	1.0 0.04	0.7 0.03	35.2	14.3	0.0801	0.60 1.30
30.302 1.1930	23.812 0.9375	-8.1 -0.32	3.5 0.14	53.0 2.09	59.0 2.32	3.3 0.13	87.9 3.46	82.0 3.23	1.8 0.07	1.0 0.04	49.9	14.5	0.0903	0.96 2.10
25.400 1.0000	19.114 0.7525	-6.4 -0.25	3.5 0.14	51.0 2.01	57.0 2.24	1.0 0.04	77.0 3.03	74.0 2.91	1.0 0.04	0.7 0.03	35.2	14.3	0.0801	0.53 1.17
25.400 1.0000	19.050 0.7500	-6.4 -0.25	3.5 0.14	51.0 2.01	57.0 2.24	0.8 0.03	77.0 3.03	74.0 2.91	1.0 0.04	0.7 0.03	35.2	14.3	0.0801	0.55 1.21
22.225 0.8750	20.000 0.7874	-4.3 -0.17	1.5 0.06	51.0 2.01	54.0 2.13	2.0 0.08	84.0 3.31	80.0 3.15	0.4 0.01	1.1 0.04	33.8	14.0	0.0773	0.67 1.47
28.575 1.1250	22.225 0.8750	0.5 0.02	3.5 0.14	54.0 2.13	66.0 2.60	0.8 0.03	91.0 3.58	81.0 3.19	* *	* *	33.7	12.4	0.1010	0.98 2.18
21.692 0.8540	17.462 0.6875	-4.8 -0.19	1.5 0.06	50.0 1.97	53.0 2.09	1.3 0.05	80.0 3.15	77.0 3.03	0.4 0.01	1.7 0.07	30.0	12.2	0.0732	0.50 1.11
21.692 0.8540	17.462 0.6875	-4.8 -0.19	3.5 0.14	50.0 1.97	57.0 2.24	1.3 0.05	80.0 3.15	77.0 3.03	0.4 0.01	1.7 0.07	30.0	12.2	0.0732	0.50 1.10

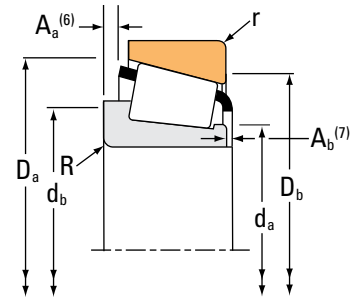
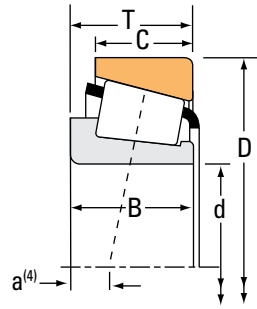
(4) Negative value indicates effective center inside cone (inner-ring) backface.  
 (5) These maximum fillet radii will be cleared by the bearing corners.  
 (6) Negative value indicates cage extends beyond cone (inner-ring) backface.  
 (7) Negative value indicates cage that does not extend beyond cone (inner-ring) front face.  
 (\*) Contact your Timken engineer for details.

Continued on next page.

# TAPERED ROLLER BEARINGS

## SINGLE-ROW • TYPE TS

### TYPE TS



Bearing Dimensions			Load Ratings							Part Number		
Bore d	O.D. D	Width T	Dynamic <sup>(1)</sup>		Factors <sup>(2)</sup>		Dynamic <sup>(3)</sup>		Factors <sup>(2)</sup>	Static	Inner	Outer
			C <sub>1</sub>	e	Y	C <sub>90</sub>	C <sub>a90</sub>	K	C <sub>0</sub>			
mm in.	mm in.	mm in.	N lbf			N lbf	N lbf			N lbf		
45.000 1.7717	85.000 3.3465	20.638 0.8125	97000 21800	0.31	1.96	25100 5650	13200 2960	1.91	88800 20000	358	354X	
45.000 1.7717	85.000 3.3465	20.638 0.8125	81800 18400	0.31	1.96	21200 4770	11100 2500	1.91	88800 20000	358X	354X	
45.000 1.7717	87.312 3.4375	26.988 1.0625	97000 21800	0.31	1.96	25100 5650	13200 2960	1.91	88800 20000	358	3525	
45.000 1.7717	88.900 3.5000	20.638 0.8125	102000 22900	0.32	1.88	26400 5930	14400 3250	1.83	95800 21500	367	362A	
45.000 1.7717	89.980 3.5425	24.750 0.9744	117000 26400	0.38	1.59	30400 6830	19600 4410	1.55	130000 29200	J28577	28520	
45.000 1.7717	90.000 3.5433	20.000 0.7874	102000 22900	0.32	1.88	26400 5930	14400 3250	1.83	95800 21500	367	362	
45.000 1.7717	90.000 3.5433	27.783 1.0938	127000 28500	0.28	2.11	32900 7400	16000 3600	2.05	144000 32400	435-S	430X	
45.000 1.7717	90.119 3.5480	23.000 0.9055	97000 21800	0.31	1.96	25100 5650	13200 2960	1.91	88800 20000	358	352	
45.000 1.7717	93.264 3.6718	20.638 0.8125	104000 23400	0.34	1.77	27000 6070	15700 3520	1.73	101000 22700	376	374	
45.000 1.7717	95.000 3.7402	29.000 1.1417	99900 22500	0.87	0.69	25900 5820	38400 8630	0.67	114000 25600	JW4549	JW4510	
45.000 1.7717	96.838 3.8125	22.225 0.8750	104000 23400	0.34	1.77	27000 6070	15700 3520	1.73	101000 22700	376	372A	
45.000 1.7717	100.000 3.9370	24.999 0.9842	104000 23400	0.34	1.77	27000 6070	15700 3520	1.73	101000 22700	376	372	
45.000 1.7717	104.775 4.1250	39.688 1.5625	180000 40500	0.34	1.79	46800 10500	26800 6030	1.74	237000 53200	4559	4535	
45.000 1.7717	107.950 4.2500	27.783 1.0938	136000 30500	0.34	1.79	35200 7900	20200 4540	1.74	166000 37200	458-S	453A	
45.230 1.7807	79.985 3.1490	19.842 0.7812	68900 15500	0.37	1.64	17900 4020	11200 2510	1.60	83300 18700	17887	17831	
45.237 1.7810	84.138 3.3125	30.162 1.1875	113000 25500	0.31	1.96	29400 6610	15400 3460	1.91	134000 30100	3586	3520	
45.237 1.7810	87.312 3.4375	30.162 1.1875	113000 25500	0.31	1.96	29400 6610	15400 3460	1.91	134000 30100	3586	3525	

<sup>(1)</sup>Based on  $1 \times 10^6$  revolutions  $L_{10}$  life, for the ISO life-calculation method.

<sup>(2)</sup>Consult your Timken engineer for instructions on use or review the Timken Engineering Manual on [timken.com/catalogs](http://timken.com/catalogs).

<sup>(3)</sup>Based on  $90 \times 10^6$  revolutions  $L_{10}$  life, for The Timken Company life-calculation method.  $C_{90}$  and  $C_{a90}$  are radial and thrust values.

Bearing Dimensions											Geometry Factors			Bearing Weight
Width B	Width C	Eff. Ctr. a <sup>(4)</sup>	Shaft			Housing			Cage		G <sub>1</sub>	G <sub>2</sub>	C <sub>g</sub>	
			Max Shaft Fillet Radius R <sup>(5)</sup>	Backing Shoulder Dia. d <sub>a</sub>	Backing Shoulder Dia. d <sub>b</sub>	Max Housing Fillet Radius r <sup>(5)</sup>	Backing Shoulder Dia. D <sub>a</sub>	Backing Shoulder Dia. D <sub>b</sub>	A <sub>a</sub> <sup>(6)</sup>	A <sub>b</sub> <sup>(7)</sup>				
mm in.	mm in.	mm in.	mm in.	mm in.	mm in.	mm in.	mm in.	mm in.	mm in.	mm in.				kg lbs.
21.692 0.8540	17.462 0.6875	-4.8 -0.19	1.5 0.06	50.0 1.97	53.0 2.09	1.5 0.06	80.0 3.15	77.0 3.03	0.4 0.01	1.7 0.07	30.0	12.2	0.0732	0.50 1.12
21.692 0.8540	17.462 0.6875	-4.8 -0.19	2.0 0.08	50.0 1.97	54.0 2.13	1.5 0.06	80.0 3.15	77.0 3.03	0.4 0.01	1.7 0.07	30.0	12.2	0.0732	0.50 1.11
21.692 0.8540	23.812 0.9375	-4.8 -0.19	1.5 0.06	50.0 1.97	53.0 2.09	3.3 0.13	81.0 3.19	75.0 2.95	0.4 0.01	1.7 0.07	30.0	12.2	0.0732	0.64 1.41
22.225 0.8750	16.513 0.6501	-4.3 -0.17	2.0 0.08	51.0 2.01	55.0 2.17	1.3 0.05	84.0 3.31	81.0 3.19	0.4 0.01	1.1 0.04	33.8	14.0	0.0773	0.59 1.29
25.400 1.0000	19.987 0.7869	-4.8 -0.19	0.8 0.03	57.0 2.24	55.0 2.17	2.3 0.09	86.0 3.39	81.0 3.19	1.4 0.05	1.1 0.05	46.4	18.9	0.0912	0.75 1.64
22.225 0.8750	15.875 0.6250	-4.3 -0.17	2.0 0.08	51.0 2.01	55.0 2.17	2.0 0.08	84.0 3.31	81.0 3.19	0.4 0.01	1.1 0.04	33.8	14.0	0.0773	0.59 1.31
29.900 1.1772	22.225 0.8750	-9.1 -0.36	2.0 0.08	51.0 2.01	55.0 2.17	2.0 0.08	84.0 3.31	81.0 3.19	1.6 0.06	0.5 0.02	42.5	11.3	0.0805	0.80 1.76
21.692 0.8540	21.808 0.8586	-4.8 -0.19	1.5 0.06	50.0 1.97	53.0 2.09	2.3 0.09	82.0 3.23	78.0 3.07	0.4 0.01	1.7 0.07	30.0	12.2	0.0732	0.66 1.46
22.225 0.8750	15.083 0.5938	-3.8 -0.15	0.8 0.03	52.0 2.05	53.0 2.09	1.3 0.05	88.0 3.46	85.0 3.35	0.8 0.03	1.5 0.06	37.6	15.4	0.0816	0.67 1.48
26.500 1.0433	20.000 0.7874	4.0 0.16	2.5 0.10	54.0 2.13	64.0 2.52	2.5 0.10	90.0 3.56	78.0 3.07	4.6 0.18	3.1 0.12	30.7	12.9	0.1021	0.90 2.00
22.225 0.8750	19.050 0.7500	-3.8 -0.15	0.8 0.03	52.0 2.05	53.0 2.09	1.5 0.06	90.0 3.54	86.0 3.39	0.8 0.03	1.5 0.06	37.6	15.4	0.0816	0.79 1.75
22.225 0.8750	21.824 0.8592	-3.8 -0.15	0.8 0.03	52.0 2.05	53.0 2.09	2.0 0.08	90.0 3.54	86.0 3.39	0.8 0.03	1.5 0.06	37.6	15.4	0.0816	0.93 2.05
40.157 1.5810	33.338 1.3125	-12.4 -0.49	3.5 0.14	56.0 2.20	62.0 2.44	3.3 0.13	99.0 3.90	90.0 3.54	1.6 0.06	1.3 0.05	73.6	20.2	0.1027	1.76 3.88
29.317 1.1542	22.225 0.8750	-7.1 -0.28	2.3 0.09	55.0 2.17	58.0 2.28	0.8 0.03	100.0 3.94	97.0 3.82	2.1 0.08	1.4 0.06	58.6	17.1	0.0946	1.33 2.92
20.638 0.8125	15.080 0.5937	-3.8 -0.15	2.0 0.08	50.0 1.97	54.0 2.13	1.3 0.05	75.0 2.95	72.0 2.83	1.1 0.04	1.3 0.06	28.9	17.9	0.0770	0.39 0.88
30.886 1.2160	23.812 0.9375	-10.2 -0.40	3.5 0.14	52.0 2.05	58.0 2.28	3.3 0.13	79.5 3.13	74.0 2.91	2.2 0.09	0.7 0.03	39.5	12.5	0.0808	0.68 1.48
30.886 1.2160	23.812 0.9375	-10.2 -0.40	3.5 0.14	52.0 2.05	58.0 2.28	3.3 0.13	81.0 3.19	75.0 2.95	2.2 0.09	0.7 0.03	39.5	12.5	0.0808	0.76 1.65

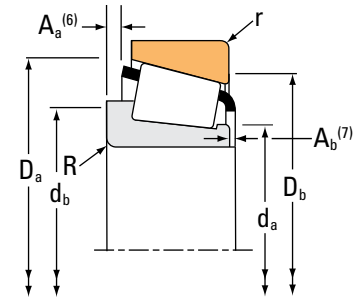
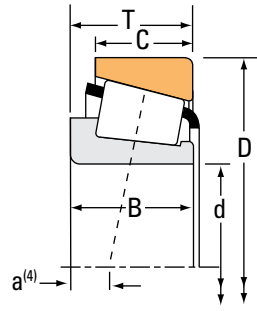
(4) Negative value indicates effective center inside cone (inner-ring) backface.  
 (5) These maximum fillet radii will be cleared by the bearing corners.  
 (6) Negative value indicates cage extends beyond cone (inner-ring) backface.  
 (7) Negative value indicates cage that does not extend beyond cone (inner-ring) front face.

Continued on next page.

# TAPERED ROLLER BEARINGS

## SINGLE-ROW • TYPE TS

### TYPE TS



Bearing Dimensions			Load Ratings							Part Number			
Bore d	O.D. D	Width T	Dynamic <sup>(1)</sup>		Factors <sup>(2)</sup>		Dynamic <sup>(3)</sup>		Factors <sup>(2)</sup>		Static C <sub>0</sub>	Inner	Outer
			C <sub>1</sub>	e	Y	C <sub>90</sub>	C <sub>a90</sub>	K	N	N			
mm in.	mm in.	mm in.	N lbf			N lbf	N lbf		N lbf				
45.242 1.7812	73.431 2.8910	19.558 0.7700	72900 16400	0.31	1.97	18900 4250	9870 2220	1.91	81800 18400		LM102949	LM102910	
45.242 1.7812	73.431 2.8910	21.430 0.8437	72900 16400	0.31	1.97	18900 4250	9870 2220	1.91	81800 18400		LM102949	LM102911	
45.242 1.7812	77.788 3.0625	19.842 0.7812	76300 17200	0.43	1.41	19800 4450	14500 3250	1.37	77900 17500		LM603049	LM603011	
45.242 1.7812	77.788 3.0625	19.842 0.7812	76300 17200	0.43	1.41	19800 4450	14500 3250	1.37	77900 17500		LM603049AS	LM603011	
45.242 1.7812	77.788 3.0625	21.430 0.8437	76300 17200	0.43	1.41	19800 4450	14500 3250	1.37	77900 17500		LM603049	LM603012	
45.242 1.7812	79.975 3.1486	19.842 0.7812	76300 17200	0.43	1.41	19800 4450	14500 3250	1.37	77900 17500		LM603049	LM603014	
45.242 1.7812	79.975 3.1486	21.430 0.8437	76300 17200	0.43	1.41	19800 4450	14500 3250	1.37	77900 17500		LM603049	LM603015	
45.618 1.7960	82.931 3.2650	23.812 0.9375	90500 20300	0.33	1.79	23500 5270	13500 3020	1.74	111000 24900		25590	25520	
45.618 1.7960	82.931 3.2650	26.988 1.0625	90500 20300	0.33	1.79	23500 5270	13500 3020	1.74	111000 24900		25590	25523	
45.618 1.7960	83.058 3.2700	23.812 0.9375	90500 20300	0.33	1.79	23500 5270	13500 3020	1.74	111000 24900		25590	25521	
45.618 1.7960	83.058 3.2700	23.876 0.9400	90500 20300	0.33	1.79	23500 5270	13500 3020	1.74	111000 24900		25590	25522	
45.618 1.7960	85.000 3.3465	26.988 1.0625	90500 20300	0.33	1.79	23500 5270	13500 3020	1.74	111000 24900		25590	25527	
45.618 1.7960	92.075 3.6250	23.812 0.9375	90500 20300	0.33	1.79	23500 5270	13500 3020	1.74	111000 24900		25590	25528	
45.987 1.8105	74.975 2.9518	18.000 0.7087	67400 15100	0.40	1.49	17500 3930	12000 2700	1.45	75400 17000		LM503349	LM503310	
45.987 1.8105	74.975 2.9518	18.000 0.7087	67400 15100	0.40	1.49	17500 3930	12000 2700	1.45	75400 17000		LM503349A	LM503310	
45.987 1.8105	90.975 3.5817	32.000 1.2598	170000 38300	0.33	1.80	44200 9930	25200 5660	1.76	172000 38600		HM204049	HM204010	
46.037 1.8125	77.788 3.0625	12.700 0.5000	37300 8390	0.34	1.78	9680 2180	5570 1250	1.74	47200 10600		LL205442	LL205410	

<sup>(1)</sup>Based on  $1 \times 10^6$  revolutions  $L_{10}$  life, for the ISO life-calculation method.

<sup>(2)</sup>Consult your Timken engineer for instructions on use or review the Timken Engineering Manual on [timken.com/catalogs](http://timken.com/catalogs).

<sup>(3)</sup>Based on  $90 \times 10^6$  revolutions  $L_{10}$  life, for The Timken Company life-calculation method.  $C_{90}$  and  $C_{a90}$  are radial and thrust values.



Bearing Dimensions											Geometry Factors			Bearing Weight
Width B	Width C	Eff. Ctr. a <sup>(4)</sup>	Shaft			Housing			Cage		G <sub>1</sub>	G <sub>2</sub>	C <sub>g</sub>	
			Max Shaft Fillet Radius R <sup>(5)</sup>	Backing Shoulder Dia. d <sub>a</sub> d <sub>b</sub>		Max Housing Fillet Radius r <sup>(5)</sup>	Backing Shoulder Dia. D <sub>a</sub> D <sub>b</sub>		A <sub>a</sub> <sup>(6)</sup>	A <sub>b</sub> <sup>(7)</sup>				
mm in.	mm in.	mm in.	mm in.	mm in.	mm in.	mm in.	mm in.	mm in.	mm in.	mm in.				kg lbs.
19.812 0.7800	15.748 0.6200	-4.6 -0.18	3.5 0.14	50.0 1.97	56.0 2.20	0.8 0.03	70.0 2.76	68.0 2.68	0.7 0.02	1.1 0.05	31.1	18.8	0.0744	0.31 0.70
19.812 0.7800	17.620 0.6937	-4.6 -0.18	3.5 0.14	50.0 1.97	56.0 2.20	0.8 0.03	70.0 2.76	67.0 2.64	0.7 0.02	1.1 0.05	31.1	18.8	0.0744	0.33 0.74
19.842 0.7812	15.080 0.5937	-2.3 -0.09	3.5 0.14	52.0 2.05	58.0 2.28	0.8 0.03	74.0 2.91	71.0 2.80	1.3 0.05	1.4 0.06	26.4	14.4	0.0785	0.37 0.81
19.842 0.7812	15.080 0.5937	-2.3 -0.09	0.8 0.03	52.0 2.05	53.0 2.09	0.8 0.03	74.0 2.91	71.0 2.80	1.2 0.05	1.5 0.06	26.4	14.4	0.0785	0.37 0.81
19.842 0.7812	16.667 0.6562	-2.3 -0.09	3.5 0.14	52.0 2.05	58.0 2.28	0.8 0.03	74.0 2.91	70.0 2.76	1.3 0.05	1.4 0.06	26.4	14.4	0.0785	0.39 0.85
19.842 0.7812	15.080 0.5937	-2.3 -0.09	3.5 0.14	52.0 2.05	58.0 2.28	0.8 0.03	75.0 2.95	71.0 2.80	1.3 0.05	1.4 0.06	26.4	14.4	0.0785	0.40 0.88
19.842 0.7812	16.667 0.6562	-2.3 -0.09	3.5 0.14	52.0 2.05	58.0 2.28	0.8 0.03	75.0 2.95	71.0 2.80	1.3 0.05	1.4 0.06	26.4	14.4	0.0785	0.42 0.92
25.400 1.0000	19.050 0.7500	-6.4 -0.25	3.5 0.14	51.0 2.01	58.0 2.28	0.8 0.03	77.0 3.03	74.0 2.91	1.0 0.04	0.7 0.03	35.2	14.3	0.0801	0.54 1.19
25.400 1.0000	22.225 0.8750	-6.4 -0.25	3.5 0.14	51.0 2.01	58.0 2.28	2.3 0.09	77.0 3.03	72.0 2.83	1.0 0.04	0.7 0.03	35.2	14.3	0.0801	0.58 1.28
25.400 1.0000	19.050 0.7500	-6.4 -0.25	3.5 0.14	51.0 2.01	58.0 2.28	3.3 0.13	77.0 3.03	72.0 2.83	1.0 0.04	0.7 0.03	35.2	14.3	0.0801	0.53 1.17
25.400 1.0000	19.114 0.7525	-6.4 -0.25	3.5 0.14	51.0 2.01	58.0 2.28	2.0 0.08	77.0 3.03	73.0 2.87	1.0 0.04	0.7 0.03	35.2	14.3	0.0801	0.54 1.19
25.400 1.0000	22.225 0.8750	-6.4 -0.25	3.5 0.14	51.0 2.01	58.0 2.28	2.3 0.09	78.0 3.07	73.0 2.87	1.0 0.04	0.7 0.03	35.2	14.3	0.0801	0.63 1.39
25.400 1.0000	19.050 0.7500	-6.4 -0.25	3.5 0.14	51.0 2.01	58.0 2.28	0.8 0.03	80.0 3.15	78.0 3.07	1.0 0.04	0.7 0.03	35.2	14.3	0.0801	0.73 1.60
18.000 0.7087	14.000 0.5512	-2.0 -0.08	2.3 0.09	51.0 2.01	55.0 2.17	1.5 0.06	71.0 2.80	67.0 2.64	0.9 0.03	1.5 0.06	28.3	22.5	0.0789	0.30 0.67
18.000 0.7087	14.000 0.5512	-2.0 -0.08	0.0 0.00	51.0 2.01	57.0 2.24	1.5 0.06	71.0 2.80	67.0 2.64	0.9 0.03	1.5 0.06	28.3	22.5	0.0789	0.29 0.65
32.000 1.2598	26.500 1.0433	-9.7 -0.38	3.5 0.14	55.0 2.17	63.0 2.48	3.5 0.14	86.0 3.39	79.0 3.11	1.5 0.06	1.9 0.08	47.7	14.5	0.0885	0.91 2.02
12.700 0.5000	9.525 0.3750	0.0 0.00	1.5 0.06	52.0 2.05	54.0 2.13	1.5 0.06	74.0 2.91	71.0 2.80	0.2 0.00	1.7 0.07	24.2	29.1	0.0699	0.23 0.52

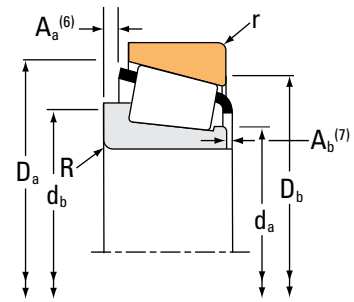
(4) Negative value indicates effective center inside cone (inner-ring) backface.  
 (5) These maximum fillet radii will be cleared by the bearing corners.  
 (6) Negative value indicates cage extends beyond cone (inner-ring) backface.  
 (7) Negative value indicates cage that does not extend beyond cone (inner-ring) front face.

Continued on next page.

# TAPERED ROLLER BEARINGS

## SINGLE-ROW • TYPE TS

### TYPE TS



Bearing Dimensions			Load Ratings						Part Number			
Bore d	O.D. D	Width T	Dynamic <sup>(1)</sup>		Factors <sup>(2)</sup>		Dynamic <sup>(3)</sup>		Static		Inner	Outer
			C <sub>1</sub>	e	Y	C <sub>90</sub>	C <sub>a90</sub>	K	C <sub>0</sub>			
mm in.	mm in.	mm in.	N lbf			N lbf	N lbf		N lbf			
46.037 1.8125	79.375 3.1250	17.462 0.6875	52000 11700	0.37	1.60	13500 3030	8630 1940	1.56	61300 13800		18690	18620
46.037 1.8125	80.962 3.1875	19.050 0.7500	50800 11400	0.53	1.14	13200 2960	11900 2680	1.11	61100 13700		13181	13318
46.037 1.8125	82.931 3.2650	23.812 0.9375	90500 20300	0.33	1.79	23500 5270	13500 3020	1.74	111000 24900		25592	25520
46.037 1.8125	84.138 3.3125	26.995 1.0628	97000 21800	0.31	1.96	25100 5650	13200 2960	1.91	88800 20000		359-S	3520
46.037 1.8125	85.000 3.3465	20.638 0.8125	97000 21800	0.31	1.96	25100 5650	13200 2960	1.91	88800 20000		359A	354A
46.037 1.8125	85.000 3.3465	20.638 0.8125	97000 21800	0.31	1.96	25100 5650	13200 2960	1.91	88800 20000		359-S	354A
46.037 1.8125	85.000 3.3465	20.638 0.8125	97000 21800	0.31	1.96	25100 5650	13200 2960	1.91	88800 20000		359-S	354X
46.037 1.8125	85.000 3.3465	25.400 1.0000	93300 21000	0.35	1.73	24200 5440	14300 3220	1.69	117000 26200		2984	2924
46.037 1.8125	85.000 3.3465	25.400 1.0000	93300 21000	0.35	1.73	24200 5440	14300 3220	1.69	117000 26200		2984A	2924
46.037 1.8125	87.312 3.4375	26.988 1.0625	97000 21800	0.31	1.96	25100 5650	13200 2960	1.91	88800 20000		359-S	3525
46.037 1.8125	87.312 3.4375	26.988 1.0625	93300 21000	0.35	1.73	24200 5440	14300 3220	1.69	117000 26200		2984	2925
46.037 1.8125	88.875 3.4990	23.000 0.9055	97000 21800	0.31	1.96	25100 5650	13200 2960	1.91	88800 20000		359-S	352A
46.037 1.8125	90.119 3.5480	23.000 0.9055	97000 21800	0.31	1.96	25100 5650	13200 2960	1.91	88800 20000		359-S	352
46.037 1.8125	93.264 3.6718	30.162 1.1875	122000 27500	0.34	1.77	31700 7120	18300 4120	1.73	153000 34300		3777	3720
46.037 1.8125	95.250 3.7500	27.783 1.0938	127000 28500	0.28	2.11	32900 7400	16000 3600	2.05	144000 32400		436	432
46.037 1.8125	95.250 3.7500	31.753 1.2501	127000 28500	0.28	2.11	32900 7400	16000 3600	2.05	144000 32400		436	432X
47.625 1.8750	88.900 3.5000	20.638 0.8125	102000 22900	0.32	1.88	26400 5930	14400 3250	1.83	95800 21500		369A	362A

<sup>(1)</sup>Based on 1 x 10<sup>6</sup> revolutions L<sub>10</sub> life, for the ISO life-calculation method.

<sup>(2)</sup>Consult your Timken engineer for instructions on use or review the Timken Engineering Manual on timken.com/catalogs.

<sup>(3)</sup>Based on 90 x 10<sup>6</sup> revolutions L<sub>10</sub> life, for The Timken Company life-calculation method. C<sub>90</sub> and C<sub>a90</sub> are radial and thrust values.

Bearing Dimensions											Geometry Factors			Bearing Weight
Width B	Width C	Eff. Ctr. a <sup>(4)</sup>	Shaft			Housing			Cage		G <sub>1</sub>	G <sub>2</sub>	C <sub>g</sub>	
			Max Shaft Fillet Radius R <sup>(5)</sup>	Backing Shoulder Dia. d <sub>a</sub>	Shoulder Dia. d <sub>b</sub>	Max Housing Fillet Radius r <sup>(5)</sup>	Backing Shoulder Dia. D <sub>a</sub>	Shoulder Dia. D <sub>b</sub>	A <sub>a</sub> <sup>(6)</sup>	A <sub>b</sub> <sup>(7)</sup>				
mm in.	mm in.	mm in.	mm in.	mm in.	mm in.	mm in.	mm in.	mm in.	mm in.	mm in.				kg lbs.
17.462 0.6875	13.495 0.5313	-2.0 -0.08	2.8 0.11	51.0 2.01	56.0 2.20	1.5 0.06	74.0 2.91	71.0 2.80	0.7 0.02	1.6 0.07	23.9	18.7	0.0725	0.32 0.73
17.462 0.6875	14.288 0.5625	0.8 0.03	0.8 0.03	52.0 2.05	52.0 2.05	1.5 0.06	76.0 2.99	72.0 2.83	1.6 0.06	2.0 0.08	23.0	19.2	0.0799	0.37 0.83
25.400 1.0000	19.050 0.7500	-6.4 -0.25	3.5 0.14	52.0 2.05	58.0 2.28	0.8 0.03	77.0 3.03	74.0 2.91	1.0 0.04	0.7 0.03	35.2	14.3	0.0801	0.53 1.17
21.692 0.8540	23.812 0.9375	-4.8 -0.19	2.3 0.09	51.0 2.01	55.0 2.17	3.3 0.13	79.5 3.13	74.0 2.91	0.4 0.01	1.7 0.07	30.0	12.2	0.0732	0.55 1.21
21.692 0.8540	17.462 0.6875	-4.8 -0.19	3.5 0.14	51.0 2.01	57.0 2.24	1.3 0.05	80.0 3.15	77.0 3.03	0.4 0.01	1.7 0.07	30.0	12.2	0.0732	0.48 1.07
21.692 0.8540	17.462 0.6875	-4.8 -0.19	2.3 0.09	51.0 2.01	55.0 2.17	1.3 0.05	80.0 3.15	77.0 3.03	0.4 0.01	1.7 0.07	30.0	12.2	0.0732	0.49 1.08
21.692 0.8540	17.462 0.6875	-4.8 -0.19	2.3 0.09	51.0 2.01	55.0 2.17	1.5 0.06	80.0 3.15	77.0 3.03	0.4 0.01	1.7 0.07	30.0	12.2	0.0732	0.49 1.08
25.608 1.0082	20.638 0.8125	-6.4 -0.25	3.5 0.14	52.0 2.05	58.0 2.28	1.3 0.05	80.0 3.15	76.0 2.99	1.7 0.07	1.1 0.05	38.2	15.7	0.0832	0.61 1.34
25.608 1.0082	20.638 0.8125	-6.4 -0.25	0.8 0.03	52.0 2.05	53.0 2.09	1.3 0.05	80.0 3.15	76.0 2.99	1.7 0.07	1.1 0.05	38.2	15.7	0.0832	0.62 1.35
21.692 0.8540	23.812 0.9375	-4.8 -0.19	2.3 0.09	51.0 2.01	55.0 2.17	3.3 0.13	81.0 3.19	75.0 2.95	0.4 0.01	1.7 0.07	30.0	12.2	0.0732	0.63 1.38
25.608 1.0082	22.225 0.8750	-6.4 -0.25	3.5 0.14	52.0 2.05	58.0 2.28	2.3 0.09	81.0 3.19	75.0 2.95	1.7 0.07	1.1 0.05	38.2	15.7	0.0832	0.68 1.50
21.692 0.8540	21.808 0.8586	-4.8 -0.19	2.3 0.09	51.0 2.01	55.0 2.17	2.3 0.09	81.0 3.19	78.0 3.07	0.4 0.01	1.7 0.07	30.0	12.2	0.0732	0.62 1.36
21.692 0.8540	21.808 0.8586	-4.8 -0.19	2.3 0.09	51.0 2.01	55.0 2.17	2.3 0.09	82.0 3.23	78.0 3.07	0.4 0.01	1.7 0.07	30.0	12.2	0.0732	0.65 1.43
30.302 1.1930	23.812 0.9375	-8.1 -0.32	3.5 0.14	53.0 2.09	60.0 2.36	3.3 0.13	87.9 3.46	82.0 3.23	1.8 0.07	1.0 0.04	49.9	14.5	0.0903	0.94 2.06
29.900 1.1772	22.225 0.8750	-9.1 -0.36	3.5 0.14	52.0 2.05	59.0 2.32	2.3 0.09	87.0 3.43	83.0 3.27	1.6 0.06	0.5 0.02	42.5	11.3	0.0805	0.91 2.00
29.900 1.1772	26.195 1.0313	-9.1 -0.36	3.5 0.14	52.0 2.05	59.0 2.32	3.3 0.13	87.0 3.43	81.0 3.19	1.6 0.06	0.5 0.02	42.5	11.3	0.0805	0.99 2.18
22.225 0.8750	16.513 0.6501	-4.3 -0.17	3.5 0.14	53.0 2.09	60.0 2.36	1.3 0.05	84.0 3.31	81.0 3.19	0.4 0.01	1.1 0.04	33.8	14.0	0.0773	0.56 1.21

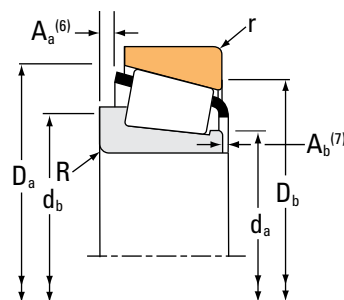
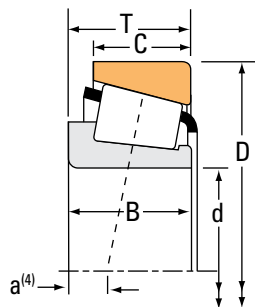
(4) Negative value indicates effective center inside cone (inner-ring) backface.  
 (5) These maximum fillet radii will be cleared by the bearing corners.  
 (6) Negative value indicates cage extends beyond cone (inner-ring) backface.  
 (7) Negative value indicates cage that does not extend beyond cone (inner-ring) front face.

Continued on next page.

# TAPERED ROLLER BEARINGS

## SINGLE-ROW • TYPE TS

### TYPE TS



Bearing Dimensions			Load Ratings							Part Number		
Bore d	O.D. D	Width T	Dynamic <sup>(1)</sup> C <sub>1</sub>		Factors <sup>(2)</sup> e Y		Dynamic <sup>(3)</sup> C <sub>90</sub> C <sub>a90</sub>		Factors <sup>(2)</sup> K	Static C <sub>0</sub>	Inner	Outer
mm in.	mm in.	mm in.	N lbf				N lbf	N lbf		N lbf		
47.625 1.8750	88.900 3.5000	20.638 0.8125	102000 22900	0.32	1.88		26400 5930	14400 3250	1.83	95800 21500	369-S	362A
47.625 1.8750	88.900 3.5000	25.400 1.0000	98600 22200	0.55	1.10		25600 5740	23900 5370	1.07	116000 26100	M804049	M804010
47.625 1.8750	88.900 3.5000	25.400 1.0000	98600 22200	0.55	1.10		25600 5740	23900 5370	1.07	116000 26100	M804048	M804010
47.625 1.8750	90.000 3.5433	20.000 0.7874	102000 22900	0.32	1.88		26400 5930	14400 3250	1.83	95800 21500	369-S	362
47.625 1.8750	90.000 3.5433	20.000 0.7874	102000 22900	0.32	1.88		26400 5930	14400 3250	1.83	95800 21500	369A	362
47.625 1.8750	93.264 3.6718	30.162 1.1875	122000 27500	0.34	1.77		31700 7120	18300 4120	1.73	153000 34300	3779	3720
47.625 1.8750	93.264 3.6718	30.162 1.1875	122000 27500	0.34	1.77		31700 7120	18300 4120	1.73	153000 34300	3778	3720
47.625 1.8750	93.264 3.6718	30.162 1.1875	122000 27500	0.34	1.77		31700 7120	18300 4120	1.73	153000 34300	3779	3730
47.625 1.8750	95.250 3.7500	30.162 1.1875	122000 27500	0.34	1.77		31700 7120	18300 4120	1.73	153000 34300	3779	3726
47.625 1.8750	95.250 3.7500	30.162 1.1875	147000 33100	0.55	1.10		38200 8590	35700 8030	1.07	157000 35400	HM804846	HM804810
47.625 1.8750	96.838 3.8125	21.000 0.8268	108000 24200	0.35	1.69		28000 6280	16900 3810	1.65	107000 24100	386A	382A
47.625 1.8750	98.425 3.8750	30.162 1.1875	122000 27500	0.34	1.77		31700 7120	18300 4120	1.73	153000 34300	3779	3732
47.625 1.8750	100.000 3.9370	34.925 1.3750	165000 37000	0.29	2.10		42700 9600	20800 4690	2.05	191000 43000	528	520X
47.625 1.8750	101.600 4.0000	31.750 1.2500	133000 29800	0.40	1.50		34400 7740	23600 5310	1.46	155000 35000	49580	49520
47.625 1.8750	101.600 4.0000	34.925 1.3750	165000 37000	0.29	2.10		42700 9600	20800 4690	2.05	191000 43000	528	522
47.625 1.8750	101.600 4.0000	34.925 1.3750	165000 37000	0.29	2.10		42700 9600	20800 4690	2.05	191000 43000	528A	522
47.625 1.8750	101.600 4.0000	34.925 1.3750	133000 29800	0.40	1.50		34400 7740	23600 5310	1.46	155000 35000	49580	49521

<sup>(1)</sup>Based on 1 x 10<sup>6</sup> revolutions L<sub>10</sub> life, for the ISO life-calculation method.

<sup>(2)</sup>Consult your Timken engineer for instructions on use or review the Timken Engineering Manual on timken.com/catalogs.

<sup>(3)</sup>Based on 90 x 10<sup>6</sup> revolutions L<sub>10</sub> life, for The Timken Company life-calculation method. C<sub>90</sub> and C<sub>a90</sub> are radial and thrust values.

Bearing Dimensions											Geometry Factors			Bearing Weight
Width B	Width C	Eff. Ctr. a <sup>(4)</sup>	Shaft			Housing			Cage		G <sub>1</sub>	G <sub>2</sub>	C <sub>g</sub>	
			Max Shaft Fillet Radius R <sup>(5)</sup>	Backing Shoulder Dia. d <sub>a</sub>	Shoulder Dia. d <sub>b</sub>	Max Housing Fillet Radius r <sup>(5)</sup>	Backing Shoulder Dia. D <sub>a</sub>	Shoulder Dia. D <sub>b</sub>	A <sub>a</sub> <sup>(6)</sup>	A <sub>b</sub> <sup>(7)</sup>				
mm in.	mm in.	mm in.	mm in.	mm in.	mm in.	mm in.	mm in.	mm in.	mm in.	mm in.				kg lbs.
22.225 0.8750	16.513 0.6501	-4.3 -0.17	2.3 0.09	53.0 2.09	57.0 2.24	1.3 0.05	84.0 3.31	81.0 3.19	0.4 0.01	1.1 0.04	33.8	14.0	0.0773	0.56 1.22
25.400 1.0000	19.050 0.7500	-1.8 -0.07	3.5 0.14	56.0 2.20	65.0 2.56	3.3 0.13	85.0 3.35	77.0 3.03	1.6 0.06	2.0 0.08	33.9	12.5	0.0924	0.66 1.45
25.400 1.0000	19.050 0.7500	-1.8 -0.07	0.8 0.03	56.0 2.20	59.0 2.32	3.3 0.13	85.0 3.35	77.0 3.03	1.6 0.06	2.0 0.08	33.9	12.5	0.0924	0.66 1.46
22.225 0.8750	15.875 0.6250	-4.3 -0.17	2.3 0.09	53.0 2.09	57.0 2.24	2.0 0.08	84.0 3.31	81.0 3.19	0.4 0.01	1.1 0.04	33.8	14.0	0.0773	0.56 1.23
22.225 0.8750	15.875 0.6250	-4.3 -0.17	3.5 0.14	53.0 2.09	60.0 2.36	2.0 0.08	84.0 3.31	81.0 3.19	0.4 0.01	1.1 0.04	33.8	14.0	0.0773	0.56 1.23
30.302 1.1930	23.812 0.9375	-8.1 -0.32	3.5 0.14	55.0 2.17	61.0 2.40	3.3 0.13	87.9 3.46	82.0 3.23	1.8 0.07	1.0 0.04	49.9	14.5	0.0903	0.91 2.00
30.302 1.1930	23.812 0.9375	-8.1 -0.32	6.4 0.25	55.0 2.17	67.0 2.64	3.3 0.13	87.9 3.46	82.0 3.23	1.8 0.07	1.0 0.04	49.9	14.5	0.0903	0.89 1.96
30.302 1.1930	23.812 0.9375	-8.1 -0.32	3.5 0.14	55.0 2.17	61.0 2.40	0.8 0.03	88.0 3.46	84.0 3.31	1.8 0.07	1.0 0.04	49.9	14.5	0.0903	0.92 2.01
30.302 1.1930	23.812 0.9375	-8.1 -0.32	3.5 0.14	55.0 2.17	61.0 2.40	3.3 0.13	88.9 3.50	83.1 3.27	1.8 0.07	1.0 0.04	49.9	14.5	0.0903	0.96 2.10
29.370 1.1563	23.020 0.9063	-3.8 -0.15	3.5 0.14	57.0 2.26	66.0 2.60	3.3 0.13	91.0 3.58	81.0 3.19	2.2 0.09	2.8 0.11	44.8	13.8	0.1017	0.97 2.14
21.946 0.8640	15.875 0.6250	-3.0 -0.12	0.8 0.03	55.0 2.17	56.0 2.20	0.8 0.03	92.0 3.62	89.0 3.50	1.1 0.04	2.0 0.08	42.0	15.7	0.0859	0.73 1.60
30.302 1.1930	23.812 0.9375	-8.1 -0.32	3.5 0.14	55.0 2.17	61.0 2.40	3.3 0.13	89.9 3.54	84.1 3.31	1.8 0.07	1.0 0.04	49.9	14.5	0.0903	1.05 2.30
36.068 1.4200	26.988 1.0625	-12.7 -0.50	3.5 0.14	55.0 2.17	62.0 2.44	3.3 0.13	94.0 3.70	88.0 3.46	2.7 0.10	1.8 0.07	57.9	13.4	0.0894	1.24 2.75
31.750 1.2500	25.400 1.0000	-7.1 -0.28	3.5 0.14	56.0 2.20	63.0 2.48	3.3 0.13	96.0 3.78	88.0 3.46	2.3 0.09	1.4 0.06	49.1	16.8	0.0946	1.18 2.60
36.068 1.4200	26.988 1.0625	-12.7 -0.50	3.5 0.14	55.0 2.17	62.0 2.44	3.3 0.13	95.0 3.74	89.0 3.50	2.7 0.10	1.8 0.07	57.9	13.4	0.0894	1.30 2.86
36.068 1.4200	26.988 1.0625	-12.7 -0.50	1.5 0.06	55.0 2.17	58.0 2.28	3.3 0.13	95.0 3.74	89.0 3.50	2.7 0.10	1.8 0.07	57.9	13.4	0.0894	1.30 2.88
31.750 1.2500	28.575 1.1250	-7.1 -0.28	3.5 0.14	56.0 2.20	63.0 2.48	3.3 0.13	96.0 3.78	87.0 3.43	2.3 0.09	1.4 0.06	49.1	16.8	0.0946	1.25 2.76

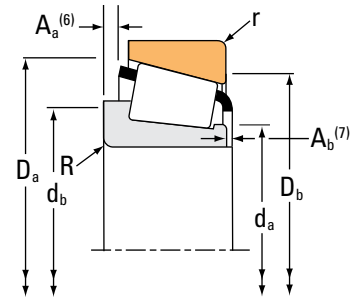
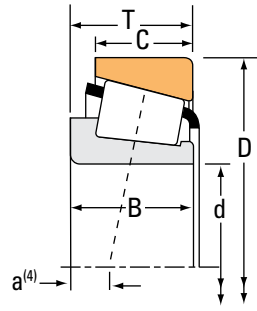
(4) Negative value indicates effective center inside cone (inner-ring) backface.  
 (5) These maximum fillet radii will be cleared by the bearing corners.  
 (6) Negative value indicates cage extends beyond cone (inner-ring) backface.  
 (7) Negative value indicates cage that does not extend beyond cone (inner-ring) front face.

Continued on next page.

# TAPERED ROLLER BEARINGS

## SINGLE-ROW • TYPE TS

### TYPE TS



Bearing Dimensions			Load Ratings							Part Number			
Bore d	O.D. D	Width T	Dynamic <sup>(1)</sup>		Factors <sup>(2)</sup>		Dynamic <sup>(3)</sup>		Factors <sup>(2)</sup>		Static C <sub>0</sub>	Inner	Outer
			C <sub>1</sub>	e	Y	C <sub>90</sub>	C <sub>a90</sub>	K	N	N			
mm in.	mm in.	mm in.	N lbf			N lbf	N lbf		N lbf				
47.625 1.8750	101.600 4.0000	34.925 1.3750	165000 37000	0.29	2.10	42700 9600	20800 4690	2.05	191000 43000			528R	522
47.625 1.8750	103.188 4.0625	43.658 1.7188	212000 47700	0.30	2.02	55000 12400	27900 6280	1.97	267000 60100			5361	5335
47.625 1.8750	103.188 4.0625	43.658 1.7188	212000 47700	0.30	2.02	55000 12400	27900 6280	1.97	267000 60100			5358	5335
47.625 1.8750	104.775 4.1250	30.162 1.1875	153000 34500	0.33	1.80	39700 8930	22600 5090	1.76	189000 42600			45282	45221
47.625 1.8750	104.775 4.1250	30.162 1.1875	153000 34500	0.33	1.80	39700 8930	22600 5090	1.76	189000 42600			45282	45220
47.625 1.8750	104.775 4.1250	36.512 1.4375	202000 45500	0.40	1.49	52400 11800	36100 8110	1.45	202000 45400			59187	59412
47.625 1.8750	104.775 4.1250	36.512 1.4375	202000 45500	0.40	1.49	52400 11800	36100 8110	1.45	202000 45400			59188	59412
47.625 1.8750	107.950 4.2500	27.783 1.0938	161000 36100	0.34	1.79	41700 9370	23900 5380	1.74	166000 37200			467	453A
47.625 1.8750	107.950 4.2500	36.512 1.4375	172000 38700	0.30	2.02	44600 10000	22700 5090	1.97	206000 46200			536	532X
47.625 1.8750	108.966 4.2900	34.925 1.3750	202000 45500	0.40	1.49	52400 11800	36100 8110	1.45	202000 45400			59187	59429
47.625 1.8750	108.966 4.2900	34.925 1.3750	202000 45500	0.40	1.49	52400 11800	36100 8110	1.45	202000 45400			59188	59429
47.625 1.8750	111.125 4.3750	30.162 1.1875	123000 27700	0.88	0.68	31900 7170	48200 10800	0.66	153000 34400			HM907639	HM907614
47.625 1.8750	111.125 4.3750	30.162 1.1875	151000 34000	0.88	0.68	39200 8810	59300 13300	0.66	161000 36200			55187C	55437
47.625 1.8750	111.125 4.3750	38.100 1.5000	172000 38700	0.30	2.02	44600 10000	22700 5090	1.97	206000 46200			536	532
47.625 1.8750	112.712 4.4375	30.162 1.1875	126000 28300	0.88	0.68	32700 7350	49500 11100	0.66	119000 26700			55187	55443
47.625 1.8750	112.712 4.4375	30.162 1.1875	123000 27700	0.88	0.68	31900 7170	48200 10800	0.66	153000 34400			HM907639	HM907616
47.625 1.8750	112.712 4.4375	30.162 1.1875	151000 34000	0.88	0.68	39200 8810	59300 13300	0.66	161000 36200			55187C	55443

<sup>(1)</sup>Based on 1 x 10<sup>6</sup> revolutions L<sub>10</sub> life, for the ISO life-calculation method.

<sup>(2)</sup>Consult your Timken engineer for instructions on use or review the Timken Engineering Manual on timken.com/catalogs.

<sup>(3)</sup>Based on 90 x 10<sup>6</sup> revolutions L<sub>10</sub> life, for The Timken Company life-calculation method. C<sub>90</sub> and C<sub>a90</sub> are radial and thrust values.

Bearing Dimensions											Geometry Factors			Bearing Weight
Width B	Width C	Eff. Ctr. a <sup>(4)</sup>	Shaft			Housing			Cage		G <sub>1</sub>	G <sub>2</sub>	C <sub>g</sub>	
			Max Shaft Fillet Radius R <sup>(5)</sup>	Backing Shoulder Dia. d <sub>a</sub>	Shoulder Dia. d <sub>b</sub>	Max Housing Fillet Radius r <sup>(5)</sup>	Backing Shoulder Dia. D <sub>a</sub>	Shoulder Dia. D <sub>b</sub>	A <sub>a</sub> <sup>(6)</sup>	A <sub>b</sub> <sup>(7)</sup>				
mm in.	mm in.	mm in.	mm in.	mm in.	mm in.	mm in.	mm in.	mm in.	mm in.	mm in.				kg lbs.
36.068 1.4200	26.988 1.0625	-12.7 -0.50	8.0 0.31	55.0 2.17	70.0 2.76	3.3 0.13	95.0 3.74	89.0 3.50	2.7 0.10	1.8 0.07	57.9	13.4	0.0894	1.26 2.79
44.475 1.7510	36.512 1.4375	-16.0 -0.63	3.5 0.14	58.0 2.28	65.0 2.56	3.3 0.13	97.0 3.82	89.0 3.50	2.5 0.10	1.0 0.04	73.4	15.5	0.0985	1.76 3.88
44.475 1.7510	36.512 1.4375	-16.0 -0.63	1.3 0.05	58.0 2.28	60.0 2.36	3.3 0.13	97.0 3.82	89.0 3.50	2.5 0.10	1.0 0.04	73.4	15.5	0.0985	1.77 3.89
30.958 1.2188	23.812 0.9375	-8.1 -0.32	3.5 0.14	57.0 2.24	63.0 2.48	0.8 0.03	99.0 3.90	95.0 3.74	2.1 0.08	1.8 0.07	63.5	16.9	0.0971	1.27 2.80
30.958 1.2188	23.812 0.9375	-8.1 -0.32	3.5 0.14	57.0 2.24	63.0 2.48	3.3 0.13	99.0 3.90	93.0 3.66	2.1 0.08	1.8 0.07	63.5	16.9	0.0971	1.27 2.79
36.512 1.4375	28.575 1.1250	-9.7 -0.38	3.5 0.14	59.0 2.32	65.0 2.56	3.3 0.13	99.0 3.90	92.0 3.62	3.4 0.13	1.3 0.05	57.3	15.2	0.0999	1.48 3.25
36.512 1.4375	28.575 1.1250	-9.7 -0.38	1.5 0.06	59.0 2.32	61.0 2.40	3.3 0.13	99.0 3.90	92.0 3.62	3.4 0.13	1.3 0.05	57.3	15.2	0.0999	1.48 3.26
29.317 1.1542	22.225 0.8750	-7.1 -0.28	0.8 0.03	56.0 2.20	57.0 2.24	0.8 0.03	100.0 3.94	97.0 3.82	2.1 0.08	1.4 0.06	58.6	17.1	0.0946	1.28 2.83
36.957 1.4550	28.575 1.1250	-12.2 -0.48	3.5 0.14	56.0 2.20	62.0 2.44	3.3 0.13	100.0 3.94	94.0 3.70	2.7 0.10	1.0 0.04	64.3	16.1	0.0938	1.59 3.51
36.512 1.4375	26.988 1.0625	-9.7 -0.38	3.5 0.14	59.0 2.32	65.0 2.56	3.3 0.13	101.0 3.98	93.0 3.66	3.4 0.13	1.3 0.05	57.3	15.2	0.0999	1.59 3.49
36.512 1.4375	26.988 1.0625	-9.7 -0.38	1.5 0.06	59.0 2.32	61.0 2.40	3.3 0.13	101.0 3.98	93.0 3.66	3.4 0.13	1.3 0.05	57.3	15.2	0.0999	1.59 3.51
28.575 1.1250	20.638 0.8125	7.6 0.30	3.5 0.14	65.3 2.56	72.0 2.83	3.3 0.13	105.0 4.13	91.0 3.58	4.6 0.18	2.1 0.08	46.9	17.5	0.1182	1.40 3.08
26.909 1.0594	20.638 0.8125	7.6 0.30	3.5 0.14	62.0 2.44	69.0 2.72	3.3 0.13	105.0 4.13	92.0 3.62	5.0 0.19	3.7 0.15	48.7	18.1	0.1198	1.41 3.10
36.957 1.4550	33.338 1.3125	-12.2 -0.48	3.5 0.14	56.0 2.20	62.0 2.44	3.3 0.13	100.0 3.94	95.0 3.74	2.7 0.10	1.0 0.04	64.3	16.1	0.0938	1.82 4.01
26.909 1.0594	20.638 0.8125	7.1 0.28	3.5 0.14	62.0 2.44	69.0 2.72	3.3 0.13	106.0 4.17	92.0 3.62	4.8 0.18	3.2 0.13	36.8	13.2	0.1085	1.34 2.98
28.575 1.1250	20.638 0.8125	7.6 0.30	3.5 0.14	65.3 2.56	72.0 2.83	3.3 0.13	106.0 4.17	91.0 3.58	4.6 0.18	2.1 0.08	46.9	17.5	0.1182	1.46 3.22
26.909 1.0594	20.638 0.8125	7.6 0.30	3.5 0.14	62.0 2.44	69.0 2.72	3.3 0.13	106.0 4.17	92.0 3.62	5.0 0.19	3.7 0.15	48.7	18.1	0.1198	1.44 3.17

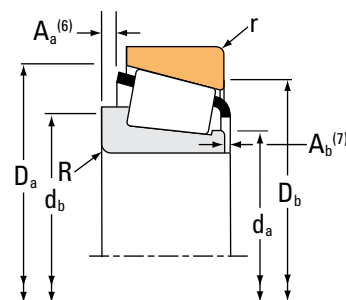
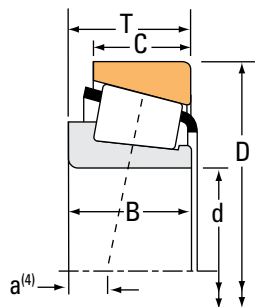
<sup>(4)</sup>Negative value indicates effective center inside cone (inner-ring) backface.  
<sup>(5)</sup>These maximum fillet radii will be cleared by the bearing corners.  
<sup>(6)</sup>Negative value indicates cage extends beyond cone (inner-ring) backface.  
<sup>(7)</sup>Negative value indicates cage that does not extend beyond cone (inner-ring) front face.

Continued on next page.

# TAPERED ROLLER BEARINGS

## SINGLE-ROW • TYPE TS

### TYPE TS



Bearing Dimensions			Load Ratings							Part Number			
Bore d	O.D. D	Width T	Dynamic <sup>(1)</sup>		Factors <sup>(2)</sup>		Dynamic <sup>(3)</sup>		Factors <sup>(2)</sup>		Static C <sub>0</sub>	Inner	Outer
			C <sub>1</sub>	e	Y	C <sub>90</sub>	C <sub>a90</sub>	K	N	N			
mm in.	mm in.	mm in.	N lbf			N lbf	N lbf		N lbf				
47.625 1.8750	117.475 4.6250	33.338 1.3125	177000 39700	0.63	0.96	45800 10300	49100 11000	0.93	166000 37300		66187	66462	
47.625 1.8750	120.650 4.7500	41.275 1.6250	207000 46600	0.31	1.91	53800 12100	28900 6510	1.86	244000 54800		617	612	
47.625 1.8750	123.825 4.8750	36.512 1.4375	214000 48200	0.74	0.81	55500 12500	70100 15800	0.79	208000 46800		72188C	72487	
47.625 1.8750	123.825 4.8750	36.512 1.4375	214000 48200	0.74	0.81	55500 12500	70100 15800	0.79	208000 46800		72187C	72487	
48.412 1.9060	95.250 3.7500	30.162 1.1875	147000 33100	0.55	1.10	38200 8590	35700 8030	1.07	157000 35400		HM804849	HM804810	
48.412 1.9060	95.250 3.7500	30.162 1.1875	147000 33100	0.55	1.10	38200 8590	35700 8030	1.07	157000 35400		HM804848	HM804810	
48.412 1.9060	95.250 3.7500	30.162 1.1875	147000 33100	0.55	1.10	38200 8590	35700 8030	1.07	157000 35400		HM804848A	HM804810	
48.600 1.9134	88.000 3.4646	21.500 0.8465	96300 21700	0.31	1.97	25000 5610	13000 2930	1.91	104000 23400		JLM104942A	JLM104914	
49.212 1.9375	88.900 3.5000	20.638 0.8125	102000 22900	0.32	1.88	26400 5930	14400 3250	1.83	95800 21500		365-S	362A	
49.212 1.9375	90.000 3.5433	25.001 0.9843	102000 22900	0.32	1.88	26400 5930	14400 3250	1.83	95800 21500		365-S	362X	
49.212 1.9375	93.264 3.6718	30.162 1.1875	122000 27500	0.34	1.77	31700 7120	18300 4120	1.73	153000 34300		3781	3720	
49.212 1.9375	103.188 4.0625	43.658 1.7188	212000 47700	0.30	2.02	55000 12400	27900 6280	1.97	267000 60100		5395	5335	
49.212 1.9375	104.775 4.1250	36.512 1.4375	203000 45700	0.49	1.23	52700 11900	44000 9890	1.20	223000 50200		HM807044	HM807010	
49.212 1.9375	114.300 4.5000	44.450 1.7500	224000 50300	0.43	1.39	58000 13000	42700 9600	1.36	256000 57500		65390	65320	
49.212 1.9375	114.300 4.5000	44.450 1.7500	246000 55300	0.40	1.49	63700 14300	43800 9860	1.45	290000 65100		HH506348	HH506310	
49.212 1.9375	114.300 4.5000	44.450 1.7500	246000 55300	0.40	1.49	63700 14300	43800 9860	1.45	290000 65100		HH506348	HH506311	
49.212 1.9375	122.238 4.8125	43.658 1.7188	237000 53200	0.36	1.67	61300 13800	37600 8460	1.63	327000 73500		5562	5535	

<sup>(1)</sup>Based on 1 x 10<sup>6</sup> revolutions L<sub>10</sub> life, for the ISO life-calculation method.

<sup>(2)</sup>Consult your Timken engineer for instructions on use or review the Timken Engineering Manual on timken.com/catalogs.

<sup>(3)</sup>Based on 90 x 10<sup>6</sup> revolutions L<sub>10</sub> life, for The Timken Company life-calculation method. C<sub>90</sub> and C<sub>a90</sub> are radial and thrust values.



Bearing Dimensions											Geometry Factors			Bearing Weight
Width B	Width C	Eff. Ctr. a <sup>(4)</sup>	Shaft			Housing			Cage		G <sub>1</sub>	G <sub>2</sub>	C <sub>g</sub>	
			Max Shaft Fillet Radius R <sup>(5)</sup>	Backing Shoulder Dia. d <sub>a</sub>	Shoulder Dia. d <sub>b</sub>	Max Housing Fillet Radius r <sup>(5)</sup>	Backing Shoulder Dia. D <sub>a</sub>	Shoulder Dia. D <sub>b</sub>	A <sub>a</sub> <sup>(6)</sup>	A <sub>b</sub> <sup>(7)</sup>				
mm in.	mm in.	mm in.	mm in.	mm in.	mm in.	mm in.	mm in.	mm in.	mm in.	mm in.				kg lbs.
31.750 1.2500	23.812 0.9375	-0.3 -0.01	3.5 0.14	62.0 2.44	69.0 2.72	3.3 0.13	111.0 4.37	100.0 3.94	5.0 0.19	2.0 0.08	50.2	16.4	0.0751	1.69 3.74
41.275 1.6250	31.750 1.2500	-14.0 -0.55	3.5 0.14	58.0 2.28	65.0 2.56	3.3 0.13	110.0 4.33	105.0 4.13	3.8 0.15	1.9 0.08	75.9	16.2	0.0694	2.35 5.18
32.791 1.2910	25.400 1.0000	2.0 0.08	0.8 0.03	67.0 2.64	69.0 2.72	3.3 0.13	116.0 4.57	102.0 4.02	4.7 0.18	4.4 0.18	57.4	15.9	0.0825	2.18 4.81
32.791 1.2910	25.400 1.0000	2.0 0.08	3.5 0.14	66.0 2.60	75.0 2.95	3.3 0.13	116.0 4.57	102.0 4.02	4.7 0.18	4.4 0.18	57.4	15.9	0.0825	2.15 4.76
29.370 1.1563	23.020 0.9063	-3.8 -0.15	3.5 0.14	57.0 2.26	66.0 2.60	3.3 0.13	91.0 3.58	81.0 3.19	2.2 0.09	2.8 0.11	44.8	13.8	0.1017	0.96 2.11
29.370 1.1563	23.020 0.9063	-3.8 -0.15	2.3 0.09	57.0 2.26	63.0 2.48	3.3 0.13	91.0 3.58	81.0 3.19	2.2 0.09	2.8 0.11	44.8	13.8	0.1017	0.96 2.12
29.370 1.1563	23.020 0.9063	-3.8 -0.15	2.3 0.09	57.0 2.26	63.0 2.48	3.3 0.13	91.0 3.58	81.0 3.19	2.2 0.09	2.8 0.11	44.8	13.8	0.1017	0.96 2.11
21.500 0.8465	17.000 0.6693	-5.3 -0.21	0.0 0.00	55.0 2.17	54.0 2.13	0.8 0.03	81.0 3.19	78.0 3.07	0.7 0.03	2.2 0.09	38.8	19.3	0.0801	0.56 1.23
22.225 0.8750	16.513 0.6501	-4.3 -0.17	0.8 0.03	54.0 2.13	55.0 2.17	1.3 0.05	84.0 3.31	81.0 3.19	0.4 0.01	1.1 0.04	33.8	14.0	0.0773	0.54 1.17
22.225 0.8750	20.000 0.7874	-4.3 -0.17	0.8 0.03	54.0 2.13	55.0 2.17	2.0 0.08	84.0 3.31	80.0 3.15	0.4 0.01	1.1 0.04	33.8	14.0	0.0773	0.62 1.36
30.302 1.1930	23.812 0.9375	-8.1 -0.32	3.5 0.14	56.0 2.20	62.0 2.44	3.3 0.13	87.9 3.46	82.0 3.23	1.8 0.07	1.0 0.04	49.9	14.5	0.0903	0.88 1.94
44.475 1.7510	36.512 1.4375	-16.0 -0.63	3.5 0.14	60.0 2.36	66.0 2.60	3.3 0.13	97.0 3.82	89.0 3.50	2.5 0.10	1.0 0.04	73.4	15.5	0.0985	1.72 3.78
36.512 1.4375	28.575 1.1250	-7.4 -0.29	3.5 0.14	63.0 2.48	69.0 2.72	3.3 0.13	100.0 3.94	89.0 3.50	3.4 0.13	2.0 0.08	63.9	17.1	0.0760	1.50 3.29
44.450 1.7500	34.925 1.3750	-12.4 -0.49	3.5 0.14	60.0 2.36	70.0 2.76	3.3 0.13	107.0 4.21	97.0 3.82	3.6 0.14	1.1 0.05	63.1	13.0	0.1053	2.19 4.82
44.450 1.7500	36.068 1.4200	-13.5 -0.53	3.5 0.14	61.0 2.40	71.0 2.80	3.3 0.13	107.0 4.21	97.0 3.82	2.7 0.10	3.3 0.13	72.0	15.6	0.1078	2.26 4.97
44.450 1.7500	36.068 1.4200	-13.5 -0.53	3.5 0.14	61.0 2.40	71.0 2.80	0.8 0.03	107.0 4.21	99.0 3.90	2.7 0.10	3.3 0.13	72.0	15.6	0.1078	2.28 5.00
43.764 1.7230	36.512 1.4375	-12.2 -0.48	1.3 0.05	63.0 2.48	65.0 2.56	3.3 0.13	116.0 4.57	106.0 4.17	2.5 0.09	1.3 0.05	110.4	24.2	0.0825	2.72 6.02

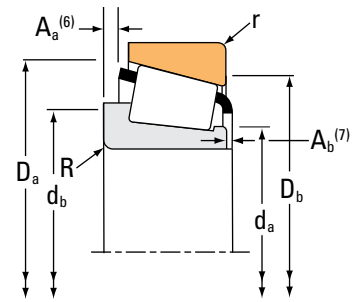
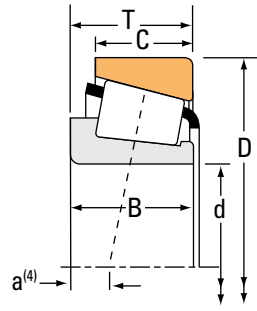
<sup>(4)</sup>Negative value indicates effective center inside cone (inner-ring) backface.  
<sup>(5)</sup>These maximum fillet radii will be cleared by the bearing corners.  
<sup>(6)</sup>Negative value indicates cage extends beyond cone (inner-ring) backface.  
<sup>(7)</sup>Negative value indicates cage that does not extend beyond cone (inner-ring) front face.

Continued on next page.

# TAPERED ROLLER BEARINGS

## SINGLE-ROW • TYPE TS

### TYPE TS



Bearing Dimensions			Load Ratings							Part Number			
Bore d	O.D. D	Width T	Dynamic <sup>(1)</sup>		Factors <sup>(2)</sup>		Dynamic <sup>(3)</sup>		Factors <sup>(2)</sup>		Static C <sub>0</sub>	Inner	Outer
			C <sub>1</sub>	e	Y	C <sub>90</sub>	C <sub>a90</sub>	K	N	N			
mm in.	mm in.	mm in.	N lbf			N lbf	N lbf		N lbf				
49.974 1.9675	111.125 4.3750	30.162 1.1875	126000 28300	0.88	0.68	32700 7350	49500 11100	0.66	119000 26700		55196	55437	
49.982 1.9678	107.950 4.2500	36.512 1.4375	172000 38700	0.30	2.02	44600 10000	22700 5090	1.97	206000 46200		546	532X	
49.987 1.9680	79.975 3.1486	18.258 0.7188	60800 13700	0.36	1.69	15800 3540	9590 2160	1.64	88800 20000		L305648	L305611	
49.987 1.9680	80.962 3.1875	18.258 0.7188	60800 13700	0.36	1.69	15800 3540	9590 2160	1.64	88800 20000		L305648	L305610	
49.987 1.9680	82.000 3.2283	21.976 0.8652	96300 21700	0.31	1.97	25000 5610	13000 2930	1.91	104000 23400		LM104947A	JLM104910	
49.987 1.9680	89.980 3.5425	24.750 0.9744	98900 22200	0.38	1.59	25700 5770	16600 3720	1.55	130000 29200		28579	28520	
49.987 1.9680	92.075 3.6250	24.608 0.9688	98900 22200	0.38	1.59	25700 5770	16600 3720	1.55	130000 29200		28579	28521	
49.987 1.9680	96.838 3.8125	22.225 0.8750	87900 19800	0.34	1.77	22800 5120	13200 2970	1.73	101000 22700		378A	372A	
49.987 1.9680	114.300 4.5000	44.450 1.7500	246000 55300	0.40	1.49	63700 14300	43800 9860	1.45	290000 65100		HH506349	HH506311	
50.000 1.9685	82.000 3.2283	21.500 0.8465	81300 18300	0.31	1.97	21100 4740	11000 2470	1.91	104000 23400		JLM104948	JLM104910	
50.000 1.9685	82.550 3.2500	21.115 0.8313	96300 21700	0.31	1.97	25000 5610	13000 2930	1.91	104000 23400		JLM104948	LM104911	
50.000 1.9685	82.550 3.2500	23.147 0.9113	96300 21700	0.31	1.97	25000 5610	13000 2930	1.91	104000 23400		JLM104948	LM104911A	
50.000 1.9685	82.931 3.2650	21.115 0.8313	96300 21700	0.31	1.97	25000 5610	13000 2930	1.91	104000 23400		JLM104948	LM104912	
50.000 1.9685	84.000 3.3071	22.000 0.8661	81400 18300	0.44	1.37	21100 4740	15800 3550	1.34	104000 23500		JLM704649	JLM704610	
50.000 1.9685	88.900 3.5000	20.638 0.8125	102000 22900	0.32	1.88	26400 5930	14400 3250	1.83	95800 21500		366	362A	
50.000 1.9685	88.900 3.5000	20.638 0.8125	102000 22900	0.32	1.88	26400 5930	14400 3250	1.83	95800 21500		365	362A	
50.000 1.9685	90.000 3.5433	20.000 0.7874	102000 22900	0.32	1.88	26400 5930	14400 3250	1.83	95800 21500		366	362	

<sup>(1)</sup>Based on 1 x 10<sup>6</sup> revolutions L<sub>10</sub> life, for the ISO life-calculation method.

<sup>(2)</sup>Consult your Timken engineer for instructions on use or review the Timken Engineering Manual on timken.com/catalogs.

<sup>(3)</sup>Based on 90 x 10<sup>6</sup> revolutions L<sub>10</sub> life, for The Timken Company life-calculation method. C<sub>90</sub> and C<sub>a90</sub> are radial and thrust values.

Bearing Dimensions											Geometry Factors			Bearing Weight
Width B	Width C	Eff. Ctr. a <sup>(4)</sup>	Shaft			Housing			Cage		G <sub>1</sub>	G <sub>2</sub>	C <sub>g</sub>	
			Max Shaft Fillet Radius R <sup>(5)</sup>	Backing Shoulder Dia. d <sub>a</sub>	Backing Shoulder Dia. d <sub>b</sub>	Max Housing Fillet Radius r <sup>(5)</sup>	Backing Shoulder Dia. D <sub>a</sub>	Backing Shoulder Dia. D <sub>b</sub>	A <sub>a</sub> <sup>(6)</sup>	A <sub>b</sub> <sup>(7)</sup>				
mm in.	mm in.	mm in.	mm in.	mm in.	mm in.	mm in.	mm in.	mm in.	mm in.	mm in.				kg lbs.
26.909 1.0594	20.638 0.8125	7.1 0.28	3.5 0.14	63.9 2.51	71.0 2.80	3.3 0.13	105.0 4.13	92.0 3.62	4.8 0.18	3.2 0.13	36.8	13.2	0.1085	1.28 2.82
36.957 1.4550	28.575 1.1250	-12.2 -0.48	3.5 0.14	58.0 2.28	65.0 2.56	3.3 0.13	100.0 3.94	94.0 3.70	2.7 0.10	1.0 0.04	64.3	16.1	0.0938	1.54 3.40
18.258 0.7188	14.288 0.5625	-2.5 -0.10	1.5 0.06	55.0 2.17	57.0 2.24	1.5 0.06	76.0 2.99	73.0 2.87	0.2 0.01	2.0 0.08	38.8	29.8	0.0841	0.34 0.76
18.258 0.7188	14.288 0.5625	-2.5 -0.10	1.5 0.06	55.0 2.17	57.0 2.24	1.5 0.06	77.0 3.03	73.0 2.87	0.2 0.01	2.0 0.08	38.8	29.8	0.0841	0.36 0.79
22.225 0.8750	17.000 0.6693	-5.8 -0.23	0.5 0.02	55.0 2.17	55.0 2.17	0.5 0.02	78.0 3.07	76.0 2.99	1.1 0.04	2.0 0.08	38.8	19.3	0.0801	0.44 0.97
25.400 1.0000	19.987 0.7869	-4.8 -0.19	2.3 0.09	56.0 2.20	60.0 2.36	2.3 0.09	86.0 3.39	81.0 3.19	1.4 0.05	1.1 0.05	46.4	18.9	0.0912	0.66 1.46
25.400 1.0000	19.845 0.7813	-4.8 -0.19	2.3 0.09	56.0 2.20	60.0 2.36	0.8 0.03	87.0 3.43	83.0 3.27	1.4 0.05	1.1 0.05	46.4	18.9	0.0912	0.70 1.57
22.225 0.8750	19.050 0.7500	-3.8 -0.15	2.3 0.09	56.0 2.20	60.0 2.36	1.5 0.06	90.0 3.54	86.0 3.39	0.8 0.03	1.5 0.06	37.6	15.4	0.0816	0.72 1.60
44.450 1.7500	36.068 1.4200	-13.5 -0.53	3.5 0.14	61.0 2.40	72.0 2.83	0.8 0.03	107.0 4.21	99.0 3.90	2.7 0.10	3.3 0.13	72.0	15.6	0.1078	2.25 4.96
21.500 0.8465	17.000 0.6693	-5.3 -0.21	3.0 0.12	55.0 2.17	61.0 2.40	0.5 0.02	78.0 3.07	76.0 2.99	0.7 0.03	2.2 0.09	38.8	19.3	0.0801	0.42 0.94
21.500 0.8465	16.510 0.6500	-5.3 -0.21	3.0 0.12	55.0 2.17	61.0 2.40	1.3 0.05	78.0 3.07	75.0 2.95	0.7 0.03	2.2 0.09	38.8	19.3	0.0801	0.42 0.94
21.500 0.8465	18.542 0.7300	-5.3 -0.21	3.0 0.12	55.0 2.17	61.0 2.40	0.8 0.03	78.0 3.07	75.0 2.95	0.7 0.03	2.2 0.09	38.8	19.3	0.0801	0.45 1.00
21.500 0.8465	16.510 0.6500	-5.3 -0.21	3.0 0.12	55.0 2.17	61.0 2.40	1.3 0.05	78.0 3.06	75.0 2.95	0.7 0.03	2.2 0.09	38.8	19.3	0.0801	0.43 0.96
22.000 0.8661	17.500 0.6890	-2.3 -0.09	3.5 0.14	56.0 2.20	64.0 2.52	1.5 0.06	80.0 3.15	76.0 2.99	1.1 0.04	1.6 0.07	35.6	16.7	0.0876	0.46 1.03
22.225 0.8750	16.513 0.6501	-4.3 -0.17	2.3 0.09	55.0 2.17	59.0 2.32	1.3 0.05	84.0 3.31	81.0 3.19	0.4 0.01	1.1 0.04	33.8	14.0	0.0773	0.53 1.15
22.225 0.8750	16.513 0.6501	-4.3 -0.17	2.0 0.08	55.0 2.17	58.0 2.28	1.3 0.05	84.0 3.31	81.0 3.19	0.4 0.01	1.1 0.04	33.8	14.0	0.0773	0.53 1.15
22.225 0.8750	15.875 0.6250	-4.3 -0.17	2.3 0.09	55.0 2.17	59.0 2.32	2.0 0.08	84.0 3.31	81.0 3.19	0.4 0.01	1.1 0.04	33.8	14.0	0.0773	0.53 1.16

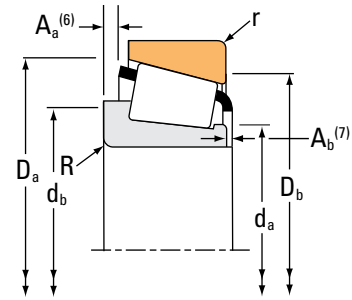
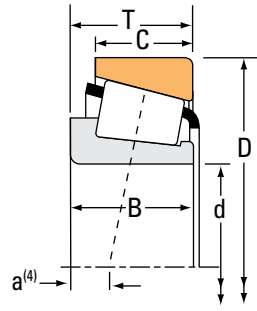
<sup>(4)</sup>Negative value indicates effective center inside cone (inner-ring) backface.  
<sup>(5)</sup>These maximum fillet radii will be cleared by the bearing corners.  
<sup>(6)</sup>Negative value indicates cage extends beyond cone (inner-ring) backface.  
<sup>(7)</sup>Negative value indicates cage that does not extend beyond cone (inner-ring) front face.

Continued on next page.

# TAPERED ROLLER BEARINGS

## SINGLE-ROW • TYPE TS

### TYPE TS



Bearing Dimensions			Load Ratings							Part Number			
Bore d	O.D. D	Width T	Dynamic <sup>(1)</sup>		Factors <sup>(2)</sup>		Dynamic <sup>(3)</sup>		Factors <sup>(2)</sup>		Static C <sub>0</sub>	Inner	Outer
			C <sub>1</sub>	e	Y	C <sub>90</sub>	C <sub>a90</sub>	K	N	N			
mm in.	mm in.	mm in.	N lbf			N lbf	N lbf		N lbf				
50.000 1.9685	90.000 3.5433	20.000 0.7874	102000 22900	0.32	1.88	26400 5930	14400 3250	1.83	95800 21500			366	363
50.000 1.9685	90.000 3.5433	20.000 0.7874	102000 22900	0.32	1.88	26400 5930	14400 3250	1.83	95800 21500			365	363
50.000 1.9685	90.000 3.5433	20.000 0.7874	102000 22900	0.32	1.88	26400 5930	14400 3250	1.83	95800 21500			365	362
50.000 1.9685	90.000 3.5433	28.000 1.1024	124000 27800	0.33	1.82	32100 7210	18100 4060	1.78	154000 34600			JM205149	JM205110
50.000 1.9685	90.000 3.5433	28.000 1.1024	147000 33000	0.33	1.82	38000 8540	21400 4810	1.78	154000 34600			JM205149A	JM205110
50.000 1.9685	90.000 3.5433	28.000 1.1024	147000 33000	0.33	1.82	38000 8540	21400 4810	1.78	154000 34600			JM205149	JM205110A
50.000 1.9685	90.000 3.5433	28.000 1.1024	147000 33000	0.33	1.82	38000 8540	21400 4810	1.78	154000 34600			JM205149AS	JM205110
50.000 1.9685	105.000 4.1339	32.000 1.2598	142000 31800	0.87	0.69	36700 8250	54400 12200	0.67	138000 31000			JW5049	JW5010
50.000 1.9685	105.000 4.1339	37.000 1.4567	172000 38600	0.49	1.23	44500 10000	37100 8350	1.20	223000 50200			JHM807045	JHM807012
50.800 2.0000	77.788 3.0625	12.700 0.5000	37300 8390	0.34	1.78	9680 2180	5570 1250	1.74	47200 10600			LL205449	LL205410
50.800 2.0000	80.962 3.1875	18.258 0.7188	60800 13700	0.36	1.69	15800 3540	9590 2160	1.64	88800 20000			L305649	L305610
50.800 2.0000	82.000 3.2283	21.976 0.8652	96300 21700	0.31	1.97	25000 5610	13000 2930	1.91	104000 23400			LM104949	JLM104910
50.800 2.0000	82.550 3.2500	21.590 0.8500	96300 21700	0.31	1.97	25000 5610	13000 2930	1.91	104000 23400			LM104949	LM104911
50.800 2.0000	82.550 3.2500	23.622 0.9300	96300 21700	0.31	1.97	25000 5610	13000 2930	1.91	104000 23400			LM104949	LM104911A
50.800 2.0000	82.931 3.2650	21.590 0.8500	96300 21700	0.31	1.97	25000 5610	13000 2930	1.91	104000 23400			LM104949	LM104912
50.800 2.0000	83.312 3.2800	17.462 0.6875	54700 12300	0.41	1.48	14200 3190	9840 2210	1.44	67500 15200			18790	18721
50.800 2.0000	85.000 3.3465	17.462 0.6875	54700 12300	0.41	1.48	14200 3190	9840 2210	1.44	67500 15200			18790	18720

<sup>(1)</sup>Based on 1 x 10<sup>6</sup> revolutions L<sub>10</sub> life, for the ISO life-calculation method.

<sup>(2)</sup>Consult your Timken engineer for instructions on use or review the Timken Engineering Manual on timken.com/catalogs.

<sup>(3)</sup>Based on 90 x 10<sup>6</sup> revolutions L<sub>10</sub> life, for The Timken Company life-calculation method. C<sub>90</sub> and C<sub>a90</sub> are radial and thrust values.

Bearing Dimensions											Geometry Factors			Bearing Weight
Width B	Width C	Eff. Ctr. a <sup>(4)</sup>	Shaft			Housing			Cage		G <sub>1</sub>	G <sub>2</sub>	C <sub>g</sub>	
			Max Shaft Fillet Radius R <sup>(5)</sup>	Backing Shoulder Dia. d <sub>a</sub> d <sub>b</sub>		Max Housing Fillet Radius r <sup>(5)</sup>	Backing Shoulder Dia. D <sub>a</sub> D <sub>b</sub>		A <sub>a</sub> <sup>(6)</sup>	A <sub>b</sub> <sup>(7)</sup>				
mm in.	mm in.	mm in.	mm in.	mm in.	mm in.	mm in.	mm in.	mm in.	mm in.	mm in.				kg lbs.
22.225 0.8750	20.000 0.7874	-4.3 -0.17	2.3 0.09	55.0 2.17	59.0 2.32	0.8 0.03	84.7 3.34	82.0 3.23	0.4 0.01	1.1 0.04	33.8	14.0	0.0773	0.56 1.24
22.225 0.8750	20.000 0.7874	-4.3 -0.17	2.0 0.08	55.0 2.17	58.0 2.28	0.8 0.03	84.7 3.34	82.0 3.23	0.4 0.01	1.1 0.04	33.8	14.0	0.0773	0.56 1.24
22.225 0.8750	15.875 0.6250	-4.3 -0.17	2.0 0.08	55.0 2.17	58.0 2.28	2.0 0.08	84.0 3.31	81.0 3.19	0.4 0.01	1.1 0.04	33.8	14.0	0.0773	0.53 1.16
28.000 1.1024	23.000 0.9055	-7.6 -0.30	3.0 0.12	57.0 2.24	63.0 2.48	2.5 0.10	85.0 3.35	80.0 3.15	0.8 0.03	2.3 0.09	48.2	15.2	0.0885	0.74 1.64
28.000 1.1024	23.000 0.9055	-7.6 -0.30	5.0 0.20	57.0 2.24	67.0 2.64	2.5 0.10	85.0 3.35	80.0 3.15	0.8 0.03	2.3 0.09	48.2	15.2	0.0885	0.74 1.63
28.000 1.1024	23.000 0.9055	-7.6 -0.30	3.0 0.12	57.0 2.24	63.0 2.48	0.8 0.03	85.0 3.35	81.0 3.19	0.8 0.03	2.3 0.09	48.2	15.2	0.0885	0.74 1.64
28.000 1.1024	23.000 0.9055	-7.6 -0.30	2.5 0.10	57.0 2.24	63.0 2.48	2.5 0.10	85.0 3.35	80.0 3.15	0.8 0.03	2.3 0.09	48.2	15.2	0.0885	0.74 1.64
29.000 1.1417	22.000 0.8661	4.3 0.17	3.0 0.12	60.0 2.36	76.0 2.99	3.0 0.12	100.0 3.94	86.0 3.39	4.9 0.19	3.6 0.15	39.0	14.6	0.1105	1.23 2.72
36.000 1.4173	29.000 1.1417	-7.6 -0.30	3.0 0.12	63.0 2.48	69.0 2.72	2.5 0.10	100.0 3.94	90.0 3.54	3.5 0.14	2.6 0.11	63.9	17.1	0.0760	1.50 3.28
12.700 0.5000	9.525 0.3750	0.0 0.00	1.5 0.06	55.0 2.17	57.0 2.24	1.5 0.06	74.0 2.91	71.0 2.80	0.2 0.00	1.7 0.07	24.2	29.1	0.0699	0.20 0.44
18.258 0.7188	14.288 0.5625	-2.5 -0.10	1.5 0.06	56.0 2.20	58.0 2.28	1.5 0.06	77.0 3.03	73.0 2.87	0.2 0.01	2.0 0.08	38.8	29.8	0.0841	0.35 0.77
22.225 0.8750	17.000 0.6693	-5.8 -0.23	3.5 0.14	56.0 2.20	63.0 2.48	0.5 0.02	78.0 3.07	76.0 2.99	1.1 0.04	2.0 0.08	38.8	19.3	0.0801	0.42 0.93
22.225 0.8750	16.510 0.6500	-5.8 -0.23	3.5 0.14	56.0 2.20	63.0 2.48	1.3 0.05	78.0 3.07	75.0 2.95	1.1 0.04	2.0 0.08	38.8	19.3	0.0801	0.42 0.93
22.225 0.8750	18.542 0.7300	-5.8 -0.23	3.5 0.14	56.0 2.20	63.0 2.48	0.8 0.03	78.0 3.07	75.0 2.95	1.1 0.04	2.0 0.08	38.8	19.3	0.0801	0.45 0.99
22.225 0.8750	16.510 0.6500	-5.8 -0.23	3.5 0.14	56.0 2.20	63.0 2.48	1.3 0.05	78.0 3.06	75.0 2.95	1.1 0.04	2.0 0.08	38.8	19.3	0.0801	0.43 0.95
17.462 0.6875	13.495 0.5313	-0.8 -0.03	3.5 0.14	56.0 2.20	62.0 2.44	0.8 0.03	79.0 3.11	77.0 3.03	0.8 0.03	1.6 0.07	28.6	23.4	0.0789	0.34 0.76
17.462 0.6875	13.495 0.5313	-0.8 -0.03	3.5 0.14	56.0 2.20	62.0 2.44	1.5 0.06	80.0 3.15	77.0 3.03	0.8 0.03	1.6 0.07	28.6	23.4	0.0789	0.36 0.81

<sup>(4)</sup>Negative value indicates effective center inside cone (inner-ring) backface.

<sup>(5)</sup>These maximum fillet radii will be cleared by the bearing corners.

<sup>(6)</sup>Negative value indicates cage extends beyond cone (inner-ring) backface.

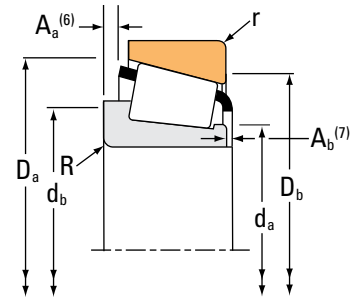
<sup>(7)</sup>Negative value indicates cage that does not extend beyond cone (inner-ring) front face.

Continued on next page.

# TAPERED ROLLER BEARINGS

## SINGLE-ROW • TYPE TS

### TYPE TS



Bearing Dimensions			Load Ratings							Part Number			
Bore d	O.D. D	Width T	Dynamic <sup>(1)</sup>		Factors <sup>(2)</sup>		Dynamic <sup>(3)</sup>		Factors <sup>(2)</sup>		Static C <sub>0</sub>	Inner	Outer
			C <sub>1</sub>	e	Y	C <sub>90</sub>	C <sub>a90</sub>	K	N	N			
mm in.	mm in.	mm in.	N lbf			N lbf	N lbf		N lbf				
50.800 2.0000	85.725 3.3750	19.050 0.7500	61100 13700	0.57	1.06	15800 3560	15400 3470	1.03	63900 14400		18200	18337	
50.800 2.0000	88.900 3.5000	17.462 0.6875	54700 12300	0.41	1.48	14200 3190	9840 2210	1.44	67500 15200		18790	18724	
50.800 2.0000	88.900 3.5000	20.638 0.8125	102000 22900	0.32	1.88	26400 5930	14400 3250	1.83	95800 21500		368A	362A	
50.800 2.0000	88.900 3.5000	20.638 0.8125	102000 22900	0.32	1.88	26400 5930	14400 3250	1.83	95800 21500		368	362A	
50.800 2.0000	88.900 3.5000	20.638 0.8125	54700 12300	0.41	1.48	14200 3190	9840 2210	1.44	67500 15200		18790	18723	
50.800 2.0000	88.900 3.5000	20.638 0.8125	102000 22900	0.32	1.88	26400 5930	14400 3250	1.83	95800 21500		370A	362A	
50.800 2.0000	88.900 3.5000	23.812 0.9375	102000 22900	0.32	1.88	26400 5930	14400 3250	1.83	95800 21500		368A	362AX	
50.800 2.0000	89.980 3.5425	24.750 0.9744	98900 22200	0.38	1.59	25700 5770	16600 3720	1.55	130000 29200		28580	28520	
50.800 2.0000	90.000 3.5433	20.000 0.7874	102000 22900	0.32	1.88	26400 5930	14400 3250	1.83	95800 21500		368	362	
50.800 2.0000	90.000 3.5433	20.000 0.7874	102000 22900	0.32	1.88	26400 5930	14400 3250	1.83	95800 21500		368A	362	
50.800 2.0000	90.000 3.5433	20.000 0.7874	102000 22900	0.32	1.88	26400 5930	14400 3250	1.83	95800 21500		368	363	
50.800 2.0000	90.000 3.5433	20.000 0.7874	102000 22900	0.32	1.88	26400 5930	14400 3250	1.83	95800 21500		370A	362	
50.800 2.0000	92.075 3.6250	24.608 0.9688	98900 22200	0.38	1.59	25700 5770	16600 3720	1.55	130000 29200		28580	28521	
50.800 2.0000	92.075 3.6250	27.780 1.0937	98900 22200	0.38	1.59	25700 5770	16600 3720	1.55	130000 29200		28580	28523	
50.800 2.0000	93.264 3.6718	20.638 0.8125	104000 23400	0.34	1.77	27000 6070	15700 3520	1.73	101000 22700		375	374	
50.800 2.0000	93.264 3.6718	20.638 0.8125	104000 23400	0.34	1.77	27000 6070	15700 3520	1.73	101000 22700		375-S	374	
50.800 2.0000	93.264 3.6718	26.988 1.0625	104000 23400	0.34	1.77	27000 6070	15700 3520	1.73	101000 22700		375	3720	

<sup>(1)</sup>Based on 1 x 10<sup>6</sup> revolutions L<sub>10</sub> life, for the ISO life-calculation method.

<sup>(2)</sup>Consult your Timken engineer for instructions on use or review the Timken Engineering Manual on timken.com/catalogs.

<sup>(3)</sup>Based on 90 x 10<sup>6</sup> revolutions L<sub>10</sub> life, for The Timken Company life-calculation method. C<sub>90</sub> and C<sub>a90</sub> are radial and thrust values.

Bearing Dimensions											Geometry Factors			Bearing Weight
Width B	Width C	Eff. Ctr. a <sup>(4)</sup>	Shaft			Housing			Cage		G <sub>1</sub>	G <sub>2</sub>	C <sub>g</sub>	
			Max Shaft Fillet Radius R <sup>(5)</sup>	Backing Shoulder Dia. d <sub>a</sub> d <sub>b</sub>		Max Housing Fillet Radius r <sup>(5)</sup>	Backing Shoulder Dia. D <sub>a</sub> D <sub>b</sub>		A <sub>a</sub> <sup>(6)</sup>	A <sub>b</sub> <sup>(7)</sup>				
mm in.	mm in.	mm in.	mm in.	mm in.	mm in.	mm in.	mm in.	mm in.	mm in.	mm in.				kg lbs.
18.263 0.7190	12.700 0.5000	2.0 0.08	1.5 0.06	56.0 2.20	59.0 2.32	1.5 0.06	81.0 3.19	76.0 2.99	* *	* *	26.1	22.1	0.0852	0.39 0.87
17.462 0.6875	13.495 0.5313	-0.8 -0.03	3.5 0.14	56.0 2.20	62.0 2.44	1.3 0.05	82.0 3.23	78.0 3.07	0.8 0.03	1.6 0.07	28.6	23.4	0.0789	0.42 0.93
22.225 0.8750	16.513 0.6501	-4.3 -0.17	3.5 0.14	56.0 2.20	62.0 2.44	1.3 0.05	84.0 3.31	81.0 3.19	0.4 0.01	1.1 0.05	33.8	14.0	0.0773	0.51 1.11
22.225 0.8750	16.513 0.6501	-4.3 -0.17	1.5 0.06	56.0 2.20	58.0 2.28	1.3 0.05	84.0 3.31	81.0 3.19	0.4 0.01	1.1 0.04	33.8	14.0	0.0773	0.51 1.12
17.462 0.6875	16.670 0.6563	-0.8 -0.03	3.5 0.14	56.0 2.20	62.0 2.44	1.3 0.05	82.0 3.23	78.0 3.07	0.8 0.03	1.6 0.07	28.6	23.4	0.0789	0.48 1.06
22.225 0.8750	16.513 0.6501	-4.3 -0.17	5.0 0.20	56.0 2.20	65.0 2.56	1.3 0.05	84.0 3.31	81.0 3.19	0.4 0.01	1.1 0.04	33.8	14.0	0.0773	0.50 1.09
22.225 0.8750	19.688 0.7751	-4.3 -0.17	3.5 0.14	56.0 2.20	62.0 2.44	1.3 0.05	84.0 3.31	80.0 3.15	0.4 0.01	1.1 0.05	33.8	14.0	0.0773	0.55 1.21
25.400 1.0000	19.987 0.7869	-4.8 -0.19	3.5 0.14	57.0 2.24	63.0 2.48	2.3 0.09	86.0 3.39	81.0 3.19	1.4 0.05	1.1 0.05	46.4	18.9	0.0912	0.66 1.45
22.225 0.8750	15.875 0.6250	-4.3 -0.17	1.5 0.06	56.0 2.20	58.0 2.28	2.0 0.08	84.0 3.31	81.0 3.19	0.4 0.01	1.1 0.04	33.8	14.0	0.0773	0.51 1.14
22.225 0.8750	15.875 0.6250	-4.3 -0.17	3.5 0.14	56.0 2.20	62.0 2.44	2.0 0.08	84.0 3.31	81.0 3.19	0.4 0.01	1.1 0.05	33.8	14.0	0.0773	0.51 1.12
22.225 0.8750	20.000 0.7874	-4.3 -0.17	1.5 0.06	56.0 2.20	58.0 2.28	0.8 0.03	84.7 3.34	82.0 3.23	0.4 0.01	1.1 0.04	33.8	14.0	0.0773	0.54 1.21
22.225 0.8750	15.875 0.6250	-4.3 -0.17	5.0 0.20	56.0 2.20	65.0 2.56	2.0 0.08	84.0 3.31	81.0 3.19	0.4 0.01	1.1 0.04	33.8	14.0	0.0773	0.50 1.10
25.400 1.0000	19.845 0.7813	-4.8 -0.19	3.5 0.14	57.0 2.24	63.0 2.48	0.8 0.03	87.0 3.43	83.0 3.27	1.4 0.05	1.1 0.05	46.4	18.9	0.0912	0.70 1.55
25.400 1.0000	23.017 0.9062	-4.8 -0.19	3.5 0.14	57.0 2.24	63.0 2.48	2.3 0.09	87.0 3.43	81.0 3.19	1.4 0.05	1.1 0.05	46.4	18.9	0.0912	0.76 1.67
22.225 0.8750	15.083 0.5938	-3.8 -0.15	2.3 0.09	57.0 2.24	60.0 2.36	1.3 0.05	88.0 3.46	85.0 3.35	0.8 0.03	1.5 0.06	37.6	15.4	0.0816	0.59 1.31
22.225 0.8750	15.083 0.5938	-3.8 -0.15	3.5 0.14	57.0 2.24	63.0 2.48	1.3 0.05	88.0 3.46	85.0 3.35	0.8 0.03	1.5 0.06	37.6	15.4	0.0816	0.59 1.30
22.225 0.8750	23.812 0.9375	-3.8 -0.15	2.3 0.09	57.0 2.24	60.0 2.36	3.3 0.13	87.9 3.46	82.0 3.23	0.8 0.03	1.5 0.06	37.6	15.4	0.0816	0.71 1.57

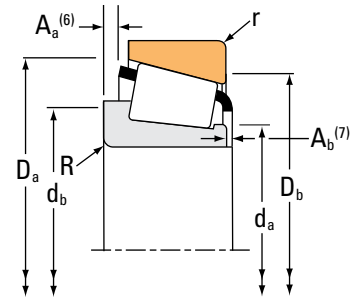
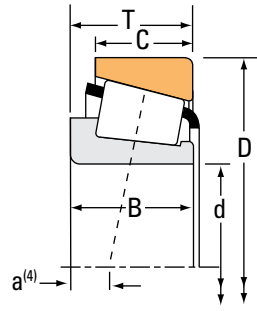
(4) Negative value indicates effective center inside cone (inner-ring) backface.  
 (5) These maximum fillet radii will be cleared by the bearing corners.  
 (6) Negative value indicates cage extends beyond cone (inner-ring) backface.  
 (7) Negative value indicates cage that does not extend beyond cone (inner-ring) front face.  
 (\*) Contact your Timken engineer for details.

Continued on next page.

# TAPERED ROLLER BEARINGS

## SINGLE-ROW • TYPE TS

### TYPE TS



Bearing Dimensions			Load Ratings							Part Number			
Bore d	O.D. D	Width T	Dynamic <sup>(1)</sup>		Factors <sup>(2)</sup>		Dynamic <sup>(3)</sup>		Factors <sup>(2)</sup>		Static C <sub>0</sub>	Inner	Outer
			C <sub>1</sub>	e	Y	C <sub>90</sub>	C <sub>a90</sub>	K	N	N			
mm in.	mm in.	mm in.	N lbf			N lbf	N lbf		N lbf				
50.800 2.0000	93.264 3.6718	26.988 1.0625	104000 23400	0.34	1.77	27000 6070	15700 3520	1.73	101000 22700			375	3730
50.800 2.0000	93.264 3.6718	30.162 1.1875	122000 27500	0.34	1.77	31700 7120	18300 4120	1.73	153000 34300			3780	3720
50.800 2.0000	93.264 3.6718	30.162 1.1875	122000 27500	0.34	1.77	31700 7120	18300 4120	1.73	153000 34300			3775	3720
50.800 2.0000	93.264 3.6718	30.162 1.1875	122000 27500	0.34	1.77	31700 7120	18300 4120	1.73	153000 34300			3784	3720
50.800 2.0000	93.264 3.6718	30.162 1.1875	122000 27500	0.34	1.77	31700 7120	18300 4120	1.73	153000 34300			3780	3730
50.800 2.0000	93.662 3.6875	30.162 1.1875	122000 27500	0.34	1.77	31700 7120	18300 4120	1.73	153000 34300			3784	3727
50.800 2.0000	95.250 3.7500	27.783 1.0938	130000 29200	0.33	1.82	33600 7560	19000 4270	1.77	161000 36200			33889	33821
50.800 2.0000	95.250 3.7500	27.783 1.0938	130000 29200	0.33	1.82	33600 7560	19000 4270	1.77	161000 36200			33889	33822
50.800 2.0000	95.250 3.7500	30.162 1.1875	122000 27500	0.34	1.77	31700 7120	18300 4120	1.73	153000 34300			3780	3726
50.800 2.0000	96.838 3.8125	21.000 0.8268	108000 24200	0.35	1.69	28000 6280	16900 3810	1.65	107000 24100			385A	382A
50.800 2.0000	96.838 3.8125	22.225 0.8750	104000 23400	0.34	1.77	27000 6070	15700 3520	1.73	101000 22700			375-S	372A
50.800 2.0000	96.838 3.8125	22.225 0.8750	104000 23400	0.34	1.77	27000 6070	15700 3520	1.73	101000 22700			375	372A
50.800 2.0000	96.838 3.8125	25.400 1.0000	108000 24200	0.35	1.69	28000 6280	16900 3810	1.65	107000 24100			385A	382-S
50.800 2.0000	98.425 3.8750	21.000 0.8268	108000 24200	0.35	1.69	28000 6280	16900 3810	1.65	107000 24100			385A	382
50.800 2.0000	98.425 3.8750	30.162 1.1875	122000 27500	0.34	1.77	31700 7120	18300 4120	1.73	153000 34300			3780	3732
50.800 2.0000	100.000 3.9370	21.000 0.8268	108000 24200	0.35	1.69	28000 6280	16900 3810	1.65	107000 24100			385A	383A
50.800 2.0000	100.000 3.9370	24.999 0.9842	104000 23400	0.34	1.77	27000 6070	15700 3520	1.73	101000 22700			375	372

<sup>(1)</sup>Based on 1 x 10<sup>6</sup> revolutions L<sub>10</sub> life, for the ISO life-calculation method.

<sup>(2)</sup>Consult your Timken engineer for instructions on use or review the Timken Engineering Manual on timken.com/catalogs.

<sup>(3)</sup>Based on 90 x 10<sup>6</sup> revolutions L<sub>10</sub> life, for The Timken Company life-calculation method. C<sub>90</sub> and C<sub>a90</sub> are radial and thrust values.



Bearing Dimensions											Geometry Factors			Bearing Weight
Width B	Width C	Eff. Ctr. a <sup>(4)</sup>	Shaft			Housing			Cage		G <sub>1</sub>	G <sub>2</sub>	C <sub>g</sub>	
			Max Shaft Fillet Radius R <sup>(5)</sup>	Backing Shoulder Dia. d <sub>a</sub>	Backing Shoulder Dia. d <sub>b</sub>	Max Housing Fillet Radius r <sup>(5)</sup>	Backing Shoulder Dia. D <sub>a</sub>	Backing Shoulder Dia. D <sub>b</sub>	A <sub>a</sub> <sup>(6)</sup>	A <sub>b</sub> <sup>(7)</sup>				
mm in.	mm in.	mm in.	mm in.	mm in.	mm in.	mm in.	mm in.	mm in.	mm in.	mm in.				kg lbs.
22.225 0.8750	23.812 0.9375	-3.8 -0.15	2.3 0.09	57.0 2.24	60.0 2.36	0.8 0.03	88.0 3.46	84.0 3.31	0.8 0.03	1.5 0.06	37.6	15.4	0.0816	0.72 1.58
30.302 1.1930	23.812 0.9375	-8.1 -0.32	3.5 0.14	58.0 2.28	64.0 2.52	3.3 0.13	87.9 3.46	82.0 3.23	1.8 0.07	1.0 0.04	49.9	14.5	0.0903	0.85 1.87
30.302 1.1930	23.812 0.9375	-8.1 -0.32	0.8 0.03	58.0 2.28	58.0 2.28	3.3 0.13	87.9 3.46	82.0 3.23	1.8 0.07	1.0 0.04	49.9	14.5	0.0903	0.86 1.89
30.302 1.1930	23.812 0.9375	-8.1 -0.32	6.4 0.25	58.0 2.28	70.0 2.76	3.3 0.13	87.9 3.46	82.0 3.23	1.8 0.07	1.0 0.04	49.9	14.5	0.0903	0.83 1.83
30.302 1.1930	23.812 0.9375	-8.1 -0.32	3.5 0.14	58.0 2.28	64.0 2.52	0.8 0.03	88.0 3.46	84.0 3.31	1.8 0.07	1.0 0.04	49.9	14.5	0.0903	0.86 1.88
30.302 1.1930	23.812 0.9375	-8.1 -0.32	6.4 0.25	58.0 2.28	70.0 2.76	3.3 0.13	87.8 3.46	82.0 3.23	1.8 0.07	1.0 0.04	49.9	14.5	0.0903	0.83 1.84
28.575 1.1250	22.225 0.8750	-7.6 -0.30	3.5 0.14	58.0 2.28	64.0 2.52	2.3 0.09	90.0 3.54	85.0 3.35	1.3 0.05	2.2 0.09	52.5	18.5	0.0910	0.85 1.87
28.575 1.1250	22.225 0.8750	-7.6 -0.30	3.5 0.14	58.0 2.28	64.0 2.52	0.8 0.03	90.0 3.54	86.0 3.39	1.3 0.05	2.2 0.09	52.5	18.5	0.0910	0.86 1.88
30.302 1.1930	23.812 0.9375	-8.1 -0.32	3.5 0.14	58.0 2.28	64.0 2.52	3.3 0.13	88.9 3.50	83.1 3.27	1.8 0.07	1.0 0.04	49.9	14.5	0.0903	0.90 1.98
21.946 0.8640	15.875 0.6250	-3.0 -0.12	2.3 0.09	60.0 2.36	61.0 2.40	0.8 0.03	92.0 3.62	89.0 3.50	1.1 0.04	2.0 0.08	42.0	15.7	0.0859	0.68 1.51
22.225 0.8750	19.050 0.7500	-3.8 -0.15	3.5 0.14	57.0 2.24	63.0 2.48	1.5 0.06	90.0 3.54	86.0 3.39	0.8 0.03	1.5 0.06	37.6	15.4	0.0816	0.71 1.56
22.225 0.8750	19.050 0.7500	-3.8 -0.15	2.3 0.09	57.0 2.24	60.0 2.36	1.5 0.06	90.0 3.54	86.0 3.39	0.8 0.03	1.5 0.06	37.6	15.4	0.0816	0.71 1.57
21.946 0.8640	20.274 0.7982	-3.0 -0.12	2.3 0.09	60.0 2.36	61.0 2.40	2.3 0.09	91.0 3.58	87.0 3.43	1.1 0.04	2.0 0.08	42.0	15.7	0.0859	0.75 1.66
21.946 0.8640	17.826 0.7018	-3.0 -0.12	2.3 0.09	60.0 2.36	61.0 2.40	0.8 0.03	92.0 3.62	90.0 3.54	1.1 0.04	2.0 0.08	42.0	15.7	0.0859	0.73 1.61
30.302 1.1930	23.812 0.9375	-8.1 -0.32	3.5 0.14	58.0 2.28	64.0 2.52	3.3 0.13	89.9 3.54	84.1 3.31	1.8 0.07	1.0 0.04	49.9	14.5	0.0903	0.99 2.17
21.946 0.8640	17.826 0.7018	-3.0 -0.12	2.3 0.09	60.0 2.36	61.0 2.40	2.0 0.08	93.0 3.66	89.0 3.50	1.1 0.04	2.0 0.08	42.0	15.7	0.0859	0.76 1.68
22.225 0.8750	21.824 0.8592	-3.8 -0.15	2.3 0.09	57.0 2.24	60.0 2.36	2.0 0.08	90.0 3.54	86.0 3.39	0.8 0.03	1.5 0.06	37.6	15.4	0.0816	0.85 1.88

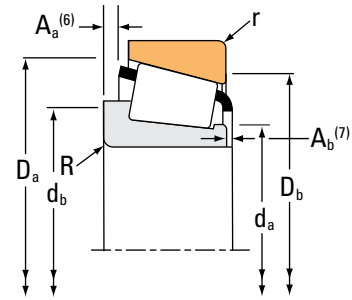
<sup>(4)</sup>Negative value indicates effective center inside cone (inner-ring) backface.  
<sup>(5)</sup>These maximum fillet radii will be cleared by the bearing corners.  
<sup>(6)</sup>Negative value indicates cage extends beyond cone (inner-ring) backface.  
<sup>(7)</sup>Negative value indicates cage that does not extend beyond cone (inner-ring) front face.

Continued on next page.

# TAPERED ROLLER BEARINGS

## SINGLE-ROW • TYPE TS

### TYPE TS



Bearing Dimensions			Load Ratings							Part Number			
Bore d	O.D. D	Width T	Dynamic <sup>(1)</sup>		Factors <sup>(2)</sup>		Dynamic <sup>(3)</sup>		Factors <sup>(2)</sup>		Static C <sub>0</sub>	Inner	Outer
			C <sub>1</sub>	e	Y	C <sub>90</sub>	C <sub>a90</sub>	K	N	N			
mm in.	mm in.	mm in.	N lbf			N lbf	N lbf		N lbf				
50.800 2.0000	100.000 3.9370	25.400 1.0000	108000 24200	0.35	1.69	28000 6280	16900 3810	1.65	107000 24100			385A	383X
50.800 2.0000	100.000 3.9370	34.925 1.3750	165000 37000	0.29	2.10	42700 9600	20800 4690	2.05	191000 43000			529	520X
50.800 2.0000	100.000 3.9370	34.925 1.3750	165000 37000	0.29	2.10	42700 9600	20800 4690	2.05	191000 43000			529X	520X
50.800 2.0000	100.000 3.9370	34.925 1.3750	165000 37000	0.29	2.10	42700 9600	20800 4690	2.05	191000 43000			529X	J520
50.800 2.0000	101.600 4.0000	31.750 1.2500	157000 35400	0.40	1.50	40800 9170	28000 6290	1.46	155000 35000			49585	49520
50.800 2.0000	101.600 4.0000	31.750 1.2500	157000 35400	0.40	1.50	40800 9170	28000 6290	1.46	155000 35000			49585	49522
50.800 2.0000	101.600 4.0000	34.925 1.3750	165000 37000	0.29	2.10	42700 9600	20800 4690	2.05	191000 43000			529	522
50.800 2.0000	101.600 4.0000	34.925 1.3750	165000 37000	0.29	2.10	42700 9600	20800 4690	2.05	191000 43000			529X	522
50.800 2.0000	104.775 4.1250	30.162 1.1875	161000 36100	0.34	1.79	41700 9370	23900 5380	1.74	166000 37200			455	453X
50.800 2.0000	104.775 4.1250	30.162 1.1875	161000 36100	0.34	1.79	41700 9370	23900 5380	1.74	166000 37200			455-S	453X
50.800 2.0000	104.775 4.1250	30.162 1.1875	153000 34500	0.33	1.80	39700 8930	22600 5090	1.76	189000 42600			45285	45220
50.800 2.0000	104.775 4.1250	30.162 1.1875	153000 34500	0.33	1.80	39700 8930	22600 5090	1.76	189000 42600			45284	45220
50.800 2.0000	104.775 4.1250	30.162 1.1875	153000 34500	0.33	1.80	39700 8930	22600 5090	1.76	189000 42600			45285	45221
50.800 2.0000	104.775 4.1250	30.162 1.1875	153000 34500	0.33	1.80	39700 8930	22600 5090	1.76	189000 42600			45285A	45220
50.800 2.0000	104.775 4.1250	30.162 1.1875	153000 34500	0.33	1.80	39700 8930	22600 5090	1.76	189000 42600			45284	45221
50.800 2.0000	104.775 4.1250	30.162 1.1875	153000 34500	0.33	1.80	39700 8930	22600 5090	1.76	189000 42600			45285A	45221
50.800 2.0000	104.775 4.1250	36.512 1.4375	202000 45500	0.40	1.49	52400 11800	36100 8110	1.45	202000 45400			59200	59412

<sup>(1)</sup>Based on 1 x 10<sup>6</sup> revolutions L<sub>10</sub> life, for the ISO life-calculation method.

<sup>(2)</sup>Consult your Timken engineer for instructions on use or review the Timken Engineering Manual on timken.com/catalogs.

<sup>(3)</sup>Based on 90 x 10<sup>6</sup> revolutions L<sub>10</sub> life, for The Timken Company life-calculation method. C<sub>90</sub> and C<sub>a90</sub> are radial and thrust values.

Bearing Dimensions											Geometry Factors			Bearing Weight
Width B	Width C	Eff. Ctr. a <sup>(4)</sup>	Shaft			Housing			Cage		G <sub>1</sub>	G <sub>2</sub>	C <sub>g</sub>	
			Max Shaft Fillet Radius R <sup>(5)</sup>	Backing Shoulder Dia. d <sub>a</sub>	Backing Shoulder Dia. d <sub>b</sub>	Max Housing Fillet Radius r <sup>(5)</sup>	Backing Shoulder Dia. D <sub>a</sub>	Backing Shoulder Dia. D <sub>b</sub>	A <sub>a</sub> <sup>(6)</sup>	A <sub>b</sub> <sup>(7)</sup>				
mm in.	mm in.	mm in.	mm in.	mm in.	mm in.	mm in.	mm in.	mm in.	mm in.	mm in.				kg lbs.
21.946 0.8640	22.225 0.8750	-3.0 -0.12	2.3 0.09	60.0 2.36	61.0 2.40	1.3 0.05	93.0 3.66	89.0 3.50	1.1 0.04	2.0 0.08	42.0	15.7	0.0859	0.85 1.88
36.068 1.4200	26.988 1.0625	-12.7 -0.50	0.8 0.03	60.0 2.36	61.0 2.40	3.3 0.13	94.0 3.70	88.0 3.46	2.7 0.10	1.8 0.07	57.9	13.4	0.0894	1.17 2.61
36.068 1.4200	26.988 1.0625	-12.7 -0.50	3.5 0.14	58.0 2.28	65.0 2.56	3.3 0.13	94.0 3.70	88.0 3.46	2.7 0.10	1.8 0.07	57.9	13.4	0.0894	1.17 2.59
36.068 1.4200	26.988 1.0625	-12.7 -0.50	3.5 0.14	58.0 2.28	65.0 2.56	3.3 0.13	94.0 3.70	88.0 3.46	2.7 0.10	1.8 0.07	57.9	13.4	0.0894	1.19 2.63
31.750 1.2500	25.400 1.0000	-7.1 -0.28	3.5 0.14	59.0 2.32	66.0 2.60	3.3 0.13	96.0 3.78	88.0 3.46	2.3 0.09	1.4 0.06	49.1	16.8	0.0946	1.12 2.46
31.750 1.2500	25.400 1.0000	-7.1 -0.28	3.5 0.14	59.0 2.32	66.0 2.60	0.8 0.03	96.0 3.78	90.0 3.54	2.3 0.09	1.4 0.06	49.1	16.8	0.0946	1.13 2.49
36.068 1.4200	26.988 1.0625	-12.7 -0.50	0.8 0.03	60.0 2.36	61.0 2.40	3.3 0.13	95.0 3.74	89.0 3.50	2.7 0.10	1.8 0.07	57.9	13.4	0.0894	1.23 2.73
36.068 1.4200	26.988 1.0625	-12.7 -0.50	3.5 0.14	58.0 2.28	65.0 2.56	3.3 0.13	95.0 3.74	89.0 3.50	2.7 0.10	1.8 0.07	57.9	13.4	0.0894	1.23 2.71
29.317 1.1542	24.605 0.9687	-7.1 -0.28	0.8 0.03	59.0 2.32	60.0 2.36	3.3 0.13	98.0 3.86	92.0 3.62	2.1 0.08	1.4 0.06	58.6	17.1	0.0946	1.18 2.58
29.317 1.1542	24.605 0.9687	-7.1 -0.28	3.5 0.14	59.0 2.32	65.0 2.56	3.3 0.13	98.0 3.86	92.0 3.62	2.1 0.08	1.4 0.06	58.6	17.1	0.0946	1.17 2.56
30.958 1.2188	23.812 0.9375	-8.1 -0.32	2.3 0.09	59.0 2.32	63.0 2.48	3.3 0.13	99.0 3.90	93.0 3.66	2.1 0.08	1.8 0.07	63.5	16.9	0.0971	1.22 2.68
30.958 1.2188	23.812 0.9375	-8.1 -0.32	6.4 0.25	59.0 2.32	71.0 2.80	3.3 0.13	99.0 3.90	93.0 3.66	2.1 0.08	1.8 0.07	63.5	16.9	0.0971	1.19 2.62
30.958 1.2188	23.812 0.9375	-8.1 -0.32	2.3 0.09	59.0 2.32	63.0 2.48	0.8 0.03	99.0 3.90	95.0 3.74	2.1 0.08	1.8 0.07	63.5	16.9	0.0971	1.22 2.69
30.958 1.2188	23.812 0.9375	-8.1 -0.32	0.8 0.03	59.0 2.32	60.0 2.36	3.3 0.13	99.0 3.90	93.0 3.66	2.1 0.08	1.8 0.07	63.5	16.9	0.0971	1.22 2.68
30.958 1.2188	23.812 0.9375	-8.1 -0.32	6.4 0.25	59.0 2.32	71.0 2.80	0.8 0.03	99.0 3.90	95.0 3.74	2.1 0.08	1.8 0.07	63.5	16.9	0.0971	1.19 2.62
30.958 1.2188	23.812 0.9375	-8.1 -0.32	0.8 0.03	59.0 2.32	60.0 2.36	0.8 0.03	99.0 3.90	95.0 3.74	2.1 0.08	1.8 0.07	63.5	16.9	0.0971	1.22 2.68
36.512 1.4375	28.575 1.1250	-9.7 -0.38	3.5 0.14	61.0 2.40	68.0 2.68	3.3 0.13	99.0 3.90	92.0 3.62	3.4 0.13	1.3 0.05	57.3	15.2	0.0999	1.41 3.09

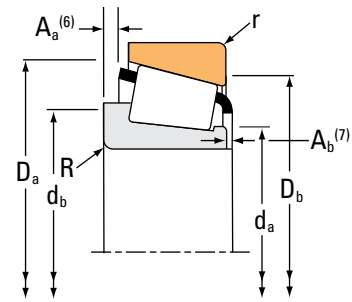
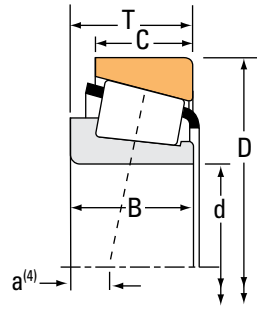
<sup>(4)</sup>Negative value indicates effective center inside cone (inner-ring) backface.  
<sup>(5)</sup>These maximum fillet radii will be cleared by the bearing corners.  
<sup>(6)</sup>Negative value indicates cage extends beyond cone (inner-ring) backface.  
<sup>(7)</sup>Negative value indicates cage that does not extend beyond cone (inner-ring) front face.

Continued on next page.

# TAPERED ROLLER BEARINGS

## SINGLE-ROW • TYPE TS

### TYPE TS



Bearing Dimensions			Load Ratings							Part Number			
Bore d	O.D. D	Width T	Dynamic <sup>(1)</sup>		Factors <sup>(2)</sup>		Dynamic <sup>(3)</sup>		Factors <sup>(2)</sup>		Static C <sub>0</sub>	Inner	Outer
			C <sub>1</sub>	e	Y	C <sub>90</sub>	C <sub>a90</sub>	K	N	N			
mm in.	mm in.	mm in.	N lbf			N lbf	N lbf		N lbf				
50.800 2.0000	104.775 4.1250	36.512 1.4375	202000 45500	0.40	1.49	52400 11800	36100 8110	1.45	202000 45400		59200	59413	
50.800 2.0000	104.775 4.1250	36.512 1.4375	203000 45700	0.49	1.23	52700 11900	44000 9890	1.20	223000 50200		HM807046	HM807010	
50.800 2.0000	104.775 4.1250	36.512 1.4375	203000 45700	0.49	1.23	52700 11900	44000 9890	1.20	223000 50200		HM807046	HM807011	
50.800 2.0000	104.775 4.1250	36.512 1.4375	202000 45500	0.40	1.49	52400 11800	36100 8110	1.45	202000 45400		59201	59412	
50.800 2.0000	104.775 4.1250	39.688 1.5625	180000 40500	0.34	1.79	46800 10500	26800 6030	1.74	237000 53200		4580	4535	
50.800 2.0000	105.000 4.1339	36.873 1.4517	203000 45700	0.49	1.23	52700 11900	44000 9890	1.20	223000 50200		HM807046	JHM807012	
50.800 2.0000	107.950 4.2500	27.783 1.0938	161000 36100	0.34	1.79	41700 9370	23900 5380	1.74	166000 37200		455	453A	
50.800 2.0000	107.950 4.2500	27.783 1.0938	161000 36100	0.34	1.79	41700 9370	23900 5380	1.74	166000 37200		455-S	453A	
50.800 2.0000	107.950 4.2500	27.795 1.0943	161000 36100	0.34	1.79	41700 9370	23900 5380	1.74	166000 37200		455	453	
50.800 2.0000	107.950 4.2500	36.512 1.4375	202000 45500	0.40	1.49	52400 11800	36100 8110	1.45	202000 45400		59200	59425	
50.800 2.0000	110.000 4.3307	27.795 1.0943	161000 36100	0.34	1.79	41700 9370	23900 5380	1.74	166000 37200		455	454	
50.800 2.0000	111.125 4.3750	30.162 1.1875	126000 28300	0.88	0.68	32700 7350	49500 11100	0.66	119000 26700		55200	55437	
50.800 2.0000	111.125 4.3750	30.162 1.1875	123000 27700	0.88	0.68	31900 7170	48200 10800	0.66	153000 34400		HM907643	HM907614	
50.800 2.0000	111.125 4.3750	30.162 1.1875	151000 34000	0.88	0.68	39200 8810	59300 13300	0.66	161000 36200		55200C	55437	
50.800 2.0000	111.125 4.3750	38.108 1.5003	161000 36100	0.34	1.79	41700 9370	23900 5380	1.74	166000 37200		455	4536	
50.800 2.0000	111.125 4.3750	38.108 1.5003	161000 36100	0.34	1.79	41700 9370	23900 5380	1.74	166000 37200		455-S	4536	
50.800 2.0000	112.712 4.4375	30.162 1.1875	126000 28300	0.88	0.68	32700 7350	49500 11100	0.66	119000 26700		55200	55443	

<sup>(1)</sup>Based on 1 x 10<sup>6</sup> revolutions L<sub>10</sub> life, for the ISO life-calculation method.

<sup>(2)</sup>Consult your Timken engineer for instructions on use or review the Timken Engineering Manual on timken.com/catalogs.

<sup>(3)</sup>Based on 90 x 10<sup>6</sup> revolutions L<sub>10</sub> life, for The Timken Company life-calculation method. C<sub>90</sub> and C<sub>a90</sub> are radial and thrust values.

Bearing Dimensions											Geometry Factors			Bearing Weight
Width B	Width C	Eff. Ctr. a <sup>(4)</sup>	Shaft			Housing			Cage		G <sub>1</sub>	G <sub>2</sub>	C <sub>g</sub>	
			Max Shaft Fillet Radius R <sup>(5)</sup>	Backing Shoulder Dia. d <sub>a</sub>	Shoulder Dia. d <sub>b</sub>	Max Housing Fillet Radius r <sup>(5)</sup>	Backing Shoulder Dia. D <sub>a</sub>	Shoulder Dia. D <sub>b</sub>	A <sub>a</sub> <sup>(6)</sup>	A <sub>b</sub> <sup>(7)</sup>				
mm in.	mm in.	mm in.	mm in.	mm in.	mm in.	mm in.	mm in.	mm in.	mm in.	mm in.				kg lbs.
36.512 1.4375	28.575 1.1250	-9.7 -0.38	3.5 0.14	61.0 2.40	68.0 2.68	0.8 0.03	102.0 4.02	87.0 3.43	3.4 0.13	1.3 0.05	57.3	15.2	0.0999	1.42 3.12
36.512 1.4375	28.575 1.1250	-7.4 -0.29	3.5 0.14	63.1 2.48	70.0 2.76	3.3 0.13	100.0 3.94	89.0 3.50	3.4 0.13	2.0 0.08	63.9	17.1	0.0760	1.47 3.24
36.512 1.4375	28.575 1.1250	-7.4 -0.29	3.5 0.14	63.1 2.48	70.0 2.76	0.8 0.03	100.0 3.94	91.0 3.58	3.4 0.13	2.0 0.08	63.9	17.1	0.0760	1.47 3.24
36.512 1.4375	28.575 1.1250	-9.7 -0.38	0.8 0.03	61.0 2.40	62.0 2.44	3.3 0.13	99.0 3.90	92.0 3.62	3.4 0.13	1.3 0.05	57.3	15.2	0.0999	1.42 3.11
40.157 1.5810	33.338 1.3125	-12.4 -0.49	3.5 0.14	61.0 2.40	67.0 2.64	3.3 0.13	99.0 3.90	90.0 3.54	1.6 0.06	1.3 0.05	73.6	20.2	0.1027	1.62 3.58
36.512 1.4375	29.000 1.1417	-7.4 -0.29	3.5 0.14	63.1 2.48	70.0 2.76	2.5 0.10	100.0 3.94	90.0 3.54	3.4 0.13	2.0 0.08	63.9	17.1	0.0760	1.49 3.27
29.317 1.1542	22.225 0.8750	-7.1 -0.28	0.8 0.03	59.0 2.32	60.0 2.36	0.8 0.03	100.0 3.94	97.0 3.82	2.1 0.08	1.4 0.06	58.6	17.1	0.0946	1.23 2.70
29.317 1.1542	22.225 0.8750	-7.1 -0.28	3.5 0.14	59.0 2.32	65.0 2.56	0.8 0.03	100.0 3.94	97.0 3.82	2.1 0.08	1.4 0.06	58.6	17.1	0.0946	1.22 2.69
29.317 1.1542	27.000 1.0630	-7.1 -0.28	0.8 0.03	59.0 2.32	60.0 2.36	0.8 0.03	100.0 3.94	97.0 3.82	2.1 0.08	1.4 0.06	58.6	17.1	0.0946	1.29 2.83
36.512 1.4375	28.575 1.1250	-9.7 -0.38	3.5 0.14	61.0 2.40	68.0 2.68	3.3 0.13	101.0 3.98	93.0 3.66	3.4 0.13	1.3 0.05	57.3	15.2	0.0999	1.52 3.35
29.317 1.1542	27.000 1.0630	-7.1 -0.28	0.8 0.03	59.0 2.32	60.0 2.36	2.0 0.08	100.0 3.94	96.0 3.78	2.1 0.08	1.4 0.06	58.6	17.1	0.0946	1.36 2.98
26.909 1.0594	20.638 0.8125	7.1 0.28	3.5 0.14	63.9 2.51	71.0 2.80	3.3 0.13	105.0 4.13	92.0 3.62	4.8 0.18	3.2 0.13	36.8	13.2	0.1085	1.26 2.79
28.575 1.1250	20.638 0.8125	7.6 0.30	3.5 0.14	65.3 2.56	74.0 2.91	3.3 0.13	105.0 4.13	91.0 3.58	4.6 0.18	2.1 0.08	46.9	17.5	0.1182	1.35 2.96
26.909 1.0594	20.638 0.8125	7.6 0.30	3.5 0.14	64.4 2.54	71.0 2.80	3.3 0.13	105.0 4.13	92.0 3.62	5.0 0.19	3.7 0.15	48.7	18.1	0.1198	1.36 2.98
29.317 1.1542	32.545 1.2813	-7.1 -0.28	0.8 0.03	59.0 2.32	60.0 2.36	3.3 0.13	100.0 3.94	93.0 3.66	2.1 0.08	1.4 0.06	58.6	17.1	0.0946	1.64 3.59
29.317 1.1542	32.545 1.2813	-7.1 -0.28	3.5 0.14	59.0 2.32	65.0 2.56	3.3 0.13	100.0 3.94	93.0 3.66	2.1 0.08	1.4 0.06	58.6	17.1	0.0946	1.63 3.58
26.909 1.0594	20.638 0.8125	7.1 0.28	3.5 0.14	63.9 2.51	71.0 2.80	3.3 0.13	106.0 4.17	92.0 3.62	4.8 0.18	3.2 0.13	36.8	13.2	0.1085	1.29 2.87

<sup>(4)</sup>Negative value indicates effective center inside cone (inner-ring) backface.

<sup>(5)</sup>These maximum fillet radii will be cleared by the bearing corners.

<sup>(6)</sup>Negative value indicates cage extends beyond cone (inner-ring) backface.

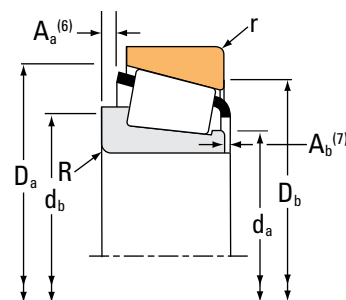
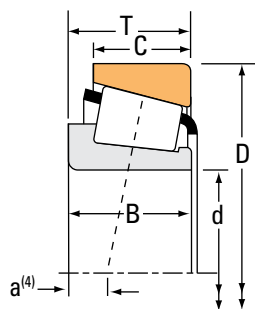
<sup>(7)</sup>Negative value indicates cage that does not extend beyond cone (inner-ring) front face.

Continued on next page.

# TAPERED ROLLER BEARINGS

## SINGLE-ROW • TYPE TS

### TYPE TS



Bearing Dimensions			Load Ratings							Part Number		
Bore d	O.D. D	Width T	Dynamic <sup>(1)</sup>		Factors <sup>(2)</sup>		Dynamic <sup>(3)</sup>		Factors <sup>(2)</sup>	Static	Inner	Outer
			C <sub>1</sub>	e	Y	C <sub>90</sub>	C <sub>a90</sub>	K	C <sub>0</sub>			
mm in.	mm in.	mm in.	N lbf			N lbf	N lbf		N lbf			
50.800 2.0000	112.712 4.4375	30.162 1.1875	167000 37500	0.34	1.77	43300 9730	25100 5650	1.72	224000 50300		39575	39520
50.800 2.0000	112.712 4.4375	30.162 1.1875	167000 37500	0.34	1.77	43300 9730	25100 5650	1.72	224000 50300		39573	39521
50.800 2.0000	112.712 4.4375	30.162 1.1875	167000 37500	0.34	1.77	43300 9730	25100 5650	1.72	224000 50300		39573	39520
50.800 2.0000	112.712 4.4375	30.162 1.1875	167000 37500	0.34	1.77	43300 9730	25100 5650	1.72	224000 50300		39575	39521
50.800 2.0000	114.300 4.5000	44.450 1.7500	224000 50300	0.43	1.39	58000 13000	42700 9600	1.36	256000 57500		65395	65320
50.800 2.0000	117.475 4.6250	33.338 1.3125	177000 39700	0.63	0.96	45800 10300	49100 11000	0.93	166000 37300		66200	66462
50.800 2.0000	120.650 4.7500	41.275 1.6250	207000 46600	0.31	1.91	53800 12100	28900 6510	1.86	244000 54800		619	612
50.800 2.0000	122.238 4.8125	43.658 1.7188	237000 53200	0.36	1.67	61300 13800	37600 8460	1.63	327000 73500		5565	5535
50.800 2.0000	123.825 4.8750	36.512 1.4375	214000 48200	0.74	0.81	55500 12500	70100 15800	0.79	208000 46800		72200C	72487
50.800 2.0000	123.825 4.8750	36.512 1.4375	214000 48200	0.74	0.81	55500 12500	70100 15800	0.79	208000 46800		72201C	72487
50.800 2.0000	123.825 4.8750	38.100 1.5000	191000 42900	0.35	1.73	49400 11100	29300 6590	1.69	248000 55700		555	552A
50.800 2.0000	123.825 4.8750	38.100 1.5000	191000 42900	0.35	1.73	49400 11100	29300 6590	1.69	248000 55700		555	552
50.800 2.0000	127.000 5.0000	36.512 1.4375	229000 51500	0.50	1.20	59400 13400	51100 11500	1.16	256000 57600		HM813836	HM813810
50.800 2.0000	127.000 5.0000	44.450 1.7500	243000 54700	0.49	1.23	63100 14200	52700 11800	1.20	297000 66700		65200	65500
50.800 2.0000	127.000 5.0000	50.800 2.0000	306000 68800	0.30	2.01	79300 17800	40500 9110	1.96	370000 83300		6279	6220
51.592 2.0312	88.900 3.5000	20.638 0.8125	102000 22900	0.32	1.88	26400 5930	14400 3250	1.83	95800 21500		368-S	362A
51.592 2.0312	90.000 3.5433	20.000 0.7874	102000 22900	0.32	1.88	26400 5930	14400 3250	1.83	95800 21500		368-S	362

<sup>(1)</sup>Based on 1 x 10<sup>6</sup> revolutions L<sub>10</sub> life, for the ISO life-calculation method.

<sup>(2)</sup>Consult your Timken engineer for instructions on use or review the Timken Engineering Manual on timken.com/catalogs.

<sup>(3)</sup>Based on 90 x 10<sup>6</sup> revolutions L<sub>10</sub> life, for The Timken Company life-calculation method. C<sub>90</sub> and C<sub>a90</sub> are radial and thrust values.

Bearing Dimensions											Geometry Factors			Bearing Weight
Width B	Width C	Eff. Ctr. a <sup>(4)</sup>	Shaft			Housing			Cage		G <sub>1</sub>	G <sub>2</sub>	C <sub>g</sub>	
			Max Shaft Fillet Radius R <sup>(5)</sup>	Backing Shoulder Dia. d <sub>a</sub> d <sub>b</sub>		Max Housing Fillet Radius r <sup>(5)</sup>	Backing Shoulder Dia. D <sub>a</sub> D <sub>b</sub>		A <sub>a</sub> <sup>(6)</sup>	A <sub>b</sub> <sup>(7)</sup>				
mm in.	mm in.	mm in.	mm in.	mm in.	mm in.	mm in.	mm in.	mm in.	mm in.	mm in.				kg lbs.
30.162 1.1875	23.812 0.9375	-6.6 -0.26	3.5 0.14	61.0 2.40	68.0 2.68	3.3 0.13	107.0 4.21	101.0 3.98	1.6 0.06	2.7 0.11	84.3	23.7	0.1074	1.50 3.31
30.162 1.1875	23.812 0.9375	-6.6 -0.26	0.8 0.03	61.0 2.40	62.0 2.44	0.8 0.03	107.0 4.21	103.0 4.06	1.6 0.06	2.7 0.11	84.3	23.7	0.1074	1.51 3.35
30.162 1.1875	23.812 0.9375	-6.6 -0.26	0.8 0.03	61.0 2.40	62.0 2.44	3.3 0.13	107.0 4.21	101.0 3.98	1.6 0.06	2.7 0.11	84.3	23.7	0.1074	1.51 3.33
30.162 1.1875	23.812 0.9375	-6.6 -0.26	3.5 0.14	61.0 2.40	68.0 2.68	0.8 0.03	107.0 4.21	103.0 4.06	1.6 0.06	2.7 0.11	84.3	23.7	0.1074	1.50 3.33
44.450 1.7500	34.925 1.3750	-12.4 -0.49	3.5 0.14	60.0 2.36	72.0 2.83	3.3 0.13	107.0 4.21	97.0 3.82	3.6 0.14	1.1 0.05	63.1	13.0	0.1053	2.15 4.73
31.750 1.2500	23.812 0.9375	-0.3 -0.01	3.5 0.14	65.0 2.56	71.0 2.80	3.3 0.13	111.0 4.37	100.0 3.94	5.0 0.19	2.0 0.08	50.2	16.4	0.0751	1.63 3.61
41.275 1.6250	31.750 1.2500	-14.0 -0.55	3.5 0.14	61.0 2.40	67.0 2.64	3.3 0.13	110.0 4.33	105.0 4.13	3.8 0.15	1.9 0.08	75.9	16.2	0.0694	2.27 5.00
43.764 1.7230	36.512 1.4375	-12.2 -0.48	1.3 0.05	65.0 2.56	67.0 2.64	3.3 0.13	116.0 4.57	106.0 4.17	2.5 0.09	1.3 0.05	110.4	24.2	0.0825	2.68 5.92
32.791 1.2910	25.400 1.0000	2.0 0.08	3.5 0.14	67.0 2.64	77.0 3.03	3.3 0.13	116.0 4.57	102.0 4.02	4.7 0.18	4.4 0.18	57.4	15.9	0.0825	2.12 4.68
32.791 1.2910	25.400 1.0000	2.0 0.08	0.8 0.03	67.0 2.64	77.0 3.03	3.3 0.13	116.0 4.57	102.0 4.02	4.7 0.18	4.4 0.18	57.4	15.9	0.0825	2.12 4.68
36.678 1.4440	30.162 1.1875	-9.4 -0.37	2.3 0.09	62.0 2.44	66.0 2.60	3.3 0.13	116.0 4.57	109.0 4.29	2.3 0.09	1.3 0.05	91.0	21.1	0.1108	2.31 5.09
36.678 1.4440	33.338 1.3125	-9.4 -0.37	2.3 0.09	62.0 2.44	66.0 2.60	3.3 0.13	116.0 4.57	109.0 4.29	2.3 0.09	1.3 0.05	91.0	21.1	0.1108	2.36 5.20
36.512 1.4375	26.988 1.0625	-3.8 -0.15	3.5 0.14	69.0 2.72	75.0 2.95	3.3 0.13	121.0 4.76	111.0 4.37	4.0 0.15	1.3 0.06	91.7	22.9	0.1252	2.41 5.33
44.450 1.7500	34.925 1.3750	-9.4 -0.37	3.5 0.14	69.0 2.72	75.0 2.95	3.3 0.13	119.0 4.69	107.0 4.21	4.1 0.16	1.1 0.05	83.2	17.2	0.0827	2.90 6.38
52.388 2.0625	41.275 1.6250	-19.6 -0.77	3.5 0.14	65.0 2.56	71.0 2.80	3.3 0.13	117.0 4.61	108.0 4.25	2.3 0.09	2.6 0.11	103.1	18.7	0.0757	3.37 7.42
22.225 0.8750	16.513 0.6501	-4.3 -0.17	2.0 0.08	56.0 2.20	59.0 2.32	1.3 0.05	84.0 3.31	81.0 3.19	0.4 0.01	1.1 0.04	33.8	14.0	0.0773	0.50 1.10
22.225 0.8750	15.875 0.6250	-4.3 -0.17	2.0 0.08	56.0 2.20	59.0 2.32	2.0 0.08	84.0 3.31	81.0 3.19	0.4 0.01	1.1 0.04	33.8	14.0	0.0773	0.50 1.11

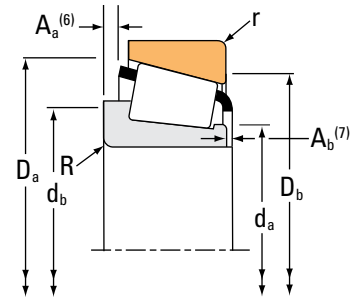
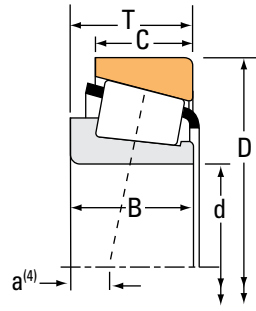
<sup>(4)</sup>Negative value indicates effective center inside cone (inner-ring) backface.  
<sup>(5)</sup>These maximum fillet radii will be cleared by the bearing corners.  
<sup>(6)</sup>Negative value indicates cage extends beyond cone (inner-ring) backface.  
<sup>(7)</sup>Negative value indicates cage that does not extend beyond cone (inner-ring) front face.

Continued on next page.

# TAPERED ROLLER BEARINGS

## SINGLE-ROW • TYPE TS

### TYPE TS



Bearing Dimensions			Load Ratings							Part Number			
Bore d	O.D. D	Width T	Dynamic <sup>(1)</sup>		Factors <sup>(2)</sup>		Dynamic <sup>(3)</sup>		Factors <sup>(2)</sup>		Static C <sub>0</sub>	Inner	Outer
			C <sub>1</sub>	e	Y	C <sub>90</sub>	C <sub>a90</sub>	K	N	N			
mm in.	mm in.	mm in.	N lbf			N lbf	N lbf		N lbf				
52.000 2.0472	85.000 3.3465	19.050 0.7500	51600 11600	0.57	1.06	13400 3010	13000 2920	1.03	63900 14400			18204X	18335X
52.387 2.0625	89.980 3.5425	24.750 0.9744	98900 22200	0.38	1.59	25700 5770	16600 3720	1.55	130000 29200			28584	28520
52.387 2.0625	92.075 3.6250	24.608 0.9688	98900 22200	0.38	1.59	25700 5770	16600 3720	1.55	130000 29200			28584	28521
52.387 2.0625	93.264 3.6718	20.638 0.8125	87900 19800	0.34	1.77	22800 5120	13200 2970	1.73	101000 22700			377A	374
52.387 2.0625	93.264 3.6718	20.638 0.8125	104000 23400	0.34	1.77	27000 6070	15700 3520	1.73	101000 22700			377	374
52.387 2.0625	93.264 3.6718	26.988 1.0625	104000 23400	0.34	1.77	27000 6070	15700 3520	1.73	101000 22700			377	3720
52.387 2.0625	93.264 3.6718	26.988 1.0625	87900 19800	0.34	1.77	22800 5120	13200 2970	1.73	101000 22700			377A	3720
52.387 2.0625	93.264 3.6718	26.988 1.0625	104000 23400	0.34	1.77	27000 6070	15700 3520	1.73	101000 22700			377	3730
52.387 2.0625	93.264 3.6718	30.162 1.1875	122000 27500	0.34	1.77	31700 7120	18300 4120	1.73	153000 34300			3767	3720
52.387 2.0625	93.264 3.6718	30.162 1.1875	122000 27500	0.34	1.77	31700 7120	18300 4120	1.73	153000 34300			3767	3730
52.387 2.0625	95.250 3.7500	27.783 1.0938	130000 29200	0.33	1.82	33600 7560	19000 4270	1.77	161000 36200			33890	33821
52.387 2.0625	95.250 3.7500	27.783 1.0938	130000 29200	0.33	1.82	33600 7560	19000 4270	1.77	161000 36200			33891	33821
52.387 2.0625	96.838 3.8125	22.225 0.8750	104000 23400	0.34	1.77	27000 6070	15700 3520	1.73	101000 22700			377	372A
52.387 2.0625	98.425 3.8750	30.162 1.1875	122000 27500	0.34	1.77	31700 7120	18300 4120	1.73	153000 34300			3767	3732
52.387 2.0625	100.000 3.9370	24.999 0.9842	104000 23400	0.34	1.77	27000 6070	15700 3520	1.73	101000 22700			377	372
52.387 2.0625	104.775 4.1250	30.162 1.1875	161000 36100	0.34	1.79	41700 9370	23900 5380	1.74	166000 37200			468	453X
52.387 2.0625	107.950 4.2500	27.783 1.0938	161000 36100	0.34	1.79	41700 9370	23900 5380	1.74	166000 37200			468	453A

<sup>(1)</sup>Based on 1 x 10<sup>6</sup> revolutions L<sub>10</sub> life, for the ISO life-calculation method.

<sup>(2)</sup>Consult your Timken engineer for instructions on use or review the Timken Engineering Manual on timken.com/catalogs.

<sup>(3)</sup>Based on 90 x 10<sup>6</sup> revolutions L<sub>10</sub> life, for The Timken Company life-calculation method. C<sub>90</sub> and C<sub>a90</sub> are radial and thrust values.



Bearing Dimensions											Geometry Factors			Bearing Weight
Width B	Width C	Eff. Ctr. a <sup>(4)</sup>	Shaft			Housing			Cage		G <sub>1</sub>	G <sub>2</sub>	C <sub>g</sub>	
			Max Shaft Fillet Radius R <sup>(5)</sup>	Backing Shoulder Dia. d <sub>a</sub>	Backing Shoulder Dia. d <sub>b</sub>	Max Housing Fillet Radius r <sup>(5)</sup>	Backing Shoulder Dia. D <sub>a</sub>	Backing Shoulder Dia. D <sub>b</sub>	A <sub>a</sub> <sup>(6)</sup>	A <sub>b</sub> <sup>(7)</sup>				
mm in.	mm in.	mm in.	mm in.	mm in.	mm in.	mm in.	mm in.	mm in.	mm in.	mm in.				kg lbs.
18.263 0.7190	12.500 0.4921	2.0 0.08	2.0 0.08	57.0 2.24	60.0 2.36	1.5 0.06	81.0 3.19	76.0 2.99	2.5 0.10	1.7 0.07	26.1	22.1	0.0852	0.36 0.81
25.400 1.0000	19.987 0.7869	-4.8 -0.19	3.5 0.14	58.0 2.28	65.0 2.56	2.3 0.09	86.0 3.39	81.0 3.19	1.4 0.05	1.1 0.05	46.4	18.9	0.0912	0.62 1.36
25.400 1.0000	19.845 0.7813	-4.8 -0.19	3.5 0.14	58.0 2.28	65.0 2.56	0.8 0.03	87.0 3.43	83.0 3.27	1.4 0.05	1.1 0.05	46.4	18.9	0.0912	0.66 1.47
22.225 0.8750	15.083 0.5938	-3.8 -0.15	4.8 0.19	58.0 2.28	67.0 2.64	1.3 0.05	88.0 3.46	85.0 3.35	0.8 0.03	1.5 0.06	37.6	15.4	0.0816	0.56 1.23
22.225 0.8750	15.083 0.5938	-3.8 -0.15	2.3 0.09	58.0 2.28	62.0 2.44	1.3 0.05	88.0 3.46	85.0 3.35	0.8 0.03	1.5 0.06	37.6	15.4	0.0816	0.57 1.26
22.225 0.8750	23.812 0.9375	-3.8 -0.15	2.3 0.09	58.0 2.28	62.0 2.44	3.3 0.13	87.9 3.46	82.0 3.23	0.8 0.03	1.5 0.06	37.6	15.4	0.0816	0.69 1.52
22.225 0.8750	23.812 0.9375	-3.8 -0.15	4.8 0.19	58.0 2.28	67.0 2.64	3.3 0.13	87.9 3.46	82.0 3.23	0.8 0.03	1.5 0.06	37.6	15.4	0.0816	0.68 1.49
22.225 0.8750	23.812 0.9375	-3.8 -0.15	2.3 0.09	58.0 2.28	62.0 2.44	0.8 0.03	88.0 3.46	84.0 3.31	0.8 0.03	1.5 0.06	37.6	15.4	0.0816	0.70 1.53
30.302 1.1930	23.812 0.9375	-8.1 -0.32	2.3 0.09	59.0 2.32	63.0 2.48	3.3 0.13	87.9 3.46	82.0 3.23	1.8 0.07	1.0 0.04	49.9	14.5	0.0903	0.83 1.81
30.302 1.1930	23.812 0.9375	-8.1 -0.32	2.3 0.09	59.0 2.32	63.0 2.48	0.8 0.03	88.0 3.46	84.0 3.31	1.8 0.07	1.0 0.04	49.9	14.5	0.0903	0.84 1.83
28.575 1.1250	22.225 0.8750	-7.6 -0.30	1.5 0.06	59.0 2.32	61.0 2.40	2.3 0.09	90.0 3.54	85.0 3.35	1.3 0.05	2.2 0.09	52.5	18.5	0.0910	0.83 1.82
28.575 1.1250	22.225 0.8750	-7.6 -0.30	3.5 0.14	59.0 2.32	66.0 2.60	2.3 0.09	90.0 3.54	85.0 3.35	1.3 0.05	2.2 0.09	52.5	18.5	0.0910	0.82 1.80
22.225 0.8750	19.050 0.7500	-3.8 -0.15	2.3 0.09	58.0 2.28	62.0 2.44	1.5 0.06	90.0 3.54	86.0 3.39	0.8 0.03	1.5 0.06	37.6	15.4	0.0816	0.69 1.52
30.302 1.1930	23.812 0.9375	-8.1 -0.32	2.3 0.09	59.0 2.32	63.0 2.48	3.3 0.13	89.9 3.54	84.1 3.31	1.8 0.07	1.0 0.04	49.9	14.5	0.0903	0.97 2.12
22.225 0.8750	21.824 0.8592	-3.8 -0.15	2.3 0.09	58.0 2.28	62.0 2.44	2.0 0.08	90.0 3.54	86.0 3.39	0.8 0.03	1.5 0.06	37.6	15.4	0.0816	0.83 1.83
29.317 1.1542	24.605 0.9687	-7.1 -0.28	1.5 0.06	60.0 2.36	62.0 2.44	3.3 0.13	98.0 3.86	92.0 3.62	2.1 0.08	1.4 0.06	58.6	17.1	0.0946	1.13 2.48
29.317 1.1542	22.225 0.8750	-7.1 -0.28	1.5 0.06	60.0 2.36	62.0 2.44	0.8 0.03	100.0 3.94	97.0 3.82	2.1 0.08	1.4 0.06	58.6	17.1	0.0946	1.18 2.60

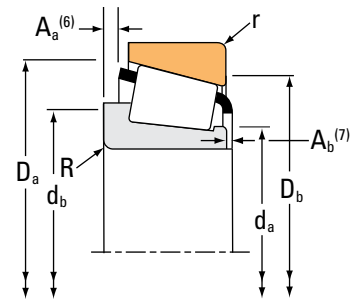
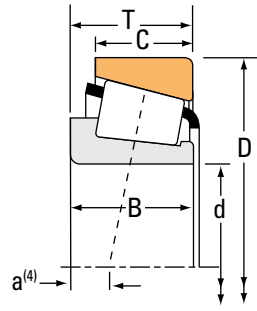
<sup>(4)</sup>Negative value indicates effective center inside cone (inner-ring) backface.  
<sup>(5)</sup>These maximum fillet radii will be cleared by the bearing corners.  
<sup>(6)</sup>Negative value indicates cage extends beyond cone (inner-ring) backface.  
<sup>(7)</sup>Negative value indicates cage that does not extend beyond cone (inner-ring) front face.

Continued on next page.

# TAPERED ROLLER BEARINGS

## SINGLE-ROW • TYPE TS

### TYPE TS



Bearing Dimensions			Load Ratings							Part Number			
Bore d	O.D. D	Width T	Dynamic <sup>(1)</sup>		Factors <sup>(2)</sup>		Dynamic <sup>(3)</sup>		Factors <sup>(2)</sup>		Static C <sub>0</sub>	Inner	Outer
			C <sub>1</sub>	e	Y	C <sub>90</sub>	C <sub>a90</sub>	K	N	N			
mm in.	mm in.	mm in.	N lbf			N lbf	N lbf		N lbf				
52.387 2.0625	107.950 4.2500	27.783 1.0938	161000 36100	0.34	1.79	41700 9370	23900 5380	1.74	166000 37200		468	453AS	
52.387 2.0625	107.950 4.2500	36.512 1.4375	172000 38700	0.30	2.02	44600 10000	22700 5090	1.97	206000 46200		540	532X	
52.387 2.0625	110.000 4.3307	34.130 1.3437	172000 38700	0.30	2.02	44600 10000	22700 5090	1.97	206000 46200		540	534	
52.387 2.0625	111.125 4.3750	30.162 1.1875	126000 28300	0.88	0.68	32700 7350	49500 11100	0.66	119000 26700		55206	55437	
52.387 2.0625	111.125 4.3750	30.162 1.1875	151000 34000	0.88	0.68	39200 8810	59300 13300	0.66	161000 36200		55206C	55437	
52.387 2.0625	111.125 4.3750	38.100 1.5000	172000 38700	0.30	2.02	44600 10000	22700 5090	1.97	206000 46200		540	532A	
52.387 2.0625	112.712 4.4375	30.162 1.1875	126000 28300	0.88	0.68	32700 7350	49500 11100	0.66	119000 26700		55206	55443	
53.975 2.1250	87.312 3.4375	18.258 0.7188	62700 14100	0.39	1.54	16300 3650	10800 2430	1.50	95600 21500		L507945	L507910	
53.975 2.1250	88.900 3.5000	19.050 0.7500	65500 14700	0.55	1.10	17000 3820	15900 3570	1.07	81800 18400		LM806649	LM806610	
53.975 2.1250	95.250 3.7500	27.783 1.0938	130000 29200	0.33	1.82	33600 7560	19000 4270	1.77	161000 36200		33895	33821	
53.975 2.1250	95.250 3.7500	27.783 1.0938	130000 29200	0.33	1.82	33600 7560	19000 4270	1.77	161000 36200		33895	33822	
53.975 2.1250	96.838 3.8125	21.000 0.8268	108000 24200	0.35	1.69	28000 6280	16900 3810	1.65	107000 24100		389A	382A	
53.975 2.1250	98.425 3.8750	21.000 0.8268	108000 24200	0.35	1.69	28000 6280	16900 3810	1.65	107000 24100		389A	382	
53.975 2.1250	100.000 3.9370	21.000 0.8268	108000 24200	0.35	1.69	28000 6280	16900 3810	1.65	107000 24100		389A	383A	
53.975 2.1250	104.775 4.1250	30.162 1.1875	153000 34500	0.33	1.80	39700 8930	22600 5090	1.76	189000 42600		45287	45221	
53.975 2.1250	104.775 4.1250	30.162 1.1875	161000 36100	0.34	1.79	41700 9370	23900 5380	1.74	166000 37200		456	453X	
53.975 2.1250	104.775 4.1250	30.162 1.1875	153000 34500	0.33	1.80	39700 8930	22600 5090	1.76	189000 42600		45287	45220	

<sup>(1)</sup>Based on  $1 \times 10^6$  revolutions  $L_{10}$  life, for the ISO life-calculation method.

<sup>(2)</sup>Consult your Timken engineer for instructions on use or review the Timken Engineering Manual on [timken.com/catalogs](http://timken.com/catalogs).

<sup>(3)</sup>Based on  $90 \times 10^6$  revolutions  $L_{10}$  life, for The Timken Company life-calculation method.  $C_{90}$  and  $C_{a90}$  are radial and thrust values.

Bearing Dimensions											Geometry Factors			Bearing Weight
Width B	Width C	Eff. Ctr. a <sup>(4)</sup>	Shaft			Housing			Cage		G <sub>1</sub>	G <sub>2</sub>	C <sub>g</sub>	
			Max Shaft Fillet Radius R <sup>(5)</sup>	Backing Shoulder Dia. d <sub>a</sub>	Backing Shoulder Dia. d <sub>b</sub>	Max Housing Fillet Radius r <sup>(5)</sup>	Backing Shoulder Dia. D <sub>a</sub>	Backing Shoulder Dia. D <sub>b</sub>	A <sub>a</sub> <sup>(6)</sup>	A <sub>b</sub> <sup>(7)</sup>				
mm in.	mm in.	mm in.	mm in.	mm in.	mm in.	mm in.	mm in.	mm in.	mm in.	mm in.				kg lbs.
29.317 1.1542	22.225 0.8750	-7.1 -0.28	1.5 0.06	60.0 2.36	62.0 2.44	2.3 0.09	100.0 3.94	95.0 3.74	2.1 0.08	1.4 0.06	58.6	17.1	0.0946	1.18 2.60
36.957 1.4550	28.575 1.1250	-12.2 -0.48	3.5 0.14	60.0 2.36	67.0 2.64	3.3 0.13	100.0 3.94	94.0 3.70	2.7 0.10	1.0 0.04	64.3	16.1	0.0938	1.48 3.27
36.957 1.4550	26.988 1.0625	-12.2 -0.48	3.5 0.14	60.0 2.36	67.0 2.64	3.3 0.13	100.0 3.94	94.0 3.70	2.7 0.10	1.0 0.04	64.3	16.1	0.0938	1.51 3.33
26.909 1.0594	20.638 0.8125	7.1 0.28	3.5 0.14	63.9 2.51	72.0 2.83	3.3 0.13	105.0 4.13	92.0 3.62	4.8 0.18	3.2 0.13	36.8	13.2	0.1085	1.24 2.73
26.909 1.0594	20.638 0.8125	7.6 0.30	3.5 0.14	64.4 2.54	72.0 2.83	3.3 0.13	105.0 4.13	92.0 3.62	5.0 0.19	3.7 0.15	48.7	18.1	0.1198	1.33 2.92
36.957 1.4550	30.162 1.1875	-12.2 -0.48	3.5 0.14	60.0 2.36	67.0 2.64	3.3 0.13	100.0 3.94	95.0 3.74	2.7 0.10	1.0 0.04	64.3	16.1	0.0938	1.66 3.65
26.909 1.0594	20.638 0.8125	7.1 0.28	3.5 0.14	63.9 2.51	72.0 2.83	3.3 0.13	106.0 4.17	92.0 3.62	4.8 0.18	3.2 0.13	36.8	13.2	0.1085	1.27 2.81
18.258 0.7188	14.288 0.5625	-0.8 -0.03	1.5 0.06	60.0 2.36	62.0 2.44	1.5 0.06	83.0 3.27	79.0 3.11	0.3 0.01	2.0 0.08	46.1	38.5	0.0914	0.43 0.93
19.050 0.7500	13.492 0.5312	2.3 0.09	2.3 0.09	61.0 2.40	65.0 2.56	2.0 0.08	85.0 3.35	80.0 3.15	1.5 0.05	1.6 0.07	31.8	22.1	0.0900	0.42 0.94
28.575 1.1250	22.225 0.8750	-7.6 -0.30	1.5 0.06	60.0 2.36	63.0 2.48	2.3 0.09	90.0 3.54	85.0 3.35	1.3 0.05	2.2 0.09	52.5	18.5	0.0910	0.80 1.75
28.575 1.1250	22.225 0.8750	-7.6 -0.30	1.5 0.06	60.0 2.36	63.0 2.48	0.8 0.03	90.0 3.54	86.0 3.39	1.3 0.05	2.2 0.09	52.5	18.5	0.0910	0.81 1.77
21.946 0.8640	15.875 0.6250	-3.0 -0.12	0.8 0.03	60.0 2.36	61.0 2.40	0.8 0.03	92.0 3.62	89.0 3.50	1.1 0.04	2.0 0.08	42.0	15.7	0.0859	0.64 1.41
21.946 0.8640	17.826 0.7018	-3.0 -0.12	0.8 0.03	60.0 2.36	61.0 2.40	0.8 0.03	92.0 3.62	90.0 3.54	1.1 0.04	2.0 0.08	42.0	15.7	0.0859	0.69 1.51
21.946 0.8640	17.826 0.7018	-3.0 -0.12	0.8 0.03	60.0 2.36	61.0 2.40	2.0 0.08	93.0 3.66	89.0 3.50	1.1 0.04	2.0 0.08	42.0	15.7	0.0859	0.72 1.59
30.958 1.2188	23.812 0.9375	-8.1 -0.32	0.8 0.03	62.0 2.44	62.0 2.44	0.8 0.03	99.0 3.90	95.0 3.74	2.1 0.08	1.8 0.07	63.5	16.9	0.0971	1.16 2.54
29.317 1.1542	24.605 0.9687	-7.1 -0.28	3.5 0.14	61.0 2.40	68.0 2.68	3.3 0.13	98.0 3.86	92.0 3.62	2.1 0.08	1.4 0.06	58.6	17.1	0.0946	1.11 2.43
30.958 1.2188	23.812 0.9375	-8.1 -0.32	0.8 0.03	62.0 2.44	62.0 2.44	3.3 0.13	99.0 3.90	93.0 3.66	2.1 0.08	1.8 0.07	63.5	16.9	0.0971	1.16 2.54

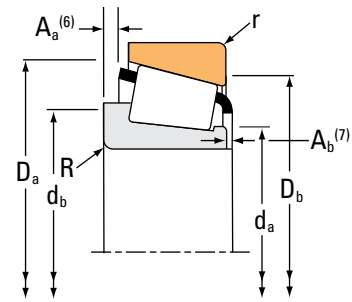
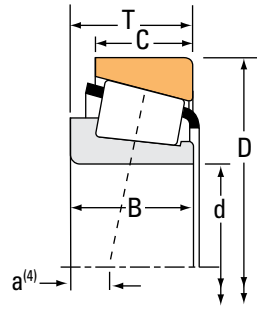
<sup>(4)</sup>Negative value indicates effective center inside cone (inner-ring) backface.  
<sup>(5)</sup>These maximum fillet radii will be cleared by the bearing corners.  
<sup>(6)</sup>Negative value indicates cage extends beyond cone (inner-ring) backface.  
<sup>(7)</sup>Negative value indicates cage that does not extend beyond cone (inner-ring) front face.

Continued on next page.

# TAPERED ROLLER BEARINGS

## SINGLE-ROW • TYPE TS

### TYPE TS



Bearing Dimensions			Load Ratings							Part Number		
Bore d	O.D. D	Width T	Dynamic <sup>(1)</sup>		Factors <sup>(2)</sup>		Dynamic <sup>(3)</sup>		Factors <sup>(2)</sup>	Static	Inner	Outer
			C <sub>1</sub>	e	Y	C <sub>90</sub>	C <sub>a90</sub>	K	C <sub>0</sub>			
mm in.	mm in.	mm in.	N lbf			N lbf	N lbf			N lbf		
53.975 2.1250	104.775 4.1250	36.512 1.4375	203000 45700	0.49	1.23	52700 11900	44000 9890	1.20		223000 50200	HM807049	HM807010
53.975 2.1250	104.775 4.1250	36.512 1.4375	203000 45700	0.49	1.23	52700 11900	44000 9890	1.20		223000 50200	HM807049	HM807011
53.975 2.1250	104.775 4.1250	36.512 1.4375	203000 45700	0.49	1.23	52700 11900	44000 9890	1.20		223000 50200	HM807049A	HM807011
53.975 2.1250	104.775 4.1250	39.688 1.5625	180000 40500	0.34	1.79	46800 10500	26800 6030	1.74		237000 53200	4595	4535
53.975 2.1250	107.950 4.2500	27.783 1.0938	161000 36100	0.34	1.79	41700 9370	23900 5380	1.74		166000 37200	456	453A
53.975 2.1250	107.950 4.2500	27.783 1.0938	161000 36100	0.34	1.79	41700 9370	23900 5380	1.74		166000 37200	456	453AS
53.975 2.1250	107.950 4.2500	27.795 1.0943	161000 36100	0.34	1.79	41700 9370	23900 5380	1.74		166000 37200	456	453
53.975 2.1250	107.950 4.2500	32.558 1.2818	161000 36100	0.34	1.79	41700 9370	23900 5380	1.74		166000 37200	456	452A
53.975 2.1250	107.950 4.2500	36.512 1.4375	204000 45900	0.30	2.02	52900 11900	26800 6040	1.97		206000 46200	539	532X
53.975 2.1250	107.950 4.2500	36.512 1.4375	204000 45900	0.30	2.02	52900 11900	26800 6040	1.97		206000 46200	539A	532X
53.975 2.1250	110.000 4.3307	27.783 1.0938	161000 36100	0.34	1.79	41700 9370	23900 5380	1.74		166000 37200	456	454
53.975 2.1250	110.000 4.3307	34.130 1.3437	204000 45900	0.30	2.02	52900 11900	26800 6040	1.97		206000 46200	539	534
53.975 2.1250	111.125 4.3750	38.100 1.5000	204000 45900	0.30	2.02	52900 11900	26800 6040	1.97		206000 46200	539A	532A
53.975 2.1250	111.125 4.3750	38.895 1.5313	180000 40500	0.34	1.79	46800 10500	26800 6030	1.74		237000 53200	4595	4536
53.975 2.1250	112.712 4.4375	30.162 1.1875	167000 37500	0.34	1.77	43300 9730	25100 5650	1.72		224000 50300	39578	39520
53.975 2.1250	117.475 4.6250	33.338 1.3125	177000 39700	0.63	0.96	45800 10300	49100 11000	0.93		166000 37300	66212	66461
53.975 2.1250	117.475 4.6250	33.338 1.3125	177000 39700	0.63	0.96	45800 10300	49100 11000	0.93		166000 37300	66212	66462

<sup>(1)</sup>Based on 1 x 10<sup>6</sup> revolutions L<sub>10</sub> life, for the ISO life-calculation method.

<sup>(2)</sup>Consult your Timken engineer for instructions on use or review the Timken Engineering Manual on timken.com/catalogs.

<sup>(3)</sup>Based on 90 x 10<sup>6</sup> revolutions L<sub>10</sub> life, for The Timken Company life-calculation method. C<sub>90</sub> and C<sub>a90</sub> are radial and thrust values.

Bearing Dimensions											Geometry Factors			Bearing Weight
Width B	Width C	Eff. Ctr. a <sup>(4)</sup>	Shaft			Housing			Cage		G <sub>1</sub>	G <sub>2</sub>	C <sub>g</sub>	
			Max Shaft Fillet Radius R <sup>(5)</sup>	Backing Shoulder Dia. d <sub>a</sub> d <sub>b</sub>		Max Housing Fillet Radius r <sup>(5)</sup>	Backing Shoulder Dia. D <sub>a</sub> D <sub>b</sub>		A <sub>a</sub> <sup>(6)</sup>	A <sub>b</sub> <sup>(7)</sup>				
mm in.	mm in.	mm in.	mm in.	mm in.	mm in.	mm in.	mm in.	mm in.	mm in.	mm in.				kg lbs.
36.512 1.4375	28.575 1.1250	-7.4 -0.29	3.5 0.14	63.1 2.48	73.0 2.87	3.3 0.13	100.0 3.94	89.0 3.50	3.4 0.13	2.0 0.08	63.9	17.1	0.0760	1.40 3.08
36.512 1.4375	28.575 1.1250	-7.4 -0.29	3.5 0.14	63.1 2.48	73.0 2.87	0.8 0.03	100.0 3.94	91.0 3.58	3.4 0.13	2.0 0.08	63.9	17.1	0.0760	1.40 3.08
36.512 1.4375	28.575 1.1250	-7.4 -0.29	1.5 0.06	63.1 2.48	69.0 2.72	0.8 0.03	100.0 3.94	91.0 3.58	3.4 0.13	2.0 0.08	63.9	17.1	0.0760	1.39 3.07
40.157 1.5810	33.338 1.3125	-12.4 -0.49	3.5 0.14	63.0 2.48	70.0 2.76	3.3 0.13	99.0 3.90	90.0 3.54	1.6 0.06	1.3 0.05	73.6	20.2	0.1027	1.54 3.39
29.317 1.1542	22.225 0.8750	-7.1 -0.28	3.5 0.14	61.0 2.40	68.0 2.68	0.8 0.03	100.0 3.94	97.0 3.82	2.1 0.08	1.4 0.06	58.6	17.1	0.0946	1.16 2.55
29.317 1.1542	22.225 0.8750	-7.1 -0.28	3.5 0.14	61.0 2.40	68.0 2.68	2.3 0.09	100.0 3.94	95.0 3.74	2.1 0.08	1.4 0.06	58.6	17.1	0.0946	1.16 2.55
29.317 1.1542	27.000 1.0630	-7.1 -0.28	3.5 0.14	61.0 2.40	68.0 2.68	0.8 0.03	100.0 3.94	97.0 3.82	2.1 0.08	1.4 0.06	58.6	17.1	0.0946	1.22 2.68
29.317 1.1542	27.000 1.0630	-7.1 -0.28	3.5 0.14	61.0 2.40	68.0 2.68	3.3 0.13	100.0 3.94	93.0 3.66	2.1 0.08	1.4 0.06	58.6	17.1	0.0946	1.27 2.79
36.957 1.4550	28.575 1.1250	-12.2 -0.48	3.5 0.14	61.0 2.40	68.0 2.68	3.3 0.13	100.0 3.94	94.0 3.70	2.7 0.10	1.0 0.04	64.3	16.1	0.0938	1.44 3.19
36.957 1.4550	28.575 1.1250	-12.2 -0.48	5.5 0.22	61.0 2.40	72.0 2.83	3.3 0.13	100.0 3.94	94.0 3.70	2.7 0.10	1.0 0.04	64.3	16.1	0.0938	1.43 3.16
29.317 1.1542	27.000 1.0630	-7.1 -0.28	3.5 0.14	61.0 2.40	68.0 2.68	2.0 0.08	100.0 3.94	96.0 3.78	2.1 0.08	1.4 0.06	58.6	17.1	0.0946	1.29 2.83
36.957 1.4550	26.988 1.0625	-12.2 -0.48	3.5 0.14	61.0 2.40	68.0 2.68	3.3 0.13	100.0 3.94	94.0 3.70	2.7 0.10	1.0 0.04	64.3	16.1	0.0938	1.47 3.24
36.957 1.4550	30.162 1.1875	-12.2 -0.48	5.5 0.22	61.0 2.40	72.0 2.83	3.3 0.13	100.0 3.94	95.0 3.74	2.7 0.10	1.0 0.04	64.3	16.1	0.0938	1.61 3.53
40.157 1.5810	32.545 1.2813	-12.4 -0.49	3.5 0.14	63.0 2.48	70.0 2.76	3.3 0.13	100.0 3.94	93.0 3.66	1.6 0.06	1.3 0.05	73.6	20.2	0.1027	1.80 3.95
30.162 1.1875	23.812 0.9375	-6.6 -0.26	3.5 0.14	64.0 2.52	70.0 2.76	3.3 0.13	107.0 4.21	101.0 3.98	1.6 0.06	2.7 0.11	84.3	23.7	0.1074	1.44 3.18
31.750 1.2500	23.812 0.9375	-0.3 -0.01	3.5 0.14	67.0 2.64	73.0 2.87	0.8 0.03	111.0 4.37	102.0 4.02	5.0 0.19	2.0 0.08	50.2	16.4	0.0751	1.58 3.50
31.750 1.2500	23.812 0.9375	-0.3 -0.01	3.5 0.14	67.0 2.64	73.0 2.87	3.3 0.13	111.0 4.37	100.0 3.94	5.0 0.19	2.0 0.08	50.2	16.4	0.0751	1.57 3.46

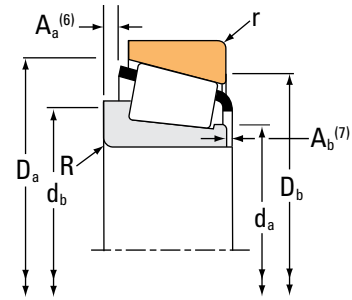
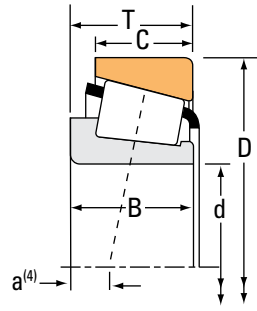
(4) Negative value indicates effective center inside cone (inner-ring) backface.  
 (5) These maximum fillet radii will be cleared by the bearing corners.  
 (6) Negative value indicates cage extends beyond cone (inner-ring) backface.  
 (7) Negative value indicates cage that does not extend beyond cone (inner-ring) front face.

Continued on next page.

# TAPERED ROLLER BEARINGS

## SINGLE-ROW • TYPE TS

### TYPE TS



Bearing Dimensions			Load Ratings							Part Number			
Bore d	O.D. D	Width T	Dynamic <sup>(1)</sup>		Factors <sup>(2)</sup>		Dynamic <sup>(3)</sup>		Factors <sup>(2)</sup>		Static C <sub>0</sub>	Inner	Outer
			C <sub>1</sub>	e	Y	C <sub>90</sub>	C <sub>a90</sub>	K	N	N			
mm in.	mm in.	mm in.	N lbf			N lbf	N lbf		N lbf				
53.975 2.1250	120.650 4.7500	41.275 1.6250	207000 46600	0.31	1.91	53800 12100	28900 6510	1.86	244000 54800			621	612
53.975 2.1250	120.650 4.7500	41.275 1.6250	207000 46600	0.31	1.91	53800 12100	28900 6510	1.86	244000 54800			624	612
53.975 2.1250	120.650 4.7500	41.275 1.6250	207000 46600	0.31	1.91	53800 12100	28900 6510	1.86	244000 54800			621	612-S
53.975 2.1250	122.238 4.8125	33.338 1.3125	183000 41200	0.67	0.90	47500 10700	54100 12200	0.88	178000 39900			66584	66520
53.975 2.1250	122.238 4.8125	43.658 1.7188	237000 53200	0.36	1.67	61300 13800	37600 8460	1.63	327000 73500			5578	5535
53.975 2.1250	122.238 4.8125	43.658 1.7188	237000 53200	0.36	1.67	61300 13800	37600 8460	1.63	327000 73500			5577	5535
53.975 2.1250	123.825 4.8750	36.512 1.4375	214000 48200	0.74	0.81	55500 12500	70100 15800	0.79	208000 46800			72212C	72487
53.975 2.1250	123.825 4.8750	36.512 1.4375	214000 48200	0.74	0.81	55500 12500	70100 15800	0.79	208000 46800			72213C	72487
53.975 2.1250	123.825 4.8750	38.100 1.5000	226000 50800	0.35	1.73	58600 13200	34700 7810	1.69	248000 55700			557-S	552A
53.975 2.1250	127.000 5.0000	36.512 1.4375	214000 48200	0.74	0.81	55500 12500	70100 15800	0.79	208000 46800			72213C	72500
53.975 2.1250	127.000 5.0000	44.450 1.7500	243000 54700	0.49	1.23	63100 14200	52700 11800	1.20	297000 66700			65212	65500
53.975 2.1250	127.000 5.0000	50.800 2.0000	306000 68800	0.30	2.01	79300 17800	40500 9110	1.96	370000 83300			6280	6220
53.975 2.1250	130.175 5.1250	34.100 1.3425	167000 37500	0.82	0.73	43200 9720	60700 13600	0.71	183000 41100			HM911243	HM911210
53.975 2.1250	130.175 5.1250	36.512 1.4375	198000 44400	0.82	0.73	51200 11500	71900 16200	0.71	183000 41100			HM911242	HM911210
53.975 2.1250	134.983 5.3143	33.449 1.3169	167000 37500	0.82	0.73	43200 9720	60700 13600	0.71	183000 41100			HM911243	HM911216
53.975 2.1250	136.525 5.3750	36.512 1.4375	237000 53200	0.87	0.69	61300 13800	90900 20400	0.67	234000 52600			78215C	78537
53.975 2.1250	136.525 5.3750	41.275 1.6250	276000 62100	0.36	1.66	71600 16100	44400 9980	1.61	298000 67000			636	632

<sup>(1)</sup>Based on 1 x 10<sup>6</sup> revolutions L<sub>10</sub> life, for the ISO life-calculation method.

<sup>(2)</sup>Consult your Timken engineer for instructions on use or review the Timken Engineering Manual on timken.com/catalogs.

<sup>(3)</sup>Based on 90 x 10<sup>6</sup> revolutions L<sub>10</sub> life, for The Timken Company life-calculation method. C<sub>90</sub> and C<sub>a90</sub> are radial and thrust values.

Bearing Dimensions											Geometry Factors			Bearing Weight
Width B	Width C	Eff. Ctr. a <sup>(4)</sup>	Shaft			Housing			Cage		G <sub>1</sub>	G <sub>2</sub>	C <sub>g</sub>	
			Max Shaft Fillet Radius R <sup>(5)</sup>	Backing Shoulder Dia. d <sub>a</sub>	Shoulder Dia. d <sub>b</sub>	Max Housing Fillet Radius r <sup>(5)</sup>	Backing Shoulder Dia. D <sub>a</sub>	Shoulder Dia. D <sub>b</sub>	A <sub>a</sub> <sup>(6)</sup>	A <sub>b</sub> <sup>(7)</sup>				
mm in.	mm in.	mm in.	mm in.	mm in.	mm in.	mm in.	mm in.	mm in.	mm in.	mm in.				kg lbs.
41.275 1.6250	31.750 1.2500	-14.0 -0.55	3.5 0.14	63.0 2.48	70.0 2.76	3.3 0.13	110.0 4.33	105.0 4.13	3.8 0.15	1.9 0.08	75.9	16.2	0.0694	2.18 4.82
41.275 1.6250	31.750 1.2500	-14.0 -0.55	0.8 0.03	63.0 2.48	64.0 2.52	3.3 0.13	110.0 4.33	105.0 4.13	3.8 0.15	1.9 0.08	75.9	16.2	0.0694	2.19 4.84
41.275 1.6250	31.750 1.2500	-14.0 -0.55	3.5 0.14	63.0 2.48	70.0 2.76	0.8 0.03	110.0 4.33	107.0 4.21	3.8 0.15	1.9 0.08	75.9	16.2	0.0694	2.19 4.85
31.750 1.2500	23.812 0.9375	2.0 0.08	3.5 0.14	68.0 2.68	75.0 2.95	3.3 0.13	116.0 4.57	105.0 4.13	5.2 0.20	2.0 0.08	57.0	18.3	0.0797	1.76 3.89
43.764 1.7230	36.512 1.4375	-12.2 -0.48	3.5 0.14	67.0 2.64	73.0 2.87	3.3 0.13	116.0 4.57	106.0 4.17	2.5 0.09	1.3 0.05	110.4	24.2	0.0825	2.58 5.71
43.764 1.7230	36.512 1.4375	-12.2 -0.48	1.3 0.05	67.0 2.64	69.0 2.72	3.3 0.13	116.0 4.57	106.0 4.17	2.5 0.09	1.3 0.05	110.4	24.2	0.0825	2.59 5.72
32.791 1.2910	25.400 1.0000	2.0 0.08	3.5 0.14	67.0 2.64	79.0 3.11	3.3 0.13	116.0 4.57	102.0 4.02	4.7 0.18	4.4 0.18	57.4	15.9	0.0825	2.03 4.48
32.791 1.2910	25.400 1.0000	2.0 0.08	3.5 0.14	67.0 2.64	79.0 3.11	3.3 0.13	116.0 4.57	102.0 4.02	4.7 0.18	4.4 0.18	57.4	15.9	0.0825	2.05 4.53
36.678 1.4440	30.162 1.1875	-9.4 -0.37	3.5 0.14	67.0 2.64	73.0 2.87	3.3 0.13	116.0 4.57	109.0 4.29	2.3 0.09	1.3 0.05	91.0	21.1	0.1108	2.24 4.93
32.791 1.2910	25.400 1.0000	2.0 0.08	3.5 0.14	67.0 2.64	79.0 3.11	3.3 0.13	116.0 4.57	103.0 4.06	4.7 0.18	4.4 0.18	57.4	15.9	0.0825	2.16 4.78
44.450 1.7500	34.925 1.3750	-9.4 -0.37	3.5 0.14	71.0 2.80	77.0 3.03	3.3 0.13	119.0 4.69	107.0 4.21	4.1 0.16	1.1 0.05	83.2	17.2	0.0827	2.81 6.18
52.388 2.0625	41.275 1.6250	-19.6 -0.77	3.5 0.14	67.0 2.64	74.0 2.91	3.3 0.13	117.0 4.61	108.0 4.25	2.3 0.09	2.6 0.11	103.1	18.7	0.0757	3.26 7.19
30.924 1.2175	23.812 0.9375	7.9 0.31	3.5 0.14	74.0 2.91	79.0 3.11	3.3 0.13	123.6 4.87	109.0 4.29	4.9 0.19	4.3 0.17	56.4	16.5	0.0842	2.12 4.69
33.338 1.3125	23.812 0.9375	5.3 0.21	3.5 0.14	74.0 2.91	79.0 3.11	3.3 0.13	123.6 4.87	109.0 4.29	7.3 0.29	4.3 0.17	56.4	16.5	0.0842	2.22 4.90
30.924 1.2175	21.948 0.8641	7.9 0.31	3.5 0.14	74.0 2.91	79.0 3.11	3.5 0.14	123.0 4.84	112.0 4.41	4.9 0.19	4.3 0.17	56.4	16.5	0.0842	2.25 4.96
33.236 1.3085	23.520 0.9260	8.4 0.33	3.5 0.14	77.5 3.05	84.0 3.31	3.3 0.13	130.0 5.12	115.0 4.53	6.3 0.25	4.9 0.20	71.3	17.6	0.0926	2.60 5.72
41.275 1.6250	31.750 1.2500	-11.2 -0.44	3.5 0.14	67.0 2.64	73.0 2.87	3.3 0.13	125.0 4.92	118.0 4.65	4.1 0.16	2.0 0.08	106.4	21.0	0.0814	3.11 6.86

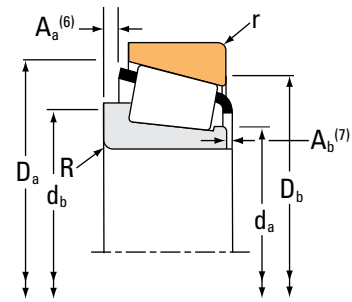
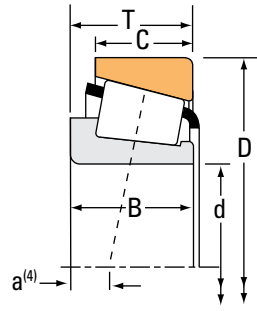
(4) Negative value indicates effective center inside cone (inner-ring) backface.  
 (5) These maximum fillet radii will be cleared by the bearing corners.  
 (6) Negative value indicates cage extends beyond cone (inner-ring) backface.  
 (7) Negative value indicates cage that does not extend beyond cone (inner-ring) front face.

Continued on next page.

# TAPERED ROLLER BEARINGS

## SINGLE-ROW • TYPE TS

### TYPE TS



Bearing Dimensions			Load Ratings							Part Number		
Bore d	O.D. D	Width T	Dynamic <sup>(1)</sup>		Factors <sup>(2)</sup>		Dynamic <sup>(3)</sup>		Factors <sup>(2)</sup>	Static	Inner	Outer
			C <sub>1</sub>	e	Y	C <sub>90</sub>	C <sub>a90</sub>	K	C <sub>0</sub>			
mm in.	mm in.	mm in.	N lbf			N lbf	N lbf			N lbf		
53.975 2.1250	140.030 5.5130	36.512 1.4375	237000 53200	0.87	0.69	61300 13800	90900 20400	0.67		234000 52600	78215C	78551
53.975 2.1250	140.030 5.5130	36.512 1.4375	237000 53200	0.87	0.69	61300 13800	90900 20400	0.67		234000 52600	78214C	78551
54.487 2.1452	104.775 4.1250	36.512 1.4375	203000 45700	0.49	1.23	52700 11900	44000 9890	1.20		223000 50200	HM807048	HM807010
54.987 2.1649	103.188 4.0625	38.100 1.5000	172000 38700	0.30	2.02	44600 10000	22700 5090	1.97		206000 46200	538	533A
54.987 2.1649	110.000 4.3307	38.100 1.5000	172000 38700	0.30	2.02	44600 10000	22700 5090	1.97		206000 46200	538	533X
54.987 2.1649	135.755 5.3447	53.975 2.1250	321000 72300	0.32	1.85	83300 18700	46300 10400	1.80		404000 90900	6381	6320
55.000 2.1654	90.000 3.5433	23.000 0.9055	109000 24500	0.40	1.49	28200 6340	19400 4370	1.45		123000 27600	JLM506849A	JLM506810
55.000 2.1654	90.000 3.5433	23.000 0.9055	91800 20600	0.40	1.49	23800 5350	16400 3680	1.45		123000 27600	JLM506849	JLM506810
55.000 2.1654	90.000 3.5433	25.000 0.9843	109000 24500	0.40	1.49	28200 6340	19400 4370	1.45		123000 27600	JLM506849A	JLM506811
55.000 2.1654	95.000 3.7402	29.000 1.1417	131000 29300	0.33	1.79	33800 7610	19400 4360	1.74		168000 37700	JM207049	JM207010
55.000 2.1654	95.000 3.7402	29.000 1.1417	131000 29300	0.33	1.79	33800 7610	19400 4360	1.74		168000 37700	JM207049A	JM207010
55.000 2.1654	95.000 3.7402	30.000 1.1811	131000 29300	0.33	1.79	33800 7610	19400 4360	1.74		168000 37700	JM207049	JM207010A
55.000 2.1654	96.838 3.8125	21.000 0.8268	108000 24200	0.35	1.69	28000 6280	16900 3810	1.65		107000 24100	385	382A
55.000 2.1654	96.838 3.8125	21.000 0.8268	108000 24200	0.35	1.69	28000 6280	16900 3810	1.65		107000 24100	385X	382A
55.000 2.1654	98.425 3.8750	21.000 0.8268	108000 24200	0.35	1.69	28000 6280	16900 3810	1.65		107000 24100	385	382
55.000 2.1654	100.000 3.9370	21.000 0.8268	108000 24200	0.35	1.69	28000 6280	16900 3810	1.65		107000 24100	385	383A
55.000 2.1654	110.000 4.3307	39.000 1.5354	210000 47200	0.35	1.73	54400 12200	32300 7260	1.69		251000 56500	JH307749	JH307710

<sup>(1)</sup>Based on 1 x 10<sup>6</sup> revolutions L<sub>10</sub> life, for the ISO life-calculation method.

<sup>(2)</sup>Consult your Timken engineer for instructions on use or review the Timken Engineering Manual on timken.com/catalogs.

<sup>(3)</sup>Based on 90 x 10<sup>6</sup> revolutions L<sub>10</sub> life, for The Timken Company life-calculation method. C<sub>90</sub> and C<sub>a90</sub> are radial and thrust values.



Bearing Dimensions											Geometry Factors			Bearing Weight
Width B	Width C	Eff. Ctr. a <sup>(4)</sup>	Shaft			Housing			Cage		G <sub>1</sub>	G <sub>2</sub>	C <sub>g</sub>	
			Max Shaft Fillet Radius R <sup>(5)</sup>	Backing Shoulder Dia. d <sub>a</sub>	Shoulder Dia. d <sub>b</sub>	Max Housing Fillet Radius r <sup>(5)</sup>	Backing Shoulder Dia. D <sub>a</sub>	Shoulder Dia. D <sub>b</sub>	A <sub>a</sub> <sup>(6)</sup>	A <sub>b</sub> <sup>(7)</sup>				
mm in.	mm in.	mm in.	mm in.	mm in.	mm in.	mm in.	mm in.	mm in.	mm in.	mm in.				kg lbs.
33.236 1.3085	23.520 0.9260	8.4 0.33	3.5 0.14	77.5 3.05	84.0 3.31	2.3 0.09	132.0 5.20	117.0 4.61	6.3 0.25	4.9 0.20	71.3	17.6	0.0926	2.74 6.04
33.236 1.3085	23.520 0.9260	8.4 0.33	0.8 0.03	0.0 3.05	0.0 3.11	2.3 0.09	132.0 5.20	117.0 4.61	6.3 0.25	4.9 0.20	71.3	17.6	0.0926	2.74 6.06
36.512 1.4375	28.575 1.1250	-7.4 -0.29	3.5 0.14	63.0 2.48	73.0 2.87	3.3 0.13	100.0 3.94	89.0 3.50	3.4 0.13	2.0 0.08	63.9	17.1	0.0760	1.37 3.02
36.957 1.4550	30.162 1.1875	-12.2 -0.48	0.8 0.03	62.0 2.44	63.0 2.48	1.5 0.06	98.0 3.86	93.0 3.66	2.7 0.10	1.0 0.04	64.3	16.1	0.0938	1.29 2.86
36.957 1.4550	30.162 1.1875	-12.2 -0.48	0.8 0.03	62.0 2.44	63.0 2.48	3.3 0.13	100.0 3.94	95.0 3.74	2.7 0.10	1.0 0.04	64.3	16.1	0.0938	1.55 3.43
56.007 2.2050	44.450 1.7500	-19.3 -0.76	3.5 0.14	70.0 2.76	76.0 2.99	3.3 0.13	126.0 4.96	117.0 4.61	4.0 0.15	0.5 0.02	123.5	22.4	0.0827	4.05 8.93
23.000 0.9055	18.500 0.7283	-2.8 -0.11	3.5 0.14	60.0 2.36	67.0 2.64	0.5 0.02	86.0 3.39	82.0 3.23	1.0 0.04	1.6 0.06	45.6	20.4	0.0925	0.54 1.20
23.000 0.9055	18.500 0.7283	-2.8 -0.11	1.5 0.06	61.0 2.40	63.0 2.48	0.5 0.02	86.0 3.39	82.0 3.23	1.0 0.04	1.6 0.06	45.6	20.4	0.0925	0.54 1.21
23.000 0.9055	20.500 0.8071	-2.8 -0.11	3.5 0.14	60.0 2.36	67.0 2.64	0.5 0.02	86.0 3.39	82.0 3.23	1.0 0.04	1.6 0.06	45.6	20.4	0.0925	0.58 1.27
29.000 1.1417	23.500 0.9252	-7.6 -0.30	1.5 0.06	62.0 2.44	64.0 2.52	2.5 0.10	91.0 3.58	85.0 3.35	1.3 0.05	2.4 0.10	56.4	19.9	0.0937	0.83 1.84
29.000 1.1417	23.500 0.9252	-7.6 -0.30	6.0 0.24	62.0 2.44	73.0 2.87	2.5 0.10	91.0 3.58	85.0 3.35	1.3 0.05	2.4 0.10	56.4	19.9	0.0937	0.80 1.79
29.000 1.1417	24.500 0.9646	-7.6 -0.30	1.5 0.06	62.0 2.44	64.0 2.52	2.0 0.08	91.0 3.58	87.0 3.43	1.3 0.05	2.4 0.10	56.4	19.9	0.0937	0.86 1.90
21.946 0.8640	15.875 0.6250	-3.0 -0.12	2.3 0.09	61.0 2.40	65.0 2.56	0.8 0.03	92.0 3.62	89.0 3.50	1.1 0.04	2.0 0.08	42.0	15.7	0.0859	0.62 1.38
21.946 0.8640	15.875 0.6250	-3.0 -0.12	3.5 0.14	61.0 2.40	67.0 2.64	0.8 0.03	92.0 3.62	89.0 3.50	1.1 0.04	2.0 0.08	42.0	15.7	0.0859	0.62 1.37
21.946 0.8640	17.826 0.7018	-3.0 -0.12	2.3 0.09	61.0 2.40	65.0 2.56	0.8 0.03	92.0 3.62	90.0 3.54	1.1 0.04	2.0 0.08	42.0	15.7	0.0859	0.67 1.48
21.946 0.8640	17.826 0.7018	-3.0 -0.12	2.3 0.09	61.0 2.40	65.0 2.56	2.0 0.08	93.0 3.66	89.0 3.50	1.1 0.04	2.0 0.08	42.0	15.7	0.0859	0.70 1.55
39.000 1.5354	32.000 1.2598	-11.7 -0.46	3.0 0.12	64.0 2.52	71.0 2.80	2.5 0.10	104.0 4.09	97.0 3.82	0.8 0.03	3.1 0.13	72.0	16.9	0.0706	1.69 3.71

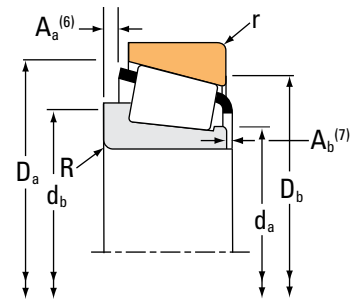
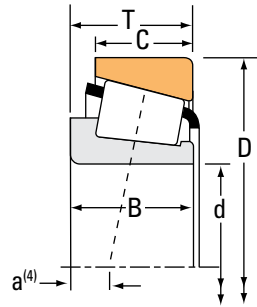
<sup>(4)</sup>Negative value indicates effective center inside cone (inner-ring) backface.  
<sup>(5)</sup>These maximum fillet radii will be cleared by the bearing corners.  
<sup>(6)</sup>Negative value indicates cage extends beyond cone (inner-ring) backface.  
<sup>(7)</sup>Negative value indicates cage that does not extend beyond cone (inner-ring) front face.

Continued on next page.

# TAPERED ROLLER BEARINGS

## SINGLE-ROW • TYPE TS

### TYPE TS



Bearing Dimensions			Load Ratings							Part Number		
Bore d	O.D. D	Width T	Dynamic <sup>(1)</sup>		Factors <sup>(2)</sup>		Dynamic <sup>(3)</sup>		Factors <sup>(2)</sup>	Static	Inner	Outer
			C <sub>1</sub>	e	Y	C <sub>90</sub>	C <sub>a90</sub>	K	C <sub>0</sub>			
mm in.	mm in.	mm in.	N lbf			N lbf	N lbf			N lbf		
55.000 2.1654	115.000 4.5276	34.000 1.3386	14500 32700	0.87	0.69	37700 8470	55800 12600	0.67		175000 39200	JW5549	JW5510
55.000 2.1654	115.000 4.5276	41.021 1.6150	207000 46600	0.31	1.91	53800 12100	28900 6510	1.86		244000 54800	622X	614X
55.000 2.1654	120.000 4.7244	29.002 1.1418	143000 32200	0.38	1.56	37200 8360	24500 5500	1.52		186000 41900	475	472A
55.000 2.1654	120.000 4.7244	29.794 1.1730	143000 32200	0.38	1.56	37200 8360	24500 5500	1.52		186000 41900	475	472
55.000 2.1654	120.000 4.7244	29.794 1.1730	143000 32200	0.38	1.56	37200 8360	24500 5500	1.52		186000 41900	475	473
55.000 2.1654	123.825 4.8750	38.100 1.5000	191000 42900	0.35	1.73	49400 11100	29300 6590	1.69		248000 55700	557	552A
55.006 2.1656	120.040 4.7260	41.275 1.6250	207000 46600	0.31	1.91	53800 12100	28900 6510	1.86		244000 54800	622A	612A
55.562 2.1875	97.630 3.8437	24.608 0.9688	123000 27700	0.40	1.49	32000 7180	22000 4950	1.45		142000 32000	28680	28622
55.562 2.1875	107.950 4.2500	27.783 1.0938	161000 36100	0.34	1.79	41700 9370	23900 5380	1.74		166000 37200	466-S	453A
55.562 2.1875	107.950 4.2500	27.783 1.0938	161000 36100	0.34	1.79	41700 9370	23900 5380	1.74		166000 37200	466-S	453AS
55.562 2.1875	122.238 4.8125	43.658 1.7188	237000 53200	0.36	1.67	61300 13800	37600 8460	1.63		327000 73500	5566	5535
55.562 2.1875	123.825 4.8750	36.512 1.4375	214000 48200	0.74	0.81	55500 12500	70100 15800	0.79		208000 46800	72218C	72487
55.562 2.1875	123.825 4.8750	36.512 1.4375	214000 48200	0.74	0.81	55500 12500	70100 15800	0.79		208000 46800	72219C	72487
55.562 2.1875	127.000 5.0000	36.512 1.4375	229000 51500	0.50	1.20	59400 13400	51100 11500	1.16		256000 57600	HM813840	HM813811
55.562 2.1875	127.000 5.0000	36.512 1.4375	229000 51500	0.50	1.20	59400 13400	51100 11500	1.16		256000 57600	HM813840	HM813810
55.575 2.1880	96.838 3.8125	21.000 0.8268	108000 24200	0.35	1.69	28000 6280	16900 3810	1.65		107000 24100	389	382A
55.575 2.1880	100.000 3.9370	20.980 0.8268	108000 24200	0.35	1.69	28000 6280	16900 3810	1.65		107000 24100	389	383A

<sup>(1)</sup>Based on  $1 \times 10^6$  revolutions  $L_{10}$  life, for the ISO life-calculation method.

<sup>(2)</sup>Consult your Timken engineer for instructions on use or review the Timken Engineering Manual on [timken.com/catalogs](http://timken.com/catalogs).

<sup>(3)</sup>Based on  $90 \times 10^6$  revolutions  $L_{10}$  life, for The Timken Company life-calculation method.  $C_{90}$  and  $C_{a90}$  are radial and thrust values.

Bearing Dimensions											Geometry Factors			Bearing Weight
Width B	Width C	Eff. Ctr. a <sup>(4)</sup>	Shaft			Housing			Cage		G <sub>1</sub>	G <sub>2</sub>	C <sub>g</sub>	
			Max Shaft Fillet Radius R <sup>(5)</sup>	Backing Shoulder Dia. d <sub>a</sub>	Backing Shoulder Dia. d <sub>b</sub>	Max Housing Fillet Radius r <sup>(5)</sup>	Backing Shoulder Dia. D <sub>a</sub>	Backing Shoulder Dia. D <sub>b</sub>	A <sub>a</sub> <sup>(6)</sup>	A <sub>b</sub> <sup>(7)</sup>				
mm in.	mm in.	mm in.	mm in.	mm in.	mm in.	mm in.	mm in.	mm in.	mm in.	mm in.				kg lbs.
31.000 1.2205	23.500 0.9252	5.8 0.23	3.0 0.12	66.0 2.59	78.0 3.07	3.0 0.12	109.0 4.29	95.0 3.74	5.2 0.20	3.8 0.15	51.1	15.8	0.0831	1.57 3.46
41.275 1.6250	31.496 1.2400	-14.0 -0.55	3.0 0.12	64.0 2.52	70.0 2.76	3.0 0.12	108.0 4.25	101.0 3.98	3.8 0.15	1.9 0.08	75.9	16.2	0.0694	1.90 4.18
29.007 1.1420	23.444 0.9230	-4.1 -0.16	0.8 0.03	66.0 2.60	67.0 2.64	3.3 0.13	114.0 4.49	106.0 4.17	1.5 0.05	2.2 0.09	77.2	23.0	0.1083	1.62 3.57
29.007 1.1420	24.237 0.9542	-4.1 -0.16	0.8 0.03	66.0 2.60	67.0 2.64	2.0 0.08	114.0 4.49	107.0 4.21	1.5 0.05	2.2 0.09	77.2	23.0	0.1083	1.65 3.64
29.007 1.1420	29.000 1.1417	-4.1 -0.16	0.8 0.03	66.0 2.60	67.0 2.64	2.0 0.08	114.0 4.49	107.0 4.21	1.5 0.05	2.2 0.09	77.2	23.0	0.1083	1.70 3.75
36.678 1.4440	30.162 1.1875	-9.4 -0.37	3.5 0.14	66.0 2.60	72.0 2.83	3.3 0.13	116.0 4.57	109.0 4.29	2.3 0.09	1.3 0.05	91.0	21.1	0.1108	2.21 4.86
41.275 1.6250	31.750 1.2500	-14.0 -0.55	0.8 0.03	64.0 2.52	65.0 2.56	3.3 0.13	110.0 4.33	103.0 4.06	3.8 0.15	1.9 0.08	75.9	16.2	0.0694	2.13 4.72
24.608 0.9688	19.446 0.7656	-3.3 -0.13	3.5 0.14	62.0 2.44	68.0 2.68	0.8 0.03	92.0 3.62	88.0 3.46	1.5 0.06	1.8 0.08	54.0	22.6	0.0979	0.75 1.67
29.317 1.1542	22.225 0.8750	-7.1 -0.28	2.3 0.09	62.0 2.44	66.0 2.60	0.8 0.03	100.0 3.94	97.0 3.82	2.1 0.08	1.4 0.06	58.6	17.1	0.0946	1.13 2.50
29.317 1.1542	22.225 0.8750	-7.1 -0.28	2.3 0.09	62.0 2.44	66.0 2.60	2.3 0.09	100.0 3.94	95.0 3.74	2.1 0.08	1.4 0.06	58.6	17.1	0.0946	1.13 2.49
43.764 1.7230	36.512 1.4375	-12.2 -0.48	1.3 0.05	68.0 2.68	70.0 2.76	3.3 0.13	116.0 4.57	106.0 4.17	2.5 0.09	1.3 0.05	110.4	24.2	0.0825	2.54 5.62
32.791 1.2910	25.400 1.0000	2.0 0.08	3.5 0.14	67.0 2.64	80.0 3.15	3.3 0.13	116.0 4.57	102.0 4.02	4.7 0.18	4.4 0.18	57.4	15.9	0.0825	2.01 4.45
32.791 1.2910	25.400 1.0000	2.0 0.08	3.5 0.14	67.0 2.64	80.0 3.15	3.3 0.13	116.0 4.57	102.0 4.02	4.7 0.18	4.4 0.18	57.4	15.9	0.0825	2.01 4.45
36.512 1.4375	26.988 1.0625	-3.8 -0.15	3.5 0.14	72.0 2.83	78.0 3.07	1.5 0.06	121.0 4.76	113.0 4.45	4.0 0.15	1.3 0.06	91.7	22.9	0.1252	2.30 5.08
36.512 1.4375	26.988 1.0625	-3.8 -0.15	3.5 0.14	72.0 2.83	78.0 3.07	3.3 0.13	121.0 4.76	111.0 4.37	4.0 0.15	1.3 0.06	91.7	22.9	0.1252	2.30 5.08
21.946 0.8640	15.875 0.6250	-3.0 -0.12	2.3 0.09	61.0 2.40	65.0 2.56	0.8 0.03	92.0 3.62	89.0 3.50	1.1 0.04	2.0 0.08	42.0	15.7	0.0859	0.61 1.35
21.946 0.8640	17.826 0.7018	-3.0 -0.12	2.3 0.09	61.0 2.40	65.0 2.56	2.0 0.08	93.0 3.66	89.0 3.50	1.1 0.04	2.0 0.08	42.0	15.7	0.0859	0.69 1.53

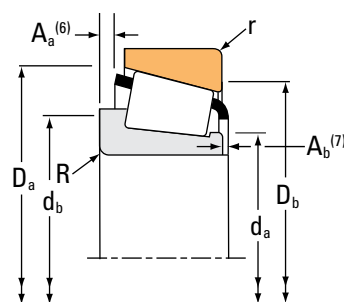
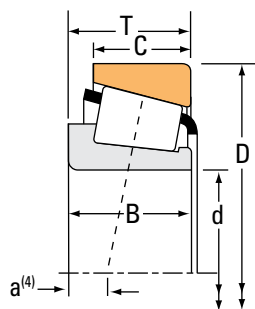
<sup>(4)</sup>Negative value indicates effective center inside cone (inner-ring) backface.  
<sup>(5)</sup>These maximum fillet radii will be cleared by the bearing corners.  
<sup>(6)</sup>Negative value indicates cage extends beyond cone (inner-ring) backface.  
<sup>(7)</sup>Negative value indicates cage that does not extend beyond cone (inner-ring) front face.

Continued on next page.

# TAPERED ROLLER BEARINGS

## SINGLE-ROW • TYPE TS

### TYPE TS



Bearing Dimensions			Load Ratings							Part Number			
Bore d	O.D. D	Width T	Dynamic <sup>(1)</sup>		Factors <sup>(2)</sup>		Dynamic <sup>(3)</sup>		Factors <sup>(2)</sup>		Static C <sub>0</sub>	Inner	Outer
			C <sub>1</sub>	e	Y	C <sub>90</sub>	C <sub>a90</sub>	K	N	N			
mm in.	mm in.	mm in.	N lbf			N lbf	N lbf		N lbf				
57.150 2.2500	87.312 3.4375	18.258 0.7188	62700 14100	0.39	1.54	16300 3650	10800 2430	1.50	95600 21500		L507949	L507910	
57.150 2.2500	96.838 3.8125	21.000 0.8268	108000 24200	0.35	1.69	28000 6280	16900 3810	1.65	107000 24100		387	382A	
57.150 2.2500	96.838 3.8125	21.000 0.8268	108000 24200	0.35	1.69	28000 6280	16900 3810	1.65	107000 24100		387A	382A	
57.150 2.2500	96.838 3.8125	21.000 0.8268	108000 24200	0.35	1.69	28000 6280	16900 3810	1.65	107000 24100		387-S	382A	
57.150 2.2500	96.838 3.8125	21.001 0.8268	108000 24200	0.35	1.69	28000 6280	16900 3810	1.65	107000 24100		387AS	382A	
57.150 2.2500	96.838 3.8125	24.608 0.9688	123000 27700	0.40	1.49	32000 7180	22000 4950	1.45	142000 32000		28682	28621	
57.150 2.2500	96.838 3.8125	25.400 1.0000	108000 24200	0.35	1.69	28000 6280	16900 3810	1.65	107000 24100		387A	382-S	
57.150 2.2500	97.630 3.8437	24.608 0.9688	123000 27700	0.40	1.49	32000 7180	22000 4950	1.45	142000 32000		28682	28622	
57.150 2.2500	98.425 3.8750	21.000 0.8268	108000 24200	0.35	1.69	28000 6280	16900 3810	1.65	107000 24100		387	382	
57.150 2.2500	98.425 3.8750	21.000 0.8268	108000 24200	0.35	1.69	28000 6280	16900 3810	1.65	107000 24100		387A	382	
57.150 2.2500	98.425 3.8750	21.000 0.8268	108000 24200	0.35	1.69	28000 6280	16900 3810	1.65	107000 24100		387-S	382	
57.150 2.2500	98.425 3.8750	21.000 0.8268	108000 24200	0.35	1.69	28000 6280	16900 3810	1.65	107000 24100		387AS	382	
57.150 2.2500	98.425 3.8750	24.608 0.9688	123000 27700	0.40	1.49	32000 7180	22000 4950	1.45	142000 32000		28682	28623	
57.150 2.2500	100.000 3.9370	21.000 0.8268	108000 24200	0.35	1.69	28000 6280	16900 3810	1.65	107000 24100		387A	383A	
57.150 2.2500	100.000 3.9370	25.400 1.0000	108000 24200	0.35	1.69	28000 6280	16900 3810	1.65	107000 24100		387	383X	
57.150 2.2500	104.775 4.1250	30.162 1.1875	161000 36100	0.34	1.79	41700 9370	23900 5380	1.74	166000 37200		462	453X	
57.150 2.2500	104.775 4.1250	30.162 1.1875	161000 36100	0.34	1.79	41700 9370	23900 5380	1.74	166000 37200		469	453X	

<sup>(1)</sup>Based on 1 x 10<sup>6</sup> revolutions L<sub>10</sub> life, for the ISO life-calculation method.

<sup>(2)</sup>Consult your Timken engineer for instructions on use or review the Timken Engineering Manual on timken.com/catalogs.

<sup>(3)</sup>Based on 90 x 10<sup>6</sup> revolutions L<sub>10</sub> life, for The Timken Company life-calculation method. C<sub>90</sub> and C<sub>a90</sub> are radial and thrust values.

Bearing Dimensions											Geometry Factors			Bearing Weight
Width B	Width C	Eff. Ctr. a <sup>(4)</sup>	Shaft			Housing			Cage		G <sub>1</sub>	G <sub>2</sub>	C <sub>g</sub>	
			Max Shaft Fillet Radius R <sup>(5)</sup>	Backing Shoulder Dia. d <sub>a</sub> d <sub>b</sub>		Max Housing Fillet Radius r <sup>(5)</sup>	Backing Shoulder Dia. D <sub>a</sub> D <sub>b</sub>		A <sub>a</sub> <sup>(6)</sup>	A <sub>b</sub> <sup>(7)</sup>				
mm in.	mm in.	mm in.	mm in.	mm in.	mm in.	mm in.	mm in.	mm in.	mm in.	mm in.				kg lbs.
18.258 0.7188	14.288 0.5625	-0.8 -0.03	1.5 0.06	62.0 2.44	65.0 2.56	1.5 0.06	83.0 3.27	79.0 3.11	0.3 0.01	2.0 0.08	46.1	38.5	0.0914	0.39 0.85
21.946 0.8640	15.875 0.6250	-3.0 -0.12	2.3 0.09	63.0 2.48	67.0 2.64	0.8 0.03	92.0 3.62	89.0 3.50	1.1 0.04	2.0 0.08	42.0	15.7	0.0859	0.59 1.30
21.946 0.8640	15.875 0.6250	-3.0 -0.12	3.5 0.14	63.0 2.48	70.0 2.76	0.8 0.03	92.0 3.62	89.0 3.50	1.1 0.04	2.0 0.08	42.0	15.7	0.0859	0.59 1.30
21.946 0.8640	15.875 0.6250	-3.0 -0.12	0.8 0.03	63.0 2.48	64.0 2.52	0.8 0.03	92.0 3.62	89.0 3.50	1.1 0.04	2.0 0.08	42.0	15.7	0.0859	0.59 1.31
21.946 0.8640	15.875 0.6250	-3.0 -0.12	5.0 0.20	63.0 2.48	73.0 2.87	0.8 0.03	92.0 3.62	89.0 3.50	1.1 0.04	2.0 0.08	42.0	15.7	0.0859	0.59 1.29
24.608 0.9688	19.446 0.7656	-3.3 -0.13	3.5 0.14	63.0 2.48	70.0 2.76	0.8 0.03	92.0 3.62	88.0 3.46	1.5 0.06	1.8 0.08	54.0	22.6	0.0979	0.71 1.57
21.946 0.8640	20.274 0.7982	-3.0 -0.12	3.5 0.14	63.0 2.48	70.0 2.76	2.3 0.09	91.0 3.58	87.0 3.43	1.1 0.04	2.0 0.08	42.0	15.7	0.0859	0.66 1.45
24.608 0.9688	19.446 0.7656	-3.3 -0.13	3.5 0.14	63.0 2.48	70.0 2.76	0.8 0.03	92.0 3.62	88.0 3.46	1.5 0.06	1.8 0.08	54.0	22.6	0.0979	0.73 1.61
21.946 0.8640	17.826 0.7018	-3.0 -0.12	2.3 0.09	63.0 2.48	67.0 2.64	0.8 0.03	92.0 3.62	90.0 3.54	1.1 0.04	2.0 0.08	42.0	15.7	0.0859	0.64 1.41
21.946 0.8640	17.826 0.7018	-3.0 -0.12	3.5 0.14	63.0 2.48	70.0 2.76	0.8 0.03	92.0 3.62	90.0 3.54	1.1 0.04	2.0 0.08	42.0	15.7	0.0859	0.64 1.40
21.946 0.8640	17.826 0.7018	-3.0 -0.12	0.8 0.03	63.0 2.48	64.0 2.52	0.8 0.03	92.0 3.62	90.0 3.54	1.1 0.04	2.0 0.08	42.0	15.7	0.0859	0.64 1.41
21.946 0.8640	17.826 0.7018	-3.0 -0.12	5.0 0.20	63.0 2.48	73.0 2.87	0.8 0.03	92.0 3.62	90.0 3.54	1.1 0.04	2.0 0.08	42.0	15.7	0.0859	0.64 1.39
24.608 0.9688	19.446 0.7656	-3.3 -0.13	3.5 0.14	63.0 2.48	70.0 2.76	0.8 0.03	93.0 3.66	88.0 3.46	1.5 0.06	1.8 0.08	54.0	22.6	0.0979	0.75 1.65
21.946 0.8640	17.826 0.7018	-3.0 -0.12	3.5 0.14	63.0 2.48	70.0 2.76	2.0 0.08	93.0 3.66	89.0 3.50	1.1 0.04	2.0 0.08	42.0	15.7	0.0859	0.67 1.47
21.946 0.8640	22.225 0.8750	-3.0 -0.12	2.3 0.09	63.0 2.48	67.0 2.64	1.3 0.05	93.0 3.66	89.0 3.50	1.1 0.04	2.0 0.08	42.0	15.7	0.0859	0.76 1.67
29.317 1.1542	24.605 0.9687	-7.1 -0.28	2.3 0.09	63.0 2.48	67.0 2.64	3.3 0.13	98.0 3.86	92.0 3.62	2.1 0.08	1.4 0.06	58.6	17.1	0.0946	1.05 2.30
29.317 1.1542	24.605 0.9687	-7.1 -0.28	3.5 0.14	68.0 2.68	72.0 2.83	3.3 0.13	98.0 3.86	92.0 3.62	2.1 0.08	1.4 0.06	58.6	17.1	0.0946	1.05 2.30

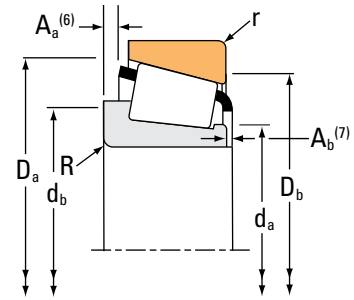
(4) Negative value indicates effective center inside cone (inner-ring) backface.  
 (5) These maximum fillet radii will be cleared by the bearing corners.  
 (6) Negative value indicates cage extends beyond cone (inner-ring) backface.  
 (7) Negative value indicates cage that does not extend beyond cone (inner-ring) front face.

Continued on next page.

# TAPERED ROLLER BEARINGS

## SINGLE-ROW • TYPE TS

### TYPE TS



Bearing Dimensions			Load Ratings							Part Number		
Bore d	O.D. D	Width T	Dynamic <sup>(1)</sup>		Factors <sup>(2)</sup>		Dynamic <sup>(3)</sup>		Factors <sup>(2)</sup>	Static	Inner	Outer
			C <sub>1</sub>	e	Y	C <sub>90</sub>	C <sub>a90</sub>	K	C <sub>0</sub>			
mm in.	mm in.	mm in.	N lbf			N lbf	N lbf			N lbf		
57.150 2.2500	104.775 4.1250	30.162 1.1875	153000 34500	0.33	1.80	39700 8930	22600 5090	1.76		189000 42600	45290	45220
57.150 2.2500	104.775 4.1250	30.162 1.1875	161000 36100	0.34	1.79	41700 9370	23900 5380	1.74		166000 37200	462A	453X
57.150 2.2500	104.775 4.1250	30.162 1.1875	153000 34500	0.33	1.80	39700 8930	22600 5090	1.76		189000 42600	45289	45221
57.150 2.2500	104.775 4.1250	30.162 1.1875	153000 34500	0.33	1.80	39700 8930	22600 5090	1.76		189000 42600	45290	45221
57.150 2.2500	104.775 4.1250	30.162 1.1875	153000 34500	0.33	1.80	39700 8930	22600 5090	1.76		189000 42600	45291	45220
57.150 2.2500	104.775 4.1250	30.162 1.1875	153000 34500	0.33	1.80	39700 8930	22600 5090	1.76		189000 42600	45289	45220
57.150 2.2500	104.775 4.1250	30.162 1.1875	153000 34500	0.33	1.80	39700 8930	22600 5090	1.76		189000 42600	45291	45221
57.150 2.2500	107.950 4.2500	27.783 1.0938	161000 36100	0.34	1.79	41700 9370	23900 5380	1.74		166000 37200	462	453A
57.150 2.2500	107.950 4.2500	27.783 1.0938	161000 36100	0.34	1.79	41700 9370	23900 5380	1.74		166000 37200	469	453A
57.150 2.2500	107.950 4.2500	27.783 1.0938	161000 36100	0.34	1.79	41700 9370	23900 5380	1.74		166000 37200	462	453AS
57.150 2.2500	107.950 4.2500	32.558 1.2818	161000 36100	0.34	1.79	41700 9370	23900 5380	1.74		166000 37200	462	452A
57.150 2.2500	110.000 4.3307	22.000 0.8661	98900 22200	0.40	1.49	25600 5760	17600 3970	1.45		125000 28100	390	394A
57.150 2.2500	110.000 4.3307	22.000 0.8661	98900 22200	0.40	1.49	25600 5760	17600 3970	1.45		125000 28100	390	394AS
57.150 2.2500	110.000 4.3307	27.795 1.0943	161000 36100	0.34	1.79	41700 9370	23900 5380	1.74		166000 37200	462	454
57.150 2.2500	112.712 4.4375	25.400 1.0000	111000 24800	0.49	1.23	28600 6440	23900 5370	1.20		166000 37200	29665	29620
57.150 2.2500	112.712 4.4375	26.967 1.0617	98900 22200	0.40	1.49	25600 5760	17600 3970	1.45		125000 28100	390	3920
57.150 2.2500	112.712 4.4375	30.162 1.1875	139000 31200	0.40	1.49	36000 8090	24800 5570	1.45		191000 43000	3979	3920

<sup>(1)</sup>Based on 1 x 10<sup>6</sup> revolutions L<sub>10</sub> life, for the ISO life-calculation method.

<sup>(2)</sup>Consult your Timken engineer for instructions on use or review the Timken Engineering Manual on timken.com/catalogs.

<sup>(3)</sup>Based on 90 x 10<sup>6</sup> revolutions L<sub>10</sub> life, for The Timken Company life-calculation method. C<sub>90</sub> and C<sub>a90</sub> are radial and thrust values.

Bearing Dimensions											Geometry Factors			Bearing Weight
Width B	Width C	Eff. Ctr. a <sup>(4)</sup>	Shaft			Housing			Cage		G <sub>1</sub>	G <sub>2</sub>	C <sub>g</sub>	
			Max Shaft Fillet Radius R <sup>(5)</sup>	Backing Shoulder Dia. d <sub>a</sub>	Shoulder Dia. d <sub>b</sub>	Max Housing Fillet Radius r <sup>(5)</sup>	Backing Shoulder Dia. D <sub>a</sub>	Shoulder Dia. D <sub>b</sub>	A <sub>a</sub> <sup>(6)</sup>	A <sub>b</sub> <sup>(7)</sup>				
mm in.	mm in.	mm in.	mm in.	mm in.	mm in.	mm in.	mm in.	mm in.	mm in.	mm in.				kg lbs.
30.958 1.2188	23.812 0.9375	-8.1 -0.32	2.3 0.09	65.0 2.56	68.0 2.68	3.3 0.13	99.0 3.90	93.0 3.66	2.1 0.08	1.8 0.07	63.5	16.9	0.0971	1.09 2.39
29.317 1.1542	24.605 0.9687	-7.1 -0.28	2.3 0.09	68.0 2.68	67.0 2.64	3.3 0.13	98.0 3.86	92.0 3.62	2.1 0.08	1.4 0.06	58.6	17.1	0.0946	1.04 2.28
30.958 1.2188	23.812 0.9375	-8.1 -0.32	0.8 0.03	65.0 2.56	65.0 2.56	0.8 0.03	99.0 3.90	95.0 3.74	2.1 0.08	1.8 0.07	63.5	16.9	0.0971	1.09 2.40
30.958 1.2188	23.812 0.9375	-8.1 -0.32	2.3 0.09	65.0 2.56	68.0 2.68	0.8 0.03	99.0 3.90	95.0 3.74	2.1 0.08	1.8 0.07	63.5	16.9	0.0971	1.09 2.40
30.958 1.2188	23.812 0.9375	-8.1 -0.32	6.4 0.25	65.0 2.56	76.0 2.99	3.3 0.13	99.0 3.90	93.0 3.66	2.1 0.08	1.8 0.07	63.5	16.9	0.0971	1.06 2.32
30.958 1.2188	23.812 0.9375	-8.1 -0.32	0.8 0.03	65.0 2.56	65.0 2.56	3.3 0.13	99.0 3.90	93.0 3.66	2.1 0.08	1.8 0.07	63.5	16.9	0.0971	1.09 2.39
30.958 1.2188	23.812 0.9375	-8.1 -0.32	6.4 0.25	65.0 2.56	76.0 2.99	0.8 0.03	99.0 3.90	95.0 3.74	2.1 0.08	1.8 0.07	63.5	16.9	0.0971	1.06 2.33
29.317 1.1542	22.225 0.8750	-7.1 -0.28	2.3 0.09	63.0 2.48	67.0 2.64	0.8 0.03	100.0 3.94	97.0 3.82	2.1 0.08	1.4 0.06	58.6	17.1	0.0946	1.10 2.42
29.317 1.1542	22.225 0.8750	-7.1 -0.28	3.5 0.14	68.0 2.68	72.0 2.83	0.8 0.03	100.0 3.94	97.0 3.82	2.1 0.08	1.4 0.06	58.6	17.1	0.0946	1.10 2.42
29.317 1.1542	22.225 0.8750	-7.1 -0.28	2.3 0.09	63.0 2.48	67.0 2.64	2.3 0.09	100.0 3.94	95.0 3.74	2.1 0.08	1.4 0.06	58.6	17.1	0.0946	1.10 2.42
29.317 1.1542	27.000 1.0630	-7.1 -0.28	2.3 0.09	63.0 2.48	67.0 2.64	3.3 0.13	100.0 3.94	93.0 3.66	2.1 0.08	1.4 0.06	58.6	17.1	0.0946	1.21 2.66
21.996 0.8660	18.824 0.7411	-0.8 -0.03	2.3 0.09	66.0 2.60	70.0 2.76	1.3 0.05	105.0 4.13	101.0 3.98	1.6 0.06	2.3 0.09	56.0	21.4	0.0984	0.94 2.07
21.996 0.8660	18.824 0.7411	-0.8 -0.03	2.3 0.09	66.0 2.60	70.0 2.76	3.3 0.13	104.5 4.11	99.0 3.90	1.6 0.06	2.3 0.09	56.0	21.4	0.0984	0.93 2.04
29.317 1.1542	27.000 1.0630	-7.1 -0.28	2.3 0.09	63.0 2.48	67.0 2.64	2.0 0.08	100.0 3.94	96.0 3.78	2.1 0.08	1.4 0.06	58.6	17.1	0.0946	1.23 2.70
25.400 1.0000	19.050 0.7500	1.0 0.04	3.5 0.14	69.0 2.72	75.0 2.95	3.3 0.13	109.0 4.29	101.0 3.98	2.3 0.09	1.5 0.06	77.7	43.3	0.1170	1.20 2.65
21.996 0.8660	23.812 0.9375	-0.8 -0.03	2.3 0.09	66.0 2.60	70.0 2.76	3.3 0.13	106.0 4.17	99.0 3.90	1.6 0.06	2.3 0.09	56.0	21.4	0.0984	1.13 2.49
30.048 1.1830	23.812 0.9375	-4.6 -0.18	3.5 0.14	66.0 2.60	72.0 2.83	3.3 0.13	106.0 4.17	99.0 3.90	2.2 0.08	1.2 0.05	75.2	21.3	0.1092	1.37 3.04

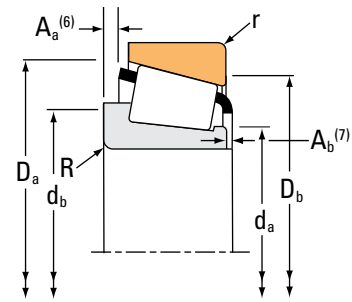
<sup>(4)</sup>Negative value indicates effective center inside cone (inner-ring) backface.  
<sup>(5)</sup>These maximum fillet radii will be cleared by the bearing corners.  
<sup>(6)</sup>Negative value indicates cage extends beyond cone (inner-ring) backface.  
<sup>(7)</sup>Negative value indicates cage that does not extend beyond cone (inner-ring) front face.

Continued on next page.

# TAPERED ROLLER BEARINGS

## SINGLE-ROW • TYPE TS

### TYPE TS



Bearing Dimensions			Load Ratings							Part Number			
Bore d	O.D. D	Width T	Dynamic <sup>(1)</sup>		Factors <sup>(2)</sup>		Dynamic <sup>(3)</sup>		Factors <sup>(2)</sup>		Static C <sub>0</sub>	Inner	Outer
			C <sub>1</sub>	e	Y	C <sub>90</sub>	C <sub>a90</sub>	K	N	N			
mm in.	mm in.	mm in.	N lbf			N lbf	N lbf		N lbf				
57.150 2.2500	112.712 4.4375	30.162 1.1875	167000 37500	0.34	1.77	43300 9730	25100 5650	1.72	224000 50300		39580	39520	
57.150 2.2500	112.712 4.4375	30.162 1.1875	167000 37500	0.34	1.77	43300 9730	25100 5650	1.72	224000 50300		39581	39520	
57.150 2.2500	112.712 4.4375	30.162 1.1875	167000 37500	0.34	1.77	43300 9730	25100 5650	1.72	224000 50300		39580	39521	
57.150 2.2500	117.475 4.6250	33.338 1.3125	177000 39700	0.63	0.96	45800 10300	49100 11000	0.93	166000 37300		66225	66462	
57.150 2.2500	120.650 4.7500	41.275 1.6250	207000 46600	0.31	1.91	53800 12100	28900 6510	1.86	244000 54800		623	612	
57.150 2.2500	120.650 4.7500	41.275 1.6250	207000 46600	0.31	1.91	53800 12100	28900 6510	1.86	244000 54800		623A	612	
57.150 2.2500	120.650 4.7500	41.275 1.6250	207000 46600	0.31	1.91	53800 12100	28900 6510	1.86	244000 54800		623	612-S	
57.150 2.2500	122.238 4.8125	33.338 1.3125	155000 34800	0.67	0.90	40100 9010	45600 10300	0.88	178000 39900		66587	66520	
57.150 2.2500	123.825 4.8750	36.512 1.4375	214000 48200	0.74	0.81	55500 12500	70100 15800	0.79	208000 46800		72225C	72487	
57.150 2.2500	123.825 4.8750	38.100 1.5000	226000 50800	0.35	1.73	58600 13200	34700 7810	1.69	248000 55700		555-S	552	
57.150 2.2500	123.825 4.8750	38.100 1.5000	226000 50800	0.35	1.73	58600 13200	34700 7810	1.69	248000 55700		555-S	552A	
57.150 2.2500	125.000 4.9213	38.100 1.5000	226000 50800	0.35	1.73	58600 13200	34700 7810	1.69	248000 55700		555-S	553A	
57.150 2.2500	127.000 5.0000	44.450 1.7500	243000 54700	0.49	1.23	63100 14200	52700 11800	1.20	297000 66700		65225	65500	
57.150 2.2500	129.944 5.1159	38.100 1.5000	226000 50800	0.35	1.73	58600 13200	34700 7810	1.69	248000 55700		555-S	553-SA	
57.150 2.2500	135.755 5.3447	53.975 2.1250	321000 72300	0.32	1.85	83300 18700	46300 10400	1.80	404000 90900		6375	6320	
57.150 2.2500	135.755 5.3447	53.975 2.1250	321000 72300	0.32	1.85	83300 18700	46300 10400	1.80	404000 90900		6387	6320	
57.150 2.2500	136.525 5.3750	36.512 1.4375	237000 53200	0.87	0.69	61300 13800	90900 20400	0.67	234000 52600		78225C	78537	

<sup>(1)</sup>Based on 1 x 10<sup>6</sup> revolutions L<sub>10</sub> life, for the ISO life-calculation method.

<sup>(2)</sup>Consult your Timken engineer for instructions on use or review the Timken Engineering Manual on timken.com/catalogs.

<sup>(3)</sup>Based on 90 x 10<sup>6</sup> revolutions L<sub>10</sub> life, for The Timken Company life-calculation method. C<sub>90</sub> and C<sub>a90</sub> are radial and thrust values.



Bearing Dimensions											Geometry Factors			Bearing Weight
Width B	Width C	Eff. Ctr. a <sup>(4)</sup>	Shaft			Housing			Cage		G <sub>1</sub>	G <sub>2</sub>	C <sub>g</sub>	
			Max Shaft Fillet Radius R <sup>(5)</sup>	Backing Shoulder Dia. d <sub>a</sub>	Backing Shoulder Dia. d <sub>b</sub>	Max Housing Fillet Radius r <sup>(5)</sup>	Backing Shoulder Dia. D <sub>a</sub>	Backing Shoulder Dia. D <sub>b</sub>	A <sub>a</sub> <sup>(6)</sup>	A <sub>b</sub> <sup>(7)</sup>				
mm in.	mm in.	mm in.	mm in.	mm in.	mm in.	mm in.	mm in.	mm in.	mm in.	mm in.				kg lbs.
30.162 1.1875	23.812 0.9375	-6.6 -0.26	3.5 0.14	68.0 2.68	74.0 2.91	3.3 0.13	107.0 4.21	101.0 3.98	1.6 0.06	2.7 0.11	84.3	23.7	0.1074	1.38 3.04
30.162 1.1875	23.812 0.9375	-6.6 -0.26	8.0 0.31	66.0 2.60	81.0 3.19	3.3 0.13	107.0 4.21	101.0 3.98	1.6 0.06	2.7 0.11	84.3	23.7	0.1074	1.37 3.01
30.162 1.1875	23.812 0.9375	-6.6 -0.26	3.5 0.14	68.0 2.68	74.0 2.91	0.8 0.03	107.0 4.21	103.0 4.06	1.6 0.06	2.7 0.11	84.3	23.7	0.1074	1.38 3.06
31.750 1.2500	23.812 0.9375	-0.3 -0.01	3.5 0.14	68.9 2.71	76.0 2.99	3.3 0.13	111.0 4.37	100.0 3.94	5.0 0.19	2.0 0.08	50.2	16.4	0.0751	1.50 3.31
41.275 1.6250	31.750 1.2500	-14.0 -0.55	3.5 0.14	66.0 2.60	72.0 2.83	3.3 0.13	110.0 4.33	105.0 4.13	3.8 0.15	1.9 0.08	75.9	16.2	0.0694	2.09 4.62
41.275 1.6250	31.750 1.2500	-14.0 -0.55	6.4 0.25	66.0 2.60	78.0 3.07	3.3 0.13	110.0 4.33	105.0 4.13	3.8 0.15	1.9 0.08	75.9	16.2	0.0694	2.07 4.57
41.275 1.6250	31.750 1.2500	-14.0 -0.55	3.5 0.14	66.0 2.60	72.0 2.83	0.8 0.03	110.0 4.33	107.0 4.21	3.8 0.15	1.9 0.08	75.9	16.2	0.0694	2.10 4.65
31.750 1.2500	23.812 0.9375	2.0 0.08	3.5 0.14	71.0 2.80	77.0 3.03	3.3 0.13	116.0 4.57	105.0 4.13	5.2 0.20	2.0 0.08	57.0	18.3	0.0797	1.69 3.74
32.791 1.2910	25.400 1.0000	2.0 0.08	3.5 0.14	67.0 2.64	81.0 3.19	3.3 0.13	116.0 4.57	102.0 4.02	4.7 0.18	4.4 0.18	57.4	15.9	0.0825	1.98 4.37
36.678 1.4440	33.338 1.3125	-9.4 -0.37	3.5 0.14	70.0 2.76	76.0 2.99	3.3 0.13	116.0 4.57	109.0 4.29	2.3 0.09	1.3 0.05	91.0	21.1	0.1108	2.21 4.85
36.678 1.4440	30.162 1.1875	-9.4 -0.37	3.5 0.14	70.0 2.76	76.0 2.99	3.3 0.13	116.0 4.57	109.0 4.29	2.3 0.09	1.3 0.05	91.0	21.1	0.1108	2.16 4.75
36.678 1.4440	30.162 1.1875	-9.4 -0.37	3.5 0.14	70.0 2.76	76.0 2.99	3.3 0.13	116.0 4.57	109.0 4.29	2.3 0.09	1.3 0.05	91.0	21.1	0.1108	2.21 4.87
44.450 1.7500	34.925 1.3750	-9.4 -0.37	3.5 0.14	71.0 2.79	80.0 3.15	3.3 0.13	119.0 4.69	107.0 4.21	4.1 0.16	1.1 0.05	83.2	17.2	0.0827	2.71 5.97
36.678 1.4440	30.162 1.1875	-9.4 -0.37	3.5 0.14	70.0 2.76	76.0 2.99	3.3 0.13	116.0 4.57	111.0 4.37	2.3 0.09	1.3 0.05	91.0	21.1	0.1108	2.45 5.38
56.007 2.2050	44.450 1.7500	-19.3 -0.76	4.3 0.17	72.0 2.83	80.0 3.15	3.3 0.13	126.0 4.96	117.0 4.61	4.0 0.15	0.5 0.02	123.5	22.4	0.0827	3.96 8.74
56.007 2.2050	44.450 1.7500	-19.3 -0.76	0.8 0.03	72.0 2.83	72.0 2.83	3.3 0.13	126.0 4.96	117.0 4.61	4.0 0.15	0.5 0.02	123.5	22.4	0.0827	3.97 8.77
33.236 1.3085	23.520 0.9260	8.4 0.33	3.5 0.14	77.5 3.05	86.0 3.39	3.3 0.13	130.0 5.12	115.0 4.53	6.3 0.25	4.9 0.20	71.3	17.6	0.0926	2.52 5.56

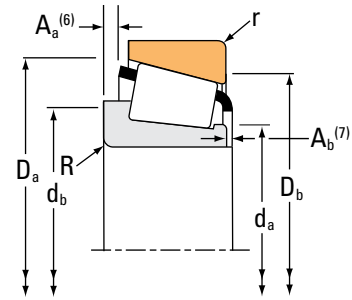
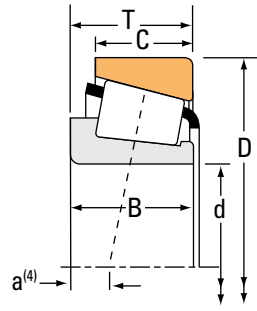
<sup>(4)</sup>Negative value indicates effective center inside cone (inner-ring) backface.  
<sup>(5)</sup>These maximum fillet radii will be cleared by the bearing corners.  
<sup>(6)</sup>Negative value indicates cage extends beyond cone (inner-ring) backface.  
<sup>(7)</sup>Negative value indicates cage that does not extend beyond cone (inner-ring) front face.

Continued on next page.

# TAPERED ROLLER BEARINGS

## SINGLE-ROW • TYPE TS

### TYPE TS



Bearing Dimensions			Load Ratings							Part Number			
Bore d	O.D. D	Width T	Dynamic <sup>(1)</sup>		Factors <sup>(2)</sup>		Dynamic <sup>(3)</sup>		Factors <sup>(2)</sup>		Static C <sub>0</sub>	Inner	Outer
			C <sub>1</sub>	e	Y	C <sub>90</sub>	C <sub>a90</sub>	K	N	N			
mm in.	mm in.	mm in.	N lbf			N lbf	N lbf		N lbf				
57.150 2.2500	136.525 5.3750	41.275 1.6250	233000 52400	0.36	1.66	60400 13600	37400 8420	1.61	298000 67000		635	632	
57.150 2.2500	140.030 5.5130	36.512 1.4375	203000 45600	0.87	0.69	52600 11800	77900 17500	0.67	193000 43400		78225	78551	
57.150 2.2500	140.030 5.5130	36.512 1.4375	237000 53200	0.87	0.69	61300 13800	90900 20400	0.67	234000 52600		78225C	78551	
57.150 2.2500	149.225 5.8750	53.975 2.1250	411000 92400	0.36	1.66	107000 24000	66000 14800	1.61	463000 104000		6455	6420	
57.150 2.2500	149.225 5.8750	53.975 2.1250	411000 92400	0.36	1.66	107000 24000	66000 14800	1.61	463000 104000		6465	6420	
57.150 2.2500	149.225 5.8750	53.975 2.1250	411000 92400	0.36	1.66	107000 24000	66000 14800	1.61	463000 104000		6465	6420A	
57.150 2.2500	152.400 6.0000	53.975 2.1250	339000 76100	0.49	1.23	87800 19700	73200 16500	1.20	423000 95000		HH814540	HH814510	
57.531 2.2650	96.838 3.8125	21.000 0.8268	108000 24200	0.35	1.69	28000 6280	16900 3810	1.65	107000 24100		388A	382A	
57.531 2.2650	98.425 3.8750	21.000 0.8268	108000 24200	0.35	1.69	28000 6280	16900 3810	1.65	107000 24100		388A	382	
57.531 2.2650	100.000 3.9370	21.000 0.8268	108000 24200	0.35	1.69	28000 6280	16900 3810	1.65	107000 24100		388A	383A	
58.737 2.3125	112.712 4.4375	30.162 1.1875	139000 31200	0.40	1.49	36000 8090	24800 5570	1.45	191000 43000		3981	3920	
58.737 2.3125	127.000 5.0000	44.450 1.7500	243000 54700	0.49	1.23	63100 14200	52700 11800	1.20	297000 66700		65231	65500	
59.530 2.3437	112.712 4.4375	30.162 1.1875	139000 31200	0.40	1.49	36000 8090	24800 5570	1.45	191000 43000		3978	3920	
59.880 2.3575	127.000 5.0000	44.450 1.7500	243000 54700	0.49	1.23	63100 14200	52700 11800	1.20	297000 66700		65235	65500	
59.931 2.3595	150.089 5.9090	44.450 1.7500	318000 71400	0.33	1.84	82400 18500	45900 10300	1.80	417000 93800		745	742	
59.977 2.3613	100.000 3.9370	25.400 1.0000	106000 23800	0.43	1.41	27500 6180	20000 4500	1.37	149000 33500		28980	28921	
59.977 2.3613	122.238 4.8125	33.338 1.3125	155000 34800	0.67	0.90	40100 9010	45600 10300	0.88	178000 39900		66586	66520	

<sup>(1)</sup>Based on 1 x 10<sup>6</sup> revolutions L<sub>10</sub> life, for the ISO life-calculation method.

<sup>(2)</sup>Consult your Timken engineer for instructions on use or review the Timken Engineering Manual on timken.com/catalogs.

<sup>(3)</sup>Based on 90 x 10<sup>6</sup> revolutions L<sub>10</sub> life, for The Timken Company life-calculation method. C<sub>90</sub> and C<sub>a90</sub> are radial and thrust values.

Bearing Dimensions											Geometry Factors			Bearing Weight
Width B	Width C	Eff. Ctr. a <sup>(4)</sup>	Shaft			Housing			Cage		G <sub>1</sub>	G <sub>2</sub>	C <sub>g</sub>	
			Max Shaft Fillet Radius R <sup>(5)</sup>	Backing Shoulder Dia. d <sub>a</sub> d <sub>b</sub>		Max Housing Fillet Radius r <sup>(5)</sup>	Backing Shoulder Dia. D <sub>a</sub> D <sub>b</sub>		A <sub>a</sub> <sup>(6)</sup>	A <sub>b</sub> <sup>(7)</sup>				
mm in.	mm in.	mm in.	mm in.	mm in.	mm in.	mm in.	mm in.	mm in.	mm in.	mm in.				kg lbs.
41.275 1.6250	31.750 1.2500	-11.2 -0.44	3.5 0.14	69.0 2.72	75.0 2.95	3.3 0.13	125.0 4.92	118.0 4.65	4.1 0.16	2.0 0.08	106.4	21.0	0.0814	3.02 6.66
33.236 1.3085	23.520 0.9260	7.9 0.31	3.5 0.14	77.0 3.03	83.0 3.27	2.3 0.09	132.0 5.20	117.0 4.61	6.9 0.27	4.2 0.17	62.6	19.1	0.0884	2.57 5.67
33.236 1.3085	23.520 0.9260	8.4 0.33	3.5 0.14	77.5 3.05	86.0 3.39	2.3 0.09	132.0 5.20	117.0 4.61	6.3 0.25	4.9 0.20	71.3	17.6	0.0926	2.66 5.88
54.229 2.1350	44.450 1.7500	-15.0 -0.59	3.5 0.14	75.0 2.95	81.0 3.19	3.3 0.13	140.0 5.51	129.0 5.08	2.7 0.10	0.7 0.03	158.3	29.1	0.0931	5.09 11.23
54.229 2.1350	44.450 1.7500	-15.0 -0.59	6.8 0.27	75.0 2.95	88.0 3.46	3.3 0.13	140.0 5.51	129.0 5.08	2.7 0.10	0.7 0.03	158.3	29.1	0.0931	5.07 11.18
54.229 2.1350	44.450 1.7500	-15.0 -0.59	6.8 0.27	75.0 2.95	88.0 3.46	0.8 0.03	140.0 5.51	131.0 5.16	2.7 0.10	0.7 0.03	158.3	29.1	0.0931	5.09 11.22
57.150 2.2500	41.275 1.6250	-12.2 -0.48	3.5 0.14	81.0 3.19	87.0 3.43	3.3 0.13	143.0 5.63	130.0 5.12	5.2 0.20	0.2 0.01	129.7	23.6	0.0957	5.21 11.48
21.946 0.8640	15.875 0.6250	-3.0 -0.12	3.5 0.14	63.0 2.48	70.0 2.76	0.8 0.03	92.0 3.62	89.0 3.50	1.1 0.04	2.0 0.08	42.0	15.7	0.0859	0.58 1.29
21.946 0.8640	17.826 0.7018	-3.0 -0.12	3.5 0.14	63.0 2.48	70.0 2.76	0.8 0.03	92.0 3.62	90.0 3.54	1.1 0.04	2.0 0.08	42.0	15.7	0.0859	0.63 1.39
21.946 0.8640	17.826 0.7018	-3.0 -0.12	3.5 0.14	63.0 2.48	70.0 2.76	2.0 0.08	93.0 3.66	89.0 3.50	1.1 0.04	2.0 0.08	42.0	15.7	0.0859	0.66 1.46
30.048 1.1830	23.812 0.9375	-4.6 -0.18	3.5 0.14	67.0 2.64	73.0 2.87	3.3 0.13	106.0 4.17	99.0 3.90	2.2 0.08	1.2 0.05	75.2	21.3	0.1092	1.34 2.96
44.450 1.7500	34.925 1.3750	-9.4 -0.37	3.5 0.14	71.0 2.79	81.0 3.19	3.3 0.13	119.0 4.69	107.0 4.21	4.1 0.16	1.1 0.05	83.2	17.2	0.0827	2.66 5.86
30.048 1.1830	23.812 0.9375	-4.6 -0.18	1.5 0.06	68.0 2.68	70.0 2.76	3.3 0.13	106.0 4.17	99.0 3.90	2.2 0.08	1.2 0.05	75.2	21.3	0.1092	1.33 2.94
44.450 1.7500	34.925 1.3750	-9.4 -0.37	3.5 0.14	71.0 2.79	82.0 3.23	3.3 0.13	119.0 4.69	107.0 4.21	4.1 0.16	1.1 0.05	83.2	17.2	0.0827	2.63 5.78
46.672 1.8375	36.512 1.4375	-11.9 -0.47	3.5 0.14	75.0 2.95	81.0 3.19	3.3 0.13	142.0 5.59	134.0 5.28	1.8 0.07	1.3 0.05	159.6	26.3	0.0898	4.29 9.45
25.400 1.0000	19.845 0.7813	-2.5 -0.10	3.5 0.14	67.0 2.64	73.0 2.87	3.3 0.13	96.0 3.78	89.0 3.50	2.0 0.07	1.4 0.06	60.1	24.5	0.1032	0.75 1.67
31.750 1.2500	23.812 0.9375	2.0 0.08	1.5 0.06	73.0 2.87	75.0 2.95	3.3 0.13	116.0 4.57	105.0 4.13	5.2 0.20	2.0 0.08	57.0	18.3	0.0797	1.63 3.61

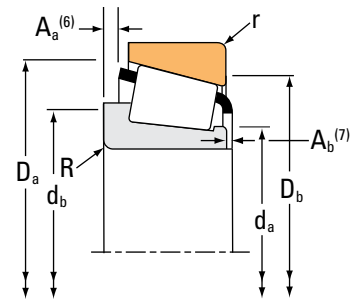
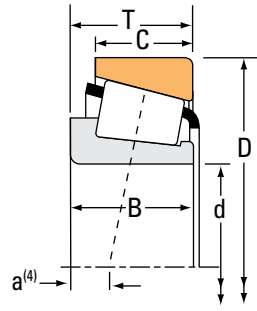
(4) Negative value indicates effective center inside cone (inner-ring) backface.  
 (5) These maximum fillet radii will be cleared by the bearing corners.  
 (6) Negative value indicates cage extends beyond cone (inner-ring) backface.  
 (7) Negative value indicates cage that does not extend beyond cone (inner-ring) front face.

Continued on next page.

# TAPERED ROLLER BEARINGS

## SINGLE-ROW • TYPE TS

### TYPE TS



Bearing Dimensions			Load Ratings							Part Number		
Bore d	O.D. D	Width T	Dynamic <sup>(1)</sup>		Factors <sup>(2)</sup>		Dynamic <sup>(3)</sup>		Factors <sup>(2)</sup>	Static	Inner	Outer
			C <sub>1</sub>	e	Y	C <sub>90</sub>	C <sub>a90</sub>	K	C <sub>0</sub>			
mm in.	mm in.	mm in.	N lbf			N lbf	N lbf		N lbf			
59.987 2.3617	104.775 4.1250	21.433 0.8438	115000 25800	0.39	1.55	29700 6680	19700 4440	1.51	120000 27000		39236	39412
59.987 2.3617	109.985 4.3301	29.751 1.1713	139000 31200	0.40	1.49	36000 8090	24800 5570	1.45	191000 43000		3977X	3921XA
59.987 2.3617	110.058 4.3330	22.000 0.8661	115000 25800	0.39	1.55	29700 6680	19700 4440	1.51	120000 27000		39236	39433
59.987 2.3617	112.712 4.4375	30.162 1.1875	139000 31200	0.40	1.49	36000 8090	24800 5570	1.45	191000 43000		3977X	3920
59.987 2.3617	125.000 4.9213	38.100 1.5000	191000 42900	0.35	1.73	49400 11100	29300 6590	1.69	248000 55700		558-S	553A
59.987 2.3617	127.000 5.0000	36.512 1.4375	229000 51500	0.50	1.20	59400 13400	51100 11500	1.16	256000 57600		HM813839	HM813810
59.987 2.3617	129.944 5.1159	38.100 1.5000	191000 42900	0.35	1.73	49400 11100	29300 6590	1.69	248000 55700		558-S	553-SA
59.987 2.3617	130.175 5.1250	34.100 1.3425	198000 44400	0.82	0.73	51200 11500	71900 16200	0.71	183000 41100		HM911244	HM911210
59.987 2.3617	134.983 5.3143	33.450 1.3169	198000 44400	0.82	0.73	51200 11500	71900 16200	0.71	183000 41100		HM911244	HM911216
59.987 2.3617	146.050 5.7500	41.275 1.6250	273000 61300	0.78	0.77	70700 15900	94700 21300	0.75	256000 57500		H913840	H913810
60.000 2.3622	95.000 3.7402	24.000 0.9449	97600 21900	0.40	1.49	25300 5690	17400 3910	1.45	135000 30400		JLM508748	JLM508710
60.000 2.3622	100.000 3.9370	21.000 0.8268	87300 19600	0.47	1.27	22600 5090	18300 4120	1.24	101000 22800		JP6049	JP6010
60.000 2.3622	107.950 4.2500	25.400 1.0000	131000 29400	0.46	1.31	33800 7610	26600 5970	1.27	161000 36300		29580	29520
60.000 2.3622	107.950 4.2500	25.400 1.0000	131000 29400	0.46	1.31	33800 7610	26600 5970	1.27	161000 36300		29582	29520
60.000 2.3622	107.950 4.2500	25.400 1.0000	131000 29400	0.46	1.31	33800 7610	26600 5970	1.27	161000 36300		29582	29522
60.000 2.3622	110.000 4.3307	22.000 0.8661	98900 22200	0.40	1.49	25600 5760	17600 3970	1.45	125000 28100		397	394AS
60.000 2.3622	110.000 4.3307	22.000 0.8661	98900 22200	0.40	1.49	25600 5760	17600 3970	1.45	125000 28100		397	394A

<sup>(1)</sup>Based on 1 x 10<sup>6</sup> revolutions L<sub>10</sub> life, for the ISO life-calculation method.

<sup>(2)</sup>Consult your Timken engineer for instructions on use or review the Timken Engineering Manual on timken.com/catalogs.

<sup>(3)</sup>Based on 90 x 10<sup>6</sup> revolutions L<sub>10</sub> life, for The Timken Company life-calculation method. C<sub>90</sub> and C<sub>a90</sub> are radial and thrust values.

Bearing Dimensions											Geometry Factors			Bearing Weight
Width B	Width C	Eff. Ctr. a <sup>(4)</sup>	Shaft			Housing			Cage		G <sub>1</sub>	G <sub>2</sub>	C <sub>g</sub>	
			Max Shaft Fillet Radius R <sup>(5)</sup>	Backing Shoulder Dia. d <sub>a</sub>	Backing Shoulder Dia. d <sub>b</sub>	Max Housing Fillet Radius r <sup>(5)</sup>	Backing Shoulder Dia. D <sub>a</sub>	Backing Shoulder Dia. D <sub>b</sub>	A <sub>a</sub> <sup>(6)</sup>	A <sub>b</sub> <sup>(7)</sup>				
mm in.	mm in.	mm in.	mm in.	mm in.	mm in.	mm in.	mm in.	mm in.	mm in.	mm in.				kg lbs.
22.000 0.8661	15.875 0.6250	-1.5 -0.06	2.3 0.09	67.0 2.64	71.0 2.80	2.0 0.08	100.0 3.94	96.0 3.78	1.6 0.06	2.4 0.10	51.7	19.5	0.0947	0.74 1.62
28.000 1.1024	23.812 0.9375	-4.6 -0.18	2.3 0.09	68.0 2.68	72.0 2.83	0.5 0.02	104.6 4.12	100.0 3.94	2.2 0.08	3.2 0.13	75.2	21.3	0.1092	1.20 2.65
22.000 0.8661	17.236 0.6786	-1.5 -0.06	2.3 0.09	67.0 2.64	71.0 2.80	2.3 0.09	103.0 4.06	98.0 3.86	1.6 0.06	2.4 0.10	51.7	19.5	0.0947	0.86 1.91
28.000 1.1024	23.812 0.9375	-4.6 -0.18	2.3 0.09	68.0 2.68	72.0 2.83	3.3 0.13	106.0 4.17	99.0 3.90	2.2 0.08	3.2 0.13	75.2	21.3	0.1092	1.29 2.85
36.678 1.4440	30.162 1.1875	-9.4 -0.37	3.5 0.14	69.0 2.72	75.0 2.95	3.3 0.13	116.0 4.57	109.0 4.29	2.3 0.09	1.3 0.05	91.0	21.1	0.1108	2.13 4.69
36.512 1.4375	26.988 1.0625	-3.8 -0.15	3.5 0.14	75.0 2.95	82.0 3.23	3.3 0.13	121.0 4.76	111.0 4.37	4.0 0.15	1.3 0.06	91.7	22.9	0.1252	2.18 4.82
36.678 1.4440	30.162 1.1875	-9.4 -0.37	3.5 0.14	69.0 2.72	75.0 2.95	3.3 0.13	116.0 4.57	111.0 4.37	2.3 0.09	1.3 0.05	91.0	21.1	0.1108	2.37 5.20
30.924 1.2175	23.812 0.9375	7.9 0.31	3.5 0.14	74.4 2.93	84.0 3.31	3.3 0.13	123.6 4.87	109.0 4.29	4.9 0.19	4.3 0.17	56.4	16.5	0.0842	1.99 4.40
30.924 1.2175	21.948 0.8641	7.9 0.31	3.5 0.14	74.4 2.93	84.0 3.31	3.5 0.14	123.0 4.84	112.0 4.41	4.9 0.19	4.3 0.17	56.4	16.5	0.0842	2.12 4.67
39.688 1.5625	25.400 1.0000	4.3 0.17	3.5 0.14	82.0 3.23	97.0 3.82	3.3 0.13	138.0 5.43	124.0 4.88	8.2 0.32	3.6 0.14	78.5	17.3	0.0927	3.19 7.02
24.000 0.9449	19.000 0.7480	-2.8 -0.11	5.0 0.20	66.0 2.60	75.0 2.95	2.5 0.10	91.0 3.58	85.0 3.35	1.4 0.05	1.6 0.07	54.2	27.5	0.0979	0.59 1.30
20.000 0.7874	15.500 0.6102	1.3 0.05	2.0 0.08	66.0 2.60	69.0 2.72	2.0 0.08	95.5 3.76	91.0 3.58	1.4 0.05	2.9 0.12	39.5	22.5	0.9220	0.59 1.31
25.400 1.0000	19.050 0.7500	-0.8 -0.03	3.5 0.14	68.0 2.68	75.0 2.95	3.3 0.13	103.0 4.06	96.0 3.78	2.1 0.08	1.4 0.06	70.3	25.9	0.1112	0.98 2.15
25.400 1.0000	19.050 0.7500	-0.8 -0.03	0.8 0.03	68.0 2.68	69.0 2.72	3.3 0.13	103.0 4.06	96.0 3.78	2.1 0.08	1.4 0.06	70.3	25.9	0.1112	0.99 2.18
25.400 1.0000	19.050 0.7500	-0.8 -0.03	0.8 0.03	68.0 2.68	69.0 2.72	0.8 0.03	103.0 4.06	98.0 3.86	2.1 0.08	1.4 0.06	70.3	25.9	0.1112	1.00 2.20
21.996 0.8660	18.824 0.7411	-0.8 -0.03	0.8 0.03	68.0 2.68	69.0 2.72	3.3 0.13	104.5 4.11	99.0 3.90	1.6 0.06	2.3 0.09	56.0	21.4	0.0984	0.89 1.95
21.996 0.8660	18.824 0.7411	-0.8 -0.03	0.8 0.03	68.0 2.68	69.0 2.72	1.3 0.05	105.0 4.13	101.0 3.98	1.6 0.06	2.3 0.09	56.0	21.4	0.0984	0.90 1.98

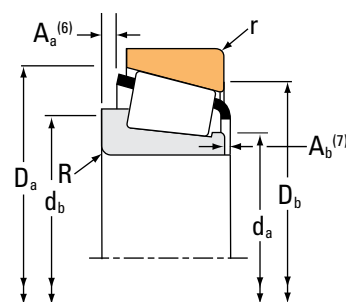
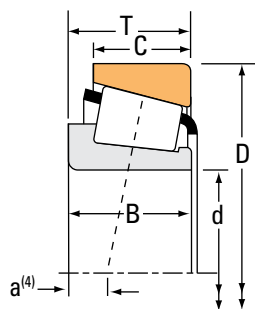
(4) Negative value indicates effective center inside cone (inner-ring) backface.  
 (5) These maximum fillet radii will be cleared by the bearing corners.  
 (6) Negative value indicates cage extends beyond cone (inner-ring) backface.  
 (7) Negative value indicates cage that does not extend beyond cone (inner-ring) front face.

Continued on next page.

# TAPERED ROLLER BEARINGS

## SINGLE-ROW • TYPE TS

### TYPE TS



Bearing Dimensions			Load Ratings							Part Number			
Bore d	O.D. D	Width T	Dynamic <sup>(1)</sup>		Factors <sup>(2)</sup>		Dynamic <sup>(3)</sup>		Factors <sup>(2)</sup>		Static C <sub>0</sub>	Inner	Outer
			C <sub>1</sub>	e	Y	C <sub>90</sub>	C <sub>a90</sub>	K	N	N			
mm in.	mm in.	mm in.	N lbf			N lbf	N lbf		N lbf				
60.000 2.3622	110.000 4.3307	25.400 1.0000	131000 29400	0.46	1.31	33800 7610	26600 5970	1.27	161000 36300		29580	29521	
60.000 2.3622	112.712 4.4375	30.162 1.1875	139000 31200	0.40	1.49	36000 8090	24800 5570	1.45	191000 43000		3977	3920	
60.000 2.3622	112.712 4.4375	30.162 1.1875	139000 31200	0.40	1.49	36000 8090	24800 5570	1.45	191000 43000		3977	3925	
60.000 2.3622	120.000 4.7244	29.794 1.1730	143000 32200	0.38	1.56	37200 8360	24500 5500	1.52	186000 41900		476	472	
60.000 2.3622	122.238 4.8125	33.338 1.3125	183000 41200	0.67	0.90	47500 10700	54100 12200	0.88	178000 39900		66585	66520	
60.000 2.3622	125.000 4.9213	37.000 1.4567	172000 38600	0.82	0.73	44500 10000	62500 14000	0.71	210000 47100		JW6049	JW6010	
60.325 2.3750	100.000 3.9370	25.400 1.0000	106000 23800	0.43	1.41	27500 6180	20000 4500	1.37	149000 33500		28985	28921A	
60.325 2.3750	100.000 3.9370	25.400 1.0000	106000 23800	0.43	1.41	27500 6180	20000 4500	1.37	149000 33500		28985	28921	
60.325 2.3750	101.600 4.0000	25.400 1.0000	106000 23800	0.43	1.41	27500 6180	20000 4500	1.37	149000 33500		28985	28920	
60.325 2.3750	112.712 4.4375	30.162 1.1875	139000 31200	0.40	1.49	36000 8090	24800 5570	1.45	191000 43000		3980	3920	
60.325 2.3750	112.712 4.4375	30.162 1.1875	139000 31200	0.40	1.49	36000 8090	24800 5570	1.45	191000 43000		3980	3925	
60.325 2.3750	122.238 4.8125	38.100 1.5000	267000 60000	0.34	1.78	69200 15600	40000 8990	1.73	279000 62700		HM212044	HM212011	
60.325 2.3750	122.238 4.8125	38.100 1.5000	267000 60000	0.34	1.78	69200 15600	40000 8990	1.73	279000 62700		HM212044	HM212010	
60.325 2.3750	122.238 4.8125	43.658 1.7188	280000 63000	0.36	1.67	72700 16300	44600 10000	1.63	327000 73500		5582	5535	
60.325 2.3750	122.238 4.8125	43.658 1.7188	280000 63000	0.36	1.67	72700 16300	44600 10000	1.63	327000 73500		5583	5535	
60.325 2.3750	123.825 4.8750	38.100 1.5000	226000 50800	0.35	1.73	58600 13200	34700 7810	1.69	248000 55700		558	552A	
60.325 2.3750	123.825 4.8750	38.100 1.5000	226000 50800	0.35	1.73	58600 13200	34700 7810	1.69	248000 55700		558	552	

<sup>(1)</sup>Based on 1 x 10<sup>6</sup> revolutions L<sub>10</sub> life, for the ISO life-calculation method.

<sup>(2)</sup>Consult your Timken engineer for instructions on use or review the Timken Engineering Manual on timken.com/catalogs.

<sup>(3)</sup>Based on 90 x 10<sup>6</sup> revolutions L<sub>10</sub> life, for The Timken Company life-calculation method. C<sub>90</sub> and C<sub>a90</sub> are radial and thrust values.

Bearing Dimensions											Geometry Factors			Bearing Weight
Width B	Width C	Eff. Ctr. a <sup>(4)</sup>	Shaft			Housing			Cage		G <sub>1</sub>	G <sub>2</sub>	C <sub>g</sub>	
			Max Shaft Fillet Radius R <sup>(5)</sup>	Backing Shoulder Dia. d <sub>a</sub> d <sub>b</sub>		Max Housing Fillet Radius r <sup>(5)</sup>	Backing Shoulder Dia. D <sub>a</sub> D <sub>b</sub>		A <sub>a</sub> <sup>(6)</sup>	A <sub>b</sub> <sup>(7)</sup>				
mm in.	mm in.	mm in.	mm in.	mm in.	mm in.	mm in.	mm in.	mm in.	mm in.	mm in.			kg lbs.	
25.400 1.0000	19.050 0.7500	-0.8 -0.03	3.5 0.14	68.0 2.68	75.0 2.95	1.3 0.05	104.0 4.09	99.0 3.90	2.1 0.08	1.4 0.06	70.3	25.9	0.1112	1.05 2.30
30.048 1.1830	23.812 0.9375	-4.6 -0.18	3.5 0.14	68.0 2.68	74.0 2.91	3.3 0.13	106.0 4.17	99.0 3.90	2.2 0.08	1.2 0.05	75.2	21.3	0.1092	1.31 2.90
30.048 1.1830	23.812 0.9375	-4.6 -0.18	3.5 0.14	68.0 2.68	74.0 2.91	0.8 0.03	106.0 4.17	101.0 3.98	2.2 0.08	1.2 0.05	75.2	21.3	0.1092	1.32 2.91
29.007 1.1420	24.237 0.9542	-4.1 -0.16	2.0 0.08	69.0 2.72	73.0 2.87	2.0 0.08	114.0 4.49	107.0 4.21	1.5 0.05	2.2 0.09	77.2	23.0	0.1083	1.55 3.40
31.750 1.2500	23.812 0.9375	2.0 0.08	3.5 0.14	73.0 2.87	79.0 3.11	3.3 0.13	116.0 4.57	105.0 4.13	5.2 0.20	2.0 0.08	57.0	18.3	0.0797	1.62 3.59
33.500 1.3189	26.000 1.0236	4.8 0.19	3.0 0.12	72.0 2.83	89.0 3.50	3.0 0.12	119.0 4.69	104.0 4.09	5.9 0.23	4.1 0.16	64.1	18.6	0.0883	2.02 4.46
25.400 1.0000	19.845 0.7813	-2.5 -0.10	3.5 0.14	67.0 2.64	73.0 2.87	0.8 0.03	96.0 3.78	91.0 3.58	2.0 0.07	1.4 0.06	60.1	24.5	0.1032	0.76 1.68
25.400 1.0000	19.845 0.7813	-2.5 -0.10	3.5 0.14	67.0 2.64	73.0 2.87	3.3 0.13	96.0 3.78	89.0 3.50	2.0 0.07	1.4 0.06	60.1	24.5	0.1032	0.74 1.65
25.400 1.0000	19.845 0.7813	-2.5 -0.10	3.5 0.14	67.0 2.64	73.0 2.87	3.3 0.13	97.0 3.82	90.0 3.54	2.0 0.07	1.4 0.06	60.1	24.5	0.1032	0.78 1.74
30.048 1.1830	23.812 0.9375	-4.6 -0.18	3.5 0.14	68.0 2.68	75.0 2.95	3.3 0.13	106.0 4.17	99.0 3.90	2.2 0.08	1.2 0.05	75.2	21.3	0.1092	1.30 2.89
30.048 1.1830	23.812 0.9375	-4.6 -0.18	3.5 0.14	68.0 2.68	75.0 2.95	0.8 0.03	106.0 4.17	101.0 3.98	2.2 0.08	1.2 0.05	75.2	21.3	0.1092	1.31 2.90
38.354 1.5100	29.718 1.1700	-10.9 -0.43	8.0 0.31	70.0 2.76	85.0 3.35	3.3 0.13	116.0 4.57	108.0 4.25	2.2 0.08	3.1 0.12	92.2	18.1	0.0759	2.03 4.45
38.354 1.5100	29.718 1.1700	-10.9 -0.43	8.0 0.31	70.0 2.76	85.0 3.35	1.5 0.06	116.0 4.57	110.0 4.33	2.2 0.08	3.1 0.12	92.2	18.1	0.0759	2.03 4.46
43.764 1.7230	36.512 1.4375	-12.2 -0.48	0.8 0.03	72.0 2.83	73.0 2.87	3.3 0.13	116.0 4.57	106.0 4.17	2.5 0.09	1.3 0.05	110.4	24.2	0.0825	2.40 5.30
43.764 1.7230	36.512 1.4375	-12.2 -0.48	3.5 0.14	72.0 2.83	78.0 3.07	3.3 0.13	116.0 4.57	106.0 4.17	2.5 0.09	1.3 0.05	110.4	24.2	0.0825	2.39 5.28
36.678 1.4440	30.162 1.1875	-9.4 -0.37	2.3 0.09	72.0 2.83	76.0 2.99	3.3 0.13	116.0 4.57	109.0 4.29	2.3 0.09	1.3 0.05	91.0	21.1	0.1108	2.08 4.57
36.678 1.4440	33.338 1.3125	-9.4 -0.37	2.3 0.09	72.0 2.83	76.0 2.99	3.3 0.13	116.0 4.57	109.0 4.29	2.3 0.09	1.3 0.05	91.0	21.1	0.1108	2.13 4.67

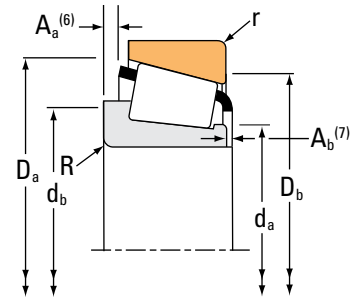
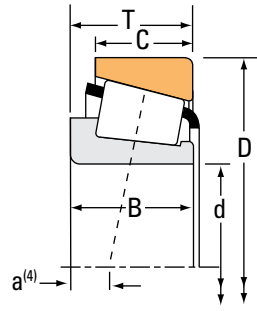
(4) Negative value indicates effective center inside cone (inner-ring) backface.  
 (5) These maximum fillet radii will be cleared by the bearing corners.  
 (6) Negative value indicates cage extends beyond cone (inner-ring) backface.  
 (7) Negative value indicates cage that does not extend beyond cone (inner-ring) front face.

Continued on next page.

# TAPERED ROLLER BEARINGS

## SINGLE-ROW • TYPE TS

### TYPE TS



Bearing Dimensions			Load Ratings							Part Number			
Bore d	O.D. D	Width T	Dynamic <sup>(1)</sup>		Factors <sup>(2)</sup>		Dynamic <sup>(3)</sup>		Factors <sup>(2)</sup>		Static C <sub>0</sub>	Inner	Outer
			C <sub>1</sub>	e	Y	C <sub>90</sub>	C <sub>a90</sub>	K	N	N			
mm in.	mm in.	mm in.	N lbf			N lbf	N lbf		N lbf				
60.325 2.3750	123.825 4.8750	38.100 1.5000	191000 42900	0.35	1.73	49400 11100	29300 6590	1.69	248000 55700			558A	552A
60.325 2.3750	127.000 5.0000	36.512 1.4375	229000 51500	0.50	1.20	59400 13400	51100 11500	1.16	256000 57600			HM813841	HM813811
60.325 2.3750	127.000 5.0000	36.512 1.4375	229000 51500	0.50	1.20	59400 13400	51100 11500	1.16	256000 57600			HM813841A	HM813811
60.325 2.3750	127.000 5.0000	36.512 1.4375	229000 51500	0.50	1.20	59400 13400	51100 11500	1.16	256000 57600			HM813841	HM813810
60.325 2.3750	127.000 5.0000	44.450 1.7500	243000 54700	0.49	1.23	63100 14200	52700 11800	1.20	297000 66700			65237	65500
60.325 2.3750	127.000 5.0000	44.450 1.7500	243000 54700	0.49	1.23	63100 14200	52700 11800	1.20	297000 66700			65237	65501
60.325 2.3750	127.000 5.0000	44.450 1.7500	243000 54700	0.49	1.23	63100 14200	52700 11800	1.20	297000 66700			65237A	65500
60.325 2.3750	130.175 5.1250	36.512 1.4375	198000 44400	0.82	0.73	51200 11500	71900 16200	0.71	183000 41100			HM911245	HM911210
60.325 2.3750	130.175 5.1250	41.275 1.6250	233000 52400	0.36	1.66	60400 13600	37400 8420	1.61	298000 67000			637	633
60.325 2.3750	135.755 5.3447	53.975 2.1250	321000 72300	0.32	1.85	83300 18700	46300 10400	1.80	404000 90900			6376	6320
60.325 2.3750	136.525 5.3750	36.512 1.4375	237000 53200	0.87	0.69	61300 13800	90900 20400	0.67	234000 52600			78238C	78537
60.325 2.3750	136.525 5.3750	41.275 1.6250	233000 52400	0.36	1.66	60400 13600	37400 8420	1.61	298000 67000			637	632
60.325 2.3750	136.525 5.3750	46.038 1.8125	319000 71700	0.47	1.27	82700 18600	67000 15100	1.24	405000 91000			H715332	H715311
60.325 2.3750	136.525 5.3750	46.038 1.8125	243000 54700	0.49	1.23	63100 14200	52700 11800	1.20	297000 66700			65237	65537
60.325 2.3750	139.700 5.5000	46.038 1.8125	319000 71700	0.47	1.27	82700 18600	67000 15100	1.24	405000 91000			H715332	H715310
60.325 2.3750	140.030 5.5130	36.512 1.4375	237000 53200	0.87	0.69	61300 13800	90900 20400	0.67	234000 52600			78238C	78551
60.325 2.3750	152.400 6.0000	52.705 2.0750	354000 79600	0.49	1.23	91800 20600	76600 17200	1.20	451000 101000			HH814542	HH814510

<sup>(1)</sup>Based on 1 x 10<sup>6</sup> revolutions L<sub>10</sub> life, for the ISO life-calculation method.

<sup>(2)</sup>Consult your Timken engineer for instructions on use or review the Timken Engineering Manual on timken.com/catalogs.

<sup>(3)</sup>Based on 90 x 10<sup>6</sup> revolutions L<sub>10</sub> life, for The Timken Company life-calculation method. C<sub>90</sub> and C<sub>a90</sub> are radial and thrust values.



Bearing Dimensions											Geometry Factors			Bearing Weight
Width B	Width C	Eff. Ctr. a <sup>(4)</sup>	Shaft			Housing			Cage		G <sub>1</sub>	G <sub>2</sub>	C <sub>g</sub>	
			Max Shaft Fillet Radius R <sup>(5)</sup>	Backing Shoulder Dia. d <sub>a</sub>	Shoulder Dia. d <sub>b</sub>	Max Housing Fillet Radius r <sup>(5)</sup>	Backing Shoulder Dia. D <sub>a</sub>	Shoulder Dia. D <sub>b</sub>	A <sub>a</sub> <sup>(6)</sup>	A <sub>b</sub> <sup>(7)</sup>				
mm in.	mm in.	mm in.	mm in.	mm in.	mm in.	mm in.	mm in.	mm in.	mm in.	mm in.				kg lbs.
36.678 1.4440	30.162 1.1875	-9.4 -0.37	3.5 0.14	69.0 2.72	76.0 2.99	3.3 0.13	116.0 4.57	109.0 4.29	2.3 0.09	1.3 0.05	91.0	21.1	0.1108	2.07 4.55
36.512 1.4375	26.988 1.0625	-3.8 -0.15	3.5 0.14	77.0 3.02	83.0 3.27	1.5 0.06	121.0 4.76	113.0 4.45	4.0 0.15	1.3 0.06	91.7	22.9	0.1252	2.17 4.80
36.512 1.4375	26.988 1.0625	-3.8 -0.15	1.5 0.06	76.0 2.99	78.0 3.07	1.5 0.06	121.0 4.76	113.0 4.45	4.0 0.15	1.3 0.06	91.7	22.9	0.1252	2.18 4.81
36.512 1.4375	26.988 1.0625	-3.8 -0.15	3.5 0.14	77.0 3.02	83.0 3.27	3.3 0.13	121.0 4.76	111.0 4.37	4.0 0.15	1.3 0.06	91.7	22.9	0.1252	2.17 4.80
44.450 1.7500	34.925 1.3750	-9.4 -0.37	3.5 0.14	71.0 2.80	87.0 3.43	3.3 0.13	119.0 4.69	107.0 4.21	4.1 0.16	1.1 0.05	83.2	17.2	0.0827	2.61 5.76
44.450 1.7500	34.925 1.3750	-9.4 -0.37	3.5 0.14	71.0 2.80	87.0 3.43	1.3 0.05	119.0 4.69	108.0 4.25	4.1 0.16	1.1 0.05	83.2	17.2	0.0827	2.61 5.76
44.450 1.7500	34.925 1.3750	-9.4 -0.37	1.5 0.06	71.1 2.80	78.0 3.07	3.3 0.13	119.0 4.69	107.0 4.21	4.1 0.16	1.1 0.05	83.2	17.2	0.0827	2.62 5.76
33.338 1.3125	23.812 0.9375	5.3 0.21	5.0 0.20	74.0 2.91	93.0 3.66	3.3 0.13	123.6 4.87	109.0 4.29	7.3 0.29	4.3 0.17	56.4	16.5	0.0842	2.06 4.55
41.275 1.6250	31.750 1.2500	-11.2 -0.44	3.5 0.14	72.0 2.83	78.0 3.07	3.3 0.13	124.0 4.88	116.0 4.57	4.1 0.16	2.0 0.08	106.4	21.0	0.0814	2.59 5.69
56.007 2.2050	44.450 1.7500	-19.3 -0.76	3.5 0.14	74.0 2.91	81.0 3.19	3.3 0.13	126.0 4.96	117.0 4.61	4.0 0.15	0.5 0.02	123.5	22.4	0.0827	3.83 8.46
33.236 1.3085	23.520 0.9260	8.4 0.33	5.0 0.20	77.5 3.05	91.0 3.58	3.3 0.13	130.0 5.12	115.0 4.53	6.3 0.25	4.9 0.20	71.3	17.6	0.0926	2.44 5.37
41.275 1.6250	31.750 1.2500	-11.2 -0.44	3.5 0.14	72.0 2.83	78.0 3.07	3.3 0.13	125.0 4.92	118.0 4.65	4.1 0.16	2.0 0.08	106.4	21.0	0.0814	2.93 6.45
46.038 1.8125	36.512 1.4375	-8.6 -0.34	3.5 0.14	80.0 3.15	86.0 3.39	3.3 0.13	132.0 5.20	118.0 4.65	4.1 0.16	2.0 0.08	147.1	33.5	0.0993	3.53 7.77
44.450 1.7500	36.512 1.4375	-9.4 -0.37	3.5 0.14	71.0 2.80	87.0 3.43	3.0 0.12	120.0 4.72	112.0 4.41	4.1 0.16	1.1 0.05	83.2	17.2	0.0827	3.23 7.12
46.038 1.8125	36.512 1.4375	-8.6 -0.34	3.5 0.14	80.0 3.15	86.0 3.39	3.3 0.13	133.0 5.24	120.0 4.72	4.1 0.16	2.0 0.08	147.1	33.5	0.0993	3.71 8.17
33.236 1.3085	23.520 0.9260	8.4 0.33	5.0 0.20	77.5 3.05	91.0 3.58	2.3 0.09	132.0 5.20	117.0 4.61	6.3 0.25	4.9 0.20	71.3	17.6	0.0926	2.58 5.69
52.705 2.0750	41.275 1.6250	-10.9 -0.43	3.5 0.14	83.0 3.27	89.0 3.50	3.3 0.13	143.0 5.63	130.0 5.12	4.0 0.16	2.5 0.10	135.7	24.6	0.0973	5.02 11.06

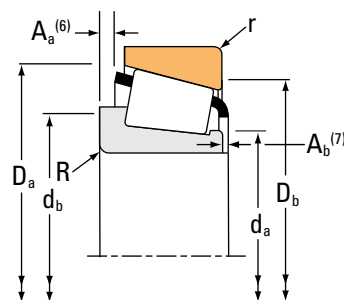
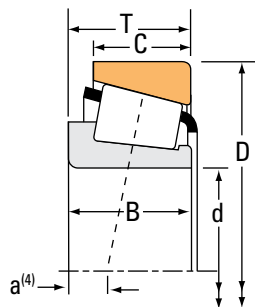
(4) Negative value indicates effective center inside cone (inner-ring) backface.  
 (5) These maximum fillet radii will be cleared by the bearing corners.  
 (6) Negative value indicates cage extends beyond cone (inner-ring) backface.  
 (7) Negative value indicates cage that does not extend beyond cone (inner-ring) front face.

Continued on next page.

# TAPERED ROLLER BEARINGS

## SINGLE-ROW • TYPE TS

### TYPE TS



Bearing Dimensions			Load Ratings							Part Number		
Bore d	O.D. D	Width T	Dynamic <sup>(1)</sup>		Factors <sup>(2)</sup>		Dynamic <sup>(3)</sup>		Factors <sup>(2)</sup>	Static	Inner	Outer
			C <sub>1</sub>	e	Y	C <sub>90</sub>	C <sub>a90</sub>	K	C <sub>0</sub>			
mm in.	mm in.	mm in.	N lbf			N lbf	N lbf			N lbf		
61.912 2.4375	110.000 4.3307	22.000 0.8661	98900 22200	0.40	1.49	25600 5760	17600 3970	1.45	125000 28100		392	394A
61.912 2.4375	112.712 4.4375	26.967 1.0617	98900 22200	0.40	1.49	25600 5760	17600 3970	1.45	125000 28100		392	3920
61.912 2.4375	123.825 4.8750	38.100 1.5000	191000 42900	0.35	1.73	49400 11100	29300 6590	1.69	248000 55700		554	552A
61.912 2.4375	127.000 5.0000	36.512 1.4375	229000 51500	0.50	1.20	59400 13400	51100 11500	1.16	256000 57600		HM813843	HM813810
61.912 2.4375	130.175 5.1250	36.512 1.4375	198000 44400	0.82	0.73	51200 11500	71900 16200	0.71	183000 41100		HM911249	HM911210
61.912 2.4375	136.525 5.3750	46.038 1.8125	319000 71700	0.47	1.27	82700 18600	67000 15100	1.24	405000 91000		H715334	H715311
61.912 2.4375	139.700 5.5000	46.038 1.8125	319000 71700	0.47	1.27	82700 18600	67000 15100	1.24	405000 91000		H715334	H715310
61.912 2.4375	146.050 5.7500	41.275 1.6250	273000 61300	0.78	0.77	70700 15900	94700 21300	0.75	256000 57500		H913842	H913810
61.912 2.4375	146.050 5.7500	41.275 1.6250	273000 61300	0.78	0.77	70700 15900	94700 21300	0.75	256000 57500		H913843	H913810
61.912 2.4375	152.400 6.0000	47.625 1.8750	285000 64200	0.66	0.91	74000 16600	83100 18700	0.89	306000 68700		9180	9121
61.912 2.4375	152.400 6.0000	47.625 1.8750	285000 64200	0.66	0.91	74000 16600	83100 18700	0.89	306000 68700		9181	9121
61.912 2.4375	158.750 6.2500	50.800 2.0000	285000 64200	0.66	0.91	74000 16600	83100 18700	0.89	306000 68700		9181	9120
61.912 2.4375	158.750 6.2500	50.800 2.0000	285000 64200	0.66	0.91	74000 16600	83100 18700	0.89	306000 68700		9180	9120
61.912 2.4375	158.750 6.2500	55.562 2.1875	285000 64200	0.66	0.91	74000 16600	83100 18700	0.89	306000 68700		9178	9120
61.976 2.4400	99.979 3.9362	23.812 0.9375	106000 23800	0.43	1.41	27500 6180	20000 4500	1.37	149000 33500		28990	28919
62.737 2.4700	100.000 3.9370	25.400 1.0000	106000 23800	0.43	1.41	27500 6180	20000 4500	1.37	149000 33500		28995	28921
62.737 2.4700	101.600 4.0000	25.400 1.0000	106000 23800	0.43	1.41	27500 6180	20000 4500	1.37	149000 33500		28995	28920

<sup>(1)</sup>Based on  $1 \times 10^6$  revolutions  $L_{10}$  life, for the ISO life-calculation method.

<sup>(2)</sup>Consult your Timken engineer for instructions on use or review the Timken Engineering Manual on [timken.com/catalogs](http://timken.com/catalogs).

<sup>(3)</sup>Based on  $90 \times 10^6$  revolutions  $L_{10}$  life, for The Timken Company life-calculation method.  $C_{90}$  and  $C_{a90}$  are radial and thrust values.

Bearing Dimensions											Geometry Factors			Bearing Weight
Width B	Width C	Eff. Ctr. a <sup>(4)</sup>	Shaft			Housing			Cage		G <sub>1</sub>	G <sub>2</sub>	C <sub>g</sub>	
			Max Shaft Fillet Radius R <sup>(5)</sup>	Backing Shoulder Dia. d <sub>a</sub>	Shoulder Dia. d <sub>b</sub>	Max Housing Fillet Radius r <sup>(5)</sup>	Backing Shoulder Dia. D <sub>a</sub>	Shoulder Dia. D <sub>b</sub>	A <sub>a</sub> <sup>(6)</sup>	A <sub>b</sub> <sup>(7)</sup>				
mm in.	mm in.	mm in.	mm in.	mm in.	mm in.	mm in.	mm in.	mm in.	mm in.	mm in.				kg lbs.
21.996 0.8660	18.824 0.7411	-0.8 -0.03	0.8 0.03	69.0 2.72	70.0 2.76	1.3 0.05	105.0 4.13	101.0 3.98	1.7 0.07	2.1 0.08	56.0	21.4	0.0984	0.86 1.91
21.996 0.8660	23.812 0.9375	-0.8 -0.03	0.8 0.03	69.0 2.72	70.0 2.76	3.3 0.13	106.0 4.17	99.0 3.90	1.7 0.07	2.1 0.08	56.0	21.4	0.0984	1.05 2.33
36.678 1.4440	30.162 1.1875	-9.4 -0.37	3.5 0.14	71.0 2.80	77.0 3.03	3.3 0.13	116.0 4.57	109.0 4.29	2.3 0.09	1.3 0.05	91.0	21.1	0.1108	2.02 4.46
36.512 1.4375	26.988 1.0625	-3.8 -0.15	3.5 0.14	78.0 3.07	85.0 3.35	3.3 0.13	121.0 4.76	111.0 4.37	4.0 0.15	1.3 0.06	91.7	22.9	0.1252	2.13 4.71
33.338 1.3125	23.812 0.9375	5.3 0.21	3.5 0.14	74.0 2.91	91.0 3.58	3.3 0.13	123.6 4.87	109.0 4.29	7.3 0.29	4.3 0.17	56.4	16.5	0.0842	2.03 4.48
46.038 1.8125	36.512 1.4375	-8.6 -0.34	3.5 0.14	81.0 3.19	87.0 3.43	3.3 0.13	132.0 5.20	118.0 4.65	4.1 0.16	2.0 0.08	147.1	33.5	0.0993	3.47 7.65
46.038 1.8125	36.512 1.4375	-8.6 -0.34	3.5 0.14	81.0 3.19	87.0 3.43	3.3 0.13	133.0 5.24	120.0 4.72	4.1 0.16	2.0 0.08	147.1	33.5	0.0993	3.65 8.05
39.688 1.5625	25.400 1.0000	4.3 0.17	3.5 0.14	82.4 3.24	90.0 3.54	3.3 0.13	138.0 5.43	124.0 4.88	8.2 0.32	3.6 0.14	78.5	17.3	0.0927	3.13 6.90
39.688 1.5625	25.400 1.0000	4.3 0.17	7.0 0.28	82.4 3.24	97.0 3.82	3.3 0.13	138.0 5.43	124.0 4.88	8.2 0.32	3.6 0.14	78.5	17.3	0.0927	3.11 6.87
46.038 1.8125	31.750 1.2500	-3.8 -0.15	3.5 0.14	81.3 3.20	90.0 3.54	3.3 0.13	145.0 5.71	130.0 5.12	8.1 0.31	4.1 0.16	87.6	13.7	0.0912	3.98 8.78
46.038 1.8125	31.750 1.2500	-3.8 -0.15	0.8 0.03	81.3 3.20	85.0 3.35	3.3 0.13	145.0 5.71	130.0 5.12	8.1 0.31	4.1 0.16	87.6	13.7	0.0912	3.99 8.80
46.038 1.8125	34.925 1.3750	-3.8 -0.15	0.8 0.03	81.3 3.20	85.0 3.35	3.3 0.13	146.0 5.75	131.0 5.16	8.1 0.31	4.1 0.16	87.6	13.7	0.0912	4.61 10.17
46.038 1.8125	34.925 1.3750	-3.8 -0.15	3.5 0.14	81.3 3.20	90.0 3.54	3.3 0.13	146.0 5.75	131.0 5.16	8.1 0.31	4.1 0.16	87.6	13.7	0.0912	4.60 10.14
52.388 2.0625	34.925 1.3750	-8.4 -0.33	3.5 0.14	81.3 3.20	90.0 3.54	3.3 0.13	146.0 5.75	131.0 5.16	12.8 0.50	2.5 0.10	87.6	13.7	0.0912	4.86 10.71
24.608 0.9688	19.050 0.7500	-1.8 -0.07	2.0 0.08	68.0 2.68	72.0 2.83	1.5 0.06	96.0 3.78	90.0 3.54	1.2 0.04	1.4 0.06	60.1	24.5	0.1032	0.70 1.56
25.400 1.0000	19.845 0.7813	-2.5 -0.10	3.5 0.14	69.0 2.72	75.0 2.95	3.3 0.13	96.0 3.78	89.0 3.50	2.0 0.07	1.4 0.06	60.1	24.5	0.1032	0.69 1.55
25.400 1.0000	19.845 0.7813	-2.5 -0.10	3.5 0.14	69.0 2.72	75.0 2.95	3.3 0.13	97.0 3.82	90.0 3.54	2.0 0.07	1.4 0.06	60.1	24.5	0.1032	0.73 1.64

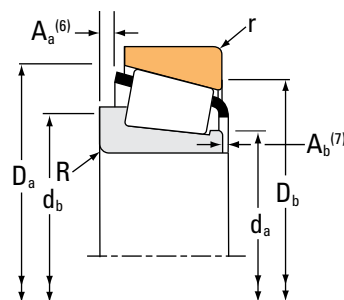
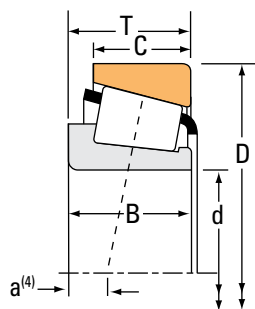
<sup>(4)</sup>Negative value indicates effective center inside cone (inner-ring) backface.  
<sup>(5)</sup>These maximum fillet radii will be cleared by the bearing corners.  
<sup>(6)</sup>Negative value indicates cage extends beyond cone (inner-ring) backface.  
<sup>(7)</sup>Negative value indicates cage that does not extend beyond cone (inner-ring) front face.

Continued on next page.

# TAPERED ROLLER BEARINGS

## SINGLE-ROW • TYPE TS

### TYPE TS



Bearing Dimensions			Load Ratings						Part Number				
Bore d	O.D. D	Width T	Dynamic <sup>(1)</sup>		Factors <sup>(2)</sup>		Dynamic <sup>(3)</sup>		Factors <sup>(2)</sup>		Static C <sub>0</sub>	Inner	Outer
			C <sub>1</sub>	e	Y	C <sub>90</sub>	C <sub>a90</sub>	K	N	N			
mm in.	mm in.	mm in.	N lbf			N lbf	N lbf		N lbf				
63.500 2.5000	92.075 3.6250	13.495 0.5313	38700 8700	0.41	1.48	10000 2260	6960 1560	1.44	53300 12000		LL510749	LL510710	
63.500 2.5000	94.458 3.7188	19.050 0.7500	67000 15100	0.42	1.41	17400 3910	12600 2840	1.38	108000 24300		L610549	L610510	
63.500 2.5000	104.775 4.1250	21.433 0.8438	115000 25800	0.39	1.55	29700 6680	19700 4440	1.51	120000 27000		39250	39412	
63.500 2.5000	107.158 4.2188	22.000 0.8661	115000 25800	0.39	1.55	29700 6680	19700 4440	1.51	120000 27000		39250	39422	
63.500 2.5000	107.950 4.2500	25.400 1.0000	131000 29400	0.46	1.31	33800 7610	26600 5970	1.27	161000 36300		29585	29520	
63.500 2.5000	107.950 4.2500	25.400 1.0000	131000 29400	0.46	1.31	33800 7610	26600 5970	1.27	161000 36300		29585	29522	
63.500 2.5000	107.950 4.2500	25.400 1.0000	131000 29400	0.46	1.31	33800 7610	26600 5970	1.27	161000 36300		29586	29520	
63.500 2.5000	107.950 4.2500	25.400 1.0000	131000 29400	0.46	1.31	33800 7610	26600 5970	1.27	161000 36300		29586	29522	
63.500 2.5000	110.000 4.3307	22.000 0.8661	98900 22200	0.40	1.49	25600 5760	17600 3970	1.45	125000 28100		395	394	
63.500 2.5000	110.000 4.3307	22.000 0.8661	98900 22200	0.40	1.49	25600 5760	17600 3970	1.45	125000 28100		395	394A	
63.500 2.5000	110.000 4.3307	22.000 0.8661	98900 22200	0.40	1.49	25600 5760	17600 3970	1.45	125000 28100		395	394AS	
63.500 2.5000	110.000 4.3307	22.000 0.8661	98900 22200	0.40	1.49	25600 5760	17600 3970	1.45	125000 28100		390A	394AS	
63.500 2.5000	110.000 4.3307	22.000 0.8661	98900 22200	0.40	1.49	25600 5760	17600 3970	1.45	125000 28100		390A	394A	
63.500 2.5000	110.000 4.3307	25.400 1.0000	131000 29400	0.46	1.31	33800 7610	26600 5970	1.27	161000 36300		29585	29521	
63.500 2.5000	110.000 4.3307	25.400 1.0000	131000 29400	0.46	1.31	33800 7610	26600 5970	1.27	161000 36300		29586	29521	
63.500 2.5000	110.000 4.3307	29.370 1.1563	139000 31200	0.40	1.49	36000 8090	24800 5570	1.45	191000 43000		3982X	3927AS	
63.500 2.5000	110.000 4.3307	30.162 1.1875	139000 31200	0.40	1.49	36000 8090	24800 5570	1.45	191000 43000		3982	3927X	

<sup>(1)</sup>Based on  $1 \times 10^6$  revolutions  $L_{10}$  life, for the ISO life-calculation method.

<sup>(2)</sup>Consult your Timken engineer for instructions on use or review the Timken Engineering Manual on [timken.com/catalogs](http://timken.com/catalogs).

<sup>(3)</sup>Based on  $90 \times 10^6$  revolutions  $L_{10}$  life, for The Timken Company life-calculation method.  $C_{90}$  and  $C_{a90}$  are radial and thrust values.

Bearing Dimensions											Geometry Factors			Bearing Weight
Width B	Width C	Eff. Ctr. a <sup>(4)</sup>	Shaft			Housing			Cage		G <sub>1</sub>	G <sub>2</sub>	C <sub>g</sub>	
			Max Shaft Fillet Radius R <sup>(5)</sup>	Backing Shoulder Dia. d <sub>a</sub>	Shoulder Dia. d <sub>b</sub>	Max Housing Fillet Radius r <sup>(5)</sup>	Backing Shoulder Dia. D <sub>a</sub>	Shoulder Dia. D <sub>b</sub>	A <sub>a</sub> <sup>(6)</sup>	A <sub>b</sub> <sup>(7)</sup>				
mm in.	mm in.	mm in.	mm in.	mm in.	mm in.	mm in.	mm in.	mm in.	mm in.	mm in.				kg lbs.
12.700 0.5000	9.525 0.3750	3.0 0.12	1.5 0.06	68.0 2.68	70.0 2.76	1.5 0.06	88.0 3.46	86.0 3.39	0.5 0.02	1.9 0.08	33.9	45.9	0.0827	0.26 0.58
19.050 0.7500	15.083 0.5938	0.5 0.02	1.5 0.06	69.0 2.72	71.0 2.80	1.5 0.06	91.0 3.58	86.0 3.39	0.9 0.03	1.5 0.06	56.7	50.3	0.1006	0.45 0.99
22.000 0.8661	15.875 0.6250	-1.5 -0.06	2.0 0.08	69.0 2.72	73.0 2.87	2.0 0.08	100.0 3.94	96.0 3.78	1.6 0.06	2.4 0.10	51.7	19.5	0.0947	0.68 1.50
22.000 0.8661	21.204 0.8348	-1.5 -0.06	2.0 0.08	69.0 2.72	73.0 2.87	2.3 0.09	102.0 4.02	97.0 3.82	1.6 0.06	2.4 0.10	51.7	19.5	0.0947	0.77 1.71
25.400 1.0000	19.050 0.7500	-0.8 -0.03	3.5 0.14	71.0 2.80	77.0 3.03	3.3 0.13	103.0 4.06	96.0 3.78	2.1 0.08	1.4 0.06	70.3	25.9	0.1112	0.91 2.01
25.400 1.0000	19.050 0.7500	-0.8 -0.03	3.5 0.14	71.0 2.80	77.0 3.03	0.8 0.03	103.0 4.06	98.0 3.86	2.1 0.08	1.4 0.06	70.3	25.9	0.1112	0.92 2.03
25.400 1.0000	19.050 0.7500	-0.8 -0.03	1.5 0.06	71.0 2.80	73.0 2.87	3.3 0.13	103.0 4.06	96.0 3.78	2.1 0.08	1.4 0.06	70.3	25.9	0.1112	0.92 2.02
25.400 1.0000	19.050 0.7500	-0.8 -0.03	1.5 0.06	71.0 2.80	73.0 2.87	0.8 0.03	103.0 4.06	98.0 3.86	2.1 0.08	1.4 0.06	70.3	25.9	0.1112	0.93 2.05
21.996 0.8660	22.000 0.8661	-0.8 -0.03	3.5 0.14	70.0 2.76	77.0 3.03	0.8 0.03	106.2 4.18	101.0 3.98	1.7 0.07	2.1 0.08	56.0	21.4	0.0984	0.85 1.88
21.996 0.8660	18.824 0.7411	-0.8 -0.03	3.5 0.14	70.0 2.76	77.0 3.03	1.3 0.05	105.0 4.13	101.0 3.98	1.7 0.07	2.1 0.08	56.0	21.4	0.0984	0.83 1.84
21.996 0.8660	18.824 0.7411	-0.8 -0.03	3.5 0.14	70.0 2.76	77.0 3.03	3.3 0.13	104.5 4.11	99.0 3.90	1.7 0.07	2.1 0.08	56.0	21.4	0.0984	0.82 1.81
21.996 0.8660	18.824 0.7411	-0.8 -0.03	1.5 0.06	70.0 2.76	73.0 2.87	3.3 0.13	104.5 4.11	99.0 3.90	1.6 0.06	2.3 0.09	56.0	21.4	0.0984	0.83 1.81
21.996 0.8660	18.824 0.7411	-0.8 -0.03	1.5 0.06	70.0 2.76	73.0 2.87	1.3 0.05	105.0 4.13	101.0 3.98	1.6 0.06	2.3 0.09	56.0	21.4	0.0984	0.84 1.84
25.400 1.0000	19.050 0.7500	-0.8 -0.03	3.5 0.14	71.0 2.80	77.0 3.03	1.3 0.05	104.0 4.09	99.0 3.90	2.1 0.08	1.4 0.06	70.3	25.9	0.1112	0.98 2.15
25.400 1.0000	19.050 0.7500	-0.8 -0.03	1.5 0.06	71.0 2.80	73.0 2.87	1.3 0.05	104.0 4.09	99.0 3.90	2.1 0.08	1.4 0.06	70.3	25.9	0.1112	0.99 2.17
30.048 1.1830	23.020 0.9063	-4.6 -0.18	7.0 0.28	71.0 2.80	84.0 3.31	0.5 0.02	105.0 4.13	101.0 3.94	2.2 0.08	1.2 0.05	75.2	21.3	0.1092	1.10 2.43
30.048 1.1830	23.812 0.9375	-4.6 -0.18	3.5 0.14	71.0 2.80	77.0 3.03	3.3 0.13	105.0 4.13	99.0 3.90	2.2 0.08	1.2 0.05	75.2	21.3	0.1092	1.13 2.50

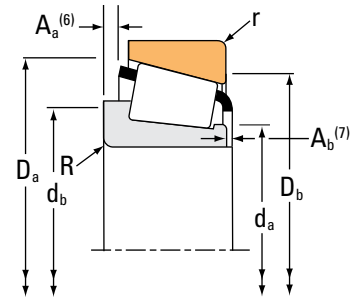
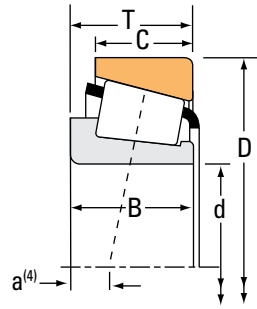
<sup>(4)</sup>Negative value indicates effective center inside cone (inner-ring) backface.  
<sup>(5)</sup>These maximum fillet radii will be cleared by the bearing corners.  
<sup>(6)</sup>Negative value indicates cage extends beyond cone (inner-ring) backface.  
<sup>(7)</sup>Negative value indicates cage that does not extend beyond cone (inner-ring) front face.

Continued on next page.

# TAPERED ROLLER BEARINGS

## SINGLE-ROW • TYPE TS

### TYPE TS



Bearing Dimensions			Load Ratings							Part Number			
Bore d	O.D. D	Width T	Dynamic <sup>(1)</sup>		Factors <sup>(2)</sup>		Dynamic <sup>(3)</sup>		Factors <sup>(2)</sup>		Static C <sub>0</sub>	Inner	Outer
			C <sub>1</sub>	e	Y	C <sub>90</sub>	C <sub>a90</sub>	K	N	N			
mm in.	mm in.	mm in.	N lbf			N lbf	N lbf		N lbf				
63.500 2.5000	110.058 4.3330	22.000 0.8661	115000 25800	0.39	1.55	29700 6680	19700 4440	1.51	120000 27000			39250	39433
63.500 2.5000	112.712 4.4375	26.967 1.0617	98900 22200	0.40	1.49	25600 5760	17600 3970	1.45	125000 28100			395	3920
63.500 2.5000	112.712 4.4375	26.967 1.0617	98900 22200	0.40	1.49	25600 5760	17600 3970	1.45	125000 28100			390A	3920
63.500 2.5000	112.712 4.4375	30.162 1.1875	139000 31200	0.40	1.49	36000 8090	24800 5570	1.45	191000 43000			3982	3925
63.500 2.5000	112.712 4.4375	30.162 1.1875	139000 31200	0.40	1.49	36000 8090	24800 5570	1.45	191000 43000			3982	3920
63.500 2.5000	112.712 4.4375	30.162 1.1875	167000 37500	0.34	1.77	43300 9730	25100 5650	1.72	224000 50300			39585	39520
63.500 2.5000	112.712 4.4375	30.162 1.1875	167000 37500	0.34	1.77	43300 9730	25100 5650	1.72	224000 50300			39585A	39520
63.500 2.5000	112.712 4.4375	33.338 1.3125	139000 31200	0.40	1.49	36000 8090	24800 5570	1.45	191000 43000			3982	3926
63.500 2.5000	117.475 4.6250	30.162 1.1875	138000 31100	0.44	1.38	35900 8060	26800 6020	1.34	197000 44300			33251	33462
63.500 2.5000	120.000 4.7244	29.002 1.1418	143000 32200	0.38	1.56	37200 8360	24500 5500	1.52	186000 41900			483	472A
63.500 2.5000	120.000 4.7244	29.002 1.1418	143000 32200	0.38	1.56	37200 8360	24500 5500	1.52	186000 41900			477	472A
63.500 2.5000	120.000 4.7244	29.794 1.1730	143000 32200	0.38	1.56	37200 8360	24500 5500	1.52	186000 41900			477	473
63.500 2.5000	120.000 4.7244	29.794 1.1730	143000 32200	0.38	1.56	37200 8360	24500 5500	1.52	186000 41900			483	472
63.500 2.5000	120.000 4.7244	29.794 1.1730	143000 32200	0.38	1.56	37200 8360	24500 5500	1.52	186000 41900			477	472
63.500 2.5000	122.238 4.8125	38.100 1.5000	267000 60000	0.34	1.78	69200 15600	40000 8990	1.73	279000 62700			HM212046	HM212010
63.500 2.5000	122.238 4.8125	38.100 1.5000	267000 60000	0.34	1.78	69200 15600	40000 8990	1.73	279000 62700			HM212047	HM212010
63.500 2.5000	122.238 4.8125	38.100 1.5000	267000 60000	0.34	1.78	69200 15600	40000 8990	1.73	279000 62700			HM212047	HM212011

<sup>(1)</sup>Based on  $1 \times 10^6$  revolutions  $L_{10}$  life, for the ISO life-calculation method.

<sup>(2)</sup>Consult your Timken engineer for instructions on use or review the Timken Engineering Manual on [timken.com/catalogs](http://timken.com/catalogs).

<sup>(3)</sup>Based on  $90 \times 10^6$  revolutions  $L_{10}$  life, for The Timken Company life-calculation method.  $C_{90}$  and  $C_{a90}$  are radial and thrust values.

Bearing Dimensions											Geometry Factors			Bearing Weight
Width B	Width C	Eff. Ctr. a <sup>(4)</sup>	Shaft			Housing			Cage		G <sub>1</sub>	G <sub>2</sub>	C <sub>g</sub>	
			Max Shaft Fillet Radius R <sup>(5)</sup>	Backing Shoulder Dia. d <sub>a</sub>	Backing Shoulder Dia. d <sub>b</sub>	Max Housing Fillet Radius r <sup>(5)</sup>	Backing Shoulder Dia. D <sub>a</sub>	Backing Shoulder Dia. D <sub>b</sub>	A <sub>a</sub> <sup>(6)</sup>	A <sub>b</sub> <sup>(7)</sup>				
mm in.	mm in.	mm in.	mm in.	mm in.	mm in.	mm in.	mm in.	mm in.	mm in.	mm in.				kg lbs.
22.000 0.8661	17.236 0.6786	-1.5 -0.06	2.0 0.08	69.0 2.72	73.0 2.87	2.3 0.09	103.0 4.06	98.0 3.86	1.6 0.06	2.4 0.10	51.7	19.5	0.0947	0.80 1.78
21.996 0.8660	23.812 0.9375	-0.8 -0.03	3.5 0.14	70.0 2.76	77.0 3.03	3.3 0.13	106.0 4.17	99.0 3.90	1.7 0.07	2.1 0.08	56.0	21.4	0.0984	1.02 2.26
21.996 0.8660	23.812 0.9375	-0.8 -0.03	1.5 0.06	70.0 2.76	73.0 2.87	3.3 0.13	106.0 4.17	99.0 3.90	1.6 0.06	2.3 0.09	56.0	21.4	0.0984	1.03 2.26
30.048 1.1830	23.812 0.9375	-4.6 -0.18	3.5 0.14	71.0 2.80	77.0 3.03	0.8 0.03	106.0 4.17	101.0 3.98	2.2 0.08	1.2 0.05	75.2	21.3	0.1092	1.24 2.73
30.048 1.1830	23.812 0.9375	-4.6 -0.18	3.5 0.14	71.0 2.80	77.0 3.03	3.3 0.13	106.0 4.17	99.0 3.90	2.2 0.08	1.2 0.05	75.2	21.3	0.1092	1.23 2.72
30.162 1.1875	23.812 0.9375	-6.6 -0.26	3.5 0.14	71.0 2.80	77.0 3.03	3.3 0.13	107.0 4.21	101.0 3.98	1.6 0.06	2.7 0.11	84.3	23.7	0.1074	1.23 2.72
30.162 1.1875	23.812 0.9375	-6.6 -0.26	0.8 0.03	71.0 2.80	72.0 2.83	3.3 0.13	107.0 4.21	101.0 3.98	1.6 0.06	2.7 0.11	84.3	23.7	0.1074	1.24 2.74
30.048 1.1830	26.988 1.0625	-4.6 -0.18	3.5 0.14	71.0 2.80	77.0 3.03	3.3 0.13	106.0 4.17	98.0 3.86	2.2 0.08	1.2 0.05	75.2	21.3	0.1092	1.31 2.90
30.162 1.1875	23.812 0.9375	-2.8 -0.11	0.8 0.03	72.0 2.83	73.0 2.87	3.3 0.13	112.0 4.41	104.0 4.09	2.2 0.08	1.1 0.05	84.2	25.9	0.1162	1.42 3.13
29.007 1.1420	23.444 0.9230	-4.1 -0.16	3.5 0.14	72.0 2.83	78.0 3.07	3.3 0.13	114.0 4.49	106.0 4.17	1.5 0.05	2.2 0.09	77.2	23.0	0.1083	1.43 3.15
29.007 1.1420	23.444 0.9230	-4.1 -0.16	0.8 0.03	72.0 2.83	73.0 2.87	3.3 0.13	114.0 4.49	106.0 4.17	1.5 0.05	2.2 0.09	77.2	23.0	0.1083	1.44 3.17
29.007 1.1420	29.000 1.1417	-4.1 -0.16	0.8 0.03	72.0 2.83	73.0 2.87	2.0 0.08	114.0 4.49	107.0 4.21	1.5 0.05	2.2 0.09	77.2	23.0	0.1083	1.52 3.35
29.007 1.1420	24.237 0.9542	-4.1 -0.16	3.5 0.14	72.0 2.83	78.0 3.07	2.0 0.08	114.0 4.49	107.0 4.21	1.5 0.05	2.2 0.09	77.2	23.0	0.1083	1.46 3.22
29.007 1.1420	24.237 0.9542	-4.1 -0.16	0.8 0.03	72.0 2.83	73.0 2.87	2.0 0.08	114.0 4.49	107.0 4.21	1.5 0.05	2.2 0.09	77.2	23.0	0.1083	1.47 3.24
38.354 1.5100	29.718 1.1700	-10.9 -0.43	3.5 0.14	73.0 2.87	80.0 3.15	1.5 0.06	116.0 4.57	110.0 4.33	2.2 0.08	3.1 0.12	92.2	18.1	0.0759	1.95 4.30
38.354 1.5100	29.718 1.1700	-10.9 -0.43	7.0 0.28	73.0 2.87	87.0 3.43	1.5 0.06	116.0 4.57	110.0 4.33	2.2 0.08	3.1 0.12	92.2	18.1	0.0759	1.94 4.27
38.354 1.5100	29.718 1.1700	-10.9 -0.43	7.0 0.28	73.0 2.87	87.0 3.43	3.3 0.13	116.0 4.57	108.0 4.25	2.2 0.08	3.1 0.12	92.2	18.1	0.0759	1.94 4.25

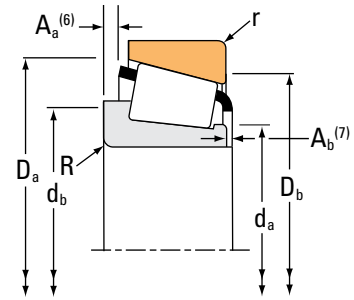
(4) Negative value indicates effective center inside cone (inner-ring) backface.  
 (5) These maximum fillet radii will be cleared by the bearing corners.  
 (6) Negative value indicates cage extends beyond cone (inner-ring) backface.  
 (7) Negative value indicates cage that does not extend beyond cone (inner-ring) front face.

Continued on next page.

# TAPERED ROLLER BEARINGS

## SINGLE-ROW • TYPE TS

### TYPE TS



Bearing Dimensions			Load Ratings							Part Number		
Bore d	O.D. D	Width T	Dynamic <sup>(1)</sup>		Factors <sup>(2)</sup>		Dynamic <sup>(3)</sup>		Factors <sup>(2)</sup>	Static	Inner	Outer
			C <sub>1</sub>	e	Y	C <sub>90</sub>	C <sub>a90</sub>	K	C <sub>0</sub>			
mm in.	mm in.	mm in.	N lbf			N lbf	N lbf			N lbf		
63.500 2.5000	122.238 4.8125	38.100 1.5000	267000 60000	0.34	1.78	69200 15600	40000 8990	1.73		279000 62700	HM212046	HM212011
63.500 2.5000	122.238 4.8125	43.658 1.7188	237000 53200	0.36	1.67	61300 13800	37600 8460	1.63		327000 73500	5564	5535
63.500 2.5000	122.238 4.8125	43.658 1.7188	280000 63000	0.36	1.67	72700 16300	44600 10000	1.63		327000 73500	5584	5535
63.500 2.5000	123.825 4.8750	30.162 1.1875	143000 32200	0.38	1.56	37200 8360	24500 5500	1.52		186000 41900	483	472X
63.500 2.5000	123.825 4.8750	38.100 1.5000	226000 50800	0.35	1.73	58600 13200	34700 7810	1.69		248000 55700	559	552
63.500 2.5000	123.825 4.8750	38.100 1.5000	226000 50800	0.35	1.73	58600 13200	34700 7810	1.69		248000 55700	559	552A
63.500 2.5000	127.000 5.0000	36.512 1.4375	196000 44100	0.36	1.65	50900 11400	31700 7130	1.61		262000 58900	565	563
63.500 2.5000	127.000 5.0000	36.512 1.4375	229000 51500	0.50	1.20	59400 13400	51100 11500	1.16		256000 57600	HM813842	HM813811
63.500 2.5000	127.000 5.0000	36.512 1.4375	229000 51500	0.50	1.20	59400 13400	51100 11500	1.16		256000 57600	HM813842	HM813810
63.500 2.5000	127.000 5.0000	36.512 1.4375	229000 51500	0.50	1.20	59400 13400	51100 11500	1.16		256000 57600	HM813842A	HM813810
63.500 2.5000	130.000 5.1181	36.937 1.4542	196000 44100	0.36	1.65	50900 11400	31700 7130	1.61		262000 58900	565-S	562X
63.500 2.5000	130.000 5.1181	36.937 1.4542	196000 44100	0.36	1.65	50900 11400	31700 7130	1.61		262000 58900	565	562X
63.500 2.5000	130.000 5.1181	41.275 1.6250	276000 62100	0.36	1.66	71600 16100	44400 9980	1.61		298000 67000	639	633X
63.500 2.5000	130.175 5.1250	41.275 1.6250	276000 62100	0.36	1.66	71600 16100	44400 9980	1.61		298000 67000	639	633
63.500 2.5000	135.755 5.3447	53.975 2.1250	321000 72300	0.32	1.85	83300 18700	46300 10400	1.80		404000 90900	6382	6320
63.500 2.5000	136.525 5.3750	36.512 1.4375	203000 45600	0.87	0.69	52600 11800	77900 17500	0.67		193000 43400	78250	78537
63.500 2.5000	136.525 5.3750	36.512 1.4375	237000 53200	0.87	0.69	61300 13800	90900 20400	0.67		234000 52600	78248C	78537

<sup>(1)</sup>Based on 1 x 10<sup>6</sup> revolutions L<sub>10</sub> life, for the ISO life-calculation method.

<sup>(2)</sup>Consult your Timken engineer for instructions on use or review the Timken Engineering Manual on timken.com/catalogs.

<sup>(3)</sup>Based on 90 x 10<sup>6</sup> revolutions L<sub>10</sub> life, for The Timken Company life-calculation method. C<sub>90</sub> and C<sub>a90</sub> are radial and thrust values.



Bearing Dimensions											Geometry Factors			Bearing Weight
Width B	Width C	Eff. Ctr. a <sup>(4)</sup>	Shaft			Housing			Cage		G <sub>1</sub>	G <sub>2</sub>	C <sub>g</sub>	
			Max Shaft Fillet Radius R <sup>(5)</sup>	Backing Shoulder Dia. d <sub>a</sub>	Shoulder Dia. d <sub>b</sub>	Max Housing Fillet Radius r <sup>(5)</sup>	Backing Shoulder Dia. D <sub>a</sub>	Shoulder Dia. D <sub>b</sub>	A <sub>a</sub> <sup>(6)</sup>	A <sub>b</sub> <sup>(7)</sup>				
mm in.	mm in.	mm in.	mm in.	mm in.	mm in.	mm in.	mm in.	mm in.	mm in.	mm in.				kg lbs.
<b>38.354</b> 1.5100	<b>29.718</b> 1.1700	<b>-10.9</b> -0.43	<b>3.5</b> 0.14	<b>73.0</b> 2.87	<b>80.0</b> 3.15	<b>3.3</b> 0.13	<b>116.0</b> 4.57	<b>108.0</b> 4.25	<b>2.2</b> 0.08	<b>3.1</b> 0.12	92.2	18.1	0.0759	<b>1.95</b> 4.28
<b>43.764</b> 1.7230	<b>36.512</b> 1.4375	<b>-12.2</b> -0.48	<b>5.0</b> 0.20	<b>75.0</b> 2.95	<b>84.0</b> 3.31	<b>3.3</b> 0.13	<b>116.0</b> 4.57	<b>106.0</b> 4.17	<b>2.5</b> 0.09	<b>1.3</b> 0.05	110.4	24.2	0.0825	<b>2.27</b> 5.02
<b>43.764</b> 1.7230	<b>36.512</b> 1.4375	<b>-12.2</b> -0.48	<b>3.5</b> 0.14	<b>75.0</b> 2.95	<b>81.0</b> 3.19	<b>3.3</b> 0.13	<b>116.0</b> 4.57	<b>106.0</b> 4.17	<b>2.5</b> 0.09	<b>1.3</b> 0.05	110.4	24.2	0.0825	<b>2.28</b> 5.04
<b>29.007</b> 1.1420	<b>24.605</b> 0.9687	<b>-4.1</b> -0.16	<b>3.5</b> 0.14	<b>72.0</b> 2.83	<b>78.0</b> 3.07	<b>3.3</b> 0.13	<b>115.0</b> 4.53	<b>109.0</b> 4.29	<b>1.5</b> 0.05	<b>2.2</b> 0.09	77.2	23.0	0.1083	<b>1.60</b> 3.52
<b>36.678</b> 1.4440	<b>33.338</b> 1.3125	<b>-9.4</b> -0.37	<b>3.5</b> 0.14	<b>75.0</b> 2.95	<b>81.0</b> 3.19	<b>3.3</b> 0.13	<b>116.0</b> 4.57	<b>109.0</b> 4.29	<b>2.3</b> 0.09	<b>1.3</b> 0.05	91.0	21.1	0.1108	<b>2.03</b> 4.47
<b>36.678</b> 1.4440	<b>30.162</b> 1.1875	<b>-9.4</b> -0.37	<b>3.5</b> 0.14	<b>75.0</b> 2.95	<b>81.0</b> 3.19	<b>3.3</b> 0.13	<b>116.0</b> 4.57	<b>109.0</b> 4.29	<b>2.3</b> 0.09	<b>1.3</b> 0.05	91.0	21.1	0.1108	<b>1.98</b> 4.37
<b>36.170</b> 1.4240	<b>28.575</b> 1.1250	<b>-8.1</b> -0.32	<b>3.5</b> 0.14	<b>73.0</b> 2.87	<b>80.0</b> 3.15	<b>3.3</b> 0.13	<b>120.0</b> 4.72	<b>112.0</b> 4.41	<b>3.2</b> 0.12	<b>1.8</b> 0.08	101.3	24.0	0.1167	<b>2.09</b> 4.62
<b>36.512</b> 1.4375	<b>26.988</b> 1.0625	<b>-3.8</b> -0.15	<b>3.5</b> 0.14	<b>78.0</b> 3.07	<b>84.0</b> 3.31	<b>1.5</b> 0.06	<b>121.0</b> 4.76	<b>113.0</b> 4.45	<b>4.0</b> 0.15	<b>1.3</b> 0.06	91.7	22.9	0.1252	<b>2.09</b> 4.61
<b>36.512</b> 1.4375	<b>26.988</b> 1.0625	<b>-3.8</b> -0.15	<b>3.5</b> 0.14	<b>78.0</b> 3.07	<b>84.0</b> 3.31	<b>3.3</b> 0.13	<b>121.0</b> 4.76	<b>111.0</b> 4.37	<b>4.0</b> 0.15	<b>1.3</b> 0.06	91.7	22.9	0.1252	<b>2.09</b> 4.61
<b>36.512</b> 1.4375	<b>26.988</b> 1.0625	<b>-3.8</b> -0.15	<b>0.8</b> 0.03	<b>78.0</b> 3.07	<b>78.0</b> 3.07	<b>3.3</b> 0.13	<b>121.0</b> 4.76	<b>111.0</b> 4.37	<b>4.0</b> 0.15	<b>1.3</b> 0.06	91.7	22.9	0.1252	<b>2.09</b> 4.62
<b>36.170</b> 1.4240	<b>29.000</b> 1.1417	<b>-8.1</b> -0.32	<b>6.4</b> 0.25	<b>73.0</b> 2.87	<b>85.0</b> 3.35	<b>3.0</b> 0.12	<b>121.0</b> 4.76	<b>114.0</b> 4.49	<b>3.2</b> 0.12	<b>1.8</b> 0.08	101.3	24.0	0.1167	<b>2.21</b> 4.88
<b>36.170</b> 1.4240	<b>29.000</b> 1.1417	<b>-8.1</b> -0.32	<b>3.5</b> 0.14	<b>73.0</b> 2.87	<b>80.0</b> 3.15	<b>3.0</b> 0.12	<b>121.0</b> 4.76	<b>114.0</b> 4.49	<b>3.2</b> 0.12	<b>1.8</b> 0.08	101.3	24.0	0.1167	<b>2.24</b> 4.93
<b>41.275</b> 1.6250	<b>31.750</b> 1.2500	<b>-11.2</b> -0.44	<b>3.5</b> 0.14	<b>74.0</b> 2.91	<b>81.0</b> 3.19	<b>3.0</b> 0.12	<b>123.0</b> 4.84	<b>117.0</b> 4.61	<b>4.1</b> 0.16	<b>2.0</b> 0.08	106.4	21.0	0.0814	<b>2.48</b> 5.46
<b>41.275</b> 1.6250	<b>31.750</b> 1.2500	<b>-11.2</b> -0.44	<b>3.5</b> 0.14	<b>74.0</b> 2.91	<b>81.0</b> 3.19	<b>3.3</b> 0.13	<b>124.0</b> 4.88	<b>116.0</b> 4.57	<b>4.1</b> 0.16	<b>2.0</b> 0.08	106.4	21.0	0.0814	<b>2.49</b> 5.47
<b>56.007</b> 2.2050	<b>44.450</b> 1.7500	<b>-19.3</b> -0.76	<b>4.3</b> 0.17	<b>77.0</b> 3.03	<b>84.0</b> 3.31	<b>3.3</b> 0.13	<b>126.0</b> 4.96	<b>117.0</b> 4.61	<b>4.0</b> 0.15	<b>0.5</b> 0.02	123.5	22.4	0.0827	<b>3.69</b> 8.15
<b>33.236</b> 1.3085	<b>23.520</b> 0.9260	<b>7.9</b> 0.31	<b>2.3</b> 0.09	<b>79.0</b> 3.10	<b>85.0</b> 3.35	<b>3.3</b> 0.13	<b>130.0</b> 5.12	<b>115.0</b> 4.53	<b>6.9</b> 0.27	<b>4.2</b> 0.17	62.6	19.1	0.0884	<b>2.28</b> 5.02
<b>33.236</b> 1.3085	<b>23.520</b> 0.9260	<b>8.4</b> 0.33	<b>0.8</b> 0.03	<b>77.0</b> 3.03	<b>92.0</b> 3.62	<b>3.3</b> 0.13	<b>130.0</b> 5.12	<b>115.0</b> 4.53	<b>6.3</b> 0.25	<b>4.9</b> 0.20	71.3	17.6	0.0926	<b>2.38</b> 5.24

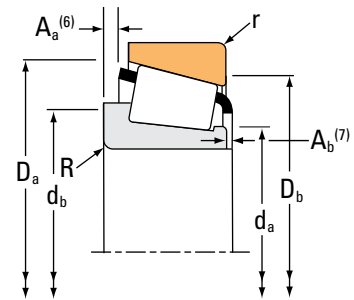
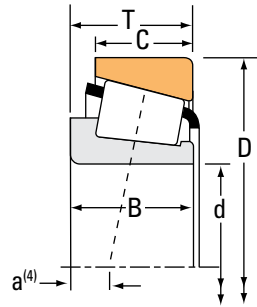
<sup>(4)</sup>Negative value indicates effective center inside cone (inner-ring) backface.  
<sup>(5)</sup>These maximum fillet radii will be cleared by the bearing corners.  
<sup>(6)</sup>Negative value indicates cage extends beyond cone (inner-ring) backface.  
<sup>(7)</sup>Negative value indicates cage that does not extend beyond cone (inner-ring) front face.

Continued on next page.

# TAPERED ROLLER BEARINGS

## SINGLE-ROW • TYPE TS

### TYPE TS



Bearing Dimensions			Load Ratings							Part Number			
Bore d	O.D. D	Width T	Dynamic <sup>(1)</sup>		Factors <sup>(2)</sup>		Dynamic <sup>(3)</sup>		Factors <sup>(2)</sup>		Static C <sub>0</sub>	Inner	Outer
			C <sub>1</sub>	e	Y	C <sub>90</sub>	C <sub>a90</sub>	K	N	N			
mm in.	mm in.	mm in.	N lbf			N lbf	N lbf		N lbf				
63.500 2.5000	136.525 5.3750	41.275 1.6250	276000 62100	0.36	1.66	71600 16100	44400 9980	1.61	298000 67000			639	632
63.500 2.5000	136.525 5.3750	41.275 1.6250	323000 72600	0.36	1.67	83700 18800	51600 11600	1.62	335000 75400			H414235	H414210
63.500 2.5000	136.525 5.3750	41.275 1.6250	272000 61200	0.36	1.67	70600 15900	43500 9790	1.62	335000 75400			H414236	H414210
63.500 2.5000	136.525 5.3750	46.038 1.8125	319000 71700	0.47	1.27	82700 18600	67000 15100	1.24	405000 91000			H715336	H715311
63.500 2.5000	139.700 5.5000	46.038 1.8125	319000 71700	0.47	1.27	82700 18600	67000 15100	1.24	405000 91000			H715336	H715310
63.500 2.5000	140.030 5.5130	36.512 1.4375	203000 45600	0.87	0.69	52600 11800	77900 17500	0.67	193000 43400			78250	78551
63.500 2.5000	149.225 5.8750	53.975 2.1250	411000 92400	0.36	1.66	107000 24000	66000 14800	1.61	463000 104000			6475	6420
63.500 2.5000	150.089 5.9090	44.450 1.7500	377000 84700	0.33	1.84	97600 21900	54400 12200	1.80	417000 93800			745-S	742
63.500 2.5000	177.800 7.0000	56.642 2.2300	451000 101000	0.80	0.75	117000 26300	160000 35900	0.73	413000 92900			HH914447	HH914412
64.960 2.5575	149.225 5.8750	41.275 1.6250	247000 55500	0.41	1.47	64000 14400	44800 10100	1.43	335000 75300			656	652A
64.960 2.5575	149.225 5.8750	53.975 2.1250	411000 92400	0.36	1.66	107000 24000	66000 14800	1.61	463000 104000			6464	6420
64.963 2.5576	127.000 5.0000	36.512 1.4375	196000 44100	0.36	1.65	50900 11400	31700 7130	1.61	262000 58900			569	563
64.987 2.5586	107.950 4.2500	25.400 1.0000	110000 24800	0.46	1.31	28600 6420	22400 5040	1.27	161000 36300			29588	29520
64.987 2.5586	112.712 4.4375	30.162 1.1875	167000 37500	0.34	1.77	43300 9730	25100 5650	1.72	224000 50300			39586	39520
64.987 2.5586	119.985 4.7238	32.750 1.2894	167000 37500	0.34	1.77	43300 9730	25100 5650	1.72	224000 50300			39586	39528
64.987 2.5586	140.030 5.5130	36.512 1.4375	203000 45600	0.87	0.69	52600 11800	77900 17500	0.67	193000 43400			78255X	78551
64.987 2.5586	144.983 5.7080	36.000 1.4173	203000 45600	0.87	0.69	52600 11800	77900 17500	0.67	193000 43400			78255X	78571

<sup>(1)</sup>Based on 1 x 10<sup>6</sup> revolutions L<sub>10</sub> life, for the ISO life-calculation method.

<sup>(2)</sup>Consult your Timken engineer for instructions on use or review the Timken Engineering Manual on timken.com/catalogs.

<sup>(3)</sup>Based on 90 x 10<sup>6</sup> revolutions L<sub>10</sub> life, for The Timken Company life-calculation method. C<sub>90</sub> and C<sub>a90</sub> are radial and thrust values.

Bearing Dimensions											Geometry Factors			Bearing Weight
Width B	Width C	Eff. Ctr. a <sup>(4)</sup>	Shaft			Housing			Cage		G <sub>1</sub>	G <sub>2</sub>	C <sub>g</sub>	
			Max Shaft Fillet Radius R <sup>(5)</sup>	Backing Shoulder Dia. d <sub>a</sub>	Backing Shoulder Dia. d <sub>b</sub>	Max Housing Fillet Radius r <sup>(5)</sup>	Backing Shoulder Dia. D <sub>a</sub>	Backing Shoulder Dia. D <sub>b</sub>	A <sub>a</sub> <sup>(6)</sup>	A <sub>b</sub> <sup>(7)</sup>				
mm in.	mm in.	mm in.	mm in.	mm in.	mm in.	mm in.	mm in.	mm in.	mm in.	mm in.				kg lbs.
41.275 1.6250	31.750 1.2500	-11.2 -0.44	3.5 0.14	74.0 2.91	81.0 3.19	3.3 0.13	125.0 4.92	118.0 4.65	4.1 0.16	2.0 0.08	106.4	21.0	0.0814	2.83 6.23
41.275 1.6250	31.750 1.2500	-10.9 -0.43	3.5 0.14	78.0 3.07	82.0 3.23	3.3 0.13	129.0 5.08	121.0 4.76	3.7 0.14	3.1 0.12	112.8	22.9	0.0827	2.82 6.22
41.275 1.6250	31.750 1.2500	-10.9 -0.43	7.0 0.28	78.0 3.07	89.0 3.50	3.3 0.13	129.0 5.08	121.0 4.76	3.7 0.14	3.1 0.12	112.8	22.9	0.0827	2.78 6.15
46.038 1.8125	36.512 1.4375	-8.6 -0.34	3.5 0.14	82.0 3.23	88.0 3.46	3.3 0.13	132.0 5.20	118.0 4.65	4.1 0.16	2.0 0.08	147.1	33.5	0.0993	3.41 7.52
46.038 1.8125	36.512 1.4375	-8.6 -0.34	3.5 0.14	82.0 3.23	88.0 3.46	3.3 0.13	133.0 5.24	120.0 4.72	4.1 0.16	2.0 0.08	147.1	33.5	0.0993	3.59 7.93
33.236 1.3085	23.520 0.9260	7.9 0.31	2.3 0.09	79.0 3.10	85.0 3.35	2.3 0.09	132.0 5.20	117.0 4.61	6.9 0.27	4.2 0.17	62.6	19.1	0.0884	2.42 5.34
54.229 2.1350	44.450 1.7500	-15.0 -0.59	3.5 0.14	80.0 3.15	86.0 3.39	3.3 0.13	140.0 5.51	129.0 5.08	2.7 0.10	0.7 0.03	158.3	29.1	0.0931	4.84 10.67
46.672 1.8375	36.512 1.4375	-11.9 -0.47	3.5 0.14	77.0 3.03	84.0 3.31	3.3 0.13	142.0 5.59	134.0 5.28	1.8 0.07	1.3 0.05	159.6	26.3	0.0898	4.17 9.18
53.975 2.1250	37.308 1.4688	-0.3 -0.01	3.5 0.14	85.3 3.36	105.0 4.13	3.3 0.13	165.0 6.50	146.0 5.75	9.8 0.38	4.7 0.19	111.4	17.8	0.1044	6.79 14.97
41.275 1.6250	31.750 1.2500	-7.9 -0.31	3.5 0.14	78.0 3.07	85.0 3.35	3.3 0.13	141.0 5.55	132.0 5.20	4.5 0.17	2.1 0.08	136.6	27.3	0.0919	3.58 7.89
54.229 2.1350	44.450 1.7500	-15.0 -0.59	3.5 0.14	81.0 3.19	87.0 3.43	3.3 0.13	140.0 5.51	129.0 5.08	2.7 0.10	0.7 0.03	158.3	29.1	0.0931	4.77 10.53
36.170 1.4240	28.575 1.1250	-8.1 -0.32	3.5 0.14	74.0 2.91	81.0 3.19	3.3 0.13	120.0 4.72	112.0 4.41	3.2 0.12	1.8 0.08	101.3	24.0	0.1167	2.04 4.53
25.400 1.0000	19.050 0.7500	-0.8 -0.03	3.5 0.14	72.0 2.83	78.0 3.07	3.3 0.13	103.0 4.06	96.0 3.78	2.1 0.08	1.4 0.06	70.3	25.9	0.1112	0.88 1.94
30.924 1.2175	23.812 0.9375	-6.6 -0.26	2.3 0.09	72.0 2.83	76.0 2.99	3.3 0.13	107.0 4.21	101.0 3.98	1.6 0.06	1.9 0.08	84.3	23.7	0.1074	1.21 2.67
30.924 1.2175	26.950 1.0610	-6.6 -0.26	2.3 0.09	72.0 2.83	76.0 2.99	0.8 0.03	110.0 4.33	107.0 4.21	1.6 0.06	1.9 0.08	84.3	23.7	0.1074	1.55 3.43
32.923 1.2962	23.520 0.9260	7.9 0.31	3.5 0.14	79.0 3.11	89.0 3.50	2.3 0.09	132.0 5.20	117.0 4.61	6.9 0.27	4.5 0.18	62.6	19.1	0.0884	2.37 5.23
32.923 1.2962	23.007 0.9058	7.9 0.31	3.5 0.14	79.0 3.11	89.0 3.50	3.5 0.14	132.0 5.20	118.0 4.65	6.9 0.27	4.5 0.18	62.6	19.1	0.0884	2.52 5.56

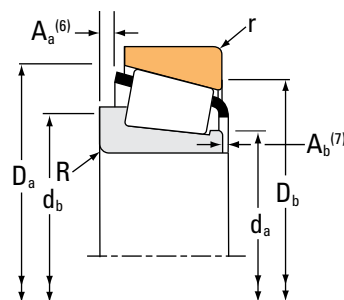
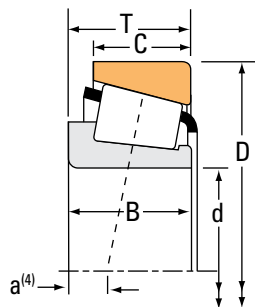
<sup>(4)</sup>Negative value indicates effective center inside cone (inner-ring) backface.  
<sup>(5)</sup>These maximum fillet radii will be cleared by the bearing corners.  
<sup>(6)</sup>Negative value indicates cage extends beyond cone (inner-ring) backface.  
<sup>(7)</sup>Negative value indicates cage that does not extend beyond cone (inner-ring) front face.

Continued on next page.

# TAPERED ROLLER BEARINGS

## SINGLE-ROW • TYPE TS

### TYPE TS



Bearing Dimensions			Load Ratings							Part Number		
Bore d	O.D. D	Width T	Dynamic <sup>(1)</sup>		Factors <sup>(2)</sup>		Dynamic <sup>(3)</sup>		Factors <sup>(2)</sup>	Static	Inner	Outer
			C <sub>1</sub>	e	Y	C <sub>90</sub>	C <sub>a90</sub>	K	C <sub>0</sub>			
mm in.	mm in.	mm in.	N lbf			N lbf	N lbf			N lbf		
65.000 2.5591	105.000 4.1339	24.000 0.9449	108000 24300	0.45	1.32	28000 6310	21800 4900	1.29		139000 31300	JLM710949C	JLM710910
65.000 2.5591	110.000 4.3307	28.000 1.1024	141000 31700	0.40	1.49	36600 8220	25200 5660	1.45		195000 43900	JM511946	JM511910
65.000 2.5591	112.712 4.4375	22.225 0.8750	91600 20600	0.40	1.49	23700 5340	16300 3670	1.45		125000 28100	399	393A
65.000 2.5591	112.712 4.4375	29.020 1.1425	167000 37600	0.40	1.49	43300 9740	29800 6700	1.45		195000 43900	JM511946	3920
65.000 2.5591	112.712 4.4375	29.020 1.1425	167000 37600	0.40	1.49	43300 9740	29800 6700	1.45		195000 43900	JM511945	3920
65.000 2.5591	120.000 4.7244	29.002 1.1418	143000 32200	0.38	1.56	37200 8360	24500 5500	1.52		186000 41900	478	472A
65.000 2.5591	120.000 4.7244	29.794 1.1730	143000 32200	0.38	1.56	37200 8360	24500 5500	1.52		186000 41900	478	473
65.000 2.5591	120.000 4.7244	29.794 1.1730	143000 32200	0.38	1.56	37200 8360	24500 5500	1.52		186000 41900	478	472
65.000 2.5591	120.000 4.7244	39.000 1.5354	223000 50100	0.34	1.78	57800 13000	33400 7500	1.73		283000 63600	JH211749	JH211710
65.000 2.5591	120.000 4.7244	39.000 1.5354	223000 50100	0.34	1.78	57800 13000	33400 7500	1.73		283000 63600	JH211749A	JH211710
65.000 2.5591	123.825 4.8750	30.162 1.1875	143000 32200	0.38	1.56	37200 8360	24500 5500	1.52		186000 41900	478	472X
65.000 2.5591	140.000 5.5118	53.975 2.1250	321000 72300	0.32	1.85	83300 18700	46300 10400	1.80		404000 90900	J6392	J6327
65.087 2.5625	135.755 5.3447	53.975 2.1250	381000 85600	0.32	1.85	98800 22200	54900 12300	1.80		404000 90900	6379	6320
65.087 2.5625	136.525 5.3750	46.038 1.8125	319000 71700	0.47	1.27	82700 18600	67000 15100	1.24		405000 91000	H715340	H715311
65.087 2.5625	139.700 5.5000	46.038 1.8125	319000 71700	0.47	1.27	82700 18600	67000 15100	1.24		405000 91000	H715340	H715310
65.883 2.5938	122.238 4.8125	43.655 1.7187	280000 63000	0.36	1.67	72700 16300	44600 10000	1.63		327000 73500	5595	5535
66.675 2.6250	103.213 4.0635	17.247 0.6790	82900 18600	0.49	1.23	21500 4830	17900 4030	1.20		89100 20000	L812147	L812111

<sup>(1)</sup>Based on 1 x 10<sup>6</sup> revolutions L<sub>10</sub> life, for the ISO life-calculation method.

<sup>(2)</sup>Consult your Timken engineer for instructions on use or review the Timken Engineering Manual on timken.com/catalogs.

<sup>(3)</sup>Based on 90 x 10<sup>6</sup> revolutions L<sub>10</sub> life, for The Timken Company life-calculation method. C<sub>90</sub> and C<sub>a90</sub> are radial and thrust values.

Bearing Dimensions											Geometry Factors			Bearing Weight
Width B	Width C	Eff. Ctr. a <sup>(4)</sup>	Shaft			Housing			Cage		G <sub>1</sub>	G <sub>2</sub>	C <sub>g</sub>	
			Max Shaft Fillet Radius R <sup>(5)</sup>	Backing Shoulder Dia. d <sub>a</sub>	mm d <sub>b</sub>	Max Housing Fillet Radius r <sup>(5)</sup>	Backing Shoulder Dia. D <sub>a</sub>	mm D <sub>b</sub>	A <sub>a</sub> <sup>(6)</sup>	A <sub>b</sub> <sup>(7)</sup>				
mm in.	mm in.	mm in.	mm in.	mm in.	mm in.	mm in.	mm in.	mm in.	mm in.	mm in.				kg lbs.
23.000 0.9055	18.500 0.7283	-0.3 -0.01	3.0 0.12	72.0 2.83	78.0 3.07	1.0 0.04	100.5 3.96	96.0 3.78	1.5 0.06	3.0 0.12	55.5	24.5	0.1023	0.76 1.66
28.000 1.1024	22.500 0.8858	-3.3 -0.13	3.0 0.12	72.0 2.83	78.0 3.07	2.5 0.10	105.0 4.13	99.0 3.90	1.1 0.04	2.0 0.08	76.3	23.6	0.1098	1.06 2.34
21.996 0.8660	15.875 0.6250	-0.8 -0.03	2.0 0.08	71.0 2.80	75.0 2.95	3.3 0.13	105.0 4.13	100.0 3.94	1.6 0.06	2.3 0.09	56.0	21.4	0.0984	0.84 1.85
28.000 1.1024	23.812 0.9375	-3.3 -0.13	3.0 0.12	72.0 2.83	78.0 3.07	3.3 0.13	106.0 4.17	99.0 3.90	1.1 0.04	2.0 0.08	76.3	23.6	0.1098	1.17 2.58
30.000 1.1811	23.812 0.9375	-3.3 -0.13	3.0 0.12	74.0 2.91	80.0 3.15	3.3 0.13	106.0 4.17	99.0 3.90	1.1 0.04	0.1 0.00	76.3	23.6	0.1098	1.19 2.63
29.007 1.1420	23.444 0.9230	-4.1 -0.16	2.3 0.09	73.0 2.87	77.0 3.03	3.3 0.13	114.0 4.49	106.0 4.17	1.5 0.05	2.2 0.09	77.2	23.0	0.1083	1.40 3.08
29.007 1.1420	29.000 1.1417	-4.1 -0.16	2.3 0.09	73.0 2.87	77.0 3.03	2.0 0.08	114.0 4.49	107.0 4.21	1.5 0.05	2.2 0.09	77.2	23.0	0.1083	1.48 3.27
29.007 1.1420	24.237 0.9542	-4.1 -0.16	2.3 0.09	73.0 2.87	77.0 3.03	2.0 0.08	114.0 4.49	107.0 4.21	1.5 0.05	2.2 0.09	77.2	23.0	0.1083	1.43 3.15
38.500 1.5157	32.000 1.2598	-10.8 -0.42	3.0 0.12	74.0 2.91	80.0 3.15	2.5 0.10	114.0 4.49	107.0 4.21	1.1 0.04	3.4 0.14	94.0	22.5	0.0764	1.87 4.12
38.500 1.5157	32.000 1.2598	-10.8 -0.42	7.0 0.28	74.0 2.91	88.0 3.46	2.5 0.10	114.0 4.49	107.0 4.21	1.1 0.04	3.4 0.14	94.0	22.5	0.0764	1.84 4.04
29.007 1.1420	24.605 0.9687	-4.1 -0.16	2.3 0.09	73.0 2.87	77.0 3.03	3.3 0.13	115.0 4.53	109.0 4.29	1.5 0.05	2.2 0.09	77.2	23.0	0.1083	1.57 3.46
56.000 2.2050	44.450 1.7500	-19.3 -0.76	3.0 0.12	77.0 3.04	83.0 3.27	3.3 0.13	136.0 5.35	119.0 4.69	4.0 0.15	0.5 0.02	123.5	22.4	0.0827	3.95 8.73
56.007 2.2050	44.450 1.7500	-19.3 -0.76	3.5 0.14	77.0 3.04	84.0 3.31	3.3 0.13	126.0 4.96	117.0 4.61	4.0 0.15	0.5 0.02	123.5	22.4	0.0827	3.63 8.01
46.038 1.8125	36.512 1.4375	-8.6 -0.34	3.5 0.14	83.0 3.27	89.0 3.50	3.3 0.13	132.0 5.20	118.0 4.65	4.1 0.16	2.0 0.08	147.1	33.5	0.0993	3.36 7.40
46.038 1.8125	36.512 1.4375	-8.6 -0.34	3.5 0.14	83.0 3.27	89.0 3.50	3.3 0.13	133.0 5.24	120.0 4.72	4.1 0.16	2.0 0.08	147.1	33.5	0.0993	3.54 7.80
43.764 1.7230	36.512 1.4375	-12.2 -0.48	3.5 0.14	77.0 3.03	83.0 3.27	3.3 0.13	116.0 4.57	106.0 4.17	2.5 0.09	1.3 0.05	110.4	24.2	0.0825	2.20 4.86
17.247 0.6790	11.989 0.4720	4.1 0.16	1.5 0.06	72.0 2.83	75.0 2.95	0.8 0.03	99.0 3.90	96.0 3.78	1.2 0.04	1.5 0.06	43.5	29.9	0.0958	0.50 1.10

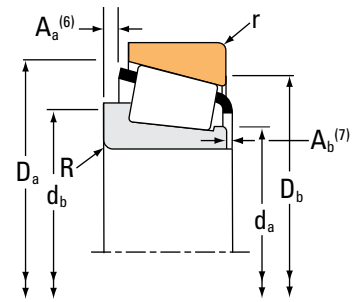
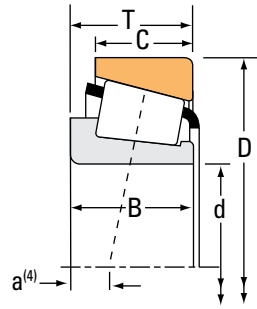
(4) Negative value indicates effective center inside cone (inner-ring) backface.  
 (5) These maximum fillet radii will be cleared by the bearing corners.  
 (6) Negative value indicates cage extends beyond cone (inner-ring) backface.  
 (7) Negative value indicates cage that does not extend beyond cone (inner-ring) front face.

Continued on next page.

# TAPERED ROLLER BEARINGS

## SINGLE-ROW • TYPE TS

### TYPE TS



Bearing Dimensions			Load Ratings							Part Number		
Bore d	O.D. D	Width T	Dynamic <sup>(1)</sup>		Factors <sup>(2)</sup>		Dynamic <sup>(3)</sup>		Factors <sup>(2)</sup>	Static	Inner	Outer
			C <sub>1</sub>	e	Y	C <sub>90</sub>	C <sub>a90</sub>	K	C <sub>0</sub>			
mm in.	mm in.	mm in.	N lbf			N lbf	N lbf			N lbf		
66.675 2.6250	103.213 4.0635	17.602 0.6930	82900 18600	0.49	1.23	21500 4830	17900 4030	1.20		89100 20000	L812148	L812111
66.675 2.6250	107.950 4.2500	25.400 1.0000	131000 29400	0.46	1.31	33800 7610	26600 5970	1.27		161000 36300	29590	29520
66.675 2.6250	107.950 4.2500	25.400 1.0000	131000 29400	0.46	1.31	33800 7610	26600 5970	1.27		161000 36300	29590	29522
66.675 2.6250	110.000 4.3307	22.000 0.8661	98900 22200	0.40	1.49	25600 5760	17600 3970	1.45		125000 28100	395-S	394
66.675 2.6250	110.000 4.3307	22.000 0.8661	98900 22200	0.40	1.49	25600 5760	17600 3970	1.45		125000 28100	395-S	394A
66.675 2.6250	110.000 4.3307	22.000 0.8661	98900 22200	0.40	1.49	25600 5760	17600 3970	1.45		125000 28100	395A	394A
66.675 2.6250	110.000 4.3307	22.000 0.8661	98900 22200	0.40	1.49	25600 5760	17600 3970	1.45		125000 28100	395A	394
66.675 2.6250	110.000 4.3307	22.000 0.8661	98900 22200	0.40	1.49	25600 5760	17600 3970	1.45		125000 28100	395-S	394AS
66.675 2.6250	110.000 4.3307	25.400 1.0000	131000 29400	0.46	1.31	33800 7610	26600 5970	1.27		161000 36300	29590	29521
66.675 2.6250	110.000 4.3307	30.162 1.1875	139000 31200	0.40	1.49	36000 8090	24800 5570	1.45		191000 43000	3984	3927X
66.675 2.6250	110.000 4.3307	30.162 1.1875	139000 31200	0.40	1.49	36000 8090	24800 5570	1.45		191000 43000	3994	3927X
66.675 2.6250	112.712 4.4375	22.225 0.8750	98900 22200	0.40	1.49	25600 5760	17600 3970	1.45		125000 28100	395A	393A
66.675 2.6250	112.712 4.4375	26.967 1.0617	98900 22200	0.40	1.49	25600 5760	17600 3970	1.45		125000 28100	395A	3920
66.675 2.6250	112.712 4.4375	26.967 1.0617	98900 22200	0.40	1.49	25600 5760	17600 3970	1.45		125000 28100	395-S	3920
66.675 2.6250	112.712 4.4375	29.337 1.1550	139000 31200	0.40	1.49	36000 8090	24800 5570	1.45		191000 43000	3992	3920
66.675 2.6250	112.712 4.4375	30.162 1.1875	139000 31200	0.40	1.49	36000 8090	24800 5570	1.45		191000 43000	3984	3920
66.675 2.6250	112.712 4.4375	30.162 1.1875	139000 31200	0.40	1.49	36000 8090	24800 5570	1.45		191000 43000	3994	3920

<sup>(1)</sup>Based on  $1 \times 10^6$  revolutions  $L_{10}$  life, for the ISO life-calculation method.

<sup>(2)</sup>Consult your Timken engineer for instructions on use or review the Timken Engineering Manual on [timken.com/catalogs](http://timken.com/catalogs).

<sup>(3)</sup>Based on  $90 \times 10^6$  revolutions  $L_{10}$  life, for The Timken Company life-calculation method.  $C_{90}$  and  $C_{a90}$  are radial and thrust values.

Bearing Dimensions											Geometry Factors			Bearing Weight
Width B	Width C	Eff. Ctr. a <sup>(4)</sup>	Shaft			Housing			Cage		G <sub>1</sub>	G <sub>2</sub>	C <sub>g</sub>	
			Max Shaft Fillet Radius R <sup>(5)</sup>	Backing Shoulder Dia. d <sub>a</sub>	Shoulder Dia. d <sub>b</sub>	Max Housing Fillet Radius r <sup>(5)</sup>	Backing Shoulder Dia. D <sub>a</sub>	Shoulder Dia. D <sub>b</sub>	A <sub>a</sub> <sup>(6)</sup>	A <sub>b</sub> <sup>(7)</sup>				
mm in.	mm in.	mm in.	mm in.	mm in.	mm in.	mm in.	mm in.	mm in.	mm in.	mm in.				kg lbs.
17.602 0.6930	11.989 0.4720	3.6 0.14	1.5 0.06	72.0 2.83	75.0 2.95	0.8 0.03	99.0 3.90	96.0 3.78	1.6 0.06	1.5 0.06	43.5	29.9	0.0958	0.51 1.11
25.400 1.0000	19.050 0.7500	-0.8 -0.03	3.5 0.14	73.0 2.87	80.0 3.15	3.3 0.13	103.0 4.06	96.0 3.78	2.1 0.08	1.4 0.06	70.3	25.9	0.1112	0.84 1.86
25.400 1.0000	19.050 0.7500	-0.8 -0.03	3.5 0.14	73.0 2.87	80.0 3.15	0.8 0.03	103.0 4.06	98.0 3.86	2.1 0.08	1.4 0.06	70.3	25.9	0.1112	0.85 1.89
21.996 0.8660	22.000 0.8661	-0.8 -0.03	3.5 0.14	73.0 2.87	79.0 3.11	0.8 0.03	106.2 4.18	101.0 3.98	1.6 0.06	2.3 0.09	56.0	21.4	0.0984	0.80 1.77
21.996 0.8660	18.824 0.7411	-0.8 -0.03	3.5 0.14	73.0 2.87	79.0 3.11	1.3 0.05	105.0 4.13	101.0 3.98	1.6 0.06	2.3 0.09	56.0	21.4	0.0984	0.78 1.72
21.996 0.8660	18.824 0.7411	-0.8 -0.03	0.8 0.03	73.0 2.87	73.0 2.87	1.3 0.05	105.0 4.13	101.0 3.98	1.7 0.07	2.1 0.08	56.0	21.4	0.0984	0.78 1.73
21.996 0.8660	22.000 0.8661	-0.8 -0.03	0.8 0.03	73.0 2.87	73.0 2.87	0.8 0.03	106.2 4.18	101.0 3.98	1.7 0.07	2.1 0.08	56.0	21.4	0.0984	0.80 1.77
21.996 0.8660	18.824 0.7411	-0.8 -0.03	3.5 0.14	73.0 2.87	79.0 3.11	3.3 0.13	104.5 4.11	99.0 3.90	1.6 0.06	2.3 0.09	56.0	21.4	0.0984	0.77 1.69
25.400 1.0000	19.050 0.7500	-0.8 -0.03	3.5 0.14	73.0 2.87	80.0 3.15	1.3 0.05	104.0 4.09	99.0 3.90	2.1 0.08	1.4 0.06	70.3	25.9	0.1112	0.91 2.01
30.048 1.1830	23.812 0.9375	-4.6 -0.18	3.5 0.14	74.0 2.91	80.0 3.15	3.3 0.13	105.0 4.13	99.0 3.90	2.3 0.09	1.0 0.04	75.2	21.3	0.1092	1.05 2.33
30.048 1.1830	23.812 0.9375	-4.6 -0.18	5.5 0.22	75.0 2.95	86.0 3.39	3.3 0.13	105.0 4.13	99.0 3.90	2.2 0.08	1.2 0.05	75.2	21.3	0.1092	1.05 2.34
21.996 0.8660	15.875 0.6250	-0.8 -0.03	0.8 0.03	73.0 2.87	73.0 2.87	3.3 0.13	105.0 4.13	100.0 3.94	1.7 0.07	2.1 0.08	56.0	21.4	0.0984	0.81 1.79
21.996 0.8660	23.812 0.9375	-0.8 -0.03	0.8 0.03	73.0 2.87	73.0 2.87	3.3 0.13	106.0 4.17	99.0 3.90	1.7 0.07	2.1 0.08	56.0	21.4	0.0984	0.97 2.15
21.996 0.8660	23.812 0.9375	-0.8 -0.03	3.5 0.14	73.0 2.87	79.0 3.11	3.3 0.13	106.0 4.17	99.0 3.90	1.6 0.06	2.3 0.09	56.0	21.4	0.0984	0.97 2.14
29.223 1.1505	23.812 0.9375	-3.8 -0.15	5.5 0.22	75.0 2.95	86.0 3.39	3.3 0.13	106.0 4.17	99.0 3.90	1.3 0.05	1.2 0.05	75.2	21.3	0.1092	1.14 2.52
30.048 1.1830	23.812 0.9375	-4.6 -0.18	3.5 0.14	74.0 2.91	80.0 3.15	3.3 0.13	106.0 4.17	99.0 3.90	2.3 0.09	1.0 0.04	75.2	21.3	0.1092	1.15 2.55
30.048 1.1830	23.812 0.9375	-4.6 -0.18	5.5 0.22	75.0 2.95	86.0 3.39	3.3 0.13	106.0 4.17	99.0 3.90	2.2 0.08	1.2 0.05	75.2	21.3	0.1092	1.15 2.56

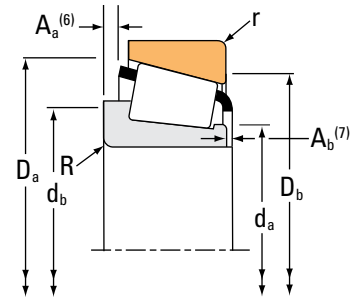
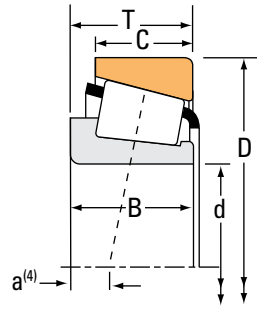
(4) Negative value indicates effective center inside cone (inner-ring) backface.  
 (5) These maximum fillet radii will be cleared by the bearing corners.  
 (6) Negative value indicates cage extends beyond cone (inner-ring) backface.  
 (7) Negative value indicates cage that does not extend beyond cone (inner-ring) front face.

Continued on next page.

# TAPERED ROLLER BEARINGS

## SINGLE-ROW • TYPE TS

### TYPE TS



Bearing Dimensions			Load Ratings							Part Number			
Bore d	O.D. D	Width T	Dynamic <sup>(1)</sup>		Factors <sup>(2)</sup>		Dynamic <sup>(3)</sup>		Factors <sup>(2)</sup>		Static C <sub>0</sub>	Inner	Outer
			C <sub>1</sub>	e	Y	C <sub>90</sub>	C <sub>a90</sub>	K	N	N			
mm in.	mm in.	mm in.	N lbf			N lbf	N lbf		N lbf				
66.675 2.6250	112.712 4.4375	30.162 1.1875	167000 37500	0.34	1.77	43300 9730	25100 5650	1.72	224000 50300			39590	39520
66.675 2.6250	112.712 4.4375	30.162 1.1875	139000 31200	0.40	1.49	36000 8090	24800 5570	1.45	191000 43000			3984	3925
66.675 2.6250	112.712 4.4375	30.162 1.1875	167000 37500	0.34	1.77	43300 9730	25100 5650	1.72	224000 50300			39589	39520
66.675 2.6250	112.712 4.4375	30.162 1.1875	167000 37500	0.34	1.77	43300 9730	25100 5650	1.72	224000 50300			39590	39521
66.675 2.6250	112.712 4.4375	30.162 1.1875	167000 37500	0.34	1.77	43300 9730	25100 5650	1.72	224000 50300			39591	39520
66.675 2.6250	112.712 4.4375	30.162 1.1875	139000 31200	0.40	1.49	36000 8090	24800 5570	1.45	191000 43000			3994	3925
66.675 2.6250	112.712 4.4375	33.338 1.3125	139000 31200	0.40	1.49	36000 8090	24800 5570	1.45	191000 43000			3984	3926
66.675 2.6250	112.712 4.4375	33.338 1.3125	139000 31200	0.40	1.49	36000 8090	24800 5570	1.45	191000 43000			3994	3926
66.675 2.6250	117.475 4.6250	30.162 1.1875	138000 31100	0.44	1.38	35900 8060	26800 6020	1.34	197000 44300			33262	33462
66.675 2.6250	117.475 4.6250	30.162 1.1875	138000 31100	0.44	1.38	35900 8060	26800 6020	1.34	197000 44300			33261	33462
66.675 2.6250	117.475 4.6250	30.162 1.1875	138000 31100	0.44	1.38	35900 8060	26800 6020	1.34	197000 44300			33262	33461
66.675 2.6250	120.000 4.7244	29.002 1.1418	143000 32200	0.38	1.56	37200 8360	24500 5500	1.52	186000 41900			479	472A
66.675 2.6250	120.000 4.7244	29.794 1.1730	138000 31100	0.44	1.38	35900 8060	26800 6020	1.34	197000 44300			33262	33472
66.675 2.6250	120.000 4.7244	29.794 1.1730	143000 32200	0.38	1.56	37200 8360	24500 5500	1.52	186000 41900			479	472
66.675 2.6250	122.238 4.8125	38.100 1.5000	267000 60000	0.34	1.78	69200 15600	40000 8990	1.73	279000 62700			HM212049	HM212011
66.675 2.6250	122.238 4.8125	38.100 1.5000	267000 60000	0.34	1.78	69200 15600	40000 8990	1.73	279000 62700			HM212049	HM212010
66.675 2.6250	122.238 4.8125	38.100 1.5000	267000 60000	0.34	1.78	69200 15600	40000 8990	1.73	279000 62700			HM212049X	HM212010

<sup>(1)</sup>Based on  $1 \times 10^6$  revolutions  $L_{10}$  life, for the ISO life-calculation method.

<sup>(2)</sup>Consult your Timken engineer for instructions on use or review the Timken Engineering Manual on [timken.com/catalogs](http://timken.com/catalogs).

<sup>(3)</sup>Based on  $90 \times 10^6$  revolutions  $L_{10}$  life, for The Timken Company life-calculation method.  $C_{90}$  and  $C_{a90}$  are radial and thrust values.



Bearing Dimensions											Geometry Factors			Bearing Weight
Width B	Width C	Eff. Ctr. a <sup>(4)</sup>	Shaft			Housing			Cage		G <sub>1</sub>	G <sub>2</sub>	C <sub>g</sub>	
			Max Shaft Fillet Radius R <sup>(5)</sup>	Backing Shoulder Dia. d <sub>a</sub>	Shoulder Dia. d <sub>b</sub>	Max Housing Fillet Radius r <sup>(5)</sup>	Backing Shoulder Dia. D <sub>a</sub>	Shoulder Dia. D <sub>b</sub>	A <sub>a</sub> <sup>(6)</sup>	A <sub>b</sub> <sup>(7)</sup>				
mm in.	mm in.	mm in.	mm in.	mm in.	mm in.	mm in.	mm in.	mm in.	mm in.	mm in.				kg lbs.
30.162 1.1875	23.812 0.9375	-6.6 -0.26	3.5 0.14	75.0 2.95	82.0 3.23	3.3 0.13	107.0 4.21	101.0 3.98	1.6 0.06	2.7 0.11	84.3	23.7	0.1074	1.16 2.56
30.048 1.1830	23.812 0.9375	-4.6 -0.18	3.5 0.14	74.0 2.91	80.0 3.15	0.8 0.03	106.0 4.17	101.0 3.98	2.3 0.09	1.0 0.04	75.2	21.3	0.1092	1.16 2.56
30.162 1.1875	23.812 0.9375	-6.6 -0.26	1.5 0.06	75.0 2.95	78.0 3.07	3.3 0.13	107.0 4.21	101.0 3.98	1.6 0.06	2.7 0.11	84.3	23.7	0.1074	1.17 2.57
30.162 1.1875	23.812 0.9375	-6.6 -0.26	3.5 0.14	75.0 2.95	82.0 3.23	0.8 0.03	107.0 4.21	103.0 4.06	1.6 0.06	2.7 0.11	84.3	23.7	0.1074	1.16 2.57
30.162 1.1875	23.812 0.9375	-6.6 -0.26	5.5 0.22	74.0 2.91	84.0 3.31	3.3 0.13	107.0 4.21	101.0 3.98	1.6 0.06	2.7 0.11	84.3	23.7	0.1074	1.14 2.51
30.048 1.1830	23.812 0.9375	-4.6 -0.18	5.5 0.22	75.0 2.95	86.0 3.39	0.8 0.03	106.0 4.17	101.0 3.98	2.2 0.08	1.2 0.05	75.2	21.3	0.1092	1.16 2.57
30.048 1.1830	26.988 1.0625	-4.6 -0.18	3.5 0.14	74.0 2.91	80.0 3.15	3.3 0.13	106.0 4.17	98.0 3.86	2.3 0.09	1.0 0.04	75.2	21.3	0.1092	1.23 2.73
30.048 1.1830	26.988 1.0625	-4.6 -0.18	5.5 0.22	75.0 2.95	86.0 3.39	3.3 0.13	106.0 4.17	98.0 3.86	2.2 0.08	1.2 0.05	75.2	21.3	0.1092	1.23 2.73
30.162 1.1875	23.812 0.9375	-2.8 -0.11	3.5 0.14	75.0 2.95	81.0 3.19	3.3 0.13	112.0 4.41	104.0 4.09	2.2 0.08	1.1 0.05	84.2	25.9	0.1162	1.33 2.94
30.162 1.1875	23.812 0.9375	-2.8 -0.11	5.5 0.22	75.0 2.95	85.0 3.35	3.3 0.13	112.0 4.41	104.0 4.09	2.2 0.08	1.1 0.05	84.2	25.9	0.1162	1.32 2.90
30.162 1.1875	23.812 0.9375	-2.8 -0.11	3.5 0.14	75.0 2.95	81.0 3.19	0.8 0.03	112.0 4.41	106.0 4.17	2.2 0.08	1.1 0.05	84.2	25.9	0.1162	1.34 2.97
29.007 1.1420	23.444 0.9230	-4.1 -0.16	2.3 0.09	74.0 2.91	78.0 3.07	3.3 0.13	114.0 4.49	106.0 4.17	1.5 0.05	2.2 0.09	77.2	23.0	0.1083	1.37 3.00
30.162 1.1875	23.444 0.9230	-2.8 -0.11	3.5 0.14	75.0 2.95	81.0 3.19	0.8 0.03	113.0 4.45	107.0 4.21	2.2 0.08	1.1 0.05	84.2	25.9	0.1162	1.42 3.14
29.007 1.1420	24.237 0.9542	-4.1 -0.16	2.3 0.09	74.0 2.91	78.0 3.07	2.0 0.08	114.0 4.49	107.0 4.21	1.5 0.05	2.2 0.09	77.2	23.0	0.1083	1.40 3.07
38.354 1.5100	29.718 1.1700	-10.9 -0.43	3.5 0.14	75.5 2.97	82.0 3.23	3.3 0.13	116.0 4.57	108.0 4.25	2.2 0.08	3.1 0.12	92.2	18.1	0.0759	1.85 4.06
38.354 1.5100	29.718 1.1700	-10.9 -0.43	3.5 0.14	75.5 2.97	82.0 3.23	1.5 0.06	116.0 4.57	110.0 4.33	2.2 0.08	3.1 0.12	92.2	18.1	0.0759	1.85 4.07
38.354 1.5100	29.718 1.1700	-10.9 -0.43	7.0 0.28	75.5 2.97	89.0 3.50	1.5 0.06	116.0 4.57	110.0 4.33	2.2 0.08	3.1 0.12	92.2	18.1	0.0759	1.84 4.05

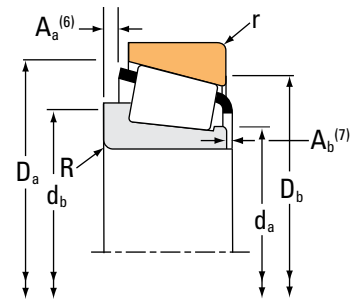
<sup>(4)</sup>Negative value indicates effective center inside cone (inner-ring) backface.  
<sup>(5)</sup>These maximum fillet radii will be cleared by the bearing corners.  
<sup>(6)</sup>Negative value indicates cage extends beyond cone (inner-ring) backface.  
<sup>(7)</sup>Negative value indicates cage that does not extend beyond cone (inner-ring) front face.

Continued on next page.

# TAPERED ROLLER BEARINGS

## SINGLE-ROW • TYPE TS

### TYPE TS



Bearing Dimensions			Load Ratings							Part Number			
Bore d	O.D. D	Width T	Dynamic <sup>(1)</sup>		Factors <sup>(2)</sup>		Dynamic <sup>(3)</sup>		Factors <sup>(2)</sup>		Static C <sub>0</sub>	Inner	Outer
			C <sub>1</sub>	e	Y	C <sub>90</sub>	C <sub>a90</sub>	K	N	N			
mm in.	mm in.	mm in.	N lbf			N lbf	N lbf		N lbf				
66.675 2.6250	123.825 4.8750	30.162 1.1875	143000 32200	0.38	1.56	37200 8360	24500 5500	1.52	186000 41900		479	472X	
66.675 2.6250	123.825 4.8750	38.100 1.5000	226000 50800	0.35	1.73	58600 13200	34700 7810	1.69	248000 55700		560	552	
66.675 2.6250	123.825 4.8750	38.100 1.5000	226000 50800	0.35	1.73	58600 13200	34700 7810	1.69	248000 55700		560	552A	
66.675 2.6250	127.000 5.0000	36.512 1.4375	229000 51500	0.50	1.20	59400 13400	51100 11500	1.16	256000 57600		HM813844	HM813811	
66.675 2.6250	127.000 5.0000	36.512 1.4375	229000 51500	0.50	1.20	59400 13400	51100 11500	1.16	256000 57600		HM813844	HM813810	
66.675 2.6250	129.944 5.1159	38.100 1.5000	226000 50800	0.35	1.73	58600 13200	34700 7810	1.69	248000 55700		560	553-SA	
66.675 2.6250	130.175 5.1250	41.275 1.6250	276000 62100	0.36	1.66	71600 16100	44400 9980	1.61	298000 67000		641	633	
66.675 2.6250	135.755 5.3447	53.975 2.1250	321000 72300	0.32	1.85	83300 18700	46300 10400	1.80	404000 90900		6386	6320	
66.675 2.6250	135.755 5.3447	53.975 2.1250	321000 72300	0.32	1.85	83300 18700	46300 10400	1.80	404000 90900		6389	6320	
66.675 2.6250	135.755 5.3447	53.975 2.1250	321000 72300	0.32	1.85	83300 18700	46300 10400	1.80	404000 90900		6386A	6320	
66.675 2.6250	136.525 5.3750	30.162 1.1875	154000 34700	0.44	1.35	40000 9000	30500 6850	1.31	216000 48600		495AA	493	
66.675 2.6250	136.525 5.3750	41.275 1.6250	276000 62100	0.36	1.66	71600 16100	44400 9980	1.61	298000 67000		641	632	
66.675 2.6250	136.525 5.3750	41.275 1.6250	323000 72600	0.36	1.67	83700 18800	51600 11600	1.62	335000 75400		H414242	H414210	
66.675 2.6250	136.525 5.3750	46.038 1.8125	319000 71700	0.47	1.27	82700 18600	67000 15100	1.24	405000 91000		H715341	H715311	
66.675 2.6250	136.525 5.3750	46.038 1.8125	319000 71700	0.47	1.27	82700 18600	67000 15100	1.24	405000 91000		H715341	H715311A	
66.675 2.6250	136.525 5.3750	46.038 1.8125	249000 56000	0.47	1.27	64600 14500	52300 11800	1.24	405000 91000		H715341A	H715311	
66.675 2.6250	139.700 5.5000	46.038 1.8125	319000 71700	0.47	1.27	82700 18600	67000 15100	1.24	405000 91000		H715341	H715310	

<sup>(1)</sup>Based on 1 x 10<sup>6</sup> revolutions L<sub>10</sub> life, for the ISO life-calculation method.

<sup>(2)</sup>Consult your Timken engineer for instructions on use or review the Timken Engineering Manual on timken.com/catalogs.

<sup>(3)</sup>Based on 90 x 10<sup>6</sup> revolutions L<sub>10</sub> life, for The Timken Company life-calculation method. C<sub>90</sub> and C<sub>a90</sub> are radial and thrust values.

Bearing Dimensions											Geometry Factors			Bearing Weight
Width B	Width C	Eff. Ctr. a <sup>(4)</sup>	Shaft			Housing			Cage		G <sub>1</sub>	G <sub>2</sub>	C <sub>g</sub>	
			Max Shaft Fillet Radius R <sup>(5)</sup>	Backing Shoulder Dia. d <sub>a</sub>	Backing Shoulder Dia. d <sub>b</sub>	Max Housing Fillet Radius r <sup>(5)</sup>	Backing Shoulder Dia. D <sub>a</sub>	Backing Shoulder Dia. D <sub>b</sub>	A <sub>a</sub> <sup>(6)</sup>	A <sub>b</sub> <sup>(7)</sup>				
mm in.	mm in.	mm in.	mm in.	mm in.	mm in.	mm in.	mm in.	mm in.	mm in.	mm in.				kg lbs.
29.007 1.1420	24.605 0.9687	-4.1 -0.16	2.3 0.09	74.0 2.91	78.0 3.07	3.3 0.13	115.0 4.53	109.0 4.29	1.5 0.05	2.2 0.09	77.2	23.0	0.1083	1.54 3.37
36.678 1.4440	33.338 1.3125	-9.4 -0.37	3.5 0.14	77.0 3.03	84.0 3.31	3.3 0.13	116.0 4.57	109.0 4.29	2.3 0.09	1.3 0.05	91.0	21.1	0.1108	1.94 4.27
36.678 1.4440	30.162 1.1875	-9.4 -0.37	3.5 0.14	77.0 3.03	84.0 3.31	3.3 0.13	116.0 4.57	109.0 4.29	2.3 0.09	1.3 0.05	91.0	21.1	0.1108	1.89 4.16
36.512 1.4375	26.988 1.0625	-3.8 -0.15	3.5 0.14	82.0 3.23	88.0 3.46	1.5 0.06	121.0 4.76	113.0 4.45	4.0 0.15	1.3 0.06	91.7	22.9	0.1252	1.99 4.41
36.512 1.4375	26.988 1.0625	-3.8 -0.15	3.5 0.14	82.0 3.23	88.0 3.46	3.3 0.13	121.0 4.76	111.0 4.37	4.0 0.15	1.3 0.06	91.7	22.9	0.1252	1.99 4.40
36.678 1.4440	30.162 1.1875	-9.4 -0.37	3.5 0.14	77.0 3.03	84.0 3.31	3.3 0.13	116.0 4.57	111.0 4.37	2.3 0.09	1.3 0.05	91.0	21.1	0.1108	2.18 4.79
41.275 1.6250	31.750 1.2500	-11.2 -0.44	3.5 0.14	77.0 3.03	83.0 3.27	3.3 0.13	124.0 4.88	116.0 4.57	4.1 0.16	2.0 0.08	106.4	21.0	0.0814	2.38 5.24
56.007 2.2050	44.450 1.7500	-19.3 -0.76	4.3 0.17	77.0 3.04	87.0 3.43	3.3 0.13	126.0 4.96	117.0 4.61	4.0 0.15	0.5 0.02	123.5	22.4	0.0827	3.55 7.84
56.007 2.2050	44.450 1.7500	-19.3 -0.76	6.4 0.25	77.0 3.04	91.0 3.58	3.3 0.13	126.0 4.96	117.0 4.61	4.0 0.15	0.5 0.02	123.5	22.4	0.0827	3.53 7.80
56.007 2.2050	44.450 1.7500	-19.3 -0.76	8.7 0.34	77.0 3.04	96.0 3.78	3.3 0.13	126.0 4.96	117.0 4.61	4.0 0.15	0.5 0.02	123.5	22.4	0.0827	3.50 7.72
29.769 1.1720	22.225 0.8750	-0.8 -0.03	3.5 0.14	78.0 3.07	85.0 3.35	3.3 0.13	130.0 5.12	122.0 4.80	2.5 0.09	2.2 0.09	104.6	29.3	0.1252	2.05 4.51
41.275 1.6250	31.750 1.2500	-11.2 -0.44	3.5 0.14	77.0 3.03	83.0 3.27	3.3 0.13	125.0 4.92	118.0 4.65	4.1 0.16	2.0 0.08	106.4	21.0	0.0814	2.72 5.99
41.275 1.6250	31.750 1.2500	-10.9 -0.43	3.5 0.14	81.0 3.19	85.0 3.35	3.3 0.13	129.0 5.08	121.0 4.76	3.7 0.14	3.1 0.12	112.8	22.9	0.0827	2.71 5.99
46.038 1.8125	36.512 1.4375	-8.6 -0.34	3.5 0.14	85.0 3.35	91.0 3.58	3.3 0.13	132.0 5.20	118.0 4.65	4.1 0.16	2.0 0.08	147.1	33.5	0.0993	3.30 7.27
46.038 1.8125	36.512 1.4375	-8.6 -0.34	3.5 0.14	85.0 3.35	91.0 3.58	0.8 0.03	132.0 5.20	121.0 4.76	4.1 0.16	2.0 0.08	147.1	33.5	0.0993	3.30 7.27
46.038 1.8125	36.512 1.4375	-8.6 -0.34	7.0 0.28	85.0 3.35	98.0 3.86	3.3 0.13	132.0 5.20	118.0 4.65	4.1 0.16	2.0 0.08	147.1	33.5	0.0993	3.28 7.23
46.038 1.8125	36.512 1.4375	-8.6 -0.34	3.5 0.14	85.0 3.35	91.0 3.58	3.3 0.13	133.0 5.24	120.0 4.72	4.1 0.16	2.0 0.08	147.1	33.5	0.0993	3.48 7.67

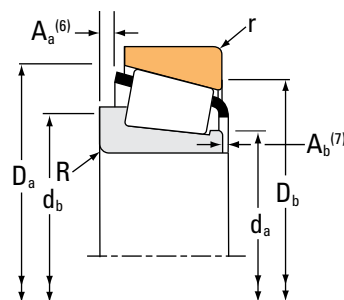
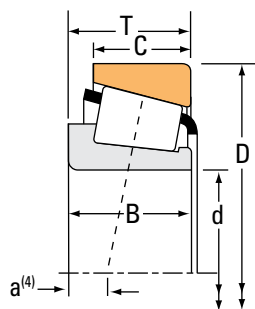
(4) Negative value indicates effective center inside cone (inner-ring) backface.  
 (5) These maximum fillet radii will be cleared by the bearing corners.  
 (6) Negative value indicates cage extends beyond cone (inner-ring) backface.  
 (7) Negative value indicates cage that does not extend beyond cone (inner-ring) front face.

Continued on next page.

# TAPERED ROLLER BEARINGS

## SINGLE-ROW • TYPE TS

### TYPE TS



Bearing Dimensions			Load Ratings							Part Number			
Bore d	O.D. D	Width T	Dynamic <sup>(1)</sup>		Factors <sup>(2)</sup>		Dynamic <sup>(3)</sup>		Factors <sup>(2)</sup>		Static C <sub>0</sub>	Inner	Outer
			C <sub>1</sub>	e	Y	C <sub>90</sub>	C <sub>a90</sub>	K	N	N			
mm in.	mm in.	mm in.	N lbf			N lbf	N lbf		N lbf				
66.675 2.6250	152.400 6.0000	53.975 2.1250	339000 76100	0.49	1.23	87800 19700	73200 16500	1.20	423000 95000			HH814547	HH814510
66.675 2.6250	177.800 7.0000	57.150 2.2500	451000 101000	0.80	0.75	117000 26300	160000 35900	0.73	413000 92900			HH914449	HH914412
68.262 2.6875	110.000 4.3307	22.000 0.8661	98900 22200	0.40	1.49	25600 5760	17600 3970	1.45	125000 28100			399A	394A
68.262 2.6875	110.000 4.3307	22.000 0.8661	98900 22200	0.40	1.49	25600 5760	17600 3970	1.45	125000 28100			399AS	394A
68.262 2.6875	111.125 4.3750	22.000 0.8661	98900 22200	0.40	1.49	25600 5760	17600 3970	1.45	125000 28100			399A	393AS
68.262 2.6875	112.712 4.4375	26.967 1.0617	98900 22200	0.40	1.49	25600 5760	17600 3970	1.45	125000 28100			399AS	3920
68.262 2.6875	112.712 4.4375	26.967 1.0617	98900 22200	0.40	1.49	25600 5760	17600 3970	1.45	125000 28100			399A	3920
68.262 2.6875	120.000 4.7244	29.002 1.1418	143000 32200	0.38	1.56	37200 8360	24500 5500	1.52	186000 41900			480	472A
68.262 2.6875	120.000 4.7244	29.794 1.1730	143000 32200	0.38	1.56	37200 8360	24500 5500	1.52	186000 41900			480	473
68.262 2.6875	120.000 4.7244	29.794 1.1730	138000 31100	0.44	1.38	35900 8060	26800 6020	1.34	197000 44300			33269	33472
68.262 2.6875	120.000 4.7244	29.795 1.1730	143000 32200	0.38	1.56	37200 8360	24500 5500	1.52	186000 41900			480	472
68.262 2.6875	123.825 4.8750	34.912 1.3745	191000 42900	0.35	1.73	49400 11100	29300 6590	1.69	248000 55700			560-S	552-S
68.262 2.6875	123.825 4.8750	38.100 1.5000	191000 42900	0.35	1.73	49400 11100	29300 6590	1.69	248000 55700			560-S	552A
68.262 2.6875	123.825 4.8750	38.100 1.5000	191000 42900	0.35	1.73	49400 11100	29300 6590	1.69	248000 55700			560-S	552
68.262 2.6875	127.000 5.0000	36.512 1.4375	196000 44100	0.36	1.65	50900 11400	31700 7130	1.61	262000 58900			570	563
68.262 2.6875	130.048 5.1200	36.512 1.4375	196000 44100	0.36	1.65	50900 11400	31700 7130	1.61	262000 58900			570	562
68.262 2.6875	130.175 5.1250	41.275 1.6250	233000 52400	0.36	1.66	60400 13600	37400 8420	1.61	298000 67000			642	633

<sup>(1)</sup>Based on 1 x 10<sup>6</sup> revolutions L<sub>10</sub> life, for the ISO life-calculation method.

<sup>(2)</sup>Consult your Timken engineer for instructions on use or review the Timken Engineering Manual on timken.com/catalogs.

<sup>(3)</sup>Based on 90 x 10<sup>6</sup> revolutions L<sub>10</sub> life, for The Timken Company life-calculation method. C<sub>90</sub> and C<sub>a90</sub> are radial and thrust values.

Bearing Dimensions											Geometry Factors			Bearing Weight
Width B	Width C	Eff. Ctr. a <sup>(4)</sup>	Shaft			Housing			Cage		G <sub>1</sub>	G <sub>2</sub>	C <sub>g</sub>	
			Max Shaft Fillet Radius R <sup>(5)</sup>	Backing Shoulder Dia. d <sub>a</sub>	Shoulder Dia. d <sub>b</sub>	Max Housing Fillet Radius r <sup>(5)</sup>	Backing Shoulder Dia. D <sub>a</sub>	Shoulder Dia. D <sub>b</sub>	A <sub>a</sub> <sup>(6)</sup>	A <sub>b</sub> <sup>(7)</sup>				
mm in.	mm in.	mm in.	mm in.	mm in.	mm in.	mm in.	mm in.	mm in.	mm in.	mm in.				kg lbs.
57.150 2.2500	41.275 1.6250	-12.2 -0.48	3.5 0.14	85.0 3.35	93.0 3.66	3.3 0.13	143.0 5.63	130.0 5.12	5.2 0.20	0.2 0.01	129.7	23.6	0.0957	4.80 10.57
53.975 2.1250	37.308 1.4688	-0.3 -0.01	3.5 0.14	85.3 3.36	106.0 4.17	3.3 0.13	165.0 6.50	146.0 5.75	9.8 0.38	4.7 0.19	111.4	17.8	0.1044	6.66 14.66
21.996 0.8660	18.824 0.7411	-0.8 -0.03	2.3 0.09	74.0 2.91	78.0 3.07	1.3 0.05	105.0 4.13	101.0 3.98	1.7 0.07	2.1 0.08	56.0	21.4	0.0984	0.75 1.65
21.996 0.8660	18.824 0.7411	-0.8 -0.03	5.0 0.20	74.0 2.91	83.0 3.27	1.3 0.05	105.0 4.13	101.0 3.98	1.6 0.06	2.3 0.09	56.0	21.4	0.0984	0.73 1.61
21.996 0.8660	18.824 0.7411	-0.8 -0.03	2.3 0.09	74.0 2.91	78.0 3.07	1.3 0.05	105.0 4.13	101.0 3.98	1.7 0.07	2.1 0.08	56.0	21.4	0.0984	0.78 1.71
21.996 0.8660	23.812 0.9375	-0.8 -0.03	5.0 0.20	74.0 2.91	83.0 3.27	3.3 0.13	106.0 4.17	99.0 3.90	1.6 0.06	2.3 0.09	56.0	21.4	0.0984	0.92 2.03
21.996 0.8660	23.812 0.9375	-0.8 -0.03	2.3 0.09	74.0 2.91	78.0 3.07	3.3 0.13	106.0 4.17	99.0 3.90	1.7 0.07	2.1 0.08	56.0	21.4	0.0984	0.94 2.07
29.007 1.1420	23.444 0.9230	-4.1 -0.16	3.5 0.14	75.0 2.95	82.0 3.23	3.3 0.13	114.0 4.49	106.0 4.17	1.5 0.05	2.2 0.09	77.2	23.0	0.1083	1.32 2.90
29.007 1.1420	29.000 1.1417	-4.1 -0.16	3.5 0.14	75.0 2.95	82.0 3.23	2.0 0.08	114.0 4.49	107.0 4.21	1.5 0.05	2.2 0.09	77.2	23.0	0.1083	1.40 3.08
30.162 1.1875	23.444 0.9230	-2.8 -0.11	3.5 0.14	76.0 2.99	82.0 3.23	0.8 0.03	113.0 4.45	107.0 4.21	2.2 0.08	1.1 0.05	84.2	25.9	0.1162	1.38 3.05
29.007 1.1420	24.237 0.9542	-4.1 -0.16	3.5 0.14	75.0 2.95	82.0 3.23	2.0 0.08	114.0 4.49	107.0 4.21	1.5 0.05	2.2 0.09	77.2	23.0	0.1083	1.35 2.97
36.678 1.4440	26.975 1.0620	-9.4 -0.37	3.5 0.14	76.0 2.99	83.0 3.27	4.8 0.19	115.0 4.53	107.0 4.21	2.3 0.09	1.3 0.05	91.0	21.1	0.1108	1.72 3.77
36.678 1.4440	30.162 1.1875	-9.4 -0.37	3.5 0.14	76.0 2.99	83.0 3.27	3.3 0.13	116.0 4.57	109.0 4.29	2.3 0.09	1.3 0.05	91.0	21.1	0.1108	1.84 4.04
36.678 1.4440	33.338 1.3125	-9.4 -0.37	3.5 0.14	76.0 2.99	83.0 3.27	3.3 0.13	116.0 4.57	109.0 4.29	2.3 0.09	1.3 0.05	91.0	21.1	0.1108	1.89 4.15
36.170 1.4240	28.575 1.1250	-8.1 -0.32	3.5 0.14	77.0 3.03	83.0 3.27	3.3 0.13	120.0 4.72	112.0 4.41	3.2 0.12	1.8 0.08	101.3	24.0	0.1167	1.95 4.31
36.170 1.4240	28.575 1.1250	-8.1 -0.32	3.5 0.14	77.0 3.03	83.0 3.27	0.8 0.03	121.0 4.76	116.0 4.57	3.2 0.12	1.8 0.08	101.3	24.0	0.1167	2.10 4.62
41.275 1.6250	31.750 1.2500	-11.2 -0.44	3.5 0.14	78.0 3.07	85.0 3.35	3.3 0.13	124.0 4.88	116.0 4.57	4.1 0.16	2.0 0.08	106.4	21.0	0.0814	2.33 5.12

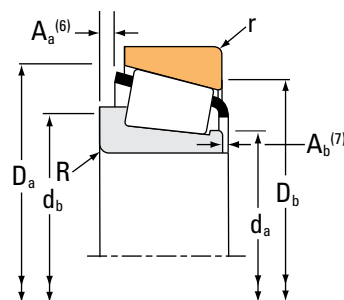
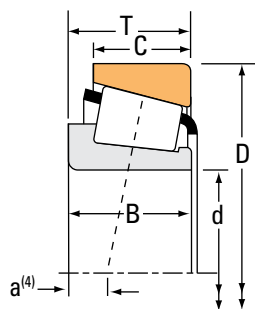
<sup>(4)</sup>Negative value indicates effective center inside cone (inner-ring) backface.  
<sup>(5)</sup>These maximum fillet radii will be cleared by the bearing corners.  
<sup>(6)</sup>Negative value indicates cage extends beyond cone (inner-ring) backface.  
<sup>(7)</sup>Negative value indicates cage that does not extend beyond cone (inner-ring) front face.

Continued on next page.

# TAPERED ROLLER BEARINGS

## SINGLE-ROW • TYPE TS

### TYPE TS



Bearing Dimensions			Load Ratings							Part Number		
Bore d	O.D. D	Width T	Dynamic <sup>(1)</sup>		Factors <sup>(2)</sup>		Dynamic <sup>(3)</sup>		Factors <sup>(2)</sup>	Static	Inner	Outer
			C <sub>1</sub>	e	Y	C <sub>90</sub>	C <sub>a90</sub>	K	C <sub>0</sub>			
mm in.	mm in.	mm in.	N lbf			N lbf	N lbf			N lbf		
68.262 2.6875	136.525 5.3750	41.275 1.6250	233000 52400	0.36	1.66	60400 13600	37400 8420	1.61		298000 67000	642	632
68.262 2.6875	136.525 5.3750	41.275 1.6250	323000 72600	0.36	1.67	83700 18800	51600 11600	1.62		335000 75400	H414245X	H414210
68.262 2.6875	136.525 5.3750	46.038 1.8125	319000 71700	0.47	1.27	82700 18600	67000 15100	1.24		405000 91000	H715343	H715311
68.262 2.6875	139.700 5.5000	46.038 1.8125	319000 71700	0.47	1.27	82700 18600	67000 15100	1.24		405000 91000	H715343	H715310
68.262 2.6875	152.400 6.0000	47.625 1.8750	338000 76000	0.66	0.91	87700 19700	98500 22100	0.89		306000 68700	9185	9121
68.262 2.6875	152.400 6.0000	47.625 1.8750	328000 73700	0.90	0.67	85000 19100	131000 29500	0.65		401000 90100	H914841	H914811
68.262 2.6875	158.750 6.2500	50.800 2.0000	338000 76000	0.66	0.91	87700 19700	98500 22100	0.89		306000 68700	9185	9120
68.262 2.6875	161.925 6.3750	49.212 1.9375	353000 79300	0.71	0.85	91400 20600	111000 24900	0.82		330000 74200	9278	9220
69.850 2.7500	98.425 3.8750	13.495 0.5313	40300 9070	0.44	1.37	10500 2350	7840 1760	1.33		58100 13100	LL713049	LL713010
69.850 2.7500	99.217 3.9062	17.000 0.6693	48800 11000	0.46	1.29	12700 2850	10100 2260	1.26		75000 16900	LL713149	LL713110
69.850 2.7500	101.600 4.0000	19.050 0.7500	61900 13900	0.46	1.30	16000 3610	12700 2850	1.27		111000 25000	L713049	L713010
69.850 2.7500	112.712 4.4375	22.225 0.8750	101000 22700	0.42	1.44	26200 5880	18600 4190	1.40		130000 29300	LM613449	LM613410
69.850 2.7500	112.712 4.4375	25.400 1.0000	111000 24800	0.49	1.23	28600 6440	23900 5370	1.20		166000 37200	29675	29620
69.850 2.7500	114.300 4.5000	27.780 1.0937	111000 24800	0.49	1.23	28600 6440	23900 5370	1.20		166000 37200	29675	29624
69.850 2.7500	117.475 4.6250	30.162 1.1875	138000 31100	0.44	1.38	35900 8060	26800 6020	1.34		197000 44300	33275	33462
69.850 2.7500	120.000 4.7244	29.002 1.1418	143000 32200	0.38	1.56	37200 8360	24500 5500	1.52		186000 41900	482	472A
69.850 2.7500	120.000 4.7244	29.002 1.1418	133000 29900	0.38	1.56	34400 7740	22700 5100	1.52		186000 41900	482A	472A

<sup>(1)</sup>Based on 1 x 10<sup>6</sup> revolutions L<sub>10</sub> life, for the ISO life-calculation method.

<sup>(2)</sup>Consult your Timken engineer for instructions on use or review the Timken Engineering Manual on timken.com/catalogs.

<sup>(3)</sup>Based on 90 x 10<sup>6</sup> revolutions L<sub>10</sub> life, for The Timken Company life-calculation method. C<sub>90</sub> and C<sub>a90</sub> are radial and thrust values.

Bearing Dimensions											Geometry Factors			Bearing Weight
Width B	Width C	Eff. Ctr. a <sup>(4)</sup>	Shaft			Housing			Cage		G <sub>1</sub>	G <sub>2</sub>	C <sub>g</sub>	
			Max Shaft Fillet Radius R <sup>(5)</sup>	Backing Shoulder Dia. d <sub>a</sub>	Shoulder Dia. d <sub>b</sub>	Max Housing Fillet Radius r <sup>(5)</sup>	Backing Shoulder Dia. D <sub>a</sub>	Shoulder Dia. D <sub>b</sub>	A <sub>a</sub> <sup>(6)</sup>	A <sub>b</sub> <sup>(7)</sup>				
mm in.	mm in.	mm in.	mm in.	mm in.	mm in.	mm in.	mm in.	mm in.	mm in.	mm in.				kg lbs.
41.275 1.6250	31.750 1.2500	-11.2 -0.44	3.5 0.14	78.0 3.07	85.0 3.35	3.3 0.13	125.0 4.92	118.0 4.65	4.1 0.16	2.0 0.08	106.4	21.0	0.0814	2.67 5.87
41.275 1.6250	31.750 1.2500	-10.9 -0.43	9.7 0.38	82.0 3.23	98.0 3.86	3.3 0.13	129.0 5.08	121.0 4.76	3.7 0.14	3.1 0.12	112.8	22.9	0.0827	2.58 5.70
46.038 1.8125	36.512 1.4375	-8.6 -0.34	3.5 0.14	86.0 3.39	92.0 3.62	3.3 0.13	132.0 5.20	118.0 4.65	4.1 0.16	2.0 0.08	147.1	33.5	0.0993	3.24 7.13
46.038 1.8125	36.512 1.4375	-8.6 -0.34	3.5 0.14	86.0 3.39	92.0 3.62	3.3 0.13	133.0 5.24	120.0 4.72	4.1 0.16	2.0 0.08	147.1	33.5	0.0993	3.42 7.53
46.038 1.8125	31.750 1.2500	-3.8 -0.15	3.5 0.14	81.3 3.20	94.0 3.70	3.3 0.13	145.0 5.71	130.0 5.12	8.1 0.31	4.1 0.16	87.6	13.7	0.0912	3.75 8.26
46.038 1.8125	35.100 1.3819	7.9 0.31	3.5 0.14	87.0 3.43	108.0 4.25	3.3 0.13	148.0 5.83	123.0 4.84	5.7 0.22	3.2 0.13	135.1	30.3	0.1165	4.40 9.68
46.038 1.8125	34.925 1.3750	-3.8 -0.15	3.5 0.14	81.3 3.20	94.0 3.70	3.3 0.13	146.0 5.75	131.0 5.16	8.1 0.31	4.1 0.16	87.6	13.7	0.0912	4.37 9.63
46.038 1.8125	31.750 1.2500	0.0 0.00	3.5 0.14	89.0 3.50	106.0 4.17	3.3 0.13	153.0 6.03	138.0 5.43	9.0 0.35	4.1 0.16	102.5	16.1	0.0984	4.50 9.93
13.495 0.5313	9.525 0.3750	4.6 0.18	1.5 0.06	74.0 2.91	77.0 3.03	1.5 0.06	94.0 3.70	92.0 3.62	1.0 0.04	1.5 0.06	39.9	55.0	0.0893	0.30 0.65
16.000 0.6299	13.000 0.5118	4.6 0.18	1.5 0.06	75.0 2.95	77.0 3.03	1.5 0.06	95.0 3.74	91.0 3.58	0.6 0.02	0.6 0.03	47.9	56.5	0.0972	0.39 0.85
19.050 0.7500	15.083 0.5938	2.5 0.10	1.5 0.06	75.0 2.95	78.0 3.07	1.5 0.06	98.0 3.86	93.0 3.66	0.8 0.03	1.4 0.06	64.3	58.3	0.1075	0.51 1.11
21.996 0.8660	15.875 0.6250	0.0 0.00	1.5 0.06	76.0 2.99	78.0 3.07	0.8 0.03	107.0 4.21	104.0 4.09	1.7 0.06	2.3 0.09	60.3	23.1	0.1019	0.77 1.71
25.400 1.0000	19.050 0.7500	1.0 0.04	1.5 0.06	77.0 3.03	80.0 3.15	3.3 0.13	109.0 4.29	101.0 3.98	2.3 0.09	1.5 0.06	77.7	43.3	0.1170	0.95 2.11
25.400 1.0000	22.225 0.8750	1.0 0.04	1.5 0.06	77.0 3.03	80.0 3.15	3.3 0.13	109.0 4.29	103.0 4.06	2.3 0.09	1.5 0.06	77.7	43.3	0.1170	1.06 2.34
30.162 1.1875	23.812 0.9375	-2.8 -0.11	3.5 0.14	79.0 3.11	85.0 3.35	3.3 0.13	112.0 4.41	104.0 4.09	2.2 0.08	1.1 0.05	84.2	25.9	0.1162	1.26 2.78
29.007 1.1420	23.444 0.9230	-4.1 -0.16	3.5 0.14	77.0 3.03	83.0 3.27	3.3 0.13	114.0 4.49	106.0 4.17	1.5 0.05	2.2 0.09	77.2	23.0	0.1083	1.28 2.81
29.007 1.1420	23.444 0.9230	-4.1 -0.16	4.8 0.19	77.0 3.03	86.0 3.39	3.3 0.13	114.0 4.49	106.0 4.17	1.5 0.05	2.2 0.09	77.2	23.0	0.1083	1.27 2.79

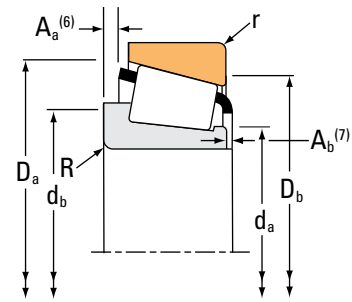
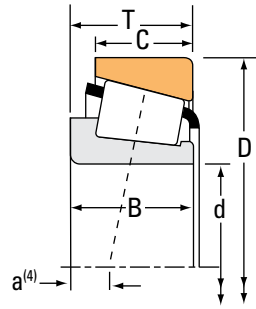
<sup>(4)</sup>Negative value indicates effective center inside cone (inner-ring) backface.  
<sup>(5)</sup>These maximum fillet radii will be cleared by the bearing corners.  
<sup>(6)</sup>Negative value indicates cage extends beyond cone (inner-ring) backface.  
<sup>(7)</sup>Negative value indicates cage that does not extend beyond cone (inner-ring) front face.

Continued on next page.

# TAPERED ROLLER BEARINGS

## SINGLE-ROW • TYPE TS

### TYPE TS



Bearing Dimensions			Load Ratings							Part Number		
Bore d	O.D. D	Width T	Dynamic <sup>(1)</sup>		Factors <sup>(2)</sup>		Dynamic <sup>(3)</sup>		Factors <sup>(2)</sup>	Static	Inner	Outer
			C <sub>1</sub>	e	Y	C <sub>90</sub>	C <sub>a90</sub>	K	C <sub>0</sub>			
mm in.	mm in.	mm in.	N lbf			N lbf	N lbf			N lbf		
69.850 2.7500	120.000 4.7244	29.794 1.1730	143000 32200	0.38	1.56	37200 8360	24500 5500	1.52		186000 41900	482	473
69.850 2.7500	120.000 4.7244	29.794 1.1730	143000 32200	0.38	1.56	37200 8360	24500 5500	1.52		186000 41900	482	472
69.850 2.7500	120.000 4.7244	29.794 1.1730	138000 31100	0.44	1.38	35900 8060	26800 6020	1.34		197000 44300	33275	33472
69.850 2.7500	120.000 4.7244	32.545 1.2813	179000 40200	0.36	1.67	46300 10400	28600 6420	1.62		249000 56000	47487	47420
69.850 2.7500	120.000 4.7244	32.545 1.2813	179000 40200	0.36	1.67	46300 10400	28600 6420	1.62		249000 56000	47487	47420A
69.850 2.7500	120.650 4.7500	25.400 1.0000	111000 24800	0.49	1.23	28600 6440	23900 5370	1.20		166000 37200	29675	29630
69.850 2.7500	123.825 4.8750	30.162 1.1875	143000 32200	0.38	1.56	37200 8360	24500 5500	1.52		186000 41900	482	472X
69.850 2.7500	127.000 5.0000	36.512 1.4375	196000 44100	0.36	1.65	50900 11400	31700 7130	1.61		262000 58900	566	563
69.850 2.7500	127.000 5.0000	36.512 1.4375	196000 44100	0.36	1.65	50900 11400	31700 7130	1.61		262000 58900	566-S	563
69.850 2.7500	127.000 5.0000	36.512 1.4375	229000 51500	0.50	1.20	59400 13400	51100 11500	1.16		256000 57600	HM813846	HM813811
69.850 2.7500	127.000 5.0000	36.512 1.4375	229000 51500	0.50	1.20	59400 13400	51100 11500	1.16		256000 57600	HM813846	HM813810
69.850 2.7500	130.175 5.1250	41.275 1.6250	276000 62100	0.36	1.66	71600 16100	44400 9980	1.61		298000 67000	643	633
69.850 2.7500	136.525 5.3750	41.275 1.6250	276000 62100	0.36	1.66	71600 16100	44400 9980	1.61		298000 67000	643	632
69.850 2.7500	139.700 5.5000	46.038 1.8125	319000 71700	0.47	1.27	82700 18600	67000 15100	1.24		405000 91000	H715344	H715310
69.850 2.7500	146.050 5.7500	36.512 1.4375	174000 39100	0.94	0.64	45000 10100	72300 16200	0.62		202000 45400	HM914545	HM914510
69.850 2.7500	146.050 5.7500	41.275 1.6250	273000 61300	0.78	0.77	70700 15900	94700 21300	0.75		256000 57500	H913849	H913810
69.850 2.7500	146.050 5.7500	41.275 1.6250	247000 55500	0.41	1.47	64000 14400	44800 10100	1.43		335000 75300	655	653

<sup>(1)</sup>Based on  $1 \times 10^6$  revolutions  $L_{10}$  life, for the ISO life-calculation method.

<sup>(2)</sup>Consult your Timken engineer for instructions on use or review the Timken Engineering Manual on [timken.com/catalogs](http://timken.com/catalogs).

<sup>(3)</sup>Based on  $90 \times 10^6$  revolutions  $L_{10}$  life, for The Timken Company life-calculation method.  $C_{90}$  and  $C_{a90}$  are radial and thrust values.



Bearing Dimensions											Geometry Factors			Bearing Weight
Width B	Width C	Eff. Ctr. a <sup>(4)</sup>	Shaft			Housing			Cage		G <sub>1</sub>	G <sub>2</sub>	C <sub>g</sub>	
			Max Shaft Fillet Radius R <sup>(5)</sup>	Backing Shoulder Dia. d <sub>a</sub>	Shoulder Dia. d <sub>b</sub>	Max Housing Fillet Radius r <sup>(5)</sup>	Backing Shoulder Dia. D <sub>a</sub>	Shoulder Dia. D <sub>b</sub>	A <sub>a</sub> <sup>(6)</sup>	A <sub>b</sub> <sup>(7)</sup>				
mm in.	mm in.	mm in.	mm in.	mm in.	mm in.	mm in.	mm in.	mm in.	mm in.	mm in.				kg lbs.
29.007 1.1420	29.000 1.1417	-4.1 -0.16	3.5 0.14	77.0 3.03	83.0 3.27	2.0 0.08	114.0 4.49	107.0 4.21	1.5 0.05	2.2 0.09	77.2	23.0	0.1083	1.36 2.99
29.007 1.1420	24.237 0.9542	-4.1 -0.16	3.5 0.14	77.0 3.03	83.0 3.27	2.0 0.08	114.0 4.49	107.0 4.21	1.5 0.05	2.2 0.09	77.2	23.0	0.1083	1.31 2.88
30.162 1.1875	23.444 0.9230	-2.8 -0.11	3.5 0.14	79.0 3.11	85.0 3.35	0.8 0.03	113.0 4.45	107.0 4.21	2.2 0.08	1.1 0.05	84.2	25.9	0.1162	1.35 2.97
32.545 1.2813	26.195 1.0313	-6.4 -0.25	3.5 0.14	78.0 3.07	84.0 3.31	3.3 0.13	114.0 4.49	107.0 4.21	2.2 0.08	2.0 0.08	98.4	26.3	0.1153	1.46 3.20
32.545 1.2813	26.195 1.0313	-6.4 -0.25	3.5 0.14	78.0 3.07	84.0 3.31	0.5 0.02	114.0 4.49	109.0 4.29	2.2 0.08	2.0 0.08	98.4	26.3	0.1153	1.48 3.24
25.400 1.0000	19.050 0.7500	1.0 0.04	1.5 0.06	77.0 3.03	80.0 3.15	3.3 0.13	113.0 4.45	104.0 4.09	2.3 0.09	1.5 0.06	77.7	43.3	0.1170	1.16 2.57
29.007 1.1420	24.605 0.9687	-4.1 -0.16	3.5 0.14	77.0 3.03	83.0 3.27	3.3 0.13	115.0 4.53	109.0 4.29	1.5 0.05	2.2 0.09	77.2	23.0	0.1083	1.45 3.19
36.170 1.4240	28.575 1.1250	-8.1 -0.32	3.5 0.14	78.0 3.07	85.0 3.35	3.3 0.13	120.0 4.72	112.0 4.41	3.2 0.12	1.8 0.08	101.3	24.0	0.1167	1.90 4.20
36.170 1.4240	28.575 1.1250	-8.1 -0.32	0.8 0.03	78.0 3.07	79.0 3.11	3.3 0.13	120.0 4.72	112.0 4.41	3.2 0.12	1.8 0.08	101.3	24.0	0.1167	1.91 4.23
36.512 1.4375	26.988 1.0625	-3.8 -0.15	3.5 0.14	82.0 3.23	89.0 3.50	1.5 0.06	121.0 4.76	113.0 4.45	4.0 0.15	1.3 0.06	91.7	22.9	0.1252	1.90 4.19
36.512 1.4375	26.988 1.0625	-3.8 -0.15	3.5 0.14	82.0 3.23	89.0 3.50	3.3 0.13	121.0 4.76	111.0 4.37	4.0 0.15	1.3 0.06	91.7	22.9	0.1252	1.90 4.19
41.275 1.6250	31.750 1.2500	-11.2 -0.44	3.5 0.14	80.0 3.15	86.0 3.39	3.3 0.13	124.0 4.88	116.0 4.57	4.1 0.16	2.0 0.08	106.4	21.0	0.0814	2.27 5.00
41.275 1.6250	31.750 1.2500	-11.2 -0.44	3.5 0.14	80.0 3.15	86.0 3.39	3.3 0.13	125.0 4.92	118.0 4.65	4.1 0.16	2.0 0.08	106.4	21.0	0.0814	2.61 5.75
46.038 1.8125	36.512 1.4375	-8.6 -0.34	3.5 0.14	87.0 3.43	93.0 3.66	3.3 0.13	133.0 5.24	120.0 4.72	4.1 0.16	2.0 0.08	147.1	33.5	0.0993	3.35 7.40
33.338 1.3125	23.812 0.9375	12.4 0.49	4.0 0.16	86.1 3.38	95.0 3.74	3.3 0.13	139.0 5.47	122.0 4.80	7.1 0.28	4.6 0.18	71.5	21.8	0.0943	2.57 5.66
39.688 1.5625	25.400 1.0000	4.3 0.17	3.5 0.14	82.4 3.24	95.0 3.74	3.3 0.13	138.0 5.43	124.0 4.88	8.2 0.32	3.6 0.14	78.5	17.3	0.0927	2.87 6.33
41.275 1.6250	31.750 1.2500	-7.9 -0.31	3.5 0.14	82.0 3.23	88.0 3.46	3.3 0.13	139.0 5.47	131.0 5.16	4.5 0.17	2.1 0.08	136.6	27.3	0.0919	3.24 7.15

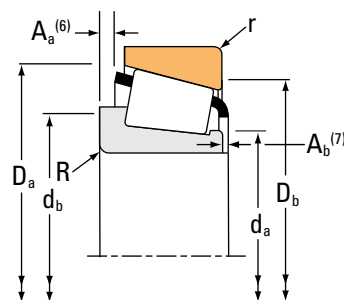
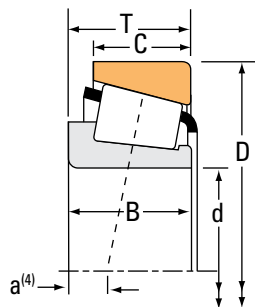
(4) Negative value indicates effective center inside cone (inner-ring) backface.  
 (5) These maximum fillet radii will be cleared by the bearing corners.  
 (6) Negative value indicates cage extends beyond cone (inner-ring) backface.  
 (7) Negative value indicates cage that does not extend beyond cone (inner-ring) front face.

Continued on next page.

# TAPERED ROLLER BEARINGS

## SINGLE-ROW • TYPE TS

### TYPE TS



Bearing Dimensions			Load Ratings							Part Number			
Bore d	O.D. D	Width T	Dynamic <sup>(1)</sup>		Factors <sup>(2)</sup>		Dynamic <sup>(3)</sup>		Factors <sup>(2)</sup>		Static C <sub>0</sub>	Inner	Outer
			C <sub>1</sub>	e	Y	C <sub>90</sub>	C <sub>a90</sub>	K	N	N			
mm in.	mm in.	mm in.	N lbf			N lbf	N lbf		N lbf				
69.850 2.7500	149.225 5.8750	53.975 2.1250	411000 92400	0.36	1.66	107000 24000	66000 14800	1.61	463000 104000		6454	6420	
69.850 2.7500	149.225 5.8750	53.975 2.1250	411000 92400	0.36	1.66	107000 24000	66000 14800	1.61	463000 104000		6484	6420	
69.850 2.7500	150.089 5.9090	44.450 1.7500	377000 84700	0.33	1.84	97600 21900	54400 12200	1.80	417000 93800		745A	742	
69.850 2.7500	150.089 5.9090	44.450 1.7500	318000 71400	0.33	1.84	82400 18500	45900 10300	1.80	417000 93800		744A	742	
69.850 2.7500	152.400 6.0000	41.275 1.6250	247000 55500	0.41	1.47	64000 14400	44800 10100	1.43	335000 75300		655	652	
69.850 2.7500	168.275 6.6250	53.975 2.1250	485000 109000	0.30	2.00	126000 28300	64400 14500	1.95	522000 117000		835	832	
69.914 2.7525	171.450 6.7500	49.212 1.9375	363000 81600	0.76	0.79	94100 21200	123000 27700	0.76	351000 78800		9382	9321	
69.952 2.7540	121.442 4.7812	24.608 0.9688	102000 23000	0.45	1.33	26500 5960	20500 4600	1.30	136000 30600		34274	34478	
69.987 2.7554	136.525 5.3750	46.038 1.8125	319000 71700	0.47	1.27	82700 18600	67000 15100	1.24	405000 91000		H715347	H715311	
69.987 2.7554	176.212 6.9375	54.770 2.1563	366000 82200	0.70	0.86	94800 21300	114000 25500	0.84	431000 96900		H916642	H916610	
70.000 2.7559	110.000 4.3307	21.000 0.8268	91600 20600	0.46	1.30	23700 5340	18700 4210	1.27	112000 25200		JP7049	JP7010	
70.000 2.7559	110.000 4.3307	26.000 1.0236	115000 25700	0.49	1.23	29700 6680	24800 5570	1.20	168000 37800		JLM813049	JLM813010	
70.000 2.7559	115.000 4.5276	29.000 1.1417	150000 33700	0.43	1.39	38900 8740	28600 6440	1.36	198000 44500		JM612949	JM612910	
70.000 2.7559	120.000 4.7244	29.002 1.1418	143000 32200	0.38	1.56	37200 8360	24500 5500	1.52	186000 41900		484	472A	
70.000 2.7559	121.442 4.7812	24.608 0.9688	102000 23000	0.45	1.33	26500 5960	20500 4600	1.30	136000 30600		34275	34478	
70.000 2.7559	123.825 4.8750	30.162 1.1875	143000 32200	0.38	1.56	37200 8360	24500 5500	1.52	186000 41900		484	472X	
70.000 2.7559	125.095 4.9250	24.000 0.9449	102000 23000	0.45	1.33	26500 5960	20500 4600	1.30	136000 30600		34275	34492	

<sup>(1)</sup>Based on 1 x 10<sup>6</sup> revolutions L<sub>10</sub> life, for the ISO life-calculation method.

<sup>(2)</sup>Consult your Timken engineer for instructions on use or review the Timken Engineering Manual on timken.com/catalogs.

<sup>(3)</sup>Based on 90 x 10<sup>6</sup> revolutions L<sub>10</sub> life, for The Timken Company life-calculation method. C<sub>90</sub> and C<sub>a90</sub> are radial and thrust values.

Bearing Dimensions											Geometry Factors			Bearing Weight
Width B	Width C	Eff. Ctr. a <sup>(4)</sup>	Shaft			Housing			Cage		G <sub>1</sub>	G <sub>2</sub>	C <sub>g</sub>	
			Max Shaft Fillet Radius R <sup>(5)</sup>	Backing Shoulder Dia. d <sub>a</sub>	Backing Shoulder Dia. d <sub>b</sub>	Max Housing Fillet Radius r <sup>(5)</sup>	Backing Shoulder Dia. D <sub>a</sub>	Backing Shoulder Dia. D <sub>b</sub>	A <sub>a</sub> <sup>(6)</sup>	A <sub>b</sub> <sup>(7)</sup>				
mm in.	mm in.	mm in.	mm in.	mm in.	mm in.	mm in.	mm in.	mm in.	mm in.	mm in.				kg lbs.
54.229 2.1350	44.450 1.7500	-15.0 -0.59	5.0 0.20	85.0 3.35	94.0 3.70	3.3 0.13	140.0 5.51	129.0 5.08	2.7 0.10	0.7 0.03	158.3	29.1	0.0931	4.54 10.01
54.229 2.1350	44.450 1.7500	-15.0 -0.59	6.4 0.25	85.0 3.35	97.0 3.82	3.3 0.13	140.0 5.51	129.0 5.08	2.7 0.10	0.7 0.03	158.3	29.1	0.0931	4.53 9.99
46.672 1.8375	36.512 1.4375	-11.9 -0.47	3.5 0.14	82.0 3.23	88.0 3.46	3.3 0.13	142.0 5.59	134.0 5.28	1.8 0.07	1.3 0.05	159.6	26.3	0.0898	3.93 8.64
46.672 1.8375	36.512 1.4375	-11.9 -0.47	5.0 0.20	82.0 3.23	91.0 3.58	3.3 0.13	142.0 5.59	134.0 5.28	1.8 0.07	1.3 0.05	159.6	26.3	0.0898	3.91 8.60
41.275 1.6250	31.750 1.2500	-7.9 -0.31	3.5 0.14	82.0 3.23	88.0 3.46	3.3 0.13	141.0 5.55	134.0 5.28	4.5 0.17	2.1 0.08	136.6	27.3	0.0919	3.59 7.94
56.363 2.2190	41.275 1.6250	-18.5 -0.73	3.5 0.14	84.0 3.31	91.0 3.58	3.3 0.13	155.0 6.10	149.0 5.87	5.2 0.20	1.6 0.07	197.9	34.8	0.0937	6.10 13.43
46.038 1.8125	31.750 1.2500	4.3 0.17	3.5 0.14	95.0 3.74	101.0 3.98	3.3 0.13	164.0 6.46	147.0 5.79	8.9 0.35	3.9 0.16	117.9	18.6	0.1053	5.37 11.83
23.012 0.9060	17.462 0.6875	1.5 0.06	2.0 0.08	78.0 3.07	81.0 3.19	2.0 0.08	116.0 4.57	110.0 4.33	2.6 0.10	2.1 0.09	69.3	27.0	0.1093	1.08 2.39
46.038 1.8125	36.512 1.4375	-8.6 -0.34	3.5 0.14	87.0 3.43	93.0 3.66	3.3 0.13	132.0 5.20	118.0 4.65	4.1 0.16	2.0 0.08	147.1	33.5	0.0993	3.17 6.98
53.183 2.0938	36.512 1.4375	-2.0 -0.08	3.3 0.13	95.0 3.74	103.0 4.06	3.3 0.13	164.0 6.46	147.0 5.79	8.6 0.34	3.4 0.14	132.9	18.7	0.1071	6.31 13.93
20.000 0.7874	15.500 0.6102	2.5 0.10	2.0 0.08	76.0 2.99	80.0 3.15	2.0 0.08	105.4 4.15	101.0 3.98	1.5 0.05	2.9 0.12	51.1	31.0	0.9950	0.67 1.49
25.000 0.9843	20.500 0.8071	0.3 0.01	1.0 0.04	77.0 3.03	78.0 3.07	2.5 0.10	105.0 4.13	98.0 3.86	1.7 0.06	2.8 0.11	73.5	26.3	0.1151	0.88 1.93
29.000 1.1417	23.000 0.9055	-2.5 -0.10	3.0 0.12	77.0 3.03	83.0 3.27	2.5 0.10	110.0 4.33	103.0 4.06	1.0 0.04	2.3 0.09	76.7	25.7	0.1122	1.12 2.49
29.007 1.1420	23.444 0.9230	-4.1 -0.16	2.0 0.08	77.0 3.03	80.0 3.15	3.3 0.13	114.0 4.49	106.0 4.17	1.5 0.05	2.2 0.09	77.2	23.0	0.1083	1.29 2.82
23.012 0.9060	17.462 0.6875	1.5 0.06	2.0 0.08	78.0 3.07	82.0 3.23	2.0 0.08	116.0 4.57	110.0 4.33	2.6 0.10	2.1 0.09	69.3	27.0	0.1093	1.08 2.39
29.007 1.1420	24.605 0.9687	-4.1 -0.16	2.0 0.08	77.0 3.03	80.0 3.15	3.3 0.13	115.0 4.53	109.0 4.29	1.5 0.05	2.2 0.09	77.2	23.0	0.1083	1.46 3.20
23.012 0.9060	16.670 0.6563	1.5 0.06	2.0 0.08	78.0 3.07	82.0 3.23	2.0 0.08	118.0 4.65	112.0 4.41	2.6 0.10	2.1 0.09	69.3	27.0	0.1093	1.16 2.55

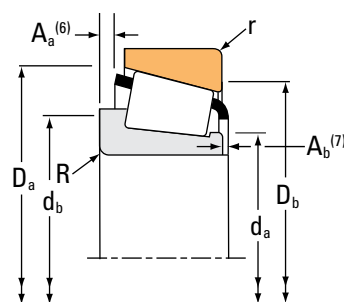
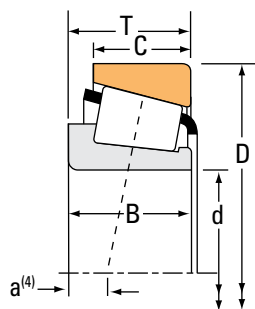
<sup>(4)</sup>Negative value indicates effective center inside cone (inner-ring) backface.  
<sup>(5)</sup>These maximum fillet radii will be cleared by the bearing corners.  
<sup>(6)</sup>Negative value indicates cage extends beyond cone (inner-ring) backface.  
<sup>(7)</sup>Negative value indicates cage that does not extend beyond cone (inner-ring) front face.

Continued on next page.

# TAPERED ROLLER BEARINGS

## SINGLE-ROW • TYPE TS

### TYPE TS



Bearing Dimensions			Load Ratings							Part Number			
Bore d	O.D. D	Width T	Dynamic <sup>(1)</sup>		Factors <sup>(2)</sup>		Dynamic <sup>(3)</sup>		Factors <sup>(2)</sup>		Static C <sub>0</sub>	Inner	Outer
			C <sub>1</sub>	e	Y	C <sub>90</sub>	C <sub>a90</sub>	K	N	N			
mm in.	mm in.	mm in.	N lbf			N lbf	N lbf		N lbf				
70.000 2.7559	130.000 5.1181	36.937 1.4542	196000 44100	0.36	1.65	50900 11400	31700 7130	1.61	262000 58900			570X	562X
70.000 2.7559	130.000 5.1181	43.000 1.6929	275000 61700	0.33	1.80	71200 16000	40600 9130	1.75	360000 80800			JF7049A	JF7010
70.000 2.7559	130.000 5.1181	43.000 1.6929	275000 61700	0.33	1.80	71200 16000	40600 9130	1.75	360000 80800			JF7049	JF7010
70.000 2.7559	140.000 5.5118	39.000 1.5354	204000 45800	0.87	0.69	52800 11900	78300 17600	0.67	257000 57800			JW7049	JW7010
70.000 2.7559	149.225 5.8750	53.975 2.1250	411000 92400	0.36	1.66	107000 24000	66000 14800	1.61	463000 104000			6459	6420
70.000 2.7559	150.000 5.9055	54.000 2.1260	411000 92400	0.36	1.66	107000 24000	66000 14800	1.61	463000 104000			6459	6424
70.637 2.7810	112.712 4.4375	25.400 1.0000	111000 24800	0.49	1.23	28600 6440	23900 5370	1.20	166000 37200			29680	29620
70.637 2.7810	112.712 4.4375	25.400 1.0000	111000 24800	0.49	1.23	28600 6440	23900 5370	1.20	166000 37200			29681	29620
71.437 2.8125	117.475 4.6250	30.162 1.1875	138000 31100	0.44	1.38	35900 8060	26800 6020	1.34	197000 44300			33281	33462
71.437 2.8125	117.475 4.6250	30.162 1.1875	138000 31100	0.44	1.38	35900 8060	26800 6020	1.34	197000 44300			33281	33461
71.437 2.8125	120.000 4.7244	29.794 1.1730	138000 31100	0.44	1.38	35900 8060	26800 6020	1.34	197000 44300			33281	33472
71.437 2.8125	120.000 4.7244	32.545 1.2813	179000 40200	0.36	1.67	46300 10400	28600 6420	1.62	249000 56000			47490	47420
71.437 2.8125	120.650 4.7500	32.545 1.2813	179000 40200	0.36	1.67	46300 10400	28600 6420	1.62	249000 56000			47490	47423
71.437 2.8125	127.000 5.0000	36.512 1.4375	196000 44100	0.36	1.65	50900 11400	31700 7130	1.61	262000 58900			567A	563
71.437 2.8125	127.000 5.0000	36.512 1.4375	196000 44100	0.36	1.65	50900 11400	31700 7130	1.61	262000 58900			567-S	563
71.437 2.8125	127.000 5.0000	36.512 1.4375	229000 51500	0.50	1.20	59400 13400	51100 11500	1.16	256000 57600			HM813849	HM813810
71.437 2.8125	127.000 5.0000	36.512 1.4375	229000 51500	0.50	1.20	59400 13400	51100 11500	1.16	256000 57600			HM813849	HM813811

<sup>(1)</sup>Based on 1 x 10<sup>6</sup> revolutions L<sub>10</sub> life, for the ISO life-calculation method.

<sup>(2)</sup>Consult your Timken engineer for instructions on use or review the Timken Engineering Manual on timken.com/catalogs.

<sup>(3)</sup>Based on 90 x 10<sup>6</sup> revolutions L<sub>10</sub> life, for The Timken Company life-calculation method. C<sub>90</sub> and C<sub>a90</sub> are radial and thrust values.

Bearing Dimensions											Geometry Factors			Bearing Weight
Width B	Width C	Eff. Ctr. a <sup>(4)</sup>	Shaft			Housing			Cage		G <sub>1</sub>	G <sub>2</sub>	C <sub>g</sub>	
			Max Shaft Fillet Radius R <sup>(5)</sup>	Backing Shoulder Dia. d <sub>a</sub> d <sub>b</sub>		Max Housing Fillet Radius r <sup>(5)</sup>	Backing Shoulder Dia. D <sub>a</sub> D <sub>b</sub>		A <sub>a</sub> <sup>(6)</sup>	A <sub>b</sub> <sup>(7)</sup>				
mm in.	mm in.	mm in.	mm in.	mm in.	mm in.	mm in.	mm in.	mm in.	mm in.	mm in.			kg lbs.	
36.170 1.4240	29.000 1.1417	-8.1 -0.32	3.0 0.12	78.0 3.07	84.0 3.31	3.0 0.12	121.0 4.76	114.0 4.49	3.2 0.12	1.8 0.08	101.3	24.0	0.1167	2.05 4.51
42.000 1.6535	35.000 1.3780	-12.4 -0.49	7.0 0.28	81.0 3.17	94.0 3.70	2.5 0.10	124.0 4.88	116.0 4.57	2.0 0.08	4.0 0.16	120.7	24.5	0.0828	2.46 5.40
42.000 1.6535	35.000 1.3780	-12.4 -0.49	3.0 0.12	81.0 3.17	86.0 3.39	2.5 0.10	124.0 4.88	116.0 4.57	2.0 0.08	4.0 0.16	120.7	24.5	0.8280	2.49 5.49
35.500 1.3976	27.000 1.0630	8.6 0.34	3.0 0.12	82.0 3.23	95.0 3.74	3.0 0.12	133.0 5.25	117.0 4.61	5.8 0.22	4.5 0.18	85.2	23.4	0.0984	2.64 5.79
54.229 2.1350	44.450 1.7500	-15.0 -0.59	3.0 0.12	85.0 3.35	90.0 3.54	3.3 0.13	140.0 5.51	129.0 5.08	2.7 0.10	0.7 0.03	158.3	29.1	0.0931	4.55 10.03
54.229 2.1350	45.000 1.7717	-15.0 -0.59	3.0 0.12	85.0 3.35	90.0 3.54	3.0 0.12	140.0 5.51	129.0 5.08	2.7 0.10	0.7 0.03	158.3	29.1	0.0931	4.63 10.21
25.400 1.0000	19.050 0.7500	1.0 0.04	1.3 0.05	78.0 3.07	80.0 3.15	3.3 0.13	109.0 4.29	101.0 3.98	2.3 0.09	1.5 0.06	77.7	43.3	0.1170	0.93 2.07
25.400 1.0000	19.050 0.7500	1.0 0.04	3.5 0.14	78.0 3.07	85.0 3.35	3.3 0.13	109.0 4.29	101.0 3.98	2.3 0.09	1.5 0.06	77.7	43.3	0.1170	0.93 2.06
30.162 1.1875	23.812 0.9375	-2.8 -0.11	3.5 0.14	80.0 3.15	87.0 3.43	3.3 0.13	112.0 4.41	104.0 4.09	2.2 0.08	1.1 0.05	84.2	25.9	0.1162	1.22 2.68
30.162 1.1875	23.812 0.9375	-2.8 -0.11	3.5 0.14	80.0 3.15	87.0 3.43	0.8 0.03	112.0 4.41	106.0 4.17	2.2 0.08	1.1 0.05	84.2	25.9	0.1162	1.23 2.71
30.162 1.1875	23.444 0.9230	-2.8 -0.11	3.5 0.14	80.0 3.15	87.0 3.43	0.8 0.03	113.0 4.45	107.0 4.21	2.2 0.08	1.1 0.05	84.2	25.9	0.1162	1.31 2.88
32.545 1.2813	26.195 1.0313	-6.4 -0.25	3.5 0.14	79.0 3.11	86.0 3.39	3.3 0.13	114.0 4.49	107.0 4.21	2.2 0.08	2.0 0.08	98.4	26.3	0.1153	1.41 3.10
32.545 1.2813	26.195 1.0313	-6.4 -0.25	3.5 0.14	79.0 3.11	86.0 3.39	0.8 0.03	115.0 4.53	109.0 4.29	2.2 0.08	2.0 0.08	98.4	26.3	0.1153	1.45 3.19
36.170 1.4240	28.575 1.1250	-8.1 -0.32	3.5 0.14	80.0 3.15	86.0 3.39	3.3 0.13	120.0 4.72	112.0 4.41	3.2 0.12	1.8 0.08	101.3	24.0	0.1167	1.85 4.09
36.170 1.4240	28.575 1.1250	-8.1 -0.32	6.4 0.25	80.0 3.15	92.0 3.62	3.3 0.13	120.0 4.72	112.0 4.41	3.2 0.12	1.8 0.08	101.3	24.0	0.1167	1.82 4.03
36.512 1.4375	26.988 1.0625	-3.8 -0.15	3.5 0.14	82.0 3.23	91.0 3.58	3.3 0.13	121.0 4.76	111.0 4.37	4.0 0.15	1.3 0.06	91.7	22.9	0.1252	1.84 4.08
36.512 1.4375	26.988 1.0625	-3.8 -0.15	3.5 0.14	82.0 3.23	91.0 3.58	1.5 0.06	121.0 4.76	113.0 4.45	4.0 0.15	1.3 0.06	91.7	22.9	0.1252	1.84 4.08

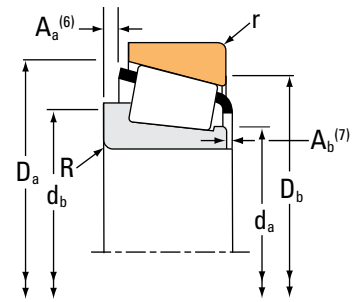
<sup>(4)</sup>Negative value indicates effective center inside cone (inner-ring) backface.  
<sup>(5)</sup>These maximum fillet radii will be cleared by the bearing corners.  
<sup>(6)</sup>Negative value indicates cage extends beyond cone (inner-ring) backface.  
<sup>(7)</sup>Negative value indicates cage that does not extend beyond cone (inner-ring) front face.

Continued on next page.

# TAPERED ROLLER BEARINGS

## SINGLE-ROW • TYPE TS

### TYPE TS



Bearing Dimensions			Load Ratings							Part Number		
Bore d	O.D. D	Width T	Dynamic <sup>(1)</sup>		Factors <sup>(2)</sup>		Dynamic <sup>(3)</sup>		Factors <sup>(2)</sup>	Static	Inner	Outer
			C <sub>1</sub>	e	Y	C <sub>90</sub>	C <sub>a90</sub>	K	C <sub>0</sub>			
mm in.	mm in.	mm in.	N lbf			N lbf	N lbf			N lbf		
71.437 2.8125	130.175 5.1250	41.275 1.6250	276000 62100	0.36	1.66	71600 16100	44400 9980	1.61		298000 67000	645	633
71.437 2.8125	130.175 5.1250	41.275 1.6250	276000 62100	0.36	1.66	71600 16100	44400 9980	1.61		298000 67000	644	633
71.437 2.8125	133.350 5.2500	33.338 1.3125	214000 48100	0.40	1.48	55500 12500	38400 8640	1.44		262000 58900	47675	47620
71.437 2.8125	136.525 5.3750	30.162 1.1875	154000 34700	0.44	1.35	40000 9000	30500 6850	1.31		216000 48600	495-S	493
71.437 2.8125	136.525 5.3750	41.275 1.6250	276000 62100	0.36	1.66	71600 16100	44400 9980	1.61		298000 67000	645	632
71.437 2.8125	136.525 5.3750	41.275 1.6250	276000 62100	0.36	1.66	71600 16100	44400 9980	1.61		298000 67000	644	632
71.437 2.8125	136.525 5.3750	41.275 1.6250	233000 52400	0.36	1.66	60400 13600	37400 8420	1.61		298000 67000	645X	632
71.437 2.8125	136.525 5.3750	41.275 1.6250	323000 72600	0.36	1.67	83700 18800	51600 11600	1.62		335000 75400	H414249	H414210
71.437 2.8125	136.525 5.3750	46.038 1.8125	319000 71700	0.47	1.27	82700 18600	67000 15100	1.24		405000 91000	H715345	H715311
71.437 2.8125	139.700 5.5000	46.038 1.8125	319000 71700	0.47	1.27	82700 18600	67000 15100	1.24		405000 91000	H715345	H715310
73.025 2.8750	112.712 4.4375	25.400 1.0000	111000 24800	0.49	1.23	28600 6440	23900 5370	1.20		166000 37200	29685	29620
73.025 2.8750	117.475 4.6250	25.400 1.0000	118000 26500	0.51	1.18	30600 6870	26700 5990	1.15		183000 41200	LM814845	LM814810
73.025 2.8750	117.475 4.6250	30.162 1.1875	138000 31100	0.44	1.38	35900 8060	26800 6020	1.34		197000 44300	33287	33462
73.025 2.8750	120.000 4.7244	29.794 1.1730	138000 31100	0.44	1.38	35900 8060	26800 6020	1.34		197000 44300	33287	33472
73.025 2.8750	120.000 4.7244	29.794 1.1730	138000 31100	0.44	1.38	35900 8060	26800 6020	1.34		197000 44300	33287A	33472
73.025 2.8750	125.412 4.9375	25.400 1.0000	117000 26300	0.42	1.44	30400 6830	21600 4860	1.40		178000 39900	27680	27620
73.025 2.8750	127.000 5.0000	30.162 1.1875	161000 36200	0.42	1.43	41800 9390	29900 6730	1.39		222000 49800	42683	42620

<sup>(1)</sup>Based on 1 x 10<sup>6</sup> revolutions L<sub>10</sub> life, for the ISO life-calculation method.

<sup>(2)</sup>Consult your Timken engineer for instructions on use or review the Timken Engineering Manual on timken.com/catalogs.

<sup>(3)</sup>Based on 90 x 10<sup>6</sup> revolutions L<sub>10</sub> life, for The Timken Company life-calculation method. C<sub>90</sub> and C<sub>a90</sub> are radial and thrust values.

Bearing Dimensions											Geometry Factors			Bearing Weight
Width B	Width C	Eff. Ctr. a <sup>(4)</sup>	Shaft			Housing			Cage		G <sub>1</sub>	G <sub>2</sub>	C <sub>g</sub>	
			Max Shaft Fillet Radius R <sup>(5)</sup>	Backing Shoulder Dia. d <sub>a</sub>	Shoulder Dia. d <sub>b</sub>	Max Housing Fillet Radius r <sup>(5)</sup>	Backing Shoulder Dia. D <sub>a</sub>	Shoulder Dia. D <sub>b</sub>	A <sub>a</sub> <sup>(6)</sup>	A <sub>b</sub> <sup>(7)</sup>				
mm in.	mm in.	mm in.	mm in.	mm in.	mm in.	mm in.	mm in.	mm in.	mm in.	mm in.				kg lbs.
41.275 1.6250	31.750 1.2500	-11.2 -0.44	6.4 0.25	81.0 3.19	93.0 3.66	3.3 0.13	124.0 4.88	116.0 4.57	4.1 0.16	2.0 0.08	106.4	21.0	0.0814	2.19 4.81
41.275 1.6250	31.750 1.2500	-11.2 -0.44	3.5 0.14	81.0 3.19	87.0 3.43	3.3 0.13	124.0 4.88	116.0 4.57	4.1 0.16	2.0 0.08	106.4	21.0	0.0814	2.22 4.89
33.338 1.3125	26.195 1.0313	-4.3 -0.17	3.5 0.14	82.0 3.23	88.0 3.46	3.3 0.13	128.0 5.04	119.0 4.69	2.3 0.09	2.4 0.10	119.4	29.2	0.1273	2.06 4.52
29.769 1.1720	22.225 0.8750	-0.8 -0.03	3.5 0.14	82.0 3.23	88.0 3.46	3.3 0.13	130.0 5.12	122.0 4.80	2.5 0.09	2.2 0.09	104.6	29.3	0.1252	1.93 4.25
41.275 1.6250	31.750 1.2500	-11.2 -0.44	6.4 0.25	81.0 3.19	93.0 3.66	3.3 0.13	125.0 4.92	118.0 4.65	4.1 0.16	2.0 0.08	106.4	21.0	0.0814	2.53 5.57
41.275 1.6250	31.750 1.2500	-11.2 -0.44	3.5 0.14	81.0 3.19	87.0 3.43	3.3 0.13	125.0 4.92	118.0 4.65	4.1 0.16	2.0 0.08	106.4	21.0	0.0814	2.56 5.65
41.275 1.6250	31.750 1.2500	-11.2 -0.44	6.4 0.25	82.7 3.25	93.0 3.66	3.3 0.13	125.0 4.92	118.0 4.65	4.1 0.16	2.0 0.08	106.4	21.0	0.0814	2.52 5.56
41.275 1.6250	31.750 1.2500	-10.9 -0.43	3.5 0.14	83.3 3.27	89.0 3.50	3.3 0.13	129.0 5.08	121.0 4.76	3.7 0.14	3.1 0.12	112.8	22.9	0.0827	2.54 5.62
46.038 1.8125	36.512 1.4375	-8.6 -0.34	3.5 0.14	88.0 3.46	94.0 3.70	3.3 0.13	132.0 5.20	118.0 4.65	4.1 0.16	2.0 0.08	147.1	33.5	0.0993	3.11 6.86
46.038 1.8125	36.512 1.4375	-8.6 -0.34	3.5 0.14	88.0 3.46	94.0 3.70	3.3 0.13	133.0 5.24	120.0 4.72	4.1 0.16	2.0 0.08	147.1	33.5	0.0993	3.29 7.26
25.400 1.0000	19.050 0.7500	1.0 0.04	3.5 0.14	80.0 3.15	86.0 3.39	3.3 0.13	109.0 4.29	101.0 3.98	2.3 0.09	1.5 0.06	77.7	43.3	0.1170	0.88 1.95
25.400 1.0000	19.050 0.7500	2.3 0.09	3.5 0.14	81.0 3.19	87.0 3.43	3.3 0.13	113.0 4.45	105.0 4.13	2.4 0.09	1.5 0.06	88.6	36.6	0.1239	1.02 2.25
30.162 1.1875	23.812 0.9375	-2.8 -0.11	3.5 0.14	81.0 3.19	88.0 3.46	3.3 0.13	112.0 4.41	104.0 4.09	2.2 0.08	1.1 0.05	84.2	25.9	0.1162	1.18 2.59
30.162 1.1875	23.444 0.9230	-2.8 -0.11	3.5 0.14	81.0 3.19	88.0 3.46	0.8 0.03	113.0 4.45	107.0 4.21	2.2 0.08	1.1 0.05	84.2	25.9	0.1162	1.27 2.79
30.162 1.1875	23.444 0.9230	-2.8 -0.11	0.3 0.01	81.0 3.19	82.0 3.23	0.8 0.03	113.0 4.45	107.0 4.21	2.2 0.08	1.1 0.05	84.2	25.9	0.1162	1.27 2.80
25.400 1.0000	19.845 0.7813	0.5 0.02	3.5 0.14	82.0 3.23	88.0 3.46	1.5 0.06	120.0 4.72	115.0 4.53	1.5 0.06	1.7 0.07	98.2	41.8	0.1198	1.29 2.85
31.000 1.2205	22.225 0.8750	-2.8 -0.11	3.5 0.14	81.0 3.19	88.0 3.46	3.3 0.13	121.0 4.76	114.0 4.49	3.3 0.13	0.9 0.04	96.2	28.6	0.1197	1.51 3.31

<sup>(4)</sup>Negative value indicates effective center inside cone (inner-ring) backface.

<sup>(5)</sup>These maximum fillet radii will be cleared by the bearing corners.

<sup>(6)</sup>Negative value indicates cage extends beyond cone (inner-ring) backface.

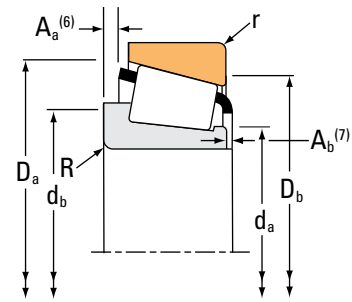
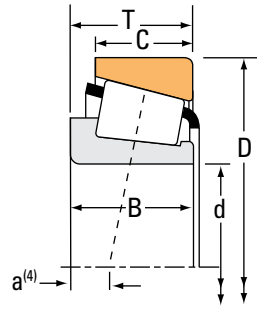
<sup>(7)</sup>Negative value indicates cage that does not extend beyond cone (inner-ring) front face.

Continued on next page.

# TAPERED ROLLER BEARINGS

## SINGLE-ROW • TYPE TS

### TYPE TS



Bearing Dimensions			Load Ratings							Part Number		
Bore d	O.D. D	Width T	Dynamic <sup>(1)</sup>		Factors <sup>(2)</sup>		Dynamic <sup>(3)</sup>		Factors <sup>(2)</sup>	Static	Inner	Outer
			C <sub>1</sub>	e	Y	C <sub>90</sub>	C <sub>a90</sub>	K	C <sub>0</sub>			
mm in.	mm in.	mm in.	N lbf			N lbf	N lbf			N lbf		
73.025 2.8750	127.000 5.0000	36.512 1.4375	196000 44100	0.36	1.65	50900 11400	31700 7130	1.61		262000 58900	567	563
73.025 2.8750	127.000 5.0000	36.512 1.4375	196000 44100	0.36	1.65	50900 11400	31700 7130	1.61		262000 58900	567X	563
73.025 2.8750	127.000 5.0000	36.512 1.4375	196000 44100	0.36	1.65	50900 11400	31700 7130	1.61		262000 58900	567	563X
73.025 2.8750	127.000 5.0000	36.512 1.4375	196000 44100	0.36	1.65	50900 11400	31700 7130	1.61		262000 58900	567X	563X
73.025 2.8750	130.000 5.1181	36.937 1.4542	196000 44100	0.36	1.65	50900 11400	31700 7130	1.61		262000 58900	567X	562X
73.025 2.8750	130.048 5.1200	36.512 1.4375	196000 44100	0.36	1.65	50900 11400	31700 7130	1.61		262000 58900	567	562
73.025 2.8750	139.992 5.5115	36.512 1.4375	207000 46500	0.40	1.49	53600 12100	37100 8330	1.45		291000 65400	576	572
73.025 2.8750	146.050 5.7500	41.275 1.6250	247000 55500	0.41	1.47	64000 14400	44800 10100	1.43		335000 75300	657	653
73.025 2.8750	149.225 5.8750	53.975 2.1250	411000 92400	0.36	1.66	107000 24000	66000 14800	1.61		463000 104000	6460	6420
73.025 2.8750	149.225 5.8750	53.975 2.1250	411000 92400	0.36	1.66	107000 24000	66000 14800	1.61		463000 104000	6460	6420A
73.025 2.8750	150.089 5.9090	44.450 1.7500	377000 84700	0.33	1.84	97600 21900	54400 12200	1.80		417000 93800	744	742
73.025 2.8750	152.400 6.0000	41.275 1.6250	247000 55500	0.41	1.47	64000 14400	44800 10100	1.43		335000 75300	657	652
73.817 2.9062	112.712 4.4375	25.400 1.0000	111000 24800	0.49	1.23	28600 6440	23900 5370	1.20		166000 37200	29688	29620
73.817 2.9062	127.000 5.0000	36.512 1.4375	196000 44100	0.36	1.65	50900 11400	31700 7130	1.61		262000 58900	568	563
74.612 2.9375	139.992 5.5115	36.512 1.4375	207000 46500	0.40	1.49	53600 12100	37100 8330	1.45		291000 65400	577	572
74.612 2.9375	152.400 6.0000	41.275 1.6250	247000 55500	0.41	1.47	64000 14400	44800 10100	1.43		335000 75300	658	652
74.976 2.9518	127.000 5.0000	26.988 1.0625	102000 23000	0.45	1.33	26500 5960	20500 4600	1.30		136000 30600	34294	34500

<sup>(1)</sup>Based on 1 x 10<sup>6</sup> revolutions L<sub>10</sub> life, for the ISO life-calculation method.

<sup>(2)</sup>Consult your Timken engineer for instructions on use or review the Timken Engineering Manual on timken.com/catalogs.

<sup>(3)</sup>Based on 90 x 10<sup>6</sup> revolutions L<sub>10</sub> life, for The Timken Company life-calculation method. C<sub>90</sub> and C<sub>a90</sub> are radial and thrust values.



Bearing Dimensions											Geometry Factors			Bearing Weight
Width B	Width C	Eff. Ctr. a <sup>(4)</sup>	Shaft			Housing			Cage		G <sub>1</sub>	G <sub>2</sub>	C <sub>g</sub>	
			Max Shaft Fillet Radius R <sup>(5)</sup>	Backing Shoulder Dia. d <sub>a</sub>	Backing Shoulder Dia. d <sub>b</sub>	Max Housing Fillet Radius r <sup>(5)</sup>	Backing Shoulder Dia. D <sub>a</sub>	Backing Shoulder Dia. D <sub>b</sub>	A <sub>a</sub> <sup>(6)</sup>	A <sub>b</sub> <sup>(7)</sup>				
mm in.	mm in.	mm in.	mm in.	mm in.	mm in.	mm in.	mm in.	mm in.	mm in.	mm in.				kg lbs.
36.170 1.4240	28.575 1.1250	-8.1 -0.32	3.5 0.14	81.0 3.19	88.0 3.46	3.3 0.13	120.0 4.72	112.0 4.41	3.2 0.12	1.8 0.08	101.3	24.0	0.1167	1.80 3.98
36.170 1.4240	28.575 1.1250	-8.1 -0.32	4.8 0.19	81.0 3.19	90.0 3.54	3.3 0.13	120.0 4.72	112.0 4.41	3.2 0.12	1.8 0.08	101.3	24.0	0.1167	1.80 3.99
36.170 1.4240	28.575 1.1250	-8.1 -0.32	3.5 0.14	81.0 3.19	88.0 3.46	0.8 0.03	120.0 4.72	114.0 4.49	3.2 0.12	1.8 0.08	101.3	24.0	0.1167	1.81 3.99
36.170 1.4240	28.575 1.1250	-8.1 -0.32	4.8 0.19	81.0 3.19	90.0 3.54	0.8 0.03	120.0 4.72	114.0 4.49	3.2 0.12	1.8 0.08	101.3	24.0	0.1167	1.81 4.00
36.170 1.4240	29.000 1.1417	-8.1 -0.32	4.8 0.19	81.0 3.19	90.0 3.54	3.0 0.12	121.0 4.76	114.0 4.49	3.2 0.12	1.8 0.08	101.3	24.0	0.1167	1.95 4.30
36.170 1.4240	28.575 1.1250	-8.1 -0.32	3.5 0.14	81.0 3.19	88.0 3.46	0.8 0.03	121.0 4.76	116.0 4.57	3.2 0.12	1.8 0.08	101.3	24.0	0.1167	1.95 4.29
36.098 1.4212	28.575 1.1250	-5.3 -0.21	3.5 0.14	83.0 3.27	90.0 3.54	3.3 0.13	133.0 5.24	125.0 4.92	3.4 0.13	1.9 0.08	125.7	32.0	0.1295	2.46 5.43
41.275 1.6250	31.750 1.2500	-7.9 -0.31	3.5 0.14	85.0 3.35	91.0 3.58	3.3 0.13	139.0 5.47	131.0 5.16	4.5 0.17	2.1 0.08	136.6	27.3	0.0919	3.13 6.89
54.229 2.1350	44.450 1.7500	-15.0 -0.59	3.5 0.14	87.0 3.43	93.0 3.66	3.3 0.13	140.0 5.51	129.0 5.08	2.7 0.10	0.7 0.03	158.3	29.1	0.0931	4.40 9.71
54.229 2.1350	44.450 1.7500	-15.0 -0.59	3.5 0.14	87.0 3.43	93.0 3.66	0.8 0.03	140.0 5.51	131.0 5.16	2.7 0.10	0.7 0.03	158.3	29.1	0.0931	4.42 9.75
46.672 1.8375	36.512 1.4375	-11.9 -0.47	3.5 0.14	85.0 3.35	91.0 3.58	3.3 0.13	142.0 5.59	134.0 5.28	1.8 0.07	1.3 0.05	159.6	26.3	0.0898	3.79 8.34
41.275 1.6250	31.750 1.2500	-7.9 -0.31	3.5 0.14	85.0 3.35	91.0 3.58	3.3 0.13	141.0 5.55	134.0 5.28	4.5 0.17	2.1 0.08	136.6	27.3	0.0919	3.48 7.68
25.400 1.0000	19.050 0.7500	1.0 0.04	1.5 0.06	80.0 3.15	83.0 3.27	3.3 0.13	109.0 4.29	101.0 3.98	2.3 0.09	1.5 0.06	77.7	43.3	0.1170	0.86 1.91
36.170 1.4240	28.575 1.1250	-8.1 -0.32	0.8 0.03	82.0 3.23	83.0 3.27	3.3 0.13	120.0 4.72	112.0 4.41	3.2 0.12	1.8 0.08	101.3	24.0	0.1167	1.78 3.95
36.098 1.4212	28.575 1.1250	-5.3 -0.21	3.5 0.14	85.0 3.35	91.0 3.58	3.3 0.13	133.0 5.24	125.0 4.92	3.4 0.13	1.9 0.08	125.7	32.0	0.1295	2.41 5.32
41.275 1.6250	31.750 1.2500	-7.9 -0.31	3.5 0.14	86.0 3.39	92.0 3.62	3.3 0.13	141.0 5.55	134.0 5.28	4.5 0.17	2.1 0.08	136.6	27.3	0.0919	3.42 7.55
23.012 0.9060	19.842 0.7812	1.5 0.06	2.0 0.08	82.0 3.23	85.0 3.35	3.3 0.13	118.0 4.65	112.0 4.41	2.6 0.10	2.1 0.09	69.3	27.0	0.1093	1.19 2.64

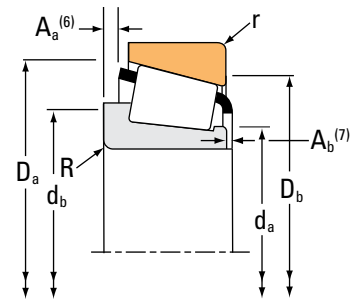
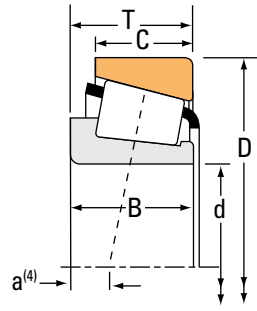
<sup>(4)</sup>Negative value indicates effective center inside cone (inner-ring) backface.  
<sup>(5)</sup>These maximum fillet radii will be cleared by the bearing corners.  
<sup>(6)</sup>Negative value indicates cage extends beyond cone (inner-ring) backface.  
<sup>(7)</sup>Negative value indicates cage that does not extend beyond cone (inner-ring) front face.

Continued on next page.

# TAPERED ROLLER BEARINGS

## SINGLE-ROW • TYPE TS

### TYPE TS



Bearing Dimensions			Load Ratings							Part Number			
Bore d	O.D. D	Width T	Dynamic <sup>(1)</sup>		Factors <sup>(2)</sup>		Dynamic <sup>(3)</sup>		Factors <sup>(2)</sup>		Static C <sub>0</sub>	Inner	Outer
			C <sub>1</sub>	e	Y	C <sub>90</sub>	C <sub>a90</sub>	K	N	N			
mm in.	mm in.	mm in.	N lbf			N lbf	N lbf		N lbf				
74.987 2.9523	129.975 5.1171	33.249 1.3090	161000 36200	0.42	1.43	41800 9390	29900 6730	1.39	222000 49800		42686	42624	
75.000 2.9528	115.000 4.5276	25.000 0.9843	118000 26600	0.46	1.31	30700 6900	24100 5420	1.27	167000 37500		JLM714149	JLM714110	
75.000 2.9528	120.000 4.7244	31.000 1.2205	159000 35800	0.44	1.35	41300 9290	31400 7070	1.31	229000 51500		JM714249	JM714210	
75.000 2.9528	120.000 4.7244	31.000 1.2205	159000 35800	0.44	1.35	41300 9290	31400 7070	1.31	229000 51500		JM714249A	JM714210	
75.000 2.9528	145.000 5.7087	51.000 2.0079	347000 78000	0.36	1.66	89900 20200	55700 12500	1.61	463000 104000		JH415647	JH415610	
75.987 2.9916	131.975 5.1959	39.000 1.5354	240000 53900	0.33	1.80	62200 14000	35400 7960	1.76	324000 72800		HM215249	HM215210	
76.200 3.0000	105.570 4.1563	13.495 0.5313	41000 9210	0.47	1.27	10600 2390	8600 1930	1.24	61000 13700		LL714649	LL714610	
76.200 3.0000	109.538 4.3125	19.050 0.7500	69200 15600	0.50	1.20	17900 4030	15400 3470	1.16	120000 27000		L814749	L814710	
76.200 3.0000	121.442 4.7812	24.608 0.9688	102000 23000	0.45	1.33	26500 5960	20500 4600	1.30	136000 30600		34300	34478	
76.200 3.0000	121.442 4.7812	24.608 0.9688	102000 23000	0.45	1.33	26500 5960	20500 4600	1.30	136000 30600		34301	34478	
76.200 3.0000	125.412 4.9375	25.400 1.0000	117000 26300	0.42	1.44	30400 6830	21600 4860	1.40	178000 39900		27684	27620	
76.200 3.0000	125.412 4.9375	25.400 1.0000	111000 24900	0.42	1.44	28700 6450	20400 4590	1.40	178000 39900		27684A	27620	
76.200 3.0000	127.000 5.0000	26.988 1.0625	102000 23000	0.45	1.33	26500 5960	20500 4600	1.30	136000 30600		34301	34500	
76.200 3.0000	127.000 5.0000	26.988 1.0625	102000 23000	0.45	1.33	26500 5960	20500 4600	1.30	136000 30600		34300	34500	
76.200 3.0000	127.000 5.0000	30.162 1.1875	161000 36200	0.42	1.43	41800 9390	29900 6730	1.39	222000 49800		42687	42620	
76.200 3.0000	127.000 5.0000	30.162 1.1875	161000 36200	0.42	1.43	41800 9390	29900 6730	1.39	222000 49800		42688	42620	
76.200 3.0000	133.350 5.2500	30.162 1.1875	154000 34700	0.44	1.35	40000 9000	30500 6850	1.31	216000 48600		495A	492A	

<sup>(1)</sup>Based on 1 x 10<sup>6</sup> revolutions L<sub>10</sub> life, for the ISO life-calculation method.

<sup>(2)</sup>Consult your Timken engineer for instructions on use or review the Timken Engineering Manual on timken.com/catalogs.

<sup>(3)</sup>Based on 90 x 10<sup>6</sup> revolutions L<sub>10</sub> life, for The Timken Company life-calculation method. C<sub>90</sub> and C<sub>a90</sub> are radial and thrust values.

Bearing Dimensions											Geometry Factors			Bearing Weight
Width B	Width C	Eff. Ctr. a <sup>(4)</sup>	Shaft			Housing			Cage		G <sub>1</sub>	G <sub>2</sub>	C <sub>g</sub>	
			Max Shaft Fillet Radius R <sup>(5)</sup>	Backing Shoulder Dia. d <sub>a</sub>	Backing Shoulder Dia. d <sub>b</sub>	Max Housing Fillet Radius r <sup>(5)</sup>	Backing Shoulder Dia. D <sub>a</sub>	Backing Shoulder Dia. D <sub>b</sub>	A <sub>a</sub> <sup>(6)</sup>	A <sub>b</sub> <sup>(7)</sup>				
mm in.	mm in.	mm in.	mm in.	mm in.	mm in.	mm in.	mm in.	mm in.	mm in.	mm in.				kg lbs.
31.000 1.2205	27.000 1.0630	-2.8 -0.11	6.4 0.25	83.0 3.27	94.0 3.70	2.3 0.09	123.0 4.84	115.0 4.53	3.3 0.13	0.9 0.04	96.2	28.6	0.1197	1.66 3.66
25.000 0.9843	19.000 0.7480	0.5 0.02	3.0 0.12	82.0 3.23	88.0 3.46	2.5 0.10	110.5 4.35	104.0 4.09	2.0 0.08	2.1 0.09	76.3	33.7	0.1140	0.88 1.93
29.500 1.1614	25.000 0.9843	-2.0 -0.08	3.0 0.12	82.9 3.26	88.0 3.46	2.5 0.10	115.0 4.53	108.0 4.25	2.1 0.08	2.7 0.11	95.0	32.8	0.1218	1.27 2.81
29.500 1.1614	25.000 0.9843	-2.0 -0.08	6.0 0.24	83.0 3.27	94.0 3.70	2.5 0.10	115.0 4.53	108.0 4.25	2.1 0.08	2.7 0.11	95.0	32.8	0.1218	1.23 2.72
51.000 2.0079	42.000 1.6535	-14.2 -0.56	3.0 0.12	89.0 3.50	94.0 3.70	2.5 0.10	139.0 5.47	129.0 5.08	2.0 0.07	3.2 0.13	158.3	26.4	0.0931	3.81 8.42
39.000 1.5354	32.000 1.2598	-9.7 -0.38	7.0 0.28	85.0 3.35	98.0 3.86	3.5 0.14	126.0 4.96	118.0 4.65	1.2 0.04	2.8 0.11	125.7	30.2	0.0837	2.11 4.65
13.495 0.5313	9.525 0.3750	6.6 0.26	1.5 0.06	81.0 3.19	83.0 3.27	1.5 0.06	102.0 4.02	99.0 3.90	0.8 0.03	1.2 0.05	45.7	64.3	0.0956	0.32 0.71
19.050 0.7500	15.083 0.5938	5.1 0.20	1.5 0.06	82.0 3.23	84.0 3.31	1.5 0.06	105.0 4.13	100.0 3.94	0.8 0.03	1.2 0.05	76.0	58.3	0.1164	0.58 1.28
23.012 0.9060	17.462 0.6875	1.5 0.06	2.0 0.08	83.0 3.27	86.0 3.39	2.0 0.08	116.0 4.57	110.0 4.33	2.6 0.10	2.1 0.09	69.3	27.0	0.1093	0.95 2.12
23.012 0.9060	17.462 0.6875	1.5 0.06	3.5 0.14	83.0 3.27	89.0 3.50	2.0 0.08	116.0 4.57	110.0 4.33	2.6 0.10	2.1 0.09	69.3	27.0	0.1093	0.94 2.09
25.400 1.0000	19.845 0.7813	0.5 0.02	3.5 0.14	84.0 3.31	91.0 3.58	1.5 0.06	120.0 4.72	115.0 4.53	1.5 0.06	1.7 0.07	98.2	41.8	0.1198	1.22 2.68
25.400 1.0000	19.845 0.7813	0.5 0.02	0.8 0.03	84.0 3.31	85.0 3.35	1.5 0.06	120.0 4.72	115.0 4.53	1.5 0.06	1.7 0.07	98.2	41.8	0.1198	1.23 2.71
23.012 0.9060	19.842 0.7812	1.5 0.06	3.5 0.14	83.0 3.27	89.0 3.50	3.3 0.13	118.0 4.65	112.0 4.41	2.6 0.10	2.1 0.09	69.3	27.0	0.1093	1.16 2.56
23.012 0.9060	19.842 0.7812	1.5 0.06	2.0 0.08	83.0 3.27	86.0 3.39	3.3 0.13	118.0 4.65	112.0 4.41	2.6 0.10	2.1 0.09	69.3	27.0	0.1093	1.17 2.59
31.000 1.2205	22.225 0.8750	-2.8 -0.11	3.5 0.14	84.0 3.31	90.0 3.54	3.3 0.13	121.0 4.76	114.0 4.49	3.3 0.13	0.9 0.04	96.2	28.6	0.1197	1.42 3.13
31.000 1.2205	22.225 0.8750	-2.8 -0.11	6.4 0.25	84.0 3.31	96.0 3.78	3.3 0.13	121.0 4.76	114.0 4.49	3.3 0.13	0.9 0.04	96.2	28.6	0.1197	1.39 3.05
29.769 1.1720	22.225 0.8750	-0.8 -0.03	3.5 0.14	86.0 3.39	92.0 3.62	3.3 0.13	128.0 5.04	120.0 4.72	2.5 0.09	2.2 0.09	104.6	29.3	0.1252	1.68 3.70

<sup>(4)</sup>Negative value indicates effective center inside cone (inner-ring) backface.

<sup>(5)</sup>These maximum fillet radii will be cleared by the bearing corners.

<sup>(6)</sup>Negative value indicates cage extends beyond cone (inner-ring) backface.

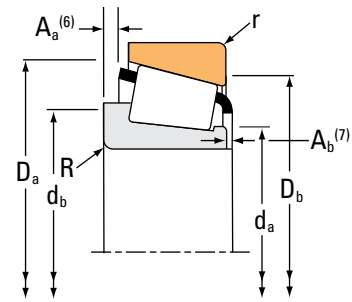
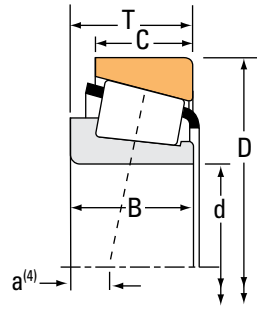
<sup>(7)</sup>Negative value indicates cage that does not extend beyond cone (inner-ring) front face.

Continued on next page.

# TAPERED ROLLER BEARINGS

## SINGLE-ROW • TYPE TS

### TYPE TS



Bearing Dimensions			Load Ratings							Part Number			
Bore d	O.D. D	Width T	Dynamic <sup>(1)</sup>		Factors <sup>(2)</sup>		Dynamic <sup>(3)</sup>		Factors <sup>(2)</sup>		Static C <sub>0</sub>	Inner	Outer
			C <sub>1</sub>	e	Y	C <sub>90</sub>	C <sub>a90</sub>	K	N	N			
mm in.	mm in.	mm in.	N lbf			N lbf	N lbf		N lbf				
76.200 3.0000	133.350 5.2500	33.338 1.3125	214000 48100	0.40	1.48	55500 12500	38400 8640	1.44	262000 58900			47679	47620
76.200 3.0000	133.350 5.2500	33.338 1.3125	214000 48100	0.40	1.48	55500 12500	38400 8640	1.44	262000 58900			47680	47620
76.200 3.0000	133.350 5.2500	33.338 1.3125	214000 48100	0.40	1.48	55500 12500	38400 8640	1.44	262000 58900			47678	47620
76.200 3.0000	133.350 5.2500	79.375 1.3125	214000 48100	0.40	1.48	55500 12500	38400 8640	1.44	262000 58900			47679	47620A
76.200 3.0000	133.350 5.2500	39.688 1.5625	259000 58200	0.40	1.49	67100 15100	46200 10400	1.45	353000 79300			HM516442	HM516410
76.200 3.0000	135.733 5.3438	44.450 1.7500	303000 68100	0.41	1.48	78500 17600	54600 12300	1.44	380000 85400			5760	5735
76.200 3.0000	136.525 5.3750	30.162 1.1875	154000 34700	0.44	1.35	40000 9000	30500 6850	1.31	216000 48600			495A	493
76.200 3.0000	136.525 5.3750	30.162 1.1875	154000 34700	0.44	1.35	40000 9000	30500 6850	1.31	216000 48600			495AX	493
76.200 3.0000	136.525 5.3750	46.038 1.8125	319000 71700	0.47	1.27	82700 18600	67000 15100	1.24	405000 91000			H715346	H715311
76.200 3.0000	139.700 5.5000	36.512 1.4375	207000 46500	0.40	1.49	53600 12100	37100 8330	1.45	291000 65400			575	572X
76.200 3.0000	139.700 5.5000	46.038 1.8125	319000 71700	0.47	1.27	82700 18600	67000 15100	1.24	405000 91000			H715346	H715310
76.200 3.0000	139.992 5.5115	36.512 1.4375	207000 46500	0.40	1.49	53600 12100	37100 8330	1.45	291000 65400			575	572
76.200 3.0000	139.992 5.5115	36.512 1.4375	214000 48100	0.40	1.48	55500 12500	38400 8640	1.44	262000 58900			47679	47621
76.200 3.0000	139.992 5.5115	36.512 1.4375	214000 48100	0.40	1.48	55500 12500	38400 8640	1.44	262000 58900			47680	47621
76.200 3.0000	139.992 5.5115	36.512 1.4375	207000 46500	0.40	1.49	53600 12100	37100 8330	1.45	291000 65400			575-S	572
76.200 3.0000	142.138 5.5960	44.450 1.7500	241000 54200	0.39	1.55	62500 14000	41300 9280	1.51	318000 71400			HM515745	HM515716
76.200 3.0000	146.050 5.7500	41.275 1.6250	247000 55500	0.41	1.47	64000 14400	44800 10100	1.43	335000 75300			659	653

<sup>(1)</sup>Based on 1 x 10<sup>6</sup> revolutions L<sub>10</sub> life, for the ISO life-calculation method.

<sup>(2)</sup>Consult your Timken engineer for instructions on use or review the Timken Engineering Manual on timken.com/catalogs.

<sup>(3)</sup>Based on 90 x 10<sup>6</sup> revolutions L<sub>10</sub> life, for The Timken Company life-calculation method. C<sub>90</sub> and C<sub>a90</sub> are radial and thrust values.

Bearing Dimensions											Geometry Factors			Bearing Weight
Width B	Width C	Eff. Ctr. a <sup>(4)</sup>	Shaft			Housing			Cage		G <sub>1</sub>	G <sub>2</sub>	C <sub>g</sub>	
			Max Shaft Fillet Radius R <sup>(5)</sup>	Backing Shoulder Dia. d <sub>a</sub> d <sub>b</sub>		Max Housing Fillet Radius r <sup>(5)</sup>	Backing Shoulder Dia. D <sub>a</sub> D <sub>b</sub>		A <sub>a</sub> <sup>(6)</sup>	A <sub>b</sub> <sup>(7)</sup>				
mm in.	mm in.	mm in.	mm in.	mm in.	mm in.	mm in.	mm in.	mm in.	mm in.	mm in.				kg lbs.
33.338 1.3125	26.195 1.0313	-4.3 -0.17	3.5 0.14	85.0 3.35	91.0 3.58	3.3 0.13	128.0 5.04	119.0 4.69	2.3 0.09	2.4 0.10	119.4	29.2	0.1273	1.92 4.22
33.338 1.3125	26.195 1.0313	-4.3 -0.17	0.8 0.03	85.0 3.35	86.0 3.39	3.3 0.13	128.0 5.04	119.0 4.69	2.3 0.09	2.4 0.10	119.4	29.2	0.1273	1.92 4.23
33.338 1.3125	26.195 1.0313	-4.3 -0.17	6.4 0.25	85.0 3.35	97.0 3.82	3.3 0.13	128.0 5.04	119.0 4.69	2.3 0.09	2.4 0.10	119.4	29.2	0.1273	1.88 4.14
33.338 1.3125	26.195 1.0313	-4.3 -0.17	3.5 0.14	85.0 3.35	91.0 3.58	0.8 0.03	128.0 5.04	121.0 4.76	2.3 0.09	2.4 0.10	119.4	29.2	0.1273	1.92 4.23
39.688 1.5625	32.545 1.2813	-7.4 -0.29	3.5 0.14	87.0 3.43	93.0 3.66	3.3 0.13	128.0 5.04	118.0 4.65	1.7 0.06	2.5 0.10	154.1	43.1	0.0955	2.40 5.30
46.100 1.8150	34.925 1.3750	-11.7 -0.46	3.5 0.14	88.0 3.46	94.0 3.70	3.3 0.13	130.0 5.12	119.0 4.69	5.3 0.21	1.5 0.06	144.9	31.6	0.0940	2.68 5.92
29.769 1.1720	22.225 0.8750	-0.8 -0.03	3.5 0.14	86.0 3.39	92.0 3.62	3.3 0.13	130.0 5.12	122.0 4.80	2.5 0.09	2.2 0.09	104.6	29.3	0.1252	1.80 3.96
29.769 1.1720	22.225 0.8750	-0.8 -0.03	6.4 0.25	86.0 3.39	98.0 3.86	3.3 0.13	130.0 5.12	122.0 4.80	2.5 0.09	2.2 0.09	104.6	29.3	0.1252	1.77 3.90
46.038 1.8125	36.512 1.4375	-8.6 -0.34	3.5 0.14	88.0 3.46	98.0 3.86	3.3 0.13	132.0 5.20	118.0 4.65	4.1 0.16	2.0 0.08	147.1	33.5	0.0993	2.92 6.42
36.098 1.4212	28.575 1.1250	-5.3 -0.21	3.5 0.14	86.0 3.39	92.0 3.62	3.3 0.13	133.0 5.24	125.0 4.92	3.4 0.13	1.9 0.08	125.7	32.0	0.1295	2.34 5.17
46.038 1.8125	36.512 1.4375	-8.6 -0.34	3.5 0.14	88.0 3.46	98.0 3.86	3.3 0.13	133.0 5.24	120.0 4.72	4.1 0.16	2.0 0.08	147.1	33.5	0.0993	3.10 6.82
36.098 1.4212	28.575 1.1250	-5.3 -0.21	3.5 0.14	86.0 3.39	92.0 3.62	3.3 0.13	133.0 5.24	125.0 4.92	3.4 0.13	1.9 0.08	125.7	32.0	0.1295	2.35 5.20
33.338 1.3125	29.370 1.1563	-4.3 -0.17	3.5 0.14	85.0 3.35	91.0 3.58	3.3 0.13	130.0 5.12	122.0 4.80	2.3 0.09	2.4 0.10	119.4	29.2	0.1273	2.33 5.14
33.338 1.3125	29.370 1.1563	-4.3 -0.17	0.8 0.03	85.0 3.35	86.0 3.39	3.3 0.13	130.0 5.12	122.0 4.80	2.3 0.09	2.4 0.10	119.4	29.2	0.1273	2.33 5.15
36.098 1.4212	28.575 1.1250	-5.3 -0.21	6.8 0.27	86.0 3.39	99.0 3.90	3.3 0.13	133.0 5.24	125.0 4.92	3.4 0.13	1.9 0.08	125.7	32.0	0.1295	2.32 5.12
46.100 1.8150	33.338 1.3125	-10.9 -0.43	3.5 0.14	87.0 3.43	92.0 3.62	3.3 0.13	133.0 5.24	124.0 4.88	5.9 0.23	-1.2 -0.05	121.7	26.3	0.0869	2.90 6.41
41.275 1.6250	31.750 1.2500	-7.9 -0.31	3.5 0.14	87.0 3.43	93.0 3.66	3.3 0.13	139.0 5.47	131.0 5.16	4.5 0.17	2.1 0.08	136.6	27.3	0.0919	3.01 6.63

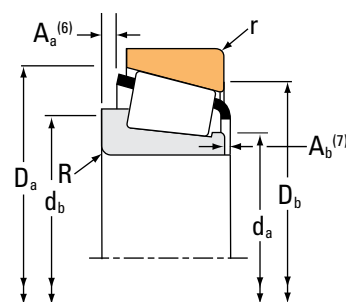
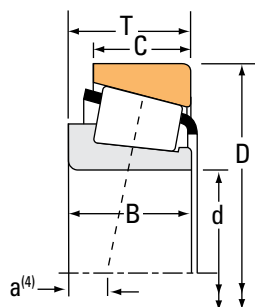
(4) Negative value indicates effective center inside cone (inner-ring) backface.  
 (5) These maximum fillet radii will be cleared by the bearing corners.  
 (6) Negative value indicates cage extends beyond cone (inner-ring) backface.  
 (7) Negative value indicates cage that does not extend beyond cone (inner-ring) front face.

Continued on next page.

# TAPERED ROLLER BEARINGS

## SINGLE-ROW • TYPE TS

### TYPE TS



Bearing Dimensions			Load Ratings							Part Number		
Bore d	O.D. D	Width T	Dynamic <sup>(1)</sup> C <sub>1</sub>		Factors <sup>(2)</sup> e Y		Dynamic <sup>(3)</sup> C <sub>90</sub> C <sub>a90</sub>		Factors <sup>(2)</sup> K	Static C <sub>0</sub>	Inner	Outer
			N lbf				N lbf	N lbf		N lbf		
mm in.	mm in.	mm in.										
76.200 3.0000	149.225 5.8750	53.975 2.1250	411000 92400		0.36	1.66	107000 24000	66000 14800	1.61	463000 104000	6461	6420
76.200 3.0000	149.225 5.8750	53.975 2.1250	411000 92400		0.36	1.66	107000 24000	66000 14800	1.61	463000 104000	6466	6420
76.200 3.0000	149.225 5.8750	53.975 2.1250	411000 92400		0.36	1.66	107000 24000	66000 14800	1.61	463000 104000	6461A	6420
76.200 3.0000	150.000 5.9055	35.966 1.4160	216000 48600		0.44	1.36	56000 12600	42400 9530	1.32	319000 71600	590A	JM719113
76.200 3.0000	150.089 5.9090	44.450 1.7500	377000 84700		0.33	1.84	97600 21900	54400 12200	1.80	417000 93800	748-S	742
76.200 3.0000	152.400 6.0000	39.688 1.5625	216000 48600		0.44	1.36	56000 12600	42400 9530	1.32	319000 71600	590A	592A
76.200 3.0000	152.400 6.0000	41.275 1.6250	247000 55500		0.41	1.47	64000 14400	44800 10100	1.43	335000 75300	659	652
76.200 3.0000	160.000 6.2992	53.975 2.1250	439000 98800		0.40	1.50	114000 25600	78100 17600	1.46	523000 118000	6576	6525X
76.200 3.0000	161.925 6.3750	47.625 1.8750	327000 73600		0.34	1.76	84800 19100	49500 11100	1.71	441000 99200	755	752
76.200 3.0000	161.925 6.3750	49.212 1.9375	353000 79300		0.71	0.85	91400 20600	111000 24900	0.82	330000 74200	9285	9220
76.200 3.0000	161.925 6.3750	53.975 2.1250	439000 98800		0.40	1.50	114000 25600	78100 17600	1.46	523000 118000	6576	6535
76.200 3.0000	161.925 6.3750	53.975 2.1250	439000 98800		0.40	1.50	114000 25600	78100 17600	1.46	523000 118000	6575	6535
76.200 3.0000	161.925 6.3750	53.975 2.1250	439000 98800		0.40	1.50	114000 25600	78100 17600	1.46	523000 118000	6576	6536
76.200 3.0000	161.925 6.3750	53.975 2.1250	439000 98800		0.40	1.50	114000 25600	78100 17600	1.46	523000 118000	6576C	6535
76.200 3.0000	168.275 6.6250	47.625 1.8750	327000 73600		0.34	1.76	84800 19100	49500 11100	1.71	441000 99200	755	753
76.200 3.0000	168.275 6.6250	53.975 2.1250	485000 109000		0.30	2.00	126000 28300	64400 14500	1.95	522000 117000	837	832
76.200 3.0000	168.275 6.6250	53.975 2.1250	485000 109000		0.30	2.00	126000 28300	64400 14500	1.95	522000 117000	843	832

<sup>(1)</sup>Based on  $1 \times 10^6$  revolutions  $L_{10}$  life, for the ISO life-calculation method.

<sup>(2)</sup>Consult your Timken engineer for instructions on use or review the Timken Engineering Manual on [timken.com/catalogs](http://timken.com/catalogs).

<sup>(3)</sup>Based on  $90 \times 10^6$  revolutions  $L_{10}$  life, for The Timken Company life-calculation method.  $C_{90}$  and  $C_{a90}$  are radial and thrust values.

Bearing Dimensions											Geometry Factors			Bearing Weight
Width B	Width C	Eff. Ctr. a <sup>(4)</sup>	Shaft			Housing			Cage		G <sub>1</sub>	G <sub>2</sub>	C <sub>g</sub>	
			Max Shaft Fillet Radius R <sup>(5)</sup>	Backing Shoulder Dia. d <sub>a</sub> d <sub>b</sub>		Max Housing Fillet Radius r <sup>(5)</sup>	Backing Shoulder Dia. D <sub>a</sub> D <sub>b</sub>		A <sub>a</sub> <sup>(6)</sup>	A <sub>b</sub> <sup>(7)</sup>				
mm in.	mm in.	mm in.	mm in.	mm in.	mm in.	mm in.	mm in.	mm in.	mm in.	mm in.				kg lbs.
54.229 2.1350	44.450 1.7500	-15.0 -0.59	3.5 0.14	89.0 3.52	96.0 3.78	3.3 0.13	140.0 5.51	129.0 5.08	2.7 0.10	0.7 0.03	158.3	29.1	0.0931	4.24 9.36
54.229 2.1350	44.450 1.7500	-15.0 -0.59	6.4 0.25	89.0 3.52	102.0 4.02	3.3 0.13	140.0 5.51	129.0 5.08	2.7 0.10	0.7 0.03	158.3	29.1	0.0931	4.22 9.30
54.229 2.1350	44.450 1.7500	-15.0 -0.59	9.7 0.38	89.0 3.52	108.0 4.25	3.3 0.13	140.0 5.51	129.0 5.08	2.7 0.10	0.7 0.03	158.3	29.1	0.0931	4.16 9.18
36.322 1.4300	27.000 1.0630	-2.5 -0.10	3.5 0.14	89.0 3.50	95.0 3.74	2.5 0.10	143.0 5.63	135.0 5.31	4.1 0.16	1.7 0.07	151.4	38.3	0.1416	2.92 6.44
46.672 1.8375	36.512 1.4375	-11.9 -0.47	3.5 0.14	87.0 3.43	93.0 3.66	3.3 0.13	142.0 5.59	134.0 5.28	1.8 0.07	1.3 0.05	159.6	26.3	0.0898	3.66 8.06
36.322 1.4300	30.162 1.1875	-2.5 -0.10	3.5 0.14	89.0 3.50	95.0 3.74	3.3 0.13	144.0 5.67	135.0 5.31	4.1 0.16	1.7 0.07	151.4	38.3	0.1416	3.21 7.08
41.275 1.6250	31.750 1.2500	-7.9 -0.31	3.5 0.14	87.0 3.43	93.0 3.66	3.3 0.13	141.0 5.55	134.0 5.28	4.5 0.17	2.1 0.08	136.6	27.3	0.0919	3.36 7.41
55.100 2.1693	44.450 1.7500	-13.2 -0.52	3.5 0.14	92.0 3.62	99.0 3.90	3.0 0.12	153.4 6.04	141.0 5.55	4.1 0.16	0.9 0.04	198.6	33.5	0.1037	5.26 11.60
48.260 1.9000	38.100 1.5000	-11.9 -0.47	3.5 0.14	92.0 3.62	98.0 3.86	3.3 0.13	150.0 5.91	144.0 5.67	3.2 0.12	1.0 0.04	177.2	29.4	0.0945	4.70 10.36
46.038 1.8125	31.750 1.2500	0.0 0.00	3.5 0.14	89.0 3.50	111.0 4.37	3.3 0.13	153.0 6.03	138.0 5.43	9.0 0.35	4.1 0.16	102.5	16.1	0.0984	4.17 9.21
55.100 2.1693	42.862 1.6875	-13.2 -0.52	3.5 0.14	92.0 3.62	99.0 3.90	3.3 0.13	154.0 6.06	141.0 5.55	4.1 0.16	0.9 0.04	198.6	33.5	0.1037	5.41 11.93
55.100 2.1693	42.862 1.6875	-13.2 -0.52	6.4 0.25	92.0 3.62	104.0 4.09	3.3 0.13	154.0 6.06	141.0 5.55	4.1 0.16	0.9 0.04	198.6	33.5	0.1037	5.40 11.91
55.100 2.1693	42.862 1.6875	-13.2 -0.52	3.5 0.14	92.0 3.62	99.0 3.90	0.8 0.03	154.0 6.06	144.0 5.67	4.1 0.16	0.9 0.04	198.6	33.5	0.1037	5.41 11.94
55.100 2.1693	42.862 1.6875	-13.2 -0.52	3.5 0.14	94.0 3.70	101.0 3.98	3.3 0.13	154.0 6.06	141.0 5.55	4.1 0.16	0.9 0.04	198.6	33.5	0.1037	5.41 11.92
48.260 1.9000	38.100 1.5000	-11.9 -0.47	3.5 0.14	92.0 3.62	98.0 3.86	3.3 0.13	150.0 5.91	147.0 5.79	3.2 0.12	1.0 0.04	177.2	29.4	0.0945	5.17 11.40
56.363 2.2190	41.275 1.6250	-18.5 -0.73	0.8 0.03	89.0 3.50	90.0 3.54	3.3 0.13	155.0 6.10	149.0 5.87	5.2 0.20	1.6 0.07	197.9	34.8	0.0937	5.79 12.75
56.363 2.2190	41.275 1.6250	-18.5 -0.73	6.4 0.25	89.0 3.50	101.0 3.98	3.3 0.13	155.0 6.10	149.0 5.87	5.2 0.20	1.6 0.07	197.9	34.8	0.0937	5.77 12.71

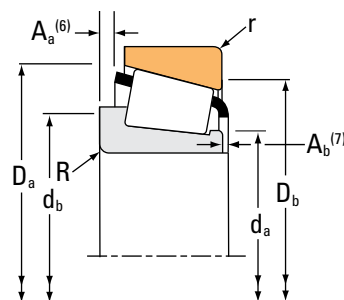
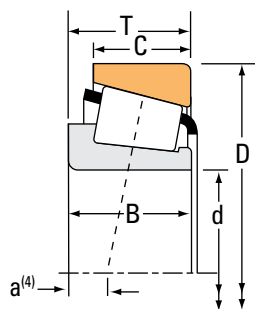
<sup>(4)</sup>Negative value indicates effective center inside cone (inner-ring) backface.  
<sup>(5)</sup>These maximum fillet radii will be cleared by the bearing corners.  
<sup>(6)</sup>Negative value indicates cage extends beyond cone (inner-ring) backface.  
<sup>(7)</sup>Negative value indicates cage that does not extend beyond cone (inner-ring) front face.

Continued on next page.

# TAPERED ROLLER BEARINGS

## SINGLE-ROW • TYPE TS

### TYPE TS



Bearing Dimensions			Load Ratings							Part Number			
Bore d	O.D. D	Width T	Dynamic <sup>(1)</sup>		Factors <sup>(2)</sup>		Dynamic <sup>(3)</sup>		Factors <sup>(2)</sup>		Static C <sub>0</sub>	Inner	Outer
			C <sub>1</sub>	e	Y	C <sub>90</sub>	C <sub>a90</sub>	K	N	N			
mm in.	mm in.	mm in.	N lbf			N lbf	N lbf		N lbf				
76.200 3.0000	171.450 6.7500	49.212 1.9375	363000 81600	0.76	0.79	94100 21200	123000 27700	0.76	351000 78800			9380	9321
76.200 3.0000	171.450 6.7500	52.388 2.0625	363000 81600	0.76	0.79	94100 21200	123000 27700	0.76	351000 78800			9378	9321
76.200 3.0000	177.800 7.0000	52.388 2.0625	363000 81600	0.76	0.79	94100 21200	123000 27700	0.76	351000 78800			9380	9320
76.200 3.0000	177.800 7.0000	55.562 2.1875	363000 81600	0.76	0.79	94100 21200	123000 27700	0.76	351000 78800			9378	9320
76.200 3.0000	180.975 7.1250	53.975 2.1250	448000 101000	0.73	0.82	116000 26100	146000 32700	0.80	458000 103000			H917840	H917810
76.200 3.0000	190.500 7.5000	57.150 2.2500	534000 120000	0.33	1.79	138000 31100	79300 17800	1.74	692000 156000			HH221430	HH221410
77.788 3.0625	117.475 4.6250	25.400 1.0000	118000 26500	0.51	1.18	30600 6870	26700 5990	1.15	183000 41200			LM814849	LM814810
77.788 3.0625	120.000 4.7244	23.000 0.9055	121000 27200	0.45	1.33	31400 7060	24200 5450	1.30	136000 30600			34306	34472X
77.788 3.0625	120.650 4.7500	27.783 1.0938	118000 26500	0.51	1.18	30600 6870	26700 5990	1.15	183000 41200			LM814849	LM814814
77.788 3.0625	121.442 4.7812	24.608 0.9688	121000 27200	0.45	1.33	31400 7060	24200 5450	1.30	136000 30600			34306	34478
77.788 3.0625	121.442 4.7812	24.608 0.9688	102000 23000	0.45	1.33	26500 5960	20500 4600	1.30	136000 30600			34307	34478
77.788 3.0625	127.000 5.0000	30.162 1.1875	161000 36200	0.42	1.43	41800 9390	29900 6730	1.39	222000 49800			42690	42620
77.788 3.0625	133.350 5.2500	30.162 1.1875	154000 34700	0.44	1.35	40000 9000	30500 6850	1.31	216000 48600			495AS	492A
77.788 3.0625	135.733 5.3438	44.450 1.7500	303000 68100	0.41	1.48	78500 17600	54600 12300	1.44	380000 85400			5795	5735
77.788 3.0625	136.525 5.3750	46.038 1.8125	319000 71700	0.47	1.27	82700 18600	67000 15100	1.24	405000 91000			H715348	H715311
77.788 3.0625	139.700 5.5000	46.038 1.8125	319000 71700	0.47	1.27	82700 18600	67000 15100	1.24	405000 91000			H715348	H715310
77.788 3.0625	164.975 6.4951	49.500 1.9488	352000 79000	0.51	1.17	91100 20500	79700 17900	1.14	400000 90000			H816249	H816210

<sup>(1)</sup>Based on 1 x 10<sup>6</sup> revolutions L<sub>10</sub> life, for the ISO life-calculation method.

<sup>(2)</sup>Consult your Timken engineer for instructions on use or review the Timken Engineering Manual on timken.com/catalogs.

<sup>(3)</sup>Based on 90 x 10<sup>6</sup> revolutions L<sub>10</sub> life, for The Timken Company life-calculation method. C<sub>90</sub> and C<sub>a90</sub> are radial and thrust values.



Bearing Dimensions											Geometry Factors			Bearing Weight
Width B	Width C	Eff. Ctr. a <sup>(4)</sup>	Shaft			Housing			Cage		G <sub>1</sub>	G <sub>2</sub>	C <sub>g</sub>	
			Max Shaft Fillet Radius R <sup>(5)</sup>	Backing Shoulder Dia. d <sub>a</sub>	mm in.	Max Housing Fillet Radius r <sup>(5)</sup>	Backing Shoulder Dia. D <sub>a</sub>	mm in.	A <sub>a</sub> <sup>(6)</sup>	A <sub>b</sub> <sup>(7)</sup>				
mm in.	mm in.	mm in.	mm in.	mm in.	mm in.	mm in.	mm in.	mm in.	mm in.	mm in.			kg lbs.	
46.038 1.8125	31.750 1.2500	4.3 0.17	3.5 0.14	98.2 3.87	105.0 4.13	3.3 0.13	164.0 6.46	147.0 5.79	8.9 0.35	3.9 0.16	117.9	18.6	0.1053	5.11 11.26
50.800 2.0000	31.750 1.2500	1.3 0.05	3.5 0.14	98.2 3.87	105.0 4.13	3.3 0.13	164.0 6.46	147.0 5.79	12.1 0.47	2.3 0.09	117.9	18.6	0.1053	5.35 11.80
46.038 1.8125	34.925 1.3750	4.3 0.17	3.5 0.14	98.2 3.87	105.0 4.13	3.3 0.13	164.0 6.46	148.0 5.83	8.9 0.35	3.9 0.16	117.9	18.6	0.1053	5.81 12.80
50.800 2.0000	34.925 1.3750	1.3 0.05	3.5 0.14	98.2 3.87	105.0 4.13	3.3 0.13	164.0 6.46	148.0 5.83	12.1 0.47	2.3 0.09	117.9	18.6	0.1053	6.05 13.34
53.183 2.0938	35.720 1.4063	0.5 0.02	3.5 0.14	100.1 3.94	110.0 4.33	3.3 0.13	170.0 6.69	152.0 5.98	9.5 0.37	2.8 0.11	147.0	20.7	0.1123	6.55 14.45
57.531 2.2650	46.038 1.8125	-15.0 -0.59	3.5 0.14	95.0 3.74	101.0 3.98	3.3 0.13	179.0 7.05	171.0 6.73	2.5 0.10	3.2 0.13	265.6	28.4	0.1072	8.60 18.95
25.400 1.0000	19.050 0.7500	2.3 0.09	3.5 0.14	85.0 3.35	91.0 3.58	3.3 0.13	113.0 4.45	105.0 4.13	2.4 0.09	1.5 0.06	88.6	36.6	0.1239	0.91 2.00
23.012 0.9060	16.000 0.6299	1.5 0.06	3.5 0.14	84.0 3.31	91.0 3.58	2.3 0.09	115.0 4.53	110.0 4.33	2.6 0.10	2.1 0.09	69.3	27.0	0.1093	0.83 1.84
25.400 1.0000	26.195 1.0313	2.3 0.09	3.5 0.14	85.0 3.35	91.0 3.58	3.3 0.13	115.8 4.56	107.0 4.21	2.4 0.09	1.5 0.06	88.6	36.6	0.1239	1.11 2.45
23.012 0.9060	17.462 0.6875	1.5 0.06	3.5 0.14	84.0 3.31	91.0 3.58	2.0 0.08	116.0 4.57	110.0 4.33	2.6 0.10	2.1 0.09	69.3	27.0	0.1093	0.90 2.01
23.012 0.9060	17.462 0.6875	1.5 0.06	6.4 0.25	84.0 3.31	96.0 3.78	2.0 0.08	116.0 4.57	110.0 4.33	2.6 0.10	2.1 0.09	69.3	27.0	0.1093	0.88 1.95
31.000 1.2205	22.225 0.8750	-2.8 -0.11	3.5 0.14	85.0 3.35	91.0 3.58	3.3 0.13	121.0 4.76	114.0 4.49	3.3 0.13	0.9 0.04	96.2	28.6	0.1197	1.37 3.01
29.769 1.1720	22.225 0.8750	-0.8 -0.03	3.5 0.14	87.0 3.43	93.0 3.66	3.3 0.13	128.0 5.04	120.0 4.72	2.5 0.09	2.2 0.09	104.6	29.3	0.1252	1.63 3.61
46.100 1.8150	34.925 1.3750	-11.7 -0.46	3.5 0.14	89.0 3.50	96.0 3.78	3.3 0.13	130.0 5.12	119.0 4.69	5.3 0.21	1.5 0.06	144.9	31.6	0.0940	2.61 5.77
46.038 1.8125	36.512 1.4375	-8.6 -0.34	3.5 0.14	88.0 3.46	99.0 3.90	3.3 0.13	132.0 5.20	118.0 4.65	4.1 0.16	2.0 0.08	147.1	33.5	0.0993	2.84 6.26
46.038 1.8125	36.512 1.4375	-8.6 -0.34	3.5 0.14	88.0 3.46	99.0 3.90	3.3 0.13	133.0 5.24	120.0 4.72	4.1 0.16	2.0 0.08	147.1	33.5	0.0993	3.02 6.67
46.248 1.8208	36.250 1.4272	-6.4 -0.25	3.5 0.14	92.5 3.64	102.0 4.02	3.3 0.13	154.5 6.08	144.0 5.67	4.6 0.18	6.0 0.24	127.4	23.2	0.0959	4.63 10.21

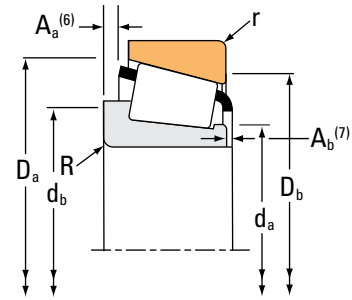
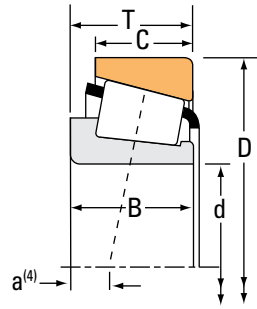
<sup>(4)</sup>Negative value indicates effective center inside cone (inner-ring) backface.  
<sup>(5)</sup>These maximum fillet radii will be cleared by the bearing corners.  
<sup>(6)</sup>Negative value indicates cage extends beyond cone (inner-ring) backface.  
<sup>(7)</sup>Negative value indicates cage that does not extend beyond cone (inner-ring) front face.

Continued on next page.

# TAPERED ROLLER BEARINGS

## SINGLE-ROW • TYPE TS

### TYPE TS



Bearing Dimensions			Load Ratings							Part Number		
Bore d	O.D. D	Width T	Dynamic <sup>(1)</sup>		Factors <sup>(2)</sup>		Dynamic <sup>(3)</sup>		Factors <sup>(2)</sup>	Static	Inner	Outer
			C <sub>1</sub>	e	Y	C <sub>90</sub>	C <sub>a90</sub>	K	C <sub>0</sub>			
mm in.	mm in.	mm in.	N lbf			N lbf	N lbf			N lbf		
79.375 3.1250	140.000 5.5118	44.450 1.7500	241000 54200	0.39	1.55	62500 14000	41300 9280	1.51		318000 71400	HM515749	HM515714
79.375 3.1250	142.138 5.5960	44.450 1.7500	241000 54200	0.39	1.55	62500 14000	41300 9280	1.51		318000 71400	HM515749	HM515716
79.375 3.1250	146.050 5.7500	41.275 1.6250	247000 55500	0.41	1.47	64000 14400	44800 10100	1.43		335000 75300	661	653
79.375 3.1250	147.638 5.8125	35.717 1.4062	216000 48600	0.44	1.36	56000 12600	42400 9530	1.32		319000 71600	595A	592XE
79.375 3.1250	150.000 5.9055	35.992 1.4170	216000 48600	0.44	1.36	56000 12600	42400 9530	1.32		319000 71600	595A	593X
79.375 3.1250	150.089 5.9090	44.450 1.7500	377000 84700	0.33	1.84	97600 21900	54400 12200	1.80		417000 93800	750	742
79.375 3.1250	152.400 6.0000	35.717 1.4062	216000 48600	0.44	1.36	56000 12600	42400 9530	1.32		319000 71600	595A	592AS
79.375 3.1250	152.400 6.0000	39.688 1.5625	216000 48600	0.44	1.36	56000 12600	42400 9530	1.32		319000 71600	595A	592A
79.375 3.1250	152.400 6.0000	41.275 1.6250	247000 55500	0.41	1.47	64000 14400	44800 10100	1.43		335000 75300	661	652
79.375 3.1250	161.925 6.3750	47.625 1.8750	327000 73600	0.34	1.76	84800 19100	49500 11100	1.71		441000 99200	756A	752
79.375 3.1250	190.500 7.5000	57.150 2.2500	534000 120000	0.33	1.79	138000 31100	79300 17800	1.74		692000 156000	HH221431	HH221410
79.975 3.1486	146.975 5.7864	40.000 1.5748	325000 73000	0.33	1.80	84200 18900	47900 10800	1.76		388000 87300	HM218238	HM218210
79.975 3.1486	152.400 6.0000	40.000 1.5748	325000 73000	0.33	1.80	84200 18900	47900 10800	1.76		388000 87300	HM218238	HM218215
79.985 3.1490	139.992 5.5115	36.512 1.4375	207000 46500	0.40	1.49	53600 12100	37100 8330	1.45		291000 65400	578	572
79.985 3.1490	147.638 5.8125	35.717 1.4062	216000 48600	0.44	1.36	56000 12600	42400 9530	1.32		319000 71600	590	592XE
79.985 3.1490	152.400 6.0000	39.688 1.5625	216000 48600	0.44	1.36	56000 12600	42400 9530	1.32		319000 71600	590	592A
80.000 3.1496	125.000 4.9213	24.000 0.9449	107000 24000	0.45	1.33	27700 6230	21400 4820	1.29		141000 31800	JP8049	JP8010

<sup>(1)</sup>Based on 1 x 10<sup>6</sup> revolutions L<sub>10</sub> life, for the ISO life-calculation method.

<sup>(2)</sup>Consult your Timken engineer for instructions on use or review the Timken Engineering Manual on timken.com/catalogs.

<sup>(3)</sup>Based on 90 x 10<sup>6</sup> revolutions L<sub>10</sub> life, for The Timken Company life-calculation method. C<sub>90</sub> and C<sub>a90</sub> are radial and thrust values.

Bearing Dimensions											Geometry Factors			Bearing Weight
Width B	Width C	Eff. Ctr. a <sup>(4)</sup>	Shaft			Housing			Cage		G <sub>1</sub>	G <sub>2</sub>	C <sub>g</sub>	
			Max Shaft Fillet Radius R <sup>(5)</sup>	Backing Shoulder Dia. d <sub>a</sub> d <sub>b</sub>		Max Housing Fillet Radius r <sup>(5)</sup>	Backing Shoulder Dia. D <sub>a</sub> D <sub>b</sub>		A <sub>a</sub> <sup>(6)</sup>	A <sub>b</sub> <sup>(7)</sup>				
mm in.	mm in.	mm in.	mm in.	mm in.	mm in.	mm in.	mm in.	mm in.	mm in.	mm in.				kg lbs.
46.100 1.8150	33.338 1.3125	-10.9 -0.43	3.5 0.14	89.6 3.52	95.0 3.74	3.3 0.13	133.0 5.24	123.0 4.84	5.9 0.23	-1.2 -0.05	121.7	26.3	0.0869	2.64 5.83
46.100 1.8150	33.338 1.3125	-10.9 -0.43	3.5 0.14	89.6 3.52	95.0 3.74	3.3 0.13	133.0 5.24	124.0 4.88	5.9 0.23	-1.2 -0.05	121.7	26.3	0.0869	2.76 6.10
41.275 1.6250	31.750 1.2500	-7.9 -0.31	3.5 0.14	90.0 3.54	96.0 3.78	3.3 0.13	139.0 5.47	131.0 5.16	4.5 0.17	2.1 0.08	136.6	27.3	0.0919	2.88 6.35
36.322 1.4300	26.192 1.0312	-2.5 -0.10	3.5 0.14	91.0 3.58	98.0 3.86	0.8 0.03	142.0 5.59	135.0 5.31	4.1 0.16	1.7 0.07	151.4	38.3	0.1416	2.69 5.93
36.322 1.4300	27.000 1.0630	-2.5 -0.10	3.5 0.14	91.0 3.58	98.0 3.86	3.0 0.12	142.0 5.59	134.0 5.28	4.1 0.16	1.7 0.07	151.4	38.3	0.1416	2.81 6.19
46.672 1.8375	36.512 1.4375	-11.9 -0.47	3.5 0.14	90.0 3.54	96.0 3.78	3.3 0.13	142.0 5.59	134.0 5.28	1.8 0.07	1.3 0.05	159.6	26.3	0.0898	3.51 7.73
36.322 1.4300	26.192 1.0312	-2.5 -0.10	3.5 0.14	91.0 3.58	98.0 3.86	0.8 0.03	144.0 5.67	137.0 5.39	4.1 0.16	1.7 0.07	151.4	38.3	0.1416	2.93 6.45
36.322 1.4300	30.162 1.1875	-2.5 -0.10	3.5 0.14	91.0 3.58	98.0 3.86	3.3 0.13	144.0 5.67	135.0 5.31	4.1 0.16	1.7 0.07	151.4	38.3	0.1416	3.10 6.84
41.275 1.6250	31.750 1.2500	-7.9 -0.31	3.5 0.14	90.0 3.54	96.0 3.78	3.3 0.13	141.0 5.55	134.0 5.28	4.5 0.17	2.1 0.08	136.6	27.3	0.0919	3.23 7.14
48.260 1.9000	38.100 1.5000	-11.9 -0.47	8.0 0.31	94.0 3.70	109.0 4.29	3.3 0.13	150.0 5.91	144.0 5.67	3.2 0.12	1.0 0.04	177.2	29.4	0.0945	4.53 9.99
57.531 2.2650	46.038 1.8125	-15.0 -0.59	3.5 0.14	97.0 3.82	103.0 4.06	3.3 0.13	179.0 7.05	171.0 6.73	2.5 0.10	3.2 0.13	265.6	28.4	0.1072	8.42 18.57
40.000 1.5748	32.500 1.2795	-8.6 -0.34	7.0 0.28	91.0 3.58	104.0 4.09	3.5 0.14	141.0 5.55	133.0 5.24	1.4 0.05	3.0 0.12	168.2	34.7	0.0921	2.94 6.50
40.000 1.5748	32.500 1.2795	-8.6 -0.34	7.0 0.28	91.0 3.58	104.0 4.09	3.3 0.13	143.0 5.63	135.0 5.31	1.4 0.05	3.0 0.12	168.2	34.7	0.0921	3.27 7.22
36.098 1.4212	28.575 1.1250	-5.3 -0.21	3.5 0.14	89.0 3.50	95.0 3.74	3.3 0.13	133.0 5.24	125.0 4.92	3.4 0.13	1.9 0.08	125.7	32.0	0.1295	2.22 4.91
36.322 1.4300	26.192 1.0312	-2.5 -0.10	3.5 0.14	91.0 3.58	98.0 3.86	0.8 0.03	142.0 5.59	135.0 5.31	4.1 0.16	1.7 0.07	151.4	38.3	0.1416	2.67 5.88
36.322 1.4300	30.162 1.1875	-2.5 -0.10	3.5 0.14	91.0 3.58	98.0 3.86	3.3 0.13	144.0 5.67	135.0 5.31	4.1 0.16	1.7 0.07	151.4	38.3	0.1416	3.08 6.79
22.500 0.8858	17.500 0.6890	2.3 0.09	2.0 0.08	86.0 3.39	89.0 3.50	2.0 0.08	120.0 4.72	115.0 4.53	1.9 0.07	3.5 0.14	69.7	37.4	0.1095	0.96 2.10

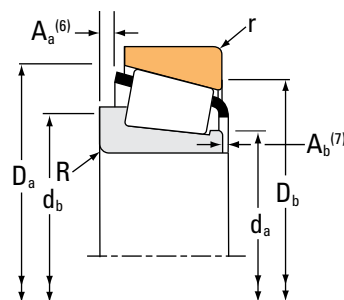
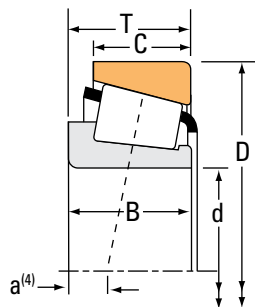
(4) Negative value indicates effective center inside cone (inner-ring) backface.  
 (5) These maximum fillet radii will be cleared by the bearing corners.  
 (6) Negative value indicates cage extends beyond cone (inner-ring) backface.  
 (7) Negative value indicates cage that does not extend beyond cone (inner-ring) front face.

Continued on next page.

# TAPERED ROLLER BEARINGS

SINGLE-ROW • TYPE TS

## TYPE TS



Bearing Dimensions			Load Ratings							Part Number			
Bore d	O.D. D	Width T	Dynamic <sup>(1)</sup>		Factors <sup>(2)</sup>		Dynamic <sup>(3)</sup>		Factors <sup>(2)</sup>		Static C <sub>0</sub>	Inner	Outer
			C <sub>1</sub>	e	Y	C <sub>90</sub>	C <sub>a90</sub>	K	N	N			
mm in.	mm in.	mm in.	N lbf			N lbf	N lbf		N lbf				
80.000 3.1496	130.000 5.1181	35.000 1.3780	199000 44700	0.39	1.54	51500 11600	34200 7700	1.50	283000 63500		JM515649	JM515610	
80.000 3.1496	150.000 5.9055	44.455 1.7502	318000 71400	0.33	1.84	82400 18500	45900 10300	1.80	417000 93800		748	743	
80.000 3.1496	150.089 5.9090	44.450 1.7500	318000 71400	0.33	1.84	82400 18500	45900 10300	1.80	417000 93800		748	742	
80.000 3.1496	160.000 6.2992	45.000 1.7717	264000 59300	0.87	0.69	68400 15400	101000 22800	0.67	339000 76100		JW8049	JW8010	
80.000 3.1496	200.000 7.8740	108.268 2.0772	482000 108000	0.63	0.95	125000 28100	135000 30400	0.92	519000 117000		98316	98788	
80.962 3.1875	133.350 5.2500	30.162 1.1875	154000 34700	0.44	1.35	40000 9000	30500 6850	1.31	216000 48600		496	492A	
80.962 3.1875	133.350 5.2500	33.338 1.3125	214000 48100	0.40	1.48	55500 12500	38400 8640	1.44	262000 58900		47681	47620	
80.962 3.1875	133.350 5.2500	39.688 1.5625	259000 58200	0.40	1.49	67100 15100	46200 10400	1.45	353000 79300		HM516447	HM516410	
80.962 3.1875	133.350 5.2500	39.688 1.5625	259000 58200	0.40	1.49	67100 15100	46200 10400	1.45	353000 79300		HM516447	HM516410A	
80.962 3.1875	136.525 5.3750	30.162 1.1875	154000 34700	0.44	1.35	40000 9000	30500 6850	1.31	216000 48600		496	493	
80.962 3.1875	139.992 5.5115	36.512 1.4375	207000 46500	0.40	1.49	53600 12100	37100 8330	1.45	291000 65400		581	572	
80.962 3.1875	146.050 5.7500	38.100 1.5000	247000 55500	0.41	1.47	64000 14400	44800 10100	1.43	335000 75300		662	653	
80.962 3.1875	150.089 5.9090	44.450 1.7500	377000 84700	0.33	1.84	97600 21900	54400 12200	1.80	417000 93800		740	742	
80.962 3.1875	168.275 6.6250	53.975 2.1250	409000 92000	0.30	2.00	106000 23800	54300 12200	1.95	522000 117000		838	832	
82.550 3.2500	114.300 4.5000	15.083 0.5938	70900 15900	0.31	1.94	18400 4130	9740 2190	1.89	87000 19600		LL116249	LL116210	
82.550 3.2500	115.888 4.5625	20.638 0.8125	90200 20300	0.31	1.95	23400 5260	12300 2770	1.90	147000 33100		L116149	L116110	
82.550 3.2500	125.412 4.9375	25.400 1.0000	117000 26300	0.42	1.44	30400 6830	21600 4860	1.40	178000 39900		27687	27620	

<sup>(1)</sup>Based on 1 x 10<sup>6</sup> revolutions L<sub>10</sub> life, for the ISO life-calculation method.

<sup>(2)</sup>Consult your Timken engineer for instructions on use or review the Timken Engineering Manual on timken.com/catalogs.

<sup>(3)</sup>Based on 90 x 10<sup>6</sup> revolutions L<sub>10</sub> life, for The Timken Company life-calculation method. C<sub>90</sub> and C<sub>a90</sub> are radial and thrust values.

Bearing Dimensions											Geometry Factors			Bearing Weight
Width B	Width C	Eff. Ctr. a <sup>(4)</sup>	Shaft			Housing			Cage		G <sub>1</sub>	G <sub>2</sub>	C <sub>g</sub>	
			Max Shaft Fillet Radius R <sup>(5)</sup>	Backing Shoulder Dia. d <sub>a</sub>	Backing Shoulder Dia. d <sub>b</sub>	Max Housing Fillet Radius r <sup>(5)</sup>	Backing Shoulder Dia. D <sub>a</sub>	Backing Shoulder Dia. D <sub>b</sub>	A <sub>a</sub> <sup>(6)</sup>	A <sub>b</sub> <sup>(7)</sup>				
mm in.	mm in.	mm in.	mm in.	mm in.	mm in.	mm in.	mm in.	mm in.	mm in.	mm in.				kg lbs.
34.000 1.3386	28.500 1.1220	-5.1 -0.20	3.0 0.12	88.0 3.46	94.0 3.70	2.5 0.10	125.0 4.92	117.0 4.61	1.5 0.06	2.8 0.11	118.5	31.1	0.0863	1.71 3.77
46.672 1.8375	35.000 1.3780	-11.9 -0.47	3.0 0.12	90.0 3.54	96.0 3.78	3.3 0.13	142.0 5.59	134.0 5.28	1.8 0.07	1.3 0.05	159.6	26.3	0.0898	3.44 7.57
46.672 1.8375	36.512 1.4375	-11.9 -0.47	3.0 0.12	90.0 3.54	96.0 3.78	3.3 0.13	142.0 5.59	134.0 5.28	1.8 0.07	1.3 0.05	159.6	26.3	0.0898	3.49 7.67
41.000 1.6142	31.000 1.2205	9.7 0.38	3.0 0.12	93.0 3.67	108.0 4.25	3.0 0.12	152.0 5.98	134.0 5.28	7.0 0.27	4.8 0.19	117.3	27.2	0.1094	4.04 8.90
49.212 1.9375	34.925 1.3750	1.3 0.05	3.5 0.14	105.0 4.13	111.0 4.37	3.3 0.13	188.0 7.40	174.0 6.85	8.6 0.34	5.4 0.22	203.4	37.5	0.1197	7.94 17.52
29.769 1.1720	22.225 0.8750	-0.8 -0.03	3.5 0.14	89.0 3.50	95.0 3.74	3.3 0.13	128.0 5.04	120.0 4.72	2.5 0.09	2.2 0.09	104.6	29.3	0.1252	1.54 3.40
33.338 1.3125	26.195 1.0313	-4.3 -0.17	3.5 0.14	89.0 3.50	95.0 3.74	3.3 0.13	128.0 5.04	119.0 4.69	2.3 0.09	2.4 0.10	119.4	29.2	0.1273	1.76 3.86
39.688 1.5625	32.545 1.2813	-7.4 -0.29	3.5 0.14	91.0 3.58	98.0 3.86	3.3 0.13	128.0 5.04	118.0 4.65	1.7 0.06	2.5 0.10	154.1	43.1	0.0955	2.22 4.90
39.688 1.5625	32.545 1.2813	-7.4 -0.29	3.5 0.14	91.0 3.58	98.0 3.86	0.8 0.03	128.0 5.04	120.0 4.72	1.7 0.06	2.5 0.10	154.1	43.1	0.0955	2.23 4.93
29.769 1.1720	22.225 0.8750	-0.8 -0.03	3.5 0.14	89.0 3.50	95.0 3.74	3.3 0.13	130.0 5.12	122.0 4.80	2.5 0.09	2.2 0.09	104.6	29.3	0.1252	1.66 3.66
36.098 1.4212	28.575 1.1250	-5.3 -0.21	3.5 0.14	90.0 3.54	96.0 3.78	3.3 0.13	133.0 5.24	125.0 4.92	3.4 0.13	1.9 0.08	125.7	32.0	0.1295	2.19 4.83
38.100 1.5000	31.750 1.2500	-4.8 -0.19	3.5 0.14	91.0 3.58	98.0 3.86	3.3 0.13	139.0 5.47	131.0 5.16	1.3 0.05	2.1 0.08	136.6	27.3	0.0919	2.69 5.94
46.672 1.8375	36.512 1.4375	-11.9 -0.47	5.0 0.20	91.0 3.58	101.0 3.98	3.3 0.13	142.0 5.59	134.0 5.28	1.8 0.07	1.3 0.05	159.6	26.3	0.0898	3.42 7.54
56.363 2.2190	41.275 1.6250	-18.5 -0.73	0.8 0.03	93.0 3.66	94.0 3.70	3.3 0.13	155.0 6.10	149.0 5.87	5.2 0.20	1.6 0.07	197.9	34.8	0.0937	5.53 12.18
15.083 0.5938	11.112 0.4375	1.5 0.06	1.5 0.06	87.0 3.43	90.0 3.54	1.5 0.06	110.0 4.33	108.0 4.25	0.2 0.01	2.1 0.09	66.2	60.0	0.0944	0.43 0.95
21.433 0.8438	16.670 0.6563	-1.3 -0.05	1.5 0.06	87.0 3.43	90.0 3.54	1.5 0.06	111.0 4.37	108.0 4.25	0.6 0.02	1.4 0.06	97.2	64.3	0.1079	0.66 1.45
25.400 1.0000	19.845 0.7813	0.5 0.02	3.5 0.14	89.0 3.50	96.0 3.78	1.5 0.06	120.0 4.72	115.0 4.53	1.5 0.06	1.7 0.07	98.2	41.8	0.1198	1.07 2.35

<sup>(4)</sup>Negative value indicates effective center inside cone (inner-ring) backface.

<sup>(5)</sup>These maximum fillet radii will be cleared by the bearing corners.

<sup>(6)</sup>Negative value indicates cage extends beyond cone (inner-ring) backface.

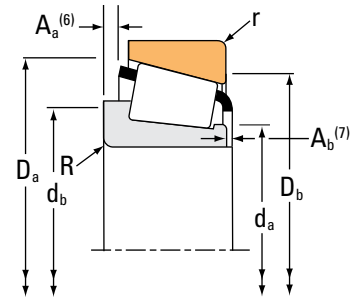
<sup>(7)</sup>Negative value indicates cage that does not extend beyond cone (inner-ring) front face.

Continued on next page.

# TAPERED ROLLER BEARINGS

## SINGLE-ROW • TYPE TS

### TYPE TS



Bearing Dimensions			Load Ratings							Part Number		
Bore d	O.D. D	Width T	Dynamic <sup>(1)</sup>		Factors <sup>(2)</sup>		Dynamic <sup>(3)</sup>		Factors <sup>(2)</sup>	Static	Inner	Outer
			C <sub>1</sub>	e	Y	C <sub>90</sub>	C <sub>a90</sub>	K	C <sub>0</sub>			
mm in.	mm in.	mm in.	N lbf			N lbf	N lbf			N lbf		
82.550 3.2500	133.350 5.2500	30.162 1.1875	154000 34700	0.44	1.35	40000 9000	30500 6850	1.31		216000 48600	495	492A
82.550 3.2500	133.350 5.2500	33.338 1.3125	214000 48100	0.40	1.48	55500 12500	38400 8640	1.44		262000 58900	47686	47620
82.550 3.2500	133.350 5.2500	33.338 1.3125	214000 48100	0.40	1.48	55500 12500	38400 8640	1.44		262000 58900	47685	47620
82.550 3.2500	133.350 5.2500	33.338 1.3125	214000 48100	0.40	1.48	55500 12500	38400 8640	1.44		262000 58900	47687	47620
82.550 3.2500	133.350 5.2500	39.688 1.5625	259000 58200	0.40	1.49	67100 15100	46200 10400	1.45		353000 79300	HM516448	HM516410
82.550 3.2500	133.350 5.2500	39.688 1.5625	259000 58200	0.40	1.49	67100 15100	46200 10400	1.45		353000 79300	HM516449C	HM516410
82.550 3.2500	133.350 5.2500	39.688 1.5625	259000 58200	0.40	1.49	67100 15100	46200 10400	1.45		353000 79300	HM516449A	HM516410
82.550 3.2500	136.525 5.3750	30.162 1.1875	154000 34700	0.44	1.35	40000 9000	30500 6850	1.31		216000 48600	495	493
82.550 3.2500	139.700 5.5000	36.512 1.4375	207000 46500	0.40	1.49	53600 12100	37100 8330	1.45		291000 65400	580	572X
82.550 3.2500	139.700 5.5000	36.512 1.4375	207000 46500	0.40	1.49	53600 12100	37100 8330	1.45		291000 65400	582	572X
82.550 3.2500	139.992 5.5115	36.512 1.4375	207000 46500	0.40	1.49	53600 12100	37100 8330	1.45		291000 65400	580	572
82.550 3.2500	139.992 5.5115	36.512 1.4375	214000 48100	0.40	1.48	55500 12500	38400 8640	1.44		262000 58900	47685	47621
82.550 3.2500	139.992 5.5115	36.512 1.4375	214000 48100	0.40	1.48	55500 12500	38400 8640	1.44		262000 58900	47686	47621
82.550 3.2500	139.992 5.5115	36.512 1.4375	207000 46500	0.40	1.49	53600 12100	37100 8330	1.45		291000 65400	582	572
82.550 3.2500	139.992 5.5115	36.512 1.4375	207000 46500	0.40	1.49	53600 12100	37100 8330	1.45		291000 65400	580	574
82.550 3.2500	139.992 5.5115	36.512 1.4375	207000 46500	0.40	1.49	53600 12100	37100 8330	1.45		291000 65400	580X	572
82.550 3.2500	142.138 5.5960	42.862 1.6875	261000 58700	0.43	1.39	67700 15200	50000 11300	1.35		399000 89700	HM617045	HM617010

<sup>(1)</sup>Based on 1 x 10<sup>6</sup> revolutions L<sub>10</sub> life, for the ISO life-calculation method.

<sup>(2)</sup>Consult your Timken engineer for instructions on use or review the Timken Engineering Manual on timken.com/catalogs.

<sup>(3)</sup>Based on 90 x 10<sup>6</sup> revolutions L<sub>10</sub> life, for The Timken Company life-calculation method. C<sub>90</sub> and C<sub>a90</sub> are radial and thrust values.

Bearing Dimensions											Geometry Factors			Bearing Weight
Width B	Width C	Eff. Ctr. a <sup>(4)</sup>	Shaft			Housing			Cage		G <sub>1</sub>	G <sub>2</sub>	C <sub>g</sub>	
			Max Shaft Fillet Radius R <sup>(5)</sup>	Backing Shoulder Dia. d <sub>a</sub> d <sub>b</sub>		Max Housing Fillet Radius r <sup>(5)</sup>	Backing Shoulder Dia. D <sub>a</sub> D <sub>b</sub>		A <sub>a</sub> <sup>(6)</sup>	A <sub>b</sub> <sup>(7)</sup>				
mm in.	mm in.	mm in.	mm in.	mm in.	mm in.	mm in.	mm in.	mm in.	mm in.	mm in.				kg lbs.
29.769 1.1720	22.225 0.8750	-0.8 -0.03	3.5 0.14	90.0 3.54	97.0 3.82	3.3 0.13	128.0 5.04	120.0 4.72	2.5 0.09	2.2 0.09	104.6	29.3	0.1252	1.49 3.30
33.338 1.3125	26.195 1.0313	-4.3 -0.17	3.5 0.14	92.0 3.62	98.0 3.86	3.3 0.13	128.0 5.04	119.0 4.69	2.3 0.09	2.4 0.10	119.4	29.2	0.1273	1.71 3.76
33.338 1.3125	26.195 1.0313	-4.3 -0.17	0.8 0.03	90.0 3.54	91.0 3.58	3.3 0.13	128.0 5.04	119.0 4.69	2.3 0.09	2.4 0.10	119.4	29.2	0.1273	1.72 3.77
33.338 1.3125	26.195 1.0313	-4.3 -0.17	6.8 0.27	92.0 3.62	105.0 4.13	3.3 0.13	128.0 5.04	119.0 4.69	2.3 0.09	2.4 0.10	119.4	29.2	0.1273	1.70 3.73
39.688 1.5625	32.545 1.2813	-7.4 -0.29	6.8 0.27	92.0 3.62	106.0 4.17	3.3 0.13	128.0 5.04	118.0 4.65	1.7 0.06	2.5 0.10	154.1	43.1	0.0955	2.14 4.72
39.688 1.5625	32.545 1.2813	-7.4 -0.29	3.5 0.14	92.0 3.62	99.0 3.90	3.3 0.13	128.0 5.04	118.0 4.65	1.7 0.06	2.5 0.10	154.1	43.1	0.0955	2.15 4.74
39.688 1.5625	32.545 1.2813	-7.4 -0.29	0.0 0.00	92.0 3.62	99.0 4.13	3.3 0.13	128.0 5.04	118.0 4.65	1.7 0.06	2.5 0.10	154.1	43.1	0.0955	2.10 4.62
29.769 1.1720	22.225 0.8750	-0.8 -0.03	3.5 0.14	90.0 3.54	97.0 3.82	3.3 0.13	130.0 5.12	122.0 4.80	2.5 0.09	2.2 0.09	104.6	29.3	0.1252	1.61 3.55
36.098 1.4212	28.575 1.1250	-5.3 -0.21	3.5 0.14	91.0 3.58	98.0 3.86	3.3 0.13	133.0 5.24	125.0 4.92	3.4 0.13	1.9 0.08	125.7	32.0	0.1295	2.12 4.69
36.098 1.4212	28.575 1.1250	-5.3 -0.21	6.8 0.27	91.0 3.58	104.0 4.09	3.3 0.13	133.0 5.24	125.0 4.92	3.4 0.13	1.9 0.08	125.7	32.0	0.1295	2.08 4.59
36.098 1.4212	28.575 1.1250	-5.3 -0.21	3.5 0.14	91.0 3.58	98.0 3.86	3.3 0.13	133.0 5.24	125.0 4.92	3.4 0.13	1.9 0.08	125.7	32.0	0.1295	2.13 4.72
33.338 1.3125	29.370 1.1563	-4.3 -0.17	0.8 0.03	90.0 3.54	91.0 3.58	3.3 0.13	130.0 5.12	122.0 4.80	2.3 0.09	2.4 0.10	119.4	29.2	0.1273	2.13 4.70
33.338 1.3125	29.370 1.1563	-4.3 -0.17	3.5 0.14	92.0 3.62	98.0 3.86	3.3 0.13	130.0 5.12	122.0 4.80	2.3 0.09	2.4 0.10	119.4	29.2	0.1273	2.12 4.69
36.098 1.4212	28.575 1.1250	-5.3 -0.21	6.8 0.27	91.0 3.58	104.0 4.09	3.3 0.13	133.0 5.24	125.0 4.92	3.4 0.13	1.9 0.08	125.7	32.0	0.1295	2.09 4.62
36.098 1.4212	28.575 1.1250	-5.3 -0.21	3.5 0.14	91.0 3.58	98.0 3.86	0.5 0.02	133.0 5.24	128.0 5.04	3.4 0.13	1.9 0.08	125.7	32.0	0.1295	2.14 4.73
36.098 1.4212	28.575 1.1250	-5.3 -0.21	4.8 0.19	92.0 3.62	100.0 3.94	3.3 0.13	133.0 5.24	125.0 4.92	3.4 0.13	1.9 0.08	125.7	32.0	0.1295	2.12 4.68
42.862 1.6875	34.133 1.3438	-7.4 -0.29	3.5 0.14	95.0 3.74	101.0 3.98	3.3 0.13	137.0 5.39	125.0 4.92	3.2 0.12	2.4 0.10	162.9	38.9	0.0996	2.76 6.09

<sup>(4)</sup>Negative value indicates effective center inside cone (inner-ring) backface.

<sup>(5)</sup>These maximum fillet radii will be cleared by the bearing corners.

<sup>(6)</sup>Negative value indicates cage extends beyond cone (inner-ring) backface.

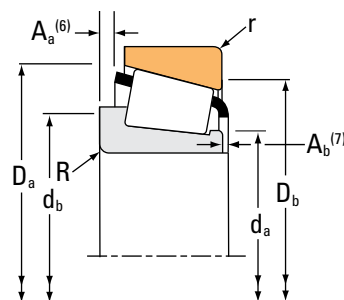
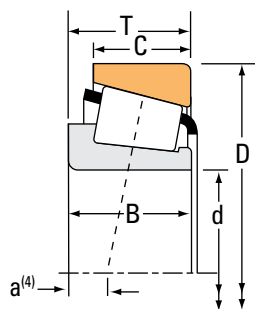
<sup>(7)</sup>Negative value indicates cage that does not extend beyond cone (inner-ring) front face.

Continued on next page.

# TAPERED ROLLER BEARINGS

## SINGLE-ROW • TYPE TS

### TYPE TS



Bearing Dimensions			Load Ratings							Part Number			
Bore d	O.D. D	Width T	Dynamic <sup>(1)</sup>		Factors <sup>(2)</sup>		Dynamic <sup>(3)</sup>		Factors <sup>(2)</sup>		Static C <sub>0</sub>	Inner	Outer
			C <sub>1</sub>	e	Y	C <sub>90</sub>	C <sub>a90</sub>	K	N	N			
mm in.	mm in.	mm in.	N lbf			N lbf	N lbf		N lbf				
82.550 3.2500	146.050 5.7500	41.275 1.6250	247000 55500	0.41	1.47	64000 14400	44800 10100	1.43	335000 75300			663	653
82.550 3.2500	146.050 5.7500	41.275 1.6250	247000 55500	0.41	1.47	64000 14400	44800 10100	1.43	335000 75300			663A	653
82.550 3.2500	147.638 5.8125	35.717 1.4062	216000 48600	0.44	1.36	56000 12600	42400 9530	1.32	319000 71600			595	592XS
82.550 3.2500	147.638 5.8125	35.717 1.4062	216000 48600	0.44	1.36	56000 12600	42400 9530	1.32	319000 71600			595	592XE
82.550 3.2500	150.000 5.9055	35.992 1.4170	216000 48600	0.44	1.36	56000 12600	42400 9530	1.32	319000 71600			595	593X
82.550 3.2500	150.089 5.9090	44.450 1.7500	377000 84700	0.33	1.84	97600 21900	54400 12200	1.80	417000 93800			749A	742
82.550 3.2500	150.089 5.9090	44.450 1.7500	377000 84700	0.33	1.84	97600 21900	54400 12200	1.80	417000 93800			750A	742
82.550 3.2500	152.400 6.0000	35.717 1.4062	216000 48600	0.44	1.36	56000 12600	42400 9530	1.32	319000 71600			595	592AS
82.550 3.2500	152.400 6.0000	39.688 1.5625	216000 48600	0.44	1.36	56000 12600	42400 9530	1.32	319000 71600			595	592A
82.550 3.2500	152.400 6.0000	41.275 1.6250	247000 55500	0.41	1.47	64000 14400	44800 10100	1.43	335000 75300			663	652
82.550 3.2500	159.995 6.2990	47.625 1.8750	327000 73600	0.34	1.76	84800 19100	49500 11100	1.71	441000 99200			757	752A
82.550 3.2500	161.925 6.3750	47.625 1.8750	327000 73600	0.34	1.76	84800 19100	49500 11100	1.71	441000 99200			757	752
82.550 3.2500	161.925 6.3750	53.975 2.1250	439000 98800	0.40	1.50	114000 25600	78100 17600	1.46	523000 118000			6559C	6535
82.550 3.2500	168.275 6.6250	47.625 1.8750	327000 73600	0.34	1.76	84800 19100	49500 11100	1.71	441000 99200			757	753
82.550 3.2500	168.275 6.6250	53.975 2.1250	409000 92000	0.30	2.00	106000 23800	54300 12200	1.95	522000 117000			839	832
82.550 3.2500	168.275 6.6250	53.975 2.1250	485000 109000	0.30	2.00	126000 28300	64400 14500	1.95	522000 117000			842	832
82.550 3.2500	180.975 7.1250	53.975 2.1250	448000 101000	0.73	0.82	116000 26100	146000 32700	0.80	458000 103000			H917849	H917810

<sup>(1)</sup>Based on  $1 \times 10^6$  revolutions  $L_{10}$  life, for the ISO life-calculation method.

<sup>(2)</sup>Consult your Timken engineer for instructions on use or review the Timken Engineering Manual on [timken.com/catalogs](http://timken.com/catalogs).

<sup>(3)</sup>Based on  $90 \times 10^6$  revolutions  $L_{10}$  life, for The Timken Company life-calculation method.  $C_{90}$  and  $C_{a90}$  are radial and thrust values.



Bearing Dimensions											Geometry Factors			Bearing Weight
Width B	Width C	Eff. Ctr. a <sup>(4)</sup>	Shaft			Housing			Cage		G <sub>1</sub>	G <sub>2</sub>	C <sub>g</sub>	
			Max Shaft Fillet Radius R <sup>(5)</sup>	Backing Shoulder Dia. d <sub>a</sub> d <sub>b</sub>		Max Housing Fillet Radius r <sup>(5)</sup>	Backing Shoulder Dia. D <sub>a</sub> D <sub>b</sub>		A <sub>a</sub> <sup>(6)</sup>	A <sub>b</sub> <sup>(7)</sup>				
mm in.	mm in.	mm in.	mm in.	mm in.	mm in.	mm in.	mm in.	mm in.	mm in.	mm in.				kg lbs.
41.275 1.6250	31.750 1.2500	-7.9 -0.31	3.5 0.14	92.0 3.62	99.0 3.90	3.3 0.13	139.0 5.47	131.0 5.16	4.5 0.17	2.1 0.08	136.6	27.3	0.0919	2.75 6.06
41.275 1.6250	31.750 1.2500	-7.9 -0.31	6.8 0.27	92.0 3.62	105.0 4.13	3.3 0.13	139.0 5.47	131.0 5.16	4.5 0.17	2.1 0.08	136.6	27.3	0.0919	2.74 6.03
36.322 1.4300	26.192 1.0312	-2.5 -0.10	3.5 0.14	93.0 3.66	100.0 3.94	3.3 0.13	142.0 5.59	133.0 5.24	4.1 0.16	1.7 0.07	151.4	38.3	0.1416	2.55 5.64
36.322 1.4300	26.192 1.0312	-2.5 -0.10	3.5 0.14	93.0 3.66	100.0 3.94	0.8 0.03	142.0 5.59	135.0 5.31	4.1 0.16	1.7 0.07	151.4	38.3	0.1416	2.57 5.68
36.322 1.4300	27.000 1.0630	-2.5 -0.10	3.5 0.14	93.0 3.66	100.0 3.94	3.0 0.12	142.0 5.59	134.0 5.28	4.1 0.16	1.7 0.07	151.4	38.3	0.1416	2.69 5.93
46.672 1.8375	36.512 1.4375	-11.9 -0.47	3.5 0.14	93.0 3.66	99.0 3.90	3.3 0.13	142.0 5.59	134.0 5.28	1.8 0.07	1.3 0.05	159.6	26.3	0.0898	3.36 7.40
46.672 1.8375	36.512 1.4375	-11.9 -0.47	6.5 0.26	93.0 3.66	106.0 4.17	3.3 0.13	142.0 5.59	134.0 5.28	1.8 0.07	1.3 0.05	159.6	26.3	0.0898	3.33 7.33
36.322 1.4300	26.192 1.0312	-2.5 -0.10	3.5 0.14	93.0 3.66	100.0 3.94	0.8 0.03	144.0 5.67	137.0 5.39	4.1 0.16	1.7 0.07	151.4	38.3	0.1416	2.81 6.19
36.322 1.4300	30.162 1.1875	-2.5 -0.10	3.5 0.14	93.0 3.66	100.0 3.94	3.3 0.13	144.0 5.67	135.0 5.31	4.1 0.16	1.7 0.07	151.4	38.3	0.1416	2.98 6.58
41.275 1.6250	31.750 1.2500	-7.9 -0.31	3.5 0.14	92.0 3.62	99.0 3.90	3.3 0.13	141.0 5.55	134.0 5.28	4.5 0.17	2.1 0.08	136.6	27.3	0.0919	3.10 6.85
48.260 1.9000	38.100 1.5000	-11.9 -0.47	3.5 0.14	94.0 3.70	100.0 3.94	0.8 0.03	150.0 5.91	146.0 5.75	3.2 0.12	1.0 0.04	177.2	29.4	0.0945	4.27 9.41
48.260 1.9000	38.100 1.5000	-11.9 -0.47	3.5 0.14	94.0 3.70	100.0 3.94	3.3 0.13	150.0 5.91	144.0 5.67	3.2 0.12	1.0 0.04	177.2	29.4	0.0945	4.39 9.69
55.100 2.1693	42.862 1.6875	-13.2 -0.52	3.5 0.14	98.0 3.86	104.0 4.09	3.3 0.13	154.0 6.06	141.0 5.55	4.1 0.16	0.9 0.04	198.6	33.5	0.1037	5.07 11.18
48.260 1.9000	38.100 1.5000	-11.9 -0.47	3.5 0.14	94.0 3.70	100.0 3.94	3.3 0.13	150.0 5.91	147.0 5.79	3.2 0.12	1.0 0.04	177.2	29.4	0.0945	4.86 10.73
56.363 2.2190	41.275 1.6250	-18.5 -0.73	0.8 0.03	94.0 3.70	95.0 3.74	3.3 0.13	155.0 6.10	149.0 5.87	5.2 0.20	1.6 0.07	197.9	34.8	0.0937	5.44 11.98
56.363 2.2190	41.275 1.6250	-18.5 -0.73	3.5 0.14	94.0 3.70	101.0 3.98	3.3 0.13	155.0 6.10	149.0 5.87	5.2 0.20	1.6 0.07	197.9	34.8	0.0937	5.42 11.95
53.183 2.0938	35.720 1.4063	0.5 0.02	3.3 0.13	100.1 3.94	114.0 4.49	3.3 0.13	170.0 6.69	152.0 5.98	9.5 0.37	2.8 0.11	147.0	20.7	0.1123	6.23 13.72

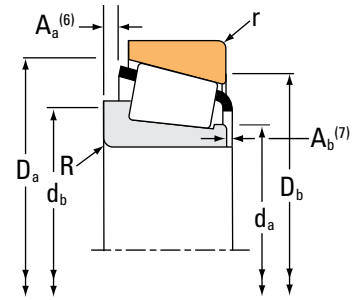
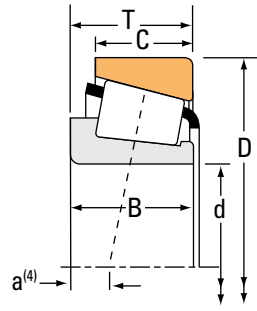
<sup>(4)</sup>Negative value indicates effective center inside cone (inner-ring) backface.  
<sup>(5)</sup>These maximum fillet radii will be cleared by the bearing corners.  
<sup>(6)</sup>Negative value indicates cage extends beyond cone (inner-ring) backface.  
<sup>(7)</sup>Negative value indicates cage that does not extend beyond cone (inner-ring) front face.

Continued on next page.

# TAPERED ROLLER BEARINGS

## SINGLE-ROW • TYPE TS

### TYPE TS



Bearing Dimensions			Load Ratings							Part Number		
Bore d	O.D. D	Width T	Dynamic <sup>(1)</sup> C <sub>1</sub>		Factors <sup>(2)</sup> e Y		Dynamic <sup>(3)</sup> C <sub>90</sub> C <sub>a90</sub>		Factors <sup>(2)</sup> K	Static C <sub>0</sub>	Inner	Outer
mm in.	mm in.	mm in.	N lbf				N lbf	N lbf		N lbf		
83.345 3.2813	125.412 4.9375	25.400 1.0000	117000 26300	0.42	1.44		30400 6830	21600 4860	1.40	178000 39900	27690	27620
83.345 3.2813	125.412 4.9375	25.400 1.0000	117000 26300	0.42	1.44		30400 6830	21600 4860	1.40	178000 39900	27689	27620
83.345 3.2813	125.412 4.9375	25.400 1.0000	117000 26300	0.42	1.44		30400 6830	21600 4860	1.40	178000 39900	27691	27620
83.345 3.2813	133.350 5.2500	33.338 1.3125	214000 48100	0.40	1.48		55500 12500	38400 8640	1.44	262000 58900	47688	47620
84.138 3.3125	133.350 5.2500	30.162 1.1875	154000 34700	0.44	1.35		40000 9000	30500 6850	1.31	216000 48600	498	492A
84.138 3.3125	136.525 5.3750	30.162 1.1875	154000 34700	0.44	1.35		40000 9000	30500 6850	1.31	216000 48600	498	493
84.138 3.3125	152.400 6.0000	41.275 1.6250	247000 55500	0.41	1.47		64000 14400	44800 10100	1.43	335000 75300	664	652
84.138 3.3125	171.450 6.7500	49.212 1.9375	363000 81600	0.76	0.79		94100 21200	123000 27700	0.76	351000 78800	9386H	9321
84.138 3.3125	177.800 7.0000	52.388 2.0625	363000 81600	0.76	0.79		94100 21200	123000 27700	0.76	351000 78800	9386H	9320
84.975 3.3455	125.412 4.9375	25.400 1.0000	117000 26300	0.42	1.44		30400 6830	21600 4860	1.40	178000 39900	27695	27620
85.000 3.3465	130.000 5.1181	30.000 1.1811	161000 36300	0.44	1.35		41800 9400	31800 7150	1.31	245000 55100	JM716649	JM716610
85.000 3.3465	130.000 5.1181	30.000 1.1811	161000 36300	0.44	1.35		41800 9400	31800 7150	1.31	245000 55100	JM716648	JM716610
85.000 3.3465	140.000 5.5118	39.000 1.5354	238000 53400	0.41	1.47		61600 13800	42900 9650	1.43	339000 76300	JHM516849	JHM516810
85.000 3.3465	146.050 5.7500	41.275 1.6250	247000 55500	0.41	1.47		64000 14400	44800 10100	1.43	335000 75300	665X	653
85.000 3.3465	150.000 5.9055	41.275 1.6250	247000 55500	0.41	1.47		64000 14400	44800 10100	1.43	335000 75300	665X	653X
85.000 3.3465	150.000 5.9055	46.000 1.8110	332000 74600	0.33	1.80		86000 19300	49000 11000	1.76	446000 100000	JH217249	JH217210
85.000 3.3465	188.912 7.4375	53.297 2.0983	383000 86100	0.87	0.69		99300 22300	147000 33100	0.67	392000 88100	90334	90744

<sup>(1)</sup>Based on 1 x 10<sup>6</sup> revolutions L<sub>10</sub> life, for the ISO life-calculation method.

<sup>(2)</sup>Consult your Timken engineer for instructions on use or review the Timken Engineering Manual on timken.com/catalogs.

<sup>(3)</sup>Based on 90 x 10<sup>6</sup> revolutions L<sub>10</sub> life, for The Timken Company life-calculation method. C<sub>90</sub> and C<sub>a90</sub> are radial and thrust values.

Bearing Dimensions											Geometry Factors			Bearing Weight
Width B	Width C	Eff. Ctr. a <sup>(4)</sup>	Shaft			Housing			Cage		G <sub>1</sub>	G <sub>2</sub>	C <sub>g</sub>	
			Max Shaft Fillet Radius R <sup>(5)</sup>	Backing Shoulder Dia. d <sub>a</sub>	Shoulder Dia. d <sub>b</sub>	Max Housing Fillet Radius r <sup>(5)</sup>	Backing Shoulder Dia. D <sub>a</sub>	Shoulder Dia. D <sub>b</sub>	A <sub>a</sub> <sup>(6)</sup>	A <sub>b</sub> <sup>(7)</sup>				
mm in.	mm in.	mm in.	mm in.	mm in.	mm in.	mm in.	mm in.	mm in.	mm in.	mm in.				kg lbs.
25.400 1.0000	19.845 0.7813	0.5 0.02	3.5 0.14	89.0 3.50	96.0 3.78	1.5 0.06	120.0 4.72	115.0 4.53	1.5 0.06	1.7 0.07	98.2	41.8	0.1198	1.05 2.30
25.400 1.0000	19.845 0.7813	0.5 0.02	0.8 0.03	90.0 3.54	90.0 3.54	1.5 0.06	120.0 4.72	115.0 4.53	1.5 0.06	1.7 0.07	98.2	41.8	0.1198	1.05 2.32
25.400 1.0000	19.845 0.7813	0.5 0.02	6.4 0.25	90.0 3.54	102.0 4.02	1.5 0.06	120.0 4.72	115.0 4.53	1.5 0.06	1.7 0.07	98.2	41.8	0.1198	1.01 2.22
33.338 1.3125	26.195 1.0313	-4.3 -0.17	3.5 0.14	91.0 3.58	97.0 3.82	3.3 0.13	128.0 5.04	119.0 4.69	2.3 0.09	2.4 0.10	119.4	29.2	0.1273	1.68 3.69
29.769 1.1720	22.225 0.8750	-0.8 -0.03	3.5 0.14	91.0 3.58	98.0 3.86	3.3 0.13	128.0 5.04	120.0 4.72	2.5 0.09	2.2 0.09	104.6	29.3	0.1252	1.44 3.19
29.769 1.1720	22.225 0.8750	-0.8 -0.03	3.5 0.14	91.0 3.58	98.0 3.86	3.3 0.13	130.0 5.12	122.0 4.80	2.5 0.09	2.2 0.09	104.6	29.3	0.1252	1.56 3.45
41.275 1.6250	31.750 1.2500	-7.9 -0.31	3.5 0.14	94.0 3.70	100.0 3.94	3.3 0.13	141.0 5.55	134.0 5.28	4.5 0.17	2.1 0.08	136.6	27.3	0.0919	3.04 6.70
46.038 1.8125	31.750 1.2500	4.3 0.17	3.5 0.14	98.3 3.87	111.0 4.37	3.3 0.13	164.0 6.46	147.0 5.79	8.9 0.35	3.9 0.16	117.9	18.6	0.1053	4.70 10.36
46.038 1.8125	34.925 1.3750	4.3 0.17	3.5 0.14	98.3 3.87	111.0 4.37	3.3 0.13	164.0 6.46	148.0 5.83	8.9 0.35	3.9 0.16	117.9	18.6	0.1053	5.40 11.91
25.400 1.0000	19.845 0.7813	0.5 0.02	5.0 0.20	91.0 3.58	100.0 3.94	1.5 0.06	120.0 4.72	115.0 4.53	1.5 0.06	1.7 0.07	98.2	41.8	0.1198	0.98 2.16
29.000 1.1417	24.000 0.9449	-0.3 -0.01	3.0 0.12	92.0 3.62	98.0 3.86	2.5 0.10	125.0 4.92	117.0 4.61	2.0 0.08	2.6 0.10	117.1	38.4	0.1303	1.36 3.00
29.000 1.1417	24.000 0.9449	-0.3 -0.01	6.0 0.24	92.0 3.62	104.0 4.09	2.5 0.10	125.0 4.92	117.0 4.61	2.0 0.08	2.6 0.10	117.1	38.4	0.1303	1.32 2.91
38.000 1.4961	31.500 1.2402	-5.8 -0.23	3.0 0.12	94.0 3.70	100.0 3.94	2.5 0.10	134.0 5.28	125.0 4.92	1.4 0.05	3.6 0.14	140.9	35.2	0.0929	2.27 5.00
41.275 1.6250	31.750 1.2500	-7.9 -0.31	3.5 0.14	95.0 3.74	101.0 3.98	3.3 0.13	139.0 5.47	131.0 5.16	4.5 0.17	2.1 0.08	136.6	27.3	0.0919	2.65 5.83
41.275 1.6250	31.750 1.2500	-7.9 -0.31	3.5 0.14	95.0 3.74	101.0 3.98	3.0 0.12	141.0 5.55	133.0 5.24	4.5 0.17	2.1 0.08	136.6	27.3	0.0919	2.86 6.31
46.000 1.8110	38.000 1.4961	-11.9 -0.47	3.0 0.12	95.0 3.74	101.0 3.98	2.5 0.10	142.0 5.59	134.0 5.28	1.1 0.04	3.5 0.14	169.3	33.3	0.0924	3.34 7.36
52.761 2.0772	31.750 1.2500	10.4 0.41	3.5 0.14	112.0 4.41	116.0 4.57	3.3 0.13	179.0 7.06	161.0 6.34	13.5 0.53	-0.5 -0.02	149.6	23.8	0.1180	6.57 14.48

<sup>(4)</sup>Negative value indicates effective center inside cone (inner-ring) backface.

<sup>(5)</sup>These maximum fillet radii will be cleared by the bearing corners.

<sup>(6)</sup>Negative value indicates cage extends beyond cone (inner-ring) backface.

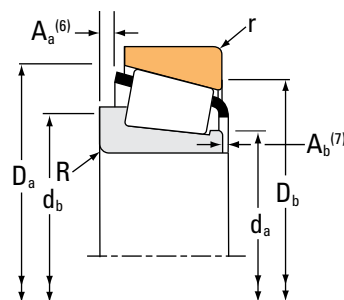
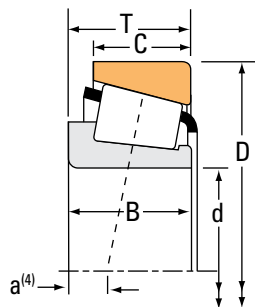
<sup>(7)</sup>Negative value indicates cage that does not extend beyond cone (inner-ring) front face.

Continued on next page.

# TAPERED ROLLER BEARINGS

## SINGLE-ROW • TYPE TS

### TYPE TS



Bearing Dimensions			Load Ratings							Part Number		
Bore d	O.D. D	Width T	Dynamic <sup>(1)</sup> C <sub>1</sub>		Factors <sup>(2)</sup> e Y		Dynamic <sup>(3)</sup> C <sub>90</sub> C <sub>a90</sub>		Factors <sup>(2)</sup> K	Static C <sub>0</sub>	Inner	Outer
mm in.	mm in.	mm in.	N lbf				N lbf	N lbf		N lbf		
85.000 3.3465	200.000 7.8740	52.761 2.0772	482000 108000	0.63	0.95		125000 28100	135000 30400	0.92	519000 117000	98335	98788
85.025 3.3475	150.000 5.9055	44.455 1.7502	377000 84700	0.33	1.84		97600 21900	54400 12200	1.80	417000 93800	749	743
85.025 3.3475	150.089 5.9090	44.450 1.7500	377000 84700	0.33	1.84		97600 21900	54400 12200	1.80	417000 93800	749	742
85.025 3.3475	150.089 5.9090	44.450 1.7500	377000 84700	0.33	1.84		97600 21900	54400 12200	1.80	417000 93800	749-S	742
85.725 3.3750	133.350 5.2500	30.162 1.1875	154000 34700	0.44	1.35		40000 9000	30500 6850	1.31	216000 48600	497	492A
85.725 3.3750	136.525 5.3750	30.162 1.1875	154000 34700	0.44	1.35		40000 9000	30500 6850	1.31	216000 48600	497	493
85.725 3.3750	136.525 5.3750	30.162 1.1875	154000 34700	0.44	1.35		40000 9000	30500 6850	1.31	216000 48600	497A	493
85.725 3.3750	142.138 5.5960	42.862 1.6875	261000 58700	0.43	1.39		67700 15200	50000 11300	1.35	399000 89700	HM617049	HM617010
85.725 3.3750	142.138 5.5960	42.862 1.6875	261000 58700	0.43	1.39		67700 15200	50000 11300	1.35	399000 89700	HM617048	HM617010
85.725 3.3750	146.050 5.7500	41.275 1.6250	247000 55500	0.41	1.47		64000 14400	44800 10100	1.43	335000 75300	665	653
85.725 3.3750	146.050 5.7500	41.275 1.6250	247000 55500	0.41	1.47		64000 14400	44800 10100	1.43	335000 75300	665A	653
85.725 3.3750	147.828 5.8200	35.717 1.4062	216000 48600	0.44	1.36		56000 12600	42400 9530	1.32	319000 71600	596	592AX
85.725 3.3750	150.000 5.9055	35.966 1.4160	216000 48600	0.44	1.36		56000 12600	42400 9530	1.32	319000 71600	596	JM719113
85.725 3.3750	150.000 5.9055	35.992 1.4170	216000 48600	0.44	1.36		56000 12600	42400 9530	1.32	319000 71600	596	593X
85.725 3.3750	152.400 6.0000	39.688 1.5625	216000 48600	0.44	1.36		56000 12600	42400 9530	1.32	319000 71600	596	592A
85.725 3.3750	152.400 6.0000	41.275 1.6250	247000 55500	0.41	1.47		64000 14400	44800 10100	1.43	335000 75300	665	652
85.725 3.3750	161.925 6.3750	47.625 1.8750	327000 73600	0.34	1.76		84800 19100	49500 11100	1.71	441000 99200	758	752

<sup>(1)</sup>Based on 1 x 10<sup>6</sup> revolutions L<sub>10</sub> life, for the ISO life-calculation method.

<sup>(2)</sup>Consult your Timken engineer for instructions on use or review the Timken Engineering Manual on timken.com/catalogs.

<sup>(3)</sup>Based on 90 x 10<sup>6</sup> revolutions L<sub>10</sub> life, for The Timken Company life-calculation method. C<sub>90</sub> and C<sub>a90</sub> are radial and thrust values.

Bearing Dimensions											Geometry Factors			Bearing Weight
Width B	Width C	Eff. Ctr. a <sup>(4)</sup>	Shaft			Housing			Cage		G <sub>1</sub>	G <sub>2</sub>	C <sub>g</sub>	
			Max Shaft Fillet Radius R <sup>(5)</sup>	Backing Shoulder Dia. d <sub>a</sub>	mm in.	Max Housing Fillet Radius r <sup>(5)</sup>	Backing Shoulder Dia. D <sub>a</sub>	mm in.	A <sub>a</sub> <sup>(6)</sup>	A <sub>b</sub> <sup>(7)</sup>				
mm in.	mm in.	mm in.	mm in.	mm in.	mm in.	mm in.	mm in.	mm in.	mm in.	mm in.			kg lbs.	
49.212 1.9375	34.925 1.3750	1.3 0.05	3.5 0.14	109.0 4.29	115.0 4.53	3.3 0.13	188.0 7.40	174.0 6.85	8.6 0.34	5.4 0.22	203.4	37.5	0.1197	7.69 16.96
46.672 1.8375	35.000 1.3780	-11.9 -0.47	3.5 0.14	95.0 3.74	101.0 3.98	3.3 0.13	142.0 5.59	134.0 5.28	1.8 0.07	1.3 0.05	159.6	26.3	0.0898	3.21 7.06
46.672 1.8375	36.512 1.4375	-11.9 -0.47	3.5 0.14	95.0 3.74	101.0 3.98	3.3 0.13	142.0 5.59	134.0 5.28	1.8 0.07	1.3 0.05	159.6	26.3	0.0898	3.26 7.16
46.672 1.8375	36.512 1.4375	-11.9 -0.47	5.0 0.20	95.0 3.74	104.0 4.09	3.3 0.13	142.0 5.59	134.0 5.28	1.8 0.07	1.3 0.05	159.6	26.3	0.0898	3.23 7.11
29.769 1.1720	22.225 0.8750	-0.8 -0.03	3.5 0.14	93.0 3.66	99.0 3.90	3.3 0.13	128.0 5.04	120.0 4.72	2.5 0.09	2.2 0.09	104.6	29.3	0.1252	1.39 3.08
29.769 1.1720	22.225 0.8750	-0.8 -0.03	3.5 0.14	93.0 3.66	99.0 3.90	3.3 0.13	130.0 5.12	122.0 4.80	2.5 0.09	2.2 0.09	104.6	29.3	0.1252	1.51 3.34
29.769 1.1720	22.225 0.8750	-0.8 -0.03	6.4 0.25	93.0 3.66	105.0 4.13	3.3 0.13	130.0 5.12	122.0 4.80	2.5 0.09	2.2 0.09	104.6	29.3	0.1252	1.48 3.27
42.862 1.6875	34.133 1.3438	-7.4 -0.29	4.8 0.19	95.2 3.75	106.0 4.17	3.3 0.13	137.0 5.39	125.0 4.92	3.2 0.12	2.4 0.10	162.9	38.9	0.0996	2.61 5.75
42.862 1.6875	34.133 1.3438	-7.4 -0.29	1.5 0.06	95.2 3.75	99.0 3.90	3.3 0.13	137.0 5.39	125.0 4.92	3.2 0.12	2.4 0.10	162.9	38.9	0.0996	2.63 5.80
41.275 1.6250	31.750 1.2500	-7.9 -0.31	3.5 0.14	95.0 3.74	102.0 4.02	3.3 0.13	139.0 5.47	131.0 5.16	4.5 0.17	2.1 0.08	136.6	27.3	0.0919	2.61 5.75
41.275 1.6250	31.750 1.2500	-7.9 -0.31	6.4 0.25	95.0 3.74	107.0 4.21	3.3 0.13	139.0 5.47	131.0 5.16	4.5 0.17	2.1 0.08	136.6	27.3	0.0919	2.58 5.68
36.322 1.4300	26.192 1.0312	-2.5 -0.10	3.5 0.14	96.0 3.78	102.0 4.02	3.3 0.13	142.0 5.59	133.0 5.24	4.1 0.16	1.7 0.07	151.4	38.3	0.1416	2.47 5.45
36.322 1.4300	27.000 1.0630	-2.5 -0.10	3.5 0.14	96.0 3.78	102.0 4.02	2.5 0.10	143.0 5.63	135.0 5.31	4.1 0.16	1.7 0.07	151.4	38.3	0.1416	2.57 5.68
36.322 1.4300	27.000 1.0630	-2.5 -0.10	3.5 0.14	96.0 3.78	102.0 4.02	3.0 0.12	142.0 5.59	134.0 5.28	4.1 0.16	1.7 0.07	151.4	38.3	0.1416	2.57 5.67
36.322 1.4300	30.162 1.1875	-2.5 -0.10	3.5 0.14	96.0 3.78	102.0 4.02	3.3 0.13	144.0 5.67	135.0 5.31	4.1 0.16	1.7 0.07	151.4	38.3	0.1416	2.86 6.32
41.275 1.6250	31.750 1.2500	-7.9 -0.31	3.5 0.14	95.0 3.74	102.0 4.02	3.3 0.13	141.0 5.55	134.0 5.28	4.5 0.17	2.1 0.08	136.6	27.3	0.0919	2.96 6.54
48.260 1.9000	38.100 1.5000	-11.9 -0.47	3.5 0.14	100.0 3.94	106.0 4.17	3.3 0.13	150.0 5.91	144.0 5.67	3.2 0.12	1.0 0.04	177.2	29.4	0.0945	4.24 9.35

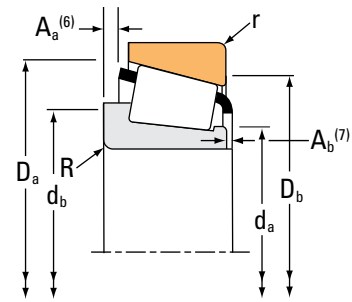
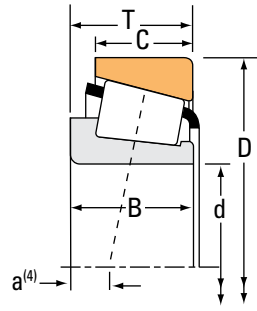
<sup>(4)</sup>Negative value indicates effective center inside cone (inner-ring) backface.  
<sup>(5)</sup>These maximum fillet radii will be cleared by the bearing corners.  
<sup>(6)</sup>Negative value indicates cage extends beyond cone (inner-ring) backface.  
<sup>(7)</sup>Negative value indicates cage that does not extend beyond cone (inner-ring) front face.

Continued on next page.

# TAPERED ROLLER BEARINGS

## SINGLE-ROW • TYPE TS

### TYPE TS



Bearing Dimensions			Load Ratings							Part Number		
Bore d	O.D. D	Width T	Dynamic <sup>(1)</sup>		Factors <sup>(2)</sup>		Dynamic <sup>(3)</sup>		Factors <sup>(2)</sup>	Static	Inner	Outer
			C <sub>1</sub>	e	Y	C <sub>90</sub>	C <sub>a90</sub>	K	C <sub>0</sub>			
mm in.	mm in.	mm in.	N lbf			N lbf	N lbf			N lbf		
85.725 3.3750	168.275 6.6250	41.275 1.6250	265000 59500	0.47	1.28	68600 15400	55300 12400	1.24		386000 86700	677	672
85.725 3.3750	168.275 6.6250	53.975 2.1250	485000 109000	0.30	2.00	126000 28300	64400 14500	1.95		522000 117000	841	832
87.312 3.4375	123.825 4.8750	20.638 0.8125	92600 20800	0.33	1.82	24000 5400	13600 3050	1.77		156000 35200	L217847	L217810
87.312 3.4375	152.400 6.0000	39.688 1.5625	216000 48600	0.44	1.36	56000 12600	42400 9530	1.32		319000 71600	596-S	592A
87.312 3.4375	190.500 7.5000	57.150 2.2500	534000 120000	0.33	1.79	138000 31100	79300 17800	1.74		692000 156000	HH221432	HH221410
87.960 3.4630	148.430 5.8437	28.575 1.1250	193000 43400	0.49	1.22	50100 11300	42200 9480	1.19		241000 54300	42346	42584
87.960 3.4630	149.225 5.8750	31.750 1.2500	193000 43400	0.49	1.22	50100 11300	42200 9480	1.19		241000 54300	42346	42587
88.900 3.5000	121.442 4.7812	15.083 0.5938	59500 13400	0.33	1.81	15400 3470	8730 1960	1.77		88700 20000	LL217849	LL217810
88.900 3.5000	123.825 4.8750	20.638 0.8125	92600 20800	0.33	1.82	24000 5400	13600 3050	1.77		156000 35200	L217849	L217810
88.900 3.5000	127.000 5.0000	20.638 0.8125	92600 20800	0.33	1.82	24000 5400	13600 3050	1.77		156000 35200	L217849	L217813
88.900 3.5000	148.430 5.8437	28.575 1.1250	193000 43400	0.49	1.22	50100 11300	42200 9480	1.19		241000 54300	42350	42584
88.900 3.5000	149.225 5.8750	31.750 1.2500	193000 43400	0.49	1.22	50100 11300	42200 9480	1.19		241000 54300	42350	42587
88.900 3.5000	150.000 5.9055	35.966 1.4160	216000 48600	0.44	1.36	56000 12600	42400 9530	1.32		319000 71600	593A	JM719113
88.900 3.5000	150.000 5.9055	35.966 1.4160	216000 48600	0.44	1.36	56000 12600	42400 9530	1.32		319000 71600	593	JM719113
88.900 3.5000	150.000 5.9055	35.992 1.4170	216000 48600	0.44	1.36	56000 12600	42400 9530	1.32		319000 71600	593	593X
88.900 3.5000	152.400 6.0000	39.688 1.5625	216000 48600	0.44	1.36	56000 12600	42400 9530	1.32		319000 71600	593	592A
88.900 3.5000	152.400 6.0000	39.688 1.5625	216000 48600	0.44	1.36	56000 12600	42400 9530	1.32		319000 71600	593A	592A

<sup>(1)</sup>Based on 1 x 10<sup>6</sup> revolutions L<sub>10</sub> life, for the ISO life-calculation method.

<sup>(2)</sup>Consult your Timken engineer for instructions on use or review the Timken Engineering Manual on timken.com/catalogs.

<sup>(3)</sup>Based on 90 x 10<sup>6</sup> revolutions L<sub>10</sub> life, for The Timken Company life-calculation method. C<sub>90</sub> and C<sub>a90</sub> are radial and thrust values.

Bearing Dimensions											Geometry Factors			Bearing Weight
Width B	Width C	Eff. Ctr. a <sup>(4)</sup>	Shaft			Housing			Cage		G <sub>1</sub>	G <sub>2</sub>	C <sub>g</sub>	
			Max Shaft Fillet Radius R <sup>(5)</sup>	Backing Shoulder Dia. d <sub>a</sub>	Backing Shoulder Dia. d <sub>b</sub>	Max Housing Fillet Radius r <sup>(5)</sup>	Backing Shoulder Dia. D <sub>a</sub>	Backing Shoulder Dia. D <sub>b</sub>	A <sub>a</sub> <sup>(6)</sup>	A <sub>b</sub> <sup>(7)</sup>				
mm in.	mm in.	mm in.	mm in.	mm in.	mm in.	mm in.	mm in.	mm in.	mm in.	mm in.				kg lbs.
41.275 1.6250	30.162 1.1875	-2.8 -0.11	3.5 0.14	99.0 3.90	105.0 4.13	3.3 0.13	160.0 6.30	149.0 5.87	4.9 0.19	2.1 0.08	182.5	37.3	0.1056	4.14 9.11
56.363 2.2190	41.275 1.6250	-18.5 -0.73	3.5 0.14	97.0 3.82	104.0 4.09	3.3 0.13	155.0 6.10	149.0 5.87	5.2 0.20	1.6 0.07	197.9	34.8	0.0937	5.24 11.54
20.638 0.8125	16.670 0.6563	0.0 0.00	1.5 0.06	93.0 3.66	96.0 3.78	1.5 0.06	119.0 4.69	116.0 4.57	0.4 0.01	2.1 0.09	111.3	74.8	0.1152	0.78 1.70
36.322 1.4300	30.162 1.1875	-2.5 -0.10	3.5 0.14	97.0 3.82	103.0 4.06	3.3 0.13	144.0 5.67	135.0 5.31	4.1 0.16	1.7 0.07	151.4	38.3	0.1416	2.80 6.18
57.531 2.2650	46.038 1.8125	-15.0 -0.59	8.0 0.31	103.0 4.06	118.0 4.65	3.3 0.13	179.0 7.05	171.0 6.73	2.5 0.10	3.2 0.13	265.6	28.4	0.1072	7.90 17.41
28.971 1.1406	21.433 0.8438	3.0 0.12	3.0 0.12	98.0 3.86	103.0 4.06	3.0 0.12	142.0 5.59	134.0 5.28	2.8 0.11	3.0 0.12	129.7	37.2	0.1386	1.96 4.32
28.971 1.1406	24.608 0.9688	3.0 0.12	3.0 0.12	98.0 3.86	103.0 4.06	3.3 0.13	142.0 5.59	134.0 5.28	2.8 0.11	3.0 0.12	129.7	37.2	0.1386	2.11 4.66
15.083 0.5938	11.112 0.4375	3.0 0.12	1.5 0.06	94.0 3.70	97.0 3.82	1.5 0.06	117.0 4.61	115.0 4.53	0.4 0.01	2.1 0.08	73.4	74.1	0.0996	0.48 1.04
20.638 0.8125	16.670 0.6563	0.0 0.00	1.5 0.06	94.0 3.70	97.0 3.82	1.5 0.06	119.0 4.69	116.0 4.57	0.4 0.01	2.1 0.09	111.3	74.8	0.1152	0.74 1.63
20.638 0.8125	19.050 0.7500	0.0 0.00	1.5 0.06	94.0 3.70	97.0 3.82	1.5 0.06	121.0 4.76	117.0 4.61	0.4 0.01	2.1 0.09	111.3	74.8	0.1152	0.85 1.88
28.971 1.1406	21.433 0.8438	3.0 0.12	3.0 0.12	98.0 3.86	104.0 4.09	3.0 0.12	142.0 5.59	134.0 5.28	2.8 0.11	3.0 0.12	129.7	37.2	0.1386	1.93 4.25
28.971 1.1406	24.608 0.9688	3.0 0.12	3.0 0.12	98.0 3.86	104.0 4.09	3.3 0.13	142.0 5.59	134.0 5.28	2.8 0.11	3.0 0.12	129.7	37.2	0.1386	2.08 4.59
36.322 1.4300	27.000 1.0630	-2.5 -0.10	6.4 0.25	98.0 3.86	110.0 4.33	2.5 0.10	143.0 5.63	135.0 5.31	4.1 0.16	1.7 0.07	151.4	38.3	0.1416	2.42 5.34
36.322 1.4300	27.000 1.0630	-2.5 -0.10	3.5 0.14	98.0 3.86	104.0 4.09	2.5 0.10	143.0 5.63	135.0 5.31	4.1 0.16	1.7 0.07	151.4	38.3	0.1416	2.45 5.41
36.322 1.4300	27.000 1.0630	-2.5 -0.10	3.5 0.14	98.0 3.86	104.0 4.09	3.0 0.12	142.0 5.59	134.0 5.28	4.1 0.16	1.7 0.07	151.4	38.3	0.1416	2.45 5.40
36.322 1.4300	30.162 1.1875	-2.5 -0.10	3.5 0.14	98.0 3.86	104.0 4.09	3.3 0.13	144.0 5.67	135.0 5.31	4.1 0.16	1.7 0.07	151.4	38.3	0.1416	2.74 6.04
36.322 1.4300	30.162 1.1875	-2.5 -0.10	6.4 0.25	98.0 3.86	110.0 4.33	3.3 0.13	144.0 5.67	135.0 5.31	4.1 0.16	1.7 0.07	151.4	38.3	0.1416	2.71 5.97

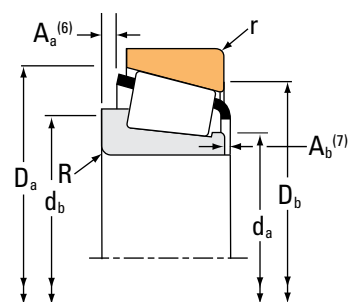
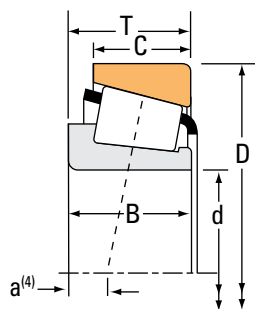
(4) Negative value indicates effective center inside cone (inner-ring) backface.  
 (5) These maximum fillet radii will be cleared by the bearing corners.  
 (6) Negative value indicates cage extends beyond cone (inner-ring) backface.  
 (7) Negative value indicates cage that does not extend beyond cone (inner-ring) front face.

Continued on next page.

# TAPERED ROLLER BEARINGS

## SINGLE-ROW • TYPE TS

### TYPE TS



Bearing Dimensions			Load Ratings							Part Number			
Bore d	O.D. D	Width T	Dynamic <sup>(1)</sup>		Factors <sup>(2)</sup>		Dynamic <sup>(3)</sup>		Factors <sup>(2)</sup>		Static C <sub>0</sub>	Inner	Outer
			C <sub>1</sub>	e	Y	C <sub>90</sub>	C <sub>a90</sub>	K	N	N			
mm in.	mm in.	mm in.	N lbf			N lbf	N lbf		N lbf				
88.900 3.5000	152.400 6.0000	39.688 1.5625	297000 66700	0.40	1.49	76900 17300	52900 11900	1.45	404000 90800			HM518445	HM518410
88.900 3.5000	159.995 6.2990	47.625 1.8750	327000 73600	0.34	1.76	84800 19100	49500 11100	1.71	441000 99200			759	752A
88.900 3.5000	160.000 6.2992	53.975 2.1250	439000 98800	0.40	1.50	114000 25600	78100 17600	1.46	523000 118000			6580	6525X
88.900 3.5000	161.925 6.3750	47.625 1.8750	327000 73600	0.34	1.76	84800 19100	49500 11100	1.71	441000 99200			759	752
88.900 3.5000	161.925 6.3750	47.625 1.8750	327000 73600	0.34	1.76	84800 19100	49500 11100	1.71	441000 99200			766	752
88.900 3.5000	161.925 6.3750	53.975 2.1250	439000 98800	0.40	1.50	114000 25600	78100 17600	1.46	523000 118000			6580	6535
88.900 3.5000	161.925 6.3750	53.975 2.1250	439000 98800	0.40	1.50	114000 25600	78100 17600	1.46	523000 118000			6580	6536
88.900 3.5000	168.275 6.6250	41.275 1.6250	265000 59500	0.47	1.28	68600 15400	55300 12400	1.24	386000 86700			679	672
88.900 3.5000	168.275 6.6250	47.625 1.8750	327000 73600	0.34	1.76	84800 19100	49500 11100	1.71	441000 99200			759	753
88.900 3.5000	168.275 6.6250	47.625 1.8750	327000 73600	0.34	1.76	84800 19100	49500 11100	1.71	441000 99200			766	753
88.900 3.5000	168.275 6.6250	53.975 2.1250	485000 109000	0.30	2.00	126000 28300	64400 14500	1.95	522000 117000			850	832
88.900 3.5000	171.450 6.7500	47.625 1.8750	340000 76400	0.37	1.63	88100 19800	55300 12400	1.59	474000 107000			77350	77675
88.900 3.5000	180.975 7.1250	47.625 1.8750	346000 77800	0.39	1.56	89700 20200	59200 13300	1.51	495000 111000			775	772
88.900 3.5000	190.500 7.5000	57.150 2.2500	458000 103000	0.33	1.79	119000 26700	68000 15300	1.74	630000 142000			855	854
88.900 3.5000	190.500 7.5000	57.150 2.2500	534000 120000	0.33	1.79	138000 31100	79300 17800	1.74	692000 156000			HH221434	HH221410
88.900 3.5000	200.000 7.8740	52.761 2.0772	482000 108000	0.63	0.95	125000 28100	135000 30400	0.92	519000 117000			98350	98788
89.090 3.5075	147.638 5.8125	35.717 1.4062	216000 48600	0.44	1.36	56000 12600	42400 9530	1.32	319000 71600			593-S	592XE

<sup>(1)</sup>Based on 1 x 10<sup>6</sup> revolutions L<sub>10</sub> life, for the ISO life-calculation method.

<sup>(2)</sup>Consult your Timken engineer for instructions on use or review the Timken Engineering Manual on timken.com/catalogs.

<sup>(3)</sup>Based on 90 x 10<sup>6</sup> revolutions L<sub>10</sub> life, for The Timken Company life-calculation method. C<sub>90</sub> and C<sub>a90</sub> are radial and thrust values.



Bearing Dimensions											Geometry Factors			Bearing Weight
Width B	Width C	Eff. Ctr. a <sup>(4)</sup>	Shaft			Housing			Cage		G <sub>1</sub>	G <sub>2</sub>	C <sub>g</sub>	
			Max Shaft Fillet Radius R <sup>(5)</sup>	Backing Shoulder Dia. d <sub>a</sub>	Backing Shoulder Dia. d <sub>b</sub>	Max Housing Fillet Radius r <sup>(5)</sup>	Backing Shoulder Dia. D <sub>a</sub>	Backing Shoulder Dia. D <sub>b</sub>	A <sub>a</sub> <sup>(6)</sup>	A <sub>b</sub> <sup>(7)</sup>				
mm in.	mm in.	mm in.	mm in.	mm in.	mm in.	mm in.	mm in.	mm in.	mm in.	mm in.				kg lbs.
39.688 1.5625	30.162 1.1875	-6.4 -0.25	6.4 0.25	100.0 3.94	112.0 4.41	3.3 0.13	147.0 5.79	137.0 5.39	3.2 0.12	3.6 0.14	161.5	33.7	0.0966	2.78 6.14
48.260 1.9000	38.100 1.5000	-11.9 -0.47	3.5 0.14	101.0 3.98	108.0 4.25	0.8 0.03	150.0 5.91	146.0 5.75	3.2 0.12	1.0 0.04	177.2	29.4	0.0945	3.96 8.71
55.100 2.1693	44.450 1.7500	-13.2 -0.52	3.5 0.14	102.0 4.02	117.0 4.61	3.0 0.12	153.4 6.04	141.0 5.55	4.1 0.16	0.9 0.04	198.6	33.5	0.1037	4.55 10.03
48.260 1.9000	38.100 1.5000	-11.9 -0.47	3.5 0.14	101.0 3.98	108.0 4.25	3.3 0.13	150.0 5.91	144.0 5.67	3.2 0.12	1.0 0.04	177.2	29.4	0.0945	4.08 8.99
48.260 1.9000	38.100 1.5000	-11.9 -0.47	7.0 0.28	99.0 3.90	113.0 4.45	3.3 0.13	150.0 5.91	144.0 5.67	3.2 0.12	1.0 0.04	177.2	29.4	0.0945	4.03 8.88
55.100 2.1693	42.862 1.6875	-13.2 -0.52	3.5 0.14	102.0 4.02	117.0 4.61	3.3 0.13	154.0 6.06	141.0 5.55	4.1 0.16	0.9 0.04	198.6	33.5	0.1037	4.70 10.36
55.100 2.1693	42.862 1.6875	-13.2 -0.52	3.5 0.14	102.0 4.02	117.0 4.61	0.8 0.03	154.0 6.06	144.0 5.67	4.1 0.16	0.9 0.04	198.6	33.5	0.1037	4.70 10.37
41.275 1.6250	30.162 1.1875	-2.8 -0.11	3.5 0.14	101.0 3.98	107.0 4.21	3.3 0.13	160.0 6.30	149.0 5.87	4.9 0.19	2.1 0.08	182.5	37.3	0.1056	4.00 8.80
48.260 1.9000	38.100 1.5000	-11.9 -0.47	3.5 0.14	101.0 3.98	108.0 4.25	3.3 0.13	150.0 5.91	147.0 5.79	3.2 0.12	1.0 0.04	177.2	29.4	0.0945	4.55 10.03
48.260 1.9000	38.100 1.5000	-11.9 -0.47	7.0 0.28	99.0 3.90	113.0 4.45	3.3 0.13	150.0 5.91	147.0 5.79	3.2 0.12	1.0 0.04	177.2	29.4	0.0945	4.50 9.92
56.363 2.2190	41.275 1.6250	-18.5 -0.73	3.5 0.14	100.0 3.94	106.0 4.17	3.3 0.13	155.0 6.10	149.0 5.87	5.2 0.20	1.6 0.07	197.9	34.8	0.0937	5.05 11.12
48.260 1.9000	38.100 1.5000	-9.7 -0.38	5.0 0.20	101.0 3.98	110.0 4.33	3.3 0.13	161.0 6.34	153.0 6.02	3.4 0.13	1.0 0.04	206.2	37.7	0.1017	4.87 10.75
48.006 1.8900	38.100 1.5000	-8.1 -0.32	4.8 0.19	103.0 4.06	112.0 4.41	3.3 0.13	168.0 6.61	161.0 6.34	3.6 0.14	1.3 0.05	227.3	41.3	0.1067	5.72 12.63
57.531 2.2650	44.450 1.7500	-15.2 -0.60	8.0 0.31	103.0 4.06	118.0 4.65	3.3 0.13	174.0 6.85	170.0 6.69	5.5 0.22	0.7 0.03	264.1	44.9	0.1072	7.65 16.87
57.531 2.2650	46.038 1.8125	-15.0 -0.59	8.0 0.31	105.0 4.13	120.0 4.72	3.3 0.13	179.0 7.05	171.0 6.73	2.5 0.10	3.2 0.13	265.6	28.4	0.1072	7.80 17.19
49.212 1.9375	34.925 1.3750	1.3 0.05	3.5 0.14	112.0 4.41	118.0 4.65	3.3 0.13	188.0 7.40	174.0 6.85	8.6 0.34	5.4 0.22	203.4	37.5	0.1197	7.49 16.51
36.322 1.4300	26.192 1.0312	-2.5 -0.10	3.5 0.14	98.0 3.86	105.0 4.13	0.8 0.03	142.0 5.59	135.0 5.31	4.1 0.16	1.7 0.07	151.4	38.3	0.1416	2.32 5.12

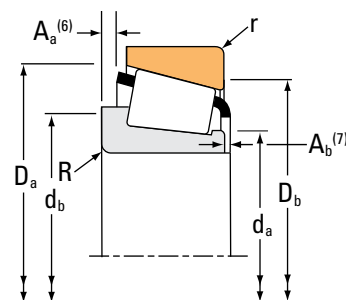
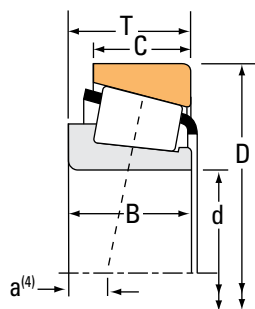
(4) Negative value indicates effective center inside cone (inner-ring) backface.  
 (5) These maximum fillet radii will be cleared by the bearing corners.  
 (6) Negative value indicates cage extends beyond cone (inner-ring) backface.  
 (7) Negative value indicates cage that does not extend beyond cone (inner-ring) front face.

Continued on next page.

# TAPERED ROLLER BEARINGS

## SINGLE-ROW • TYPE TS

### TYPE TS



Bearing Dimensions			Load Ratings							Part Number		
Bore d	O.D. D	Width T	Dynamic <sup>(1)</sup> C <sub>1</sub>		Factors <sup>(2)</sup> e Y		Dynamic <sup>(3)</sup> C <sub>90</sub> C <sub>a90</sub>		Factors <sup>(2)</sup> K	Static C <sub>0</sub>	Inner	Outer
mm in.	mm in.	mm in.	N lbf				N lbf	N lbf		N lbf		
89.090 3.5075	152.400 6.0000	39.688 1.5625	216000 48600	0.44	1.36		56000 12600	42400 9530	1.32	319000 71600	593-S	592A
89.891 3.5390	168.275 6.6250	53.975 2.1250	409000 92000	0.30	2.00		106000 23800	54300 12200	1.95	522000 117000	850A	832
89.975 3.5423	146.975 5.7864	40.000 1.5748	325000 73000	0.33	1.80		84200 18900	47900 10800	1.76	388000 87300	HM218248	HM218210
89.992 3.5430	160.096 6.3030	30.124 1.1860	181000 40600	0.42	1.42		46800 10500	33900 7620	1.38	230000 51700	69354	69630
90.000 3.5433	135.000 5.3150	24.000 0.9449	128000 28800	0.49	1.21		33300 7480	28100 6330	1.18	155000 34900	JP9049	JP9010
90.000 3.5433	145.000 5.7087	35.000 1.3780	222000 50000	0.44	1.35		57700 13000	43900 9860	1.31	313000 70500	JM718149	JM718110
90.000 3.5433	145.000 5.7087	35.000 1.3780	222000 50000	0.44	1.35		57700 13000	43900 9860	1.31	313000 70500	JM718149A	JM718110
90.000 3.5433	149.225 5.8750	31.750 1.2500	163000 36600	0.49	1.22		42200 9490	35600 8000	1.19	241000 54300	42354X	42587
90.000 3.5433	150.000 5.9055	35.992 1.4170	216000 48600	0.44	1.36		56000 12600	42400 9530	1.32	319000 71600	597X	593X
90.000 3.5433	152.400 6.0000	39.688 1.5625	216000 48600	0.44	1.36		56000 12600	42400 9530	1.32	319000 71600	597X	592A
90.000 3.5433	155.000 6.1024	44.000 1.7323	331000 74400	0.34	1.76		85800 19300	50100 11300	1.71	447000 101000	JHM318448	JHM318410
90.000 3.5433	160.000 6.2992	53.975 2.1250	439000 98800	0.40	1.50		114000 25600	78100 17600	1.46	523000 118000	6581X	6525X
90.000 3.5433	161.925 6.3750	53.975 2.1250	439000 98800	0.40	1.50		114000 25600	78100 17600	1.46	523000 118000	6581X	6535
90.000 3.5433	190.000 7.4803	50.800 2.0000	383000 86100	0.87	0.69		99300 22300	147000 33100	0.67	392000 88100	J90354	J90748
90.000 3.5433	190.000 7.4803	57.150 2.2500	534000 120000	0.33	1.79		138000 31100	79300 17800	1.74	692000 156000	JHH221436	JHH221413
90.488 3.5625	161.925 6.3750	47.625 1.8750	327000 73600	0.34	1.76		84800 19100	49500 11100	1.71	441000 99200	760	752
90.488 3.5625	168.275 6.6250	47.625 1.8750	327000 73600	0.34	1.76		84800 19100	49500 11100	1.71	441000 99200	760	753

<sup>(1)</sup>Based on 1 x 10<sup>6</sup> revolutions L<sub>10</sub> life, for the ISO life-calculation method.

<sup>(2)</sup>Consult your Timken engineer for instructions on use or review the Timken Engineering Manual on timken.com/catalogs.

<sup>(3)</sup>Based on 90 x 10<sup>6</sup> revolutions L<sub>10</sub> life, for The Timken Company life-calculation method. C<sub>90</sub> and C<sub>a90</sub> are radial and thrust values.

Bearing Dimensions											Geometry Factors			Bearing Weight
Width B	Width C	Eff. Ctr. a <sup>(4)</sup>	Shaft			Housing			Cage		G <sub>1</sub>	G <sub>2</sub>	C <sub>g</sub>	
			Max Shaft Fillet Radius R <sup>(5)</sup>	Backing Shoulder Dia. d <sub>a</sub>	Shoulder Dia. d <sub>b</sub>	Max Housing Fillet Radius r <sup>(5)</sup>	Backing Shoulder Dia. D <sub>a</sub>	Shoulder Dia. D <sub>b</sub>	A <sub>a</sub> <sup>(6)</sup>	A <sub>b</sub> <sup>(7)</sup>				
mm in.	mm in.	mm in.	mm in.	mm in.	mm in.	mm in.	mm in.	mm in.	mm in.	mm in.				kg lbs.
36.322 1.4300	30.162 1.1875	-2.5 -0.10	3.5 0.14	98.0 3.86	105.0 4.13	3.3 0.13	144.0 5.67	135.0 5.31	4.1 0.16	1.7 0.07	151.4	38.3	0.1416	2.73 6.03
56.363 2.2190	41.275 1.6250	-18.5 -0.73	3.5 0.14	101.0 3.98	107.0 4.21	3.3 0.13	155.0 6.10	149.0 5.87	5.2 0.20	1.6 0.07	197.9	34.8	0.0937	4.98 10.98
40.000 1.5748	32.500 1.2795	-8.6 -0.34	7.0 0.28	99.0 3.90	112.0 4.41	3.5 0.14	141.0 5.55	133.0 5.24	1.4 0.05	3.0 0.12	168.2	34.7	0.0921	2.52 5.56
30.162 1.1875	22.300 0.8780	-0.5 -0.02	2.3 0.09	99.0 3.90	103.0 4.06	3.3 0.13	149.0 5.87	143.0 5.63	3.7 0.14	2.5 0.10	116.8	39.6	0.0874	2.36 5.20
22.500 0.8858	17.500 0.6890	5.6 0.22	2.0 0.08	97.0 3.82	100.0 3.94	2.0 0.08	130.0 5.12	125.0 4.92	1.8 0.07	3.3 0.13	83.8	46.1	0.1196	1.08 2.38
34.000 1.3386	27.000 1.0630	-2.0 -0.08	3.0 0.12	99.0 3.90	106.0 4.17	2.5 0.10	138.8 5.46	131.0 5.16	2.1 0.08	3.9 0.16	138.0	34.9	0.0946	2.14 4.72
34.000 1.3386	27.000 1.0630	-2.0 -0.08	6.0 0.24	99.0 3.90	112.0 4.41	2.5 0.10	138.8 5.46	131.0 5.16	2.1 0.08	3.9 0.16	138.0	34.9	0.0946	2.13 4.69
28.971 1.1406	24.608 0.9688	3.0 0.12	3.0 0.12	99.0 3.90	104.0 4.09	3.3 0.13	142.0 5.59	134.0 5.28	2.8 0.11	3.0 0.12	129.7	37.2	0.1386	2.05 4.52
36.322 1.4300	27.000 1.0630	-2.5 -0.10	3.0 0.12	99.0 3.90	104.0 4.09	3.0 0.12	142.0 5.59	134.0 5.28	4.1 0.16	1.7 0.07	151.4	38.3	0.1416	2.41 5.31
36.322 1.4300	30.162 1.1875	-2.5 -0.10	3.0 0.12	99.0 3.90	104.0 4.09	3.3 0.13	144.0 5.67	135.0 5.31	4.1 0.16	1.7 0.07	151.4	38.3	0.1416	2.70 5.96
44.000 1.7323	35.500 1.3976	-9.9 -0.39	3.0 0.12	100.0 3.94	106.0 4.17	2.5 0.10	148.0 5.83	140.0 5.51	1.3 0.05	3.3 0.13	178.9	32.4	0.0948	3.33 7.32
55.100 2.1693	44.450 1.7500	-13.2 -0.52	3.0 0.12	102.0 4.02	109.0 4.29	3.0 0.12	153.4 6.04	141.0 5.55	4.1 0.16	0.9 0.04	198.6	33.5	0.1037	4.49 9.89
55.100 2.1693	42.862 1.6875	-13.2 -0.52	3.0 0.12	102.0 4.02	109.0 4.29	3.3 0.13	154.0 6.06	141.0 5.55	4.1 0.16	0.9 0.04	198.6	33.5	0.1037	4.64 10.22
46.038 1.8125	31.750 1.2500	12.7 0.50	3.5 0.14	111.8 4.40	120.0 4.72	3.3 0.13	179.3 7.06	162.0 6.38	11.0 0.43	3.7 0.15	149.6	23.8	0.1180	6.03 13.31
57.531 2.2650	46.038 1.8125	-15.0 -0.59	8.0 0.31	106.0 4.17	121.0 4.76	3.3 0.13	179.0 7.05	171.0 6.73	2.5 0.10	3.2 0.13	265.6	28.4	0.1072	7.65 16.87
48.260 1.9000	38.100 1.5000	-11.9 -0.47	3.5 0.14	101.0 3.98	110.0 4.33	3.3 0.13	150.0 5.91	144.0 5.67	3.2 0.12	1.0 0.04	177.2	29.4	0.0945	3.99 8.80
48.260 1.9000	38.100 1.5000	-11.9 -0.47	3.5 0.14	101.0 3.98	110.0 4.33	3.3 0.13	150.0 5.91	147.0 5.79	3.2 0.12	1.0 0.04	177.2	29.4	0.0945	4.46 9.84

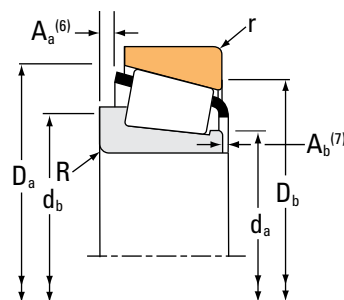
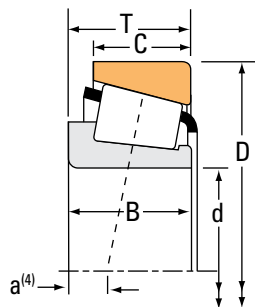
<sup>(4)</sup>Negative value indicates effective center inside cone (inner-ring) backface.  
<sup>(5)</sup>These maximum fillet radii will be cleared by the bearing corners.  
<sup>(6)</sup>Negative value indicates cage extends beyond cone (inner-ring) backface.  
<sup>(7)</sup>Negative value indicates cage that does not extend beyond cone (inner-ring) front face.

Continued on next page.

# TAPERED ROLLER BEARINGS

## SINGLE-ROW • TYPE TS

### TYPE TS



Bearing Dimensions			Load Ratings							Part Number			
Bore d	O.D. D	Width T	Dynamic <sup>(1)</sup>		Factors <sup>(2)</sup>		Dynamic <sup>(3)</sup>		Factors <sup>(2)</sup>		Static C <sub>0</sub>	Inner	Outer
			C <sub>1</sub>	e	Y	C <sub>90</sub>	C <sub>a90</sub>	K	N	N			
mm in.	mm in.	mm in.	N lbf			N lbf	N lbf		N lbf				
91.973 3.6210	142.875 5.6250	30.000 1.1811	164000 36800	0.48	1.25	42400 9540	34700 7810	1.22	240000 53900		LM718947	LM718910	
92.075 3.6250	130.175 5.1250	20.638 0.8125	95400 21400	0.35	1.72	24700 5560	14800 3320	1.67	166000 37400		L319245	L319210	
92.075 3.6250	146.050 5.7500	33.338 1.3125	197000 44300	0.45	1.34	51100 11500	39200 8810	1.30	307000 69000		47890	47820	
92.075 3.6250	147.638 5.8125	35.717 1.4062	216000 48600	0.44	1.36	56000 12600	42400 9530	1.32	319000 71600		598	592XS	
92.075 3.6250	147.638 5.8125	35.717 1.4062	216000 48600	0.44	1.36	56000 12600	42400 9530	1.32	319000 71600		598	592XE	
92.075 3.6250	148.430 5.8437	28.575 1.1250	163000 36600	0.49	1.22	42200 9490	35600 8000	1.19	241000 54300		42362	42584	
92.075 3.6250	149.225 5.8750	31.750 1.2500	163000 36600	0.49	1.22	42200 9490	35600 8000	1.19	241000 54300		42362	42587	
92.075 3.6250	150.000 5.9055	35.966 1.4160	216000 48600	0.44	1.36	56000 12600	42400 9530	1.32	319000 71600		598	JM719113	
92.075 3.6250	152.400 6.0000	39.688 1.5625	216000 48600	0.44	1.36	56000 12600	42400 9530	1.32	319000 71600		598	592A	
92.075 3.6250	152.400 6.0000	39.688 1.5625	216000 48600	0.44	1.36	56000 12600	42400 9530	1.32	319000 71600		598A	592A	
92.075 3.6250	152.400 6.0000	39.688 1.5625	216000 48600	0.44	1.36	56000 12600	42400 9530	1.32	319000 71600		598	592-S	
92.075 3.6250	152.400 6.0000	39.688 1.5625	216000 48600	0.44	1.36	56000 12600	42400 9530	1.32	319000 71600		598X	592A	
92.075 3.6250	168.275 6.6250	41.275 1.6250	265000 59500	0.47	1.28	68600 15400	55300 12400	1.24	386000 86700		681	672	
92.075 3.6250	168.275 6.6250	41.275 1.6250	265000 59500	0.47	1.28	68600 15400	55300 12400	1.24	386000 86700		681A	672	
92.075 3.6250	171.450 6.7500	47.625 1.8750	340000 76400	0.37	1.63	88100 19800	55300 12400	1.59	474000 107000		77362	77675	
92.075 3.6250	171.450 6.7500	47.625 1.8750	340000 76400	0.37	1.63	88100 19800	55300 12400	1.59	474000 107000		77364	77675	
92.075 3.6250	180.975 7.1250	47.625 1.8750	346000 77800	0.39	1.56	89700 20200	59200 13300	1.51	495000 111000		778	772	

<sup>(1)</sup>Based on  $1 \times 10^6$  revolutions  $L_{10}$  life, for the ISO life-calculation method.

<sup>(2)</sup>Consult your Timken engineer for instructions on use or review the Timken Engineering Manual on [timken.com/catalogs](http://timken.com/catalogs).

<sup>(3)</sup>Based on  $90 \times 10^6$  revolutions  $L_{10}$  life, for The Timken Company life-calculation method.  $C_{90}$  and  $C_{a90}$  are radial and thrust values.

Bearing Dimensions											Geometry Factors			Bearing Weight
Width B	Width C	Eff. Ctr. a <sup>(4)</sup>	Shaft			Housing			Cage		G <sub>1</sub>	G <sub>2</sub>	C <sub>g</sub>	
			Max Shaft Fillet Radius R <sup>(5)</sup>	Backing Shoulder Dia. d <sub>a</sub> d <sub>b</sub>		Max Housing Fillet Radius r <sup>(5)</sup>	Backing Shoulder Dia. D <sub>a</sub> D <sub>b</sub>		A <sub>a</sub> <sup>(6)</sup>	A <sub>b</sub> <sup>(7)</sup>				
mm in.	mm in.	mm in.	mm in.	mm in.	mm in.	mm in.	mm in.	mm in.	mm in.	mm in.				kg lbs.
30.000 1.1811	22.000 0.8661	1.8 0.07	3.5 0.14	100.0 3.94	106.0 4.17	3.3 0.13	138.0 5.43	129.0 5.08	2.7 0.10	2.0 0.08	124.2	37.6	0.1355	1.63 3.60
21.433 0.8438	16.670 0.6563	1.3 0.05	3.5 0.14	99.0 3.90	105.0 4.13	1.5 0.06	125.0 4.92	122.0 4.80	0.6 0.02	1.4 0.06	125.3	90.8	0.1220	0.86 1.88
34.925 1.3750	26.195 1.0313	-1.0 -0.04	3.5 0.14	101.0 3.98	107.0 4.21	3.3 0.13	140.0 5.51	131.0 5.16	2.5 0.10	0.3 0.02	153.2	38.1	0.1428	2.06 4.54
36.322 1.4300	26.192 1.0312	-2.5 -0.10	3.5 0.14	101.0 3.98	107.0 4.21	3.3 0.13	142.0 5.59	133.0 5.24	4.1 0.16	1.7 0.07	151.4	38.3	0.1416	2.18 4.82
36.322 1.4300	26.192 1.0312	-2.5 -0.10	3.5 0.14	101.0 3.98	107.0 4.21	0.8 0.03	142.0 5.59	135.0 5.31	4.1 0.16	1.7 0.07	151.4	38.3	0.1416	2.20 4.86
28.971 1.1406	21.433 0.8438	3.0 0.12	3.5 0.14	101.0 3.98	107.0 4.21	3.0 0.12	142.0 5.59	134.0 5.28	2.8 0.11	3.0 0.12	129.7	37.2	0.1386	1.83 4.02
28.971 1.1406	24.608 0.9688	3.0 0.12	3.5 0.14	101.0 3.98	107.0 4.21	3.3 0.13	142.0 5.59	134.0 5.28	2.8 0.11	3.0 0.12	129.7	37.2	0.1386	1.98 4.36
36.322 1.4300	27.000 1.0630	-2.5 -0.10	3.5 0.14	101.0 3.98	107.0 4.21	2.5 0.10	143.0 5.63	135.0 5.31	4.1 0.16	1.7 0.07	151.4	38.3	0.1416	2.32 5.12
36.322 1.4300	30.162 1.1875	-2.5 -0.10	3.5 0.14	101.0 3.98	107.0 4.21	3.3 0.13	144.0 5.67	135.0 5.31	4.1 0.16	1.7 0.07	151.4	38.3	0.1416	2.61 5.76
36.322 1.4300	30.162 1.1875	-2.5 -0.10	6.4 0.25	101.0 3.98	113.0 4.45	3.3 0.13	144.0 5.67	135.0 5.31	4.1 0.16	1.7 0.07	151.4	38.3	0.1416	2.58 5.69
36.322 1.4300	39.688 1.5625	-2.5 -0.10	3.5 0.14	101.0 3.98	107.0 4.21	3.3 0.13	147.0 5.79	135.0 5.31	4.1 0.16	1.7 0.07	151.4	38.3	0.1416	2.75 6.06
36.322 1.4300	30.162 1.1875	-2.5 -0.10	3.5 0.14	104.0 4.09	107.0 4.21	3.3 0.13	144.0 5.67	135.0 5.31	4.1 0.16	1.7 0.07	151.4	38.3	0.1416	2.61 5.75
41.275 1.6250	30.162 1.1875	-2.8 -0.11	3.5 0.14	104.0 4.09	110.0 4.33	3.3 0.13	160.0 6.30	149.0 5.87	4.9 0.19	2.1 0.08	182.5	37.3	0.1056	3.85 8.48
41.275 1.6250	30.162 1.1875	-2.8 -0.11	6.4 0.25	104.0 4.09	116.0 4.57	3.3 0.13	160.0 6.30	149.0 5.87	4.9 0.19	2.1 0.08	182.5	37.3	0.1056	3.82 8.41
48.260 1.9000	38.100 1.5000	-9.7 -0.38	3.5 0.14	103.0 4.06	109.0 4.29	3.3 0.13	161.0 6.34	153.0 6.02	3.4 0.13	1.0 0.04	206.2	37.7	0.1017	4.72 10.41
48.260 1.9000	38.100 1.5000	-9.7 -0.38	6.4 0.25	103.0 4.06	115.0 4.53	3.3 0.13	161.0 6.34	153.0 6.02	3.4 0.13	1.0 0.04	206.2	37.7	0.1017	4.68 10.33
48.006 1.8900	38.100 1.5000	-8.1 -0.32	3.5 0.14	105.0 4.13	111.0 4.37	3.3 0.13	168.0 6.61	161.0 6.34	3.6 0.14	1.3 0.05	227.3	41.3	0.1067	5.57 12.28

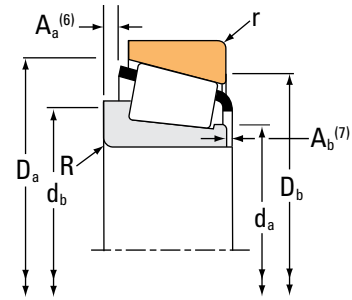
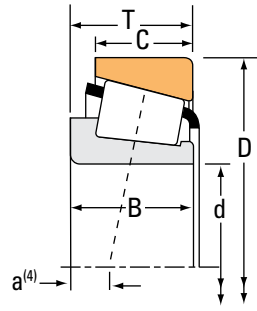
<sup>(4)</sup>Negative value indicates effective center inside cone (inner-ring) backface.  
<sup>(5)</sup>These maximum fillet radii will be cleared by the bearing corners.  
<sup>(6)</sup>Negative value indicates cage extends beyond cone (inner-ring) backface.  
<sup>(7)</sup>Negative value indicates cage that does not extend beyond cone (inner-ring) front face.

Continued on next page.

# TAPERED ROLLER BEARINGS

## SINGLE-ROW • TYPE TS

### TYPE TS



Bearing Dimensions			Load Ratings							Part Number			
Bore d	O.D. D	Width T	Dynamic <sup>(1)</sup>		Factors <sup>(2)</sup>		Dynamic <sup>(3)</sup>		Factors <sup>(2)</sup>		Static C <sub>0</sub>	Inner	Outer
			C <sub>1</sub>	e	Y	C <sub>90</sub>	C <sub>a90</sub>	K	N	N			
mm in.	mm in.	mm in.	N lbf			N lbf	N lbf		N lbf				
92.075 3.6250	190.500 7.5000	57.150 2.2500	458000 103000	0.33	1.79	119000 26700	68000 15300	1.74	630000 142000		857	854	
92.075 3.6250	190.500 7.5000	57.150 2.2500	534000 120000	0.33	1.79	138000 31100	79300 17800	1.74	692000 156000		HH221438	HH221410	
92.075 3.6250	214.312 8.4375	73.025 2.8750	644000 145000	0.46	1.31	167000 37500	131000 29500	1.27	786000 177000		EE213362	213843	
93.662 3.6875	148.430 5.8437	28.575 1.1250	193000 43400	0.49	1.22	50100 11300	42200 9480	1.19	241000 54300		42368	42584	
93.662 3.6875	149.225 5.8750	31.750 1.2500	193000 43400	0.49	1.22	50100 11300	42200 9480	1.19	241000 54300		42368	42587	
93.662 3.6875	152.400 6.0000	39.688 1.5625	216000 48600	0.44	1.36	56000 12600	42400 9530	1.32	319000 71600		597	592A	
94.975 3.7392	149.975 5.9045	31.750 1.2500	163000 36600	0.49	1.22	42200 9490	35600 8000	1.19	241000 54300		42373	42590	
94.975 3.7392	168.275 6.6250	41.275 1.6250	265000 59500	0.47	1.28	68600 15400	55300 12400	1.24	386000 86700		682	672	
95.000 3.7402	135.000 5.3150	20.000 0.7874	83000 18700	0.58	1.03	21500 4840	21500 4830	1.00	133000 29900		JL819349	JL819310	
95.000 3.7402	145.000 5.7087	24.000 0.9449	125000 28200	0.47	1.27	32500 7310	26300 5920	1.24	172000 38700		JP10044	JP10010	
95.000 3.7402	150.000 5.9055	35.000 1.3780	215000 48300	0.44	1.36	55700 12500	42100 9470	1.32	316000 71100		JM719149	JM719113	
95.000 3.7402	152.400 6.0000	39.688 1.5625	216000 48600	0.44	1.36	56000 12600	42400 9530	1.32	319000 71600		J594X	592A	
95.000 3.7402	160.000 6.2992	46.000 1.8110	354000 79700	0.34	1.77	91900 20700	53200 12000	1.73	506000 114000		JF9549	JF9510	
95.000 3.7402	190.000 7.4803	57.000 2.2441	458000 103000	0.33	1.79	119000 26700	68000 15300	1.74	630000 142000		862	853	
95.250 3.7500	130.175 5.1250	20.638 0.8125	95400 21400	0.35	1.72	24700 5560	14800 3320	1.67	166000 37400		L319249	L319210	
95.250 3.7500	136.525 5.3750	30.162 1.1875	140000 31400	0.28	2.11	36200 8140	17600 3950	2.06	227000 51100		LM119348	LM119311	
95.250 3.7500	146.050 5.7500	33.338 1.3125	197000 44300	0.45	1.34	51100 11500	39200 8810	1.30	307000 69000		47896	47820	

<sup>(1)</sup>Based on 1 x 10<sup>6</sup> revolutions L<sub>10</sub> life, for the ISO life-calculation method.

<sup>(2)</sup>Consult your Timken engineer for instructions on use or review the Timken Engineering Manual on timken.com/catalogs.

<sup>(3)</sup>Based on 90 x 10<sup>6</sup> revolutions L<sub>10</sub> life, for The Timken Company life-calculation method. C<sub>90</sub> and C<sub>a90</sub> are radial and thrust values.

Bearing Dimensions											Geometry Factors			Bearing Weight
Width B	Width C	Eff. Ctr. a <sup>(4)</sup>	Shaft			Housing			Cage		G <sub>1</sub>	G <sub>2</sub>	C <sub>g</sub>	
			Max Shaft Fillet Radius R <sup>(5)</sup>	Backing Shoulder Dia. d <sub>a</sub>	Backing Shoulder Dia. d <sub>b</sub>	Max Housing Fillet Radius r <sup>(5)</sup>	Backing Shoulder Dia. D <sub>a</sub>	Backing Shoulder Dia. D <sub>b</sub>	A <sub>a</sub> <sup>(6)</sup>	A <sub>b</sub> <sup>(7)</sup>				
mm in.	mm in.	mm in.	mm in.	mm in.	mm in.	mm in.	mm in.	mm in.	mm in.	mm in.				kg lbs.
57.531 2.2650	44.450 1.7500	-15.2 -0.60	8.0 0.31	106.0 4.17	121.0 4.76	3.3 0.13	174.0 6.85	170.0 6.69	5.5 0.22	0.7 0.03	264.1	44.9	0.1072	7.44 16.42
57.531 2.2650	46.038 1.8125	-15.0 -0.59	8.0 0.31	107.0 4.21	122.0 4.80	3.3 0.13	179.0 7.05	171.0 6.73	2.5 0.10	3.2 0.13	265.6	28.4	0.1072	7.59 16.73
73.025 2.8750	53.975 2.1250	-18.3 -0.72	9.7 0.38	117.0 4.61	135.0 5.31	6.4 0.25	195.8 7.71	182.0 7.17	9.9 0.39	3.6 0.14	262.4	38.1	0.1180	12.38 27.28
28.971 1.1406	21.433 0.8438	3.0 0.12	3.0 0.12	102.0 4.02	107.0 4.21	3.0 0.12	142.0 5.59	134.0 5.28	2.8 0.11	3.0 0.12	129.7	37.2	0.1386	1.78 3.91
28.971 1.1406	24.608 0.9688	3.0 0.12	3.0 0.12	102.0 4.02	107.0 4.21	3.3 0.13	142.0 5.59	134.0 5.28	2.8 0.11	3.0 0.12	129.7	37.2	0.1386	1.93 4.25
36.322 1.4300	30.162 1.1875	-2.5 -0.10	3.5 0.14	102.0 4.02	109.0 4.29	3.3 0.13	144.0 5.67	135.0 5.31	4.1 0.16	1.7 0.07	151.4	38.3	0.1416	2.54 5.61
28.971 1.1406	24.608 0.9688	3.0 0.12	3.0 0.12	103.0 4.06	108.0 4.25	3.3 0.13	143.0 5.63	135.0 5.31	2.8 0.11	3.0 0.12	129.7	37.2	0.1386	1.93 4.25
41.275 1.6250	30.162 1.1875	-2.8 -0.11	3.5 0.14	106.0 4.17	113.0 4.45	3.3 0.13	160.0 6.30	149.0 5.87	4.9 0.19	2.1 0.08	182.5	37.3	0.1056	3.71 8.18
20.000 0.7874	14.000 0.5512	10.9 0.43	5.0 0.20	102.0 4.02	111.0 4.37	2.5 0.10	129.0 5.08	123.0 4.84	2.4 0.09	1.4 0.06	93.3	70.6	0.1298	0.85 1.88
22.500 0.8858	17.500 0.6890	6.1 0.24	3.0 0.12	102.0 4.02	108.0 4.25	3.0 0.12	140.0 5.51	134.0 5.28	1.9 0.07	3.3 0.13	104.0	40.9	0.1264	1.26 2.79
34.000 1.3386	27.000 1.0630	-1.6 -0.06	3.0 0.12	104.0 4.09	109.0 4.29	2.5 0.10	143.0 5.63	135.0 5.31	3.1 0.12	3.1 0.12	150.5	36.1	0.1413	2.15 4.75
36.322 1.4300	30.162 1.1875	2.5 0.10	8.0 0.31	103.0 4.06	119.0 4.69	3.3 0.13	144.0 5.67	135.0 5.31	4.1 0.16	1.7 0.07	151.4	38.3	0.1416	2.43 5.35
46.000 1.8110	38.000 1.4961	-10.7 -0.42	3.0 0.12	105.4 4.15	111.0 4.37	3.0 0.12	154.0 6.06	145.0 5.71	1.4 0.05	3.1 0.12	209.8	39.7	0.0998	3.74 8.22
57.531 2.2650	48.000 1.8898	-15.2 -0.60	6.4 0.25	108.0 4.25	120.0 4.72	3.0 0.12	174.3 6.86	170.0 6.69	5.5 0.22	0.7 0.03	264.1	44.9	0.1072	7.35 16.22
21.433 0.8438	16.670 0.6563	1.3 0.05	1.5 0.06	101.0 3.98	103.0 4.06	1.5 0.06	125.0 4.92	122.0 4.80	0.6 0.02	1.4 0.06	125.3	90.8	0.1220	0.79 1.74
30.162 1.1875	24.608 0.9688	-4.6 -0.18	2.3 0.09	102.0 4.02	105.0 4.13	2.3 0.09	131.0 5.16	126.0 4.96	1.3 0.05	-0.2 0.00	149.4	84.1	0.1213	1.33 2.94
34.925 1.3750	26.195 1.0313	-1.0 -0.04	3.5 0.14	103.0 4.06	110.0 4.33	3.3 0.13	140.0 5.51	131.0 5.16	2.5 0.10	0.3 0.02	153.2	38.1	0.1428	1.94 4.26

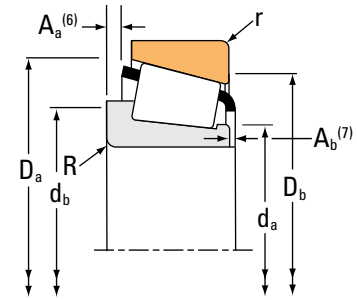
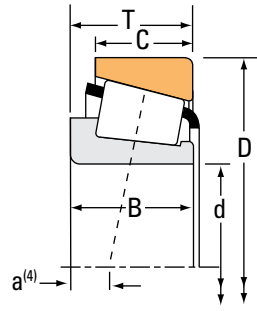
(4) Negative value indicates effective center inside cone (inner-ring) backface.  
 (5) These maximum fillet radii will be cleared by the bearing corners.  
 (6) Negative value indicates cage extends beyond cone (inner-ring) backface.  
 (7) Negative value indicates cage that does not extend beyond cone (inner-ring) front face.

Continued on next page.

# TAPERED ROLLER BEARINGS

## SINGLE-ROW • TYPE TS

### TYPE TS



Bearing Dimensions			Load Ratings							Part Number			
Bore d	O.D. D	Width T	Dynamic <sup>(1)</sup>		Factors <sup>(2)</sup>		Dynamic <sup>(3)</sup>		Factors <sup>(2)</sup>		Static C <sub>0</sub>	Inner	Outer
			C <sub>1</sub>	e	Y	C <sub>90</sub>	C <sub>a90</sub>	K	N	N			
mm in.	mm in.	mm in.	N lbf			N lbf	N lbf		N lbf				
95.250 3.7500	146.050 5.7500	33.338 1.3125	197000 44300	0.45	1.34	51100 11500	39200 8810	1.30	307000 69000		47898	47820	
95.250 3.7500	147.638 5.8125	35.717 1.4062	216000 48600	0.44	1.36	56000 12600	42400 9530	1.32	319000 71600		594	592XS	
95.250 3.7500	147.828 5.8200	35.717 1.4062	216000 48600	0.44	1.36	56000 12600	42400 9530	1.32	319000 71600		594	592AX	
95.250 3.7500	148.430 5.8437	28.575 1.1250	193000 43400	0.49	1.22	50100 11300	42200 9480	1.19	241000 54300		42375	42584	
95.250 3.7500	148.430 5.8437	28.575 1.1250	193000 43400	0.49	1.22	50100 11300	42200 9480	1.19	241000 54300		42376	42584	
95.250 3.7500	148.430 5.8437	28.575 1.1250	163000 36600	0.49	1.22	42200 9490	35600 8000	1.19	241000 54300		42375A	42584	
95.250 3.7500	149.225 5.8750	31.750 1.2500	193000 43400	0.49	1.22	50100 11300	42200 9480	1.19	241000 54300		42376	42587	
95.250 3.7500	149.225 5.8750	31.750 1.2500	193000 43400	0.49	1.22	50100 11300	42200 9480	1.19	241000 54300		42375	42587	
95.250 3.7500	150.000 5.9055	35.966 1.4160	216000 48600	0.44	1.36	56000 12600	42400 9530	1.32	319000 71600		594	JM719113	
95.250 3.7500	150.000 5.9055	35.966 1.4160	216000 48600	0.44	1.36	56000 12600	42400 9530	1.32	319000 71600		594AA	JM719113	
95.250 3.7500	150.000 5.9055	35.992 1.4170	216000 48600	0.44	1.36	56000 12600	42400 9530	1.32	319000 71600		594	593X	
95.250 3.7500	152.400 6.0000	39.688 1.5625	216000 48600	0.44	1.36	56000 12600	42400 9530	1.32	319000 71600		594	592A	
95.250 3.7500	152.400 6.0000	39.688 1.5625	216000 48600	0.44	1.36	56000 12600	42400 9530	1.32	319000 71600		594A	592A	
95.250 3.7500	157.162 6.1875	36.512 1.4375	223000 50200	0.47	1.26	57900 13000	47100 10600	1.23	343000 77000		52375	52618	
95.250 3.7500	161.925 6.3750	36.512 1.4375	223000 50200	0.47	1.26	57900 13000	47100 10600	1.23	343000 77000		52375	52637	
95.250 3.7500	161.925 6.3750	39.687 1.5626	223000 50200	0.47	1.26	57900 13000	47100 10600	1.23	343000 77000		52375	52638	
95.250 3.7500	168.275 6.6250	41.275 1.6250	265000 59500	0.47	1.28	68600 15400	55300 12400	1.24	386000 86700		683	672	

<sup>(1)</sup>Based on 1 x 10<sup>6</sup> revolutions L<sub>10</sub> life, for the ISO life-calculation method.

<sup>(2)</sup>Consult your Timken engineer for instructions on use or review the Timken Engineering Manual on timken.com/catalogs.

<sup>(3)</sup>Based on 90 x 10<sup>6</sup> revolutions L<sub>10</sub> life, for The Timken Company life-calculation method. C<sub>90</sub> and C<sub>a90</sub> are radial and thrust values.



Bearing Dimensions											Geometry Factors			Bearing Weight
Width B	Width C	Eff. Ctr. a <sup>(4)</sup>	Shaft			Housing			Cage		G <sub>1</sub>	G <sub>2</sub>	C <sub>g</sub>	
			Max Shaft Fillet Radius R <sup>(5)</sup>	Backing Shoulder Dia. d <sub>a</sub>	Backing Shoulder Dia. d <sub>b</sub>	Max Housing Fillet Radius r <sup>(5)</sup>	Backing Shoulder Dia. D <sub>a</sub>	Backing Shoulder Dia. D <sub>b</sub>	A <sub>a</sub> <sup>(6)</sup>	A <sub>b</sub> <sup>(7)</sup>				
mm in.	mm in.	mm in.	mm in.	mm in.	mm in.	mm in.	mm in.	mm in.	mm in.	mm in.				kg lbs.
34.925 1.3750	26.195 1.0313	-1.0 -0.04	7.0 0.28	103.0 4.06	117.0 4.61	3.3 0.13	140.0 5.51	131.0 5.16	2.5 0.10	0.3 0.02	153.2	38.1	0.1428	1.88 4.13
36.322 1.4300	26.192 1.0312	-2.5 -0.10	3.5 0.14	104.0 4.09	110.0 4.33	3.3 0.13	142.0 5.59	133.0 5.24	4.1 0.16	1.7 0.07	151.4	38.3	0.1416	2.05 4.52
36.322 1.4300	26.192 1.0312	-2.5 -0.10	3.5 0.14	104.0 4.09	110.0 4.33	3.3 0.13	142.0 5.59	133.0 5.24	4.1 0.16	1.7 0.07	151.4	38.3	0.1416	2.09 4.60
28.971 1.1406	21.433 0.8438	3.0 0.12	3.0 0.12	103.0 4.06	108.0 4.25	3.0 0.12	142.0 5.59	134.0 5.28	2.8 0.11	3.0 0.12	129.7	37.2	0.1386	1.73 3.81
28.971 1.1406	21.433 0.8438	3.0 0.12	3.5 0.14	103.0 4.06	109.0 4.29	3.0 0.12	142.0 5.59	134.0 5.28	2.8 0.11	3.0 0.12	129.7	37.2	0.1386	1.73 3.80
28.971 1.1406	21.433 0.8438	3.0 0.12	0.8 0.03	103.0 4.06	109.0 4.09	3.0 0.12	142.0 5.59	134.0 5.28	2.8 0.11	3.0 0.12	129.7	37.2	0.1386	1.73 3.82
28.971 1.1406	24.608 0.9688	3.0 0.12	3.5 0.14	103.0 4.06	109.0 4.29	3.3 0.13	142.0 5.59	134.0 5.28	2.8 0.11	3.0 0.12	129.7	37.2	0.1386	1.88 4.14
28.971 1.1406	24.608 0.9688	3.0 0.12	3.0 0.12	103.0 4.06	108.0 4.25	3.3 0.13	142.0 5.59	134.0 5.28	2.8 0.11	3.0 0.12	129.7	37.2	0.1386	1.88 4.15
36.322 1.4300	27.000 1.0630	-2.5 -0.10	3.5 0.14	104.0 4.09	110.0 4.33	2.5 0.10	143.0 5.63	135.0 5.31	4.1 0.16	1.7 0.07	151.4	38.3	0.1416	2.19 4.83
36.322 1.4300	27.000 1.0630	-2.5 -0.10	0.8 0.03	104.0 4.09	107.0 4.21	2.5 0.10	143.0 5.63	135.0 5.31	4.1 0.16	1.7 0.07	151.4	38.3	0.1416	2.20 4.87
36.322 1.4300	27.000 1.0630	-2.5 -0.10	3.5 0.14	104.0 4.09	110.0 4.33	3.0 0.12	142.0 5.59	134.0 5.28	4.1 0.16	1.7 0.07	151.4	38.3	0.1416	2.19 4.82
36.322 1.4300	30.162 1.1875	-2.5 -0.10	3.5 0.14	104.0 4.09	110.0 4.33	3.3 0.13	144.0 5.67	135.0 5.31	4.1 0.16	1.7 0.07	151.4	38.3	0.1416	2.48 5.47
36.322 1.4300	30.162 1.1875	-2.5 -0.10	5.0 0.20	104.0 4.09	113.0 4.45	3.3 0.13	144.0 5.67	135.0 5.31	4.1 0.16	1.7 0.07	151.4	38.3	0.1416	2.46 5.43
36.116 1.4219	26.195 1.0313	-0.5 -0.02	3.5 0.14	105.0 4.13	112.0 4.41	3.3 0.13	152.0 5.98	142.0 5.59	4.4 0.17	2.5 0.10	175.4	41.7	0.1519	2.67 5.88
36.116 1.4219	26.195 1.0313	-0.5 -0.02	3.5 0.14	105.0 4.13	112.0 4.41	3.3 0.13	154.0 6.06	144.0 5.67	4.4 0.17	2.5 0.10	175.4	41.7	0.1519	2.90 6.39
36.116 1.4219	29.370 1.1563	-0.5 -0.02	3.5 0.14	105.0 4.13	112.0 4.41	3.3 0.13	154.0 6.06	143.0 5.63	4.4 0.17	2.5 0.10	175.4	41.7	0.1519	3.07 6.76
41.275 1.6250	30.162 1.1875	-2.8 -0.11	3.5 0.14	106.0 4.17	113.0 4.45	3.3 0.13	160.0 6.30	149.0 5.87	4.9 0.19	2.1 0.08	182.5	37.3	0.1056	3.70 8.15

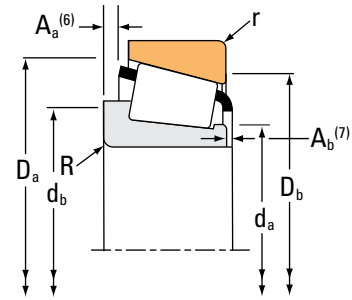
(4) Negative value indicates effective center inside cone (inner-ring) backface.  
 (5) These maximum fillet radii will be cleared by the bearing corners.  
 (6) Negative value indicates cage extends beyond cone (inner-ring) backface.  
 (7) Negative value indicates cage that does not extend beyond cone (inner-ring) front face.

Continued on next page.

# TAPERED ROLLER BEARINGS

## SINGLE-ROW • TYPE TS

### TYPE TS



Bearing Dimensions			Load Ratings							Part Number			
Bore d	O.D. D	Width T	Dynamic <sup>(1)</sup>		Factors <sup>(2)</sup>		Dynamic <sup>(3)</sup>		Factors <sup>(2)</sup>		Static C <sub>0</sub>	Inner	Outer
			C <sub>1</sub>	e	Y	C <sub>90</sub>	C <sub>a90</sub>	K	N	N			
mm in.	mm in.	mm in.	N lbf			N lbf	N lbf		N lbf				
95.250 3.7500	168.275 6.6250	41.275 1.6250	265000 59500	0.47	1.28	68600 15400	55300 12400	1.24	386000 86700		683XA	672	
95.250 3.7500	171.450 6.7500	47.625 1.8750	403000 90500	0.37	1.63	104000 23500	65600 14700	1.59	474000 107000		77375	77675	
95.250 3.7500	171.450 6.7500	47.625 1.8750	340000 76400	0.37	1.63	88100 19800	55300 12400	1.59	474000 107000		77376	77675	
95.250 3.7500	171.450 6.7500	50.800 2.0000	403000 90500	0.37	1.63	104000 23500	65600 14700	1.59	474000 107000		77375	77676X	
95.250 3.7500	180.975 7.1250	47.625 1.8750	346000 77800	0.39	1.56	89700 20200	59200 13300	1.51	495000 111000		776	772	
95.250 3.7500	190.500 7.5000	57.150 2.2500	458000 103000	0.33	1.79	119000 26700	68000 15300	1.74	630000 142000		864	854	
95.250 3.7500	190.500 7.5000	57.150 2.2500	534000 120000	0.33	1.79	138000 31100	79300 17800	1.74	692000 156000		HH221440	HH221410	
95.250 3.7500	200.025 7.8750	61.912 2.4375	534000 120000	0.33	1.79	138000 31100	79300 17800	1.74	692000 156000		HH221440	HH221416	
95.250 3.7500	200.025 7.8750	73.025 2.8750	715000 161000	0.32	1.88	185000 41700	101000 22800	1.83	906000 204000		EH220749	EH220710	
96.838 3.8125	148.430 5.8437	28.575 1.1250	193000 43400	0.49	1.22	50100 11300	42200 9480	1.19	241000 54300		42381	42584	
96.838 3.8125	149.225 5.8750	31.750 1.2500	193000 43400	0.49	1.22	50100 11300	42200 9480	1.19	241000 54300		42381	42587	
96.838 3.8125	188.912 7.4375	50.800 2.0000	383000 86100	0.87	0.69	99300 22300	147000 33100	0.67	392000 88100		90381	90744	
98.425 3.8750	157.162 6.1875	36.512 1.4375	223000 50200	0.47	1.26	57900 13000	47100 10600	1.23	343000 77000		52387	52618	
98.425 3.8750	161.925 6.3750	36.512 1.4375	223000 50200	0.47	1.26	57900 13000	47100 10600	1.23	343000 77000		52387	52637	
98.425 3.8750	168.275 6.6250	41.275 1.6250	265000 59500	0.47	1.28	68600 15400	55300 12400	1.24	386000 86700		685	672	
98.425 3.8750	180.975 7.1250	47.625 1.8750	346000 77800	0.39	1.56	89700 20200	59200 13300	1.51	495000 111000		779	772	
98.425 3.8750	184.150 7.2500	63.500 2.5000	628000 141000	0.37	1.60	163000 36600	104000 23500	1.56	772000 174000		HH421246C	HH421210	

<sup>(1)</sup>Based on 1 x 10<sup>6</sup> revolutions L<sub>10</sub> life, for the ISO life-calculation method.

<sup>(2)</sup>Consult your Timken engineer for instructions on use or review the Timken Engineering Manual on timken.com/catalogs.

<sup>(3)</sup>Based on 90 x 10<sup>6</sup> revolutions L<sub>10</sub> life, for The Timken Company life-calculation method. C<sub>90</sub> and C<sub>a90</sub> are radial and thrust values.

Bearing Dimensions											Geometry Factors			Bearing Weight
Width B	Width C	Eff. Ctr. a <sup>(4)</sup>	Shaft			Housing			Cage		G <sub>1</sub>	G <sub>2</sub>	C <sub>g</sub>	
			Max Shaft Fillet Radius R <sup>(5)</sup>	Backing Shoulder Dia. d <sub>a</sub>	Backing Shoulder Dia. d <sub>b</sub>	Max Housing Fillet Radius r <sup>(5)</sup>	Backing Shoulder Dia. D <sub>a</sub>	Backing Shoulder Dia. D <sub>b</sub>	A <sub>a</sub> <sup>(6)</sup>	A <sub>b</sub> <sup>(7)</sup>				
mm in.	mm in.	mm in.	mm in.	mm in.	mm in.	mm in.	mm in.	mm in.	mm in.	mm in.				kg lbs.
41.275 1.6250	30.162 1.1875	-2.8 -0.11	5.0 0.20	106.0 4.17	116.0 4.57	3.3 0.13	160.0 6.30	149.0 5.87	4.9 0.19	2.1 0.08	182.5	37.3	0.1056	3.69 8.11
48.260 1.9000	38.100 1.5000	-9.7 -0.38	3.5 0.14	106.0 4.17	113.0 4.45	3.3 0.13	161.0 6.34	153.0 6.02	3.4 0.13	1.0 0.04	206.2	37.7	0.1017	4.54 10.02
48.260 1.9000	38.100 1.5000	-9.7 -0.38	6.4 0.25	106.0 4.17	118.0 4.65	3.3 0.13	161.0 6.34	153.0 6.02	3.4 0.13	1.0 0.04	206.2	37.7	0.1017	4.51 9.94
48.260 1.9000	41.275 1.6250	-9.7 -0.38	3.5 0.14	106.0 4.17	113.0 4.45	3.3 0.13	161.0 6.34	152.0 5.98	3.4 0.13	1.0 0.04	206.2	37.7	0.1017	4.74 10.45
48.006 1.8900	38.100 1.5000	-8.1 -0.32	3.5 0.14	107.0 4.21	114.0 4.49	3.3 0.13	168.0 6.61	161.0 6.34	3.6 0.14	1.3 0.05	227.3	41.3	0.1067	5.39 11.89
57.531 2.2650	44.450 1.7500	-15.2 -0.60	8.0 0.31	108.0 4.25	123.0 4.84	3.3 0.13	174.0 6.85	170.0 6.69	5.5 0.22	0.7 0.03	264.1	44.9	0.1072	7.23 15.95
57.531 2.2650	46.038 1.8125	-15.0 -0.59	8.0 0.31	110.0 4.33	125.0 4.92	3.3 0.13	179.0 7.05	171.0 6.73	2.5 0.10	3.2 0.13	265.6	28.4	0.1072	7.38 16.26
57.531 2.2650	50.800 2.0000	-15.0 -0.59	8.0 0.31	110.0 4.33	125.0 4.92	3.3 0.13	179.0 7.05	174.0 6.85	2.5 0.10	3.2 0.13	265.6	28.4	0.1072	8.87 19.53
73.025 2.8750	58.738 2.3125	-24.6 -0.97	3.3 0.13	115.7 4.55	120.0 4.72	3.3 0.13	186.9 7.36	177.0 6.97	5.7 0.22	2.4 0.10	306.3	26.2	0.1106	10.65 23.48
28.971 1.1406	21.433 0.8438	3.0 0.12	3.5 0.14	105.0 4.13	112.0 4.41	3.0 0.12	142.0 5.59	134.0 5.28	2.8 0.11	3.0 0.12	129.7	37.2	0.1386	1.67 3.68
28.971 1.1406	24.608 0.9688	3.0 0.12	3.5 0.14	105.0 4.13	112.0 4.41	3.3 0.13	142.0 5.59	134.0 5.28	2.8 0.11	3.0 0.12	129.7	37.2	0.1386	1.82 4.02
46.038 1.8125	31.750 1.2500	12.7 0.50	3.5 0.14	113.0 4.44	125.0 4.92	3.3 0.13	179.0 7.06	161.0 6.34	11.0 0.43	3.7 0.15	149.6	23.8	0.1180	5.59 12.33
36.116 1.4219	26.195 1.0313	-0.5 -0.02	3.5 0.14	108.0 4.25	114.0 4.49	3.3 0.13	152.0 5.98	142.0 5.59	4.4 0.17	2.5 0.10	175.4	41.7	0.1519	2.53 5.57
36.116 1.4219	26.195 1.0313	-0.5 -0.02	3.5 0.14	108.0 4.25	114.0 4.49	3.3 0.13	154.0 6.06	144.0 5.67	4.4 0.17	2.5 0.10	175.4	41.7	0.1519	2.76 6.08
41.275 1.6250	30.162 1.1875	-2.8 -0.11	3.5 0.14	109.0 4.29	116.0 4.57	3.3 0.13	160.0 6.30	149.0 5.87	4.9 0.19	2.1 0.08	182.5	37.3	0.1056	3.55 7.80
48.006 1.8900	38.100 1.5000	-8.1 -0.32	3.5 0.14	110.0 4.33	116.0 4.57	3.3 0.13	168.0 6.61	161.0 6.34	3.6 0.14	1.3 0.05	227.3	41.3	0.1067	5.21 11.49
63.500 2.5000	52.388 2.0625	-16.8 -0.66	6.4 0.25	115.1 4.53	127.0 5.00	3.3 0.13	176.0 6.93	163.0 6.42	3.1 0.12	3.1 0.13	298.2	40.9	0.1162	7.43 16.38

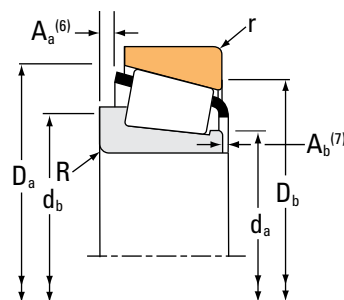
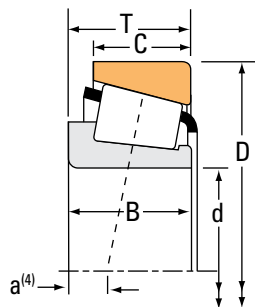
(4) Negative value indicates effective center inside cone (inner-ring) backface.  
 (5) These maximum fillet radii will be cleared by the bearing corners.  
 (6) Negative value indicates cage extends beyond cone (inner-ring) backface.  
 (7) Negative value indicates cage that does not extend beyond cone (inner-ring) front face.

Continued on next page.

# TAPERED ROLLER BEARINGS

## SINGLE-ROW • TYPE TS

### TYPE TS



Bearing Dimensions			Load Ratings							Part Number			
Bore d	O.D. D	Width T	Dynamic <sup>(1)</sup>		Factors <sup>(2)</sup>		Dynamic <sup>(3)</sup>		Factors <sup>(2)</sup>		Static C <sub>0</sub>	Inner	Outer
			C <sub>1</sub>	e	Y	C <sub>90</sub>	C <sub>a90</sub>	K	N	N			
mm in.	mm in.	mm in.	N lbf			N lbf	N lbf		N lbf				
98.425 3.8750	190.500 7.5000	57.150 2.2500	534000 120000	0.33	1.79	138000 31100	79300 17800	1.74	692000 156000			HH221442	HH221410
98.425 3.8750	212.725 8.3750	66.675 2.6250	680000 153000	0.33	1.84	176000 39600	98300 22100	1.79	906000 204000			HH224332	HH224310
99.975 3.9360	156.975 6.1801	42.000 1.6535	300000 67500	0.33	1.80	77800 17500	44300 9960	1.76	438000 98500			HM220149	HM220110
99.975 3.9360	214.975 8.4636	64.798 2.5511	680000 153000	0.33	1.84	176000 39600	98300 22100	1.79	906000 204000			HH224334	HH224314
100.000 3.9370	145.000 5.7087	24.000 0.9449	125000 28200	0.47	1.27	32500 7310	26300 5920	1.24	172000 38700			JP10049A	JP10010
100.000 3.9370	145.000 5.7087	24.000 0.9449	125000 28200	0.47	1.27	32500 7310	26300 5920	1.24	172000 38700			JP10049	JP10010A
100.000 3.9370	145.000 5.7087	24.000 0.9449	125000 28200	0.47	1.27	32500 7310	26300 5920	1.24	172000 38700			JP10049	JP10010
100.000 3.9370	150.000 5.9055	32.000 1.2598	162000 36500	0.50	1.20	42100 9470	36200 8130	1.16	242000 54400			JLM820048	JLM820012
100.000 3.9370	155.000 6.1024	36.000 1.4173	231000 52000	0.47	1.27	60000 13500	48600 10900	1.24	355000 79900			JM720249	JM720210
100.000 3.9370	160.000 6.2992	36.512 1.4375	211000 47400	0.47	1.26	54700 12300	44500 10000	1.23	343000 77000			52394X	52630X
100.000 3.9370	160.000 6.2992	41.000 1.6142	279000 62800	0.47	1.28	72400 16300	58300 13100	1.24	416000 93500			JHM720249	JHM720210
100.000 3.9370	180.000 7.0866	48.000 1.8898	346000 77800	0.39	1.56	89700 20200	59200 13300	1.51	495000 111000			783	773
100.000 3.9370	180.975 7.1250	47.625 1.8750	346000 77800	0.39	1.56	89700 20200	59200 13300	1.51	495000 111000			783	772
100.000 3.9370	200.000 7.8740	52.761 2.0772	482000 108000	0.63	0.95	125000 28100	135000 30400	0.92	519000 117000			98394X	98788
100.000 3.9370	215.000 8.4646	66.675 2.6250	642000 144000	0.33	1.84	166000 37400	92800 20900	1.79	906000 204000			JHH224333	JHH224315
100.012 3.9375	157.162 6.1875	36.512 1.4375	223000 50200	0.47	1.26	57900 13000	47100 10600	1.23	343000 77000			52393	52618
100.012 3.9375	161.925 6.3750	36.512 1.4375	223000 50200	0.47	1.26	57900 13000	47100 10600	1.23	343000 77000			52393	52637

<sup>(1)</sup>Based on 1 x 10<sup>6</sup> revolutions L<sub>10</sub> life, for the ISO life-calculation method.

<sup>(2)</sup>Consult your Timken engineer for instructions on use or review the Timken Engineering Manual on timken.com/catalogs.

<sup>(3)</sup>Based on 90 x 10<sup>6</sup> revolutions L<sub>10</sub> life, for The Timken Company life-calculation method. C<sub>90</sub> and C<sub>a90</sub> are radial and thrust values.

Bearing Dimensions											Geometry Factors			Bearing Weight
Width B	Width C	Eff. Ctr. a <sup>(4)</sup>	Shaft			Housing			Cage		G <sub>1</sub>	G <sub>2</sub>	C <sub>g</sub>	
			Max Shaft Fillet Radius R <sup>(5)</sup>	Backing Shoulder Dia. d <sub>a</sub>	Backing Shoulder Dia. d <sub>b</sub>	Max Housing Fillet Radius r <sup>(5)</sup>	Backing Shoulder Dia. D <sub>a</sub>	Backing Shoulder Dia. D <sub>b</sub>	A <sub>a</sub> <sup>(6)</sup>	A <sub>b</sub> <sup>(7)</sup>				
mm in.	mm in.	mm in.	mm in.	mm in.	mm in.	mm in.	mm in.	mm in.	mm in.	mm in.				kg lbs.
57.531 2.2650	46.038 1.8125	-15.0 -0.59	3.5 0.14	113.0 4.45	119.0 4.69	3.3 0.13	179.0 7.05	171.0 6.73	2.5 0.10	3.2 0.13	265.6	28.4	0.1072	7.22 15.92
66.675 2.6250	53.975 2.1250	-18.8 -0.74	3.5 0.14	119.0 4.69	123.0 4.84	3.3 0.13	201.7 7.94	192.0 7.56	4.8 0.19	2.9 0.12	366.6	47.9	0.1182	11.36 25.03
42.000 1.6535	34.000 1.3386	-8.6 -0.34	8.0 0.31	108.0 4.25	122.9 4.84	3.5 0.14	151.0 5.94	142.0 5.59	2.1 0.08	2.4 0.10	203.6	45.9	0.0981	2.79 6.15
66.675 2.6250	50.800 2.0000	-18.8 -0.74	3.5 0.14	120.0 4.72	124.0 4.88	3.3 0.13	201.2 7.92	192.0 7.56	4.8 0.19	2.9 0.12	366.6	47.9	0.1182	11.34 25.00
22.500 0.8858	17.500 0.6890	6.1 0.24	5.0 0.20	106.0 4.17	116.0 4.57	3.0 0.12	140.0 5.51	134.0 5.28	1.9 0.07	3.3 0.13	104.0	40.9	0.1264	1.13 2.49
22.500 0.8858	17.500 0.6890	6.1 0.24	3.0 0.12	106.0 4.17	112.0 4.41	0.8 0.03	140.0 5.51	136.0 5.35	1.9 0.07	3.3 0.13	104.0	40.9	0.1264	1.15 2.54
22.500 0.8858	17.500 0.6890	6.1 0.24	3.0 0.12	106.0 4.17	112.0 4.41	3.0 0.12	140.0 5.51	134.0 5.28	1.9 0.07	3.3 0.13	104.0	40.9	0.1264	1.13 2.49
30.000 1.1811	26.000 1.0236	4.6 0.18	2.3 0.09	107.0 4.21	111.0 4.37	2.3 0.09	144.0 5.67	135.0 5.31	2.3 0.09	1.0 0.04	133.1	38.3	0.1405	1.81 3.99
35.000 1.3780	28.000 1.1024	0.3 0.01	3.0 0.12	109.0 4.29	115.0 4.53	2.5 0.10	149.0 5.87	140.0 5.51	3.0 0.12	3.1 0.12	174.8	48.5	0.1043	2.36 5.20
36.116 1.4219	26.195 1.0313	-0.5 -0.02	3.5 0.14	109.0 4.29	116.0 4.57	3.0 0.12	153.0 6.02	144.0 5.67	4.4 0.17	2.5 0.10	175.4	41.7	0.1519	2.59 5.72
40.000 1.5748	32.000 1.2598	-2.5 -0.10	3.0 0.12	109.4 4.30	117.0 4.61	2.5 0.10	153.9 6.06	143.0 5.63	3.3 0.13	3.7 0.15	187.7	45.3	0.1068	3.00 6.60
48.006 1.8900	40.000 1.5748	-8.1 -0.32	3.5 0.14	111.0 4.37	118.0 4.65	3.0 0.12	168.0 6.61	160.0 6.30	3.6 0.14	1.3 0.05	227.3	41.3	0.1067	5.09 11.22
48.006 1.8900	38.100 1.5000	-8.1 -0.32	3.5 0.14	111.0 4.37	118.0 4.65	3.3 0.13	168.0 6.61	161.0 6.34	3.6 0.14	1.3 0.05	227.3	41.3	0.1067	5.12 11.29
49.212 1.9375	34.925 1.3750	1.3 0.05	3.5 0.14	120.6 4.75	126.0 4.96	3.3 0.13	188.0 7.40	174.0 6.85	8.6 0.34	5.4 0.22	203.4	37.5	0.1197	6.85 15.11
66.675 2.6250	53.975 2.1250	-18.9 -0.74	7.0 0.28	120.0 4.72	131.0 5.16	3.3 0.13	201.7 7.94	193.0 7.60	4.8 0.19	2.9 0.12	366.6	47.9	0.1182	11.52 25.40
36.116 1.4219	26.195 1.0313	-0.5 -0.02	3.5 0.14	109.0 4.29	116.0 4.57	3.3 0.13	152.0 5.98	142.0 5.59	4.4 0.17	2.5 0.10	175.4	41.7	0.1519	2.46 5.42
36.116 1.4219	26.195 1.0313	-0.5 -0.02	3.5 0.14	109.0 4.29	116.0 4.57	3.3 0.13	154.0 6.06	144.0 5.67	4.4 0.17	2.5 0.10	175.4	41.7	0.1519	2.69 5.93

<sup>(4)</sup>Negative value indicates effective center inside cone (inner-ring) backface.

<sup>(5)</sup>These maximum fillet radii will be cleared by the bearing corners.

<sup>(6)</sup>Negative value indicates cage extends beyond cone (inner-ring) backface.

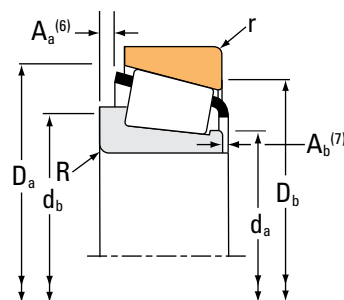
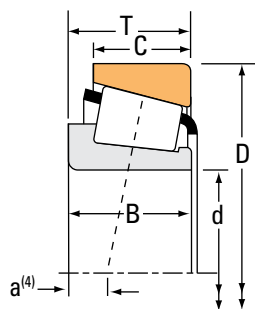
<sup>(7)</sup>Negative value indicates cage that does not extend beyond cone (inner-ring) front face.

*Continued on next page.*

# TAPERED ROLLER BEARINGS

SINGLE-ROW • TYPE TS

## TYPE TS



Bearing Dimensions			Load Ratings							Part Number		
Bore d	O.D. D	Width T	Dynamic <sup>(1)</sup>		Factors <sup>(2)</sup>		Dynamic <sup>(3)</sup>		Factors <sup>(2)</sup>	Static	Inner	Outer
			C <sub>1</sub>	e	Y	C <sub>90</sub>	C <sub>a90</sub>	K	C <sub>0</sub>			
mm in.	mm in.	mm in.	N lbf			N lbf	N lbf			N lbf		
100.012 3.9375	161.925 6.3750	39.687 1.5625	223000 50200	0.47	1.26	57900 13000	47100 10600	1.23		343000 77000	52393	52638
101.600 4.0000	134.938 5.3125	15.875 0.6250	64900 14600	0.37	1.62	16800 3780	10700 2400	1.58		104000 23400	LL420549	LL420510
101.600 4.0000	136.525 5.3750	21.433 0.8438	97800 22000	0.37	1.63	25400 5700	16000 3600	1.59		175000 39400	L420449	L420410
101.600 4.0000	146.050 5.7500	21.433 0.8438	96000 21600	0.39	1.53	24900 5600	16700 3760	1.49		175000 39400	L521945	L521910
101.600 4.0000	146.050 5.7500	25.400 1.0000	132000 29600	0.46	1.31	34100 7670	26800 6020	1.27		202000 45400	LM720648	LM720610
101.600 4.0000	152.400 6.0000	21.433 0.8438	96000 21600	0.39	1.53	24900 5600	16700 3760	1.49		175000 39400	L521945	L521914
101.600 4.0000	157.162 6.1875	36.512 1.4375	223000 50200	0.47	1.26	57900 13000	47100 10600	1.23		343000 77000	52400	52618
101.600 4.0000	157.162 6.1875	36.512 1.4375	223000 50200	0.47	1.26	57900 13000	47100 10600	1.23		343000 77000	52401	52618
101.600 4.0000	160.000 6.2992	36.512 1.4375	223000 50200	0.47	1.26	57900 13000	47100 10600	1.23		343000 77000	52400	52630X
101.600 4.0000	161.925 6.3750	36.512 1.4375	223000 50200	0.47	1.26	57900 13000	47100 10600	1.23		343000 77000	52400	52637
101.600 4.0000	161.925 6.3750	39.687 1.5625	223000 50200	0.47	1.26	57900 13000	47100 10600	1.23		343000 77000	52400	52638
101.600 4.0000	168.275 6.6250	41.275 1.6250	265000 59500	0.47	1.28	68600 15400	55300 12400	1.24		386000 86700	687	672
101.600 4.0000	168.275 6.6250	41.275 1.6250	265000 59500	0.47	1.28	68600 15400	55300 12400	1.24		386000 86700	687	672A
101.600 4.0000	171.450 6.7500	41.275 1.6250	265000 59500	0.47	1.28	68600 15400	55300 12400	1.24		386000 86700	687	674
101.600 4.0000	177.800 7.0000	34.925 1.3750	170000 38300	1.17	0.51	44200 9930	88600 19900	0.50		219000 49200	LM921845	LM921810
101.600 4.0000	180.000 7.0866	48.000 1.8898	346000 77800	0.39	1.56	89700 20200	59200 13300	1.51		495000 111000	780	773
101.600 4.0000	180.975 7.1250	47.625 1.8750	346000 77800	0.39	1.56	89700 20200	59200 13300	1.51		495000 111000	780	772

<sup>(1)</sup>Based on 1 x 10<sup>6</sup> revolutions L<sub>10</sub> life, for the ISO life-calculation method.

<sup>(2)</sup>Consult your Timken engineer for instructions on use or review the Timken Engineering Manual on timken.com/catalogs.

<sup>(3)</sup>Based on 90 x 10<sup>6</sup> revolutions L<sub>10</sub> life, for The Timken Company life-calculation method. C<sub>90</sub> and C<sub>a90</sub> are radial and thrust values.

Bearing Dimensions											Geometry Factors			Bearing Weight
Width B	Width C	Eff. Ctr. a <sup>(4)</sup>	Shaft			Housing			Cage		G <sub>1</sub>	G <sub>2</sub>	C <sub>g</sub>	
			Max Shaft Fillet Radius R <sup>(5)</sup>	Backing Shoulder Dia. d <sub>a</sub>	Backing Shoulder Dia. d <sub>b</sub>	Max Housing Fillet Radius r <sup>(5)</sup>	Backing Shoulder Dia. D <sub>a</sub>	Backing Shoulder Dia. D <sub>b</sub>	A <sub>a</sub> <sup>(6)</sup>	A <sub>b</sub> <sup>(7)</sup>				
mm in.	mm in.	mm in.	mm in.	mm in.	mm in.	mm in.	mm in.	mm in.	mm in.	mm in.				kg lbs.
36.116 1.4219	29.370 1.1563	-0.5 -0.02	3.5 0.14	109.0 4.29	116.0 4.57	3.3 0.13	154.0 6.06	143.0 5.63	4.4 0.17	2.5 0.10	175.4	41.7	0.1519	2.86 6.29
15.083 0.5938	11.908 0.4688	5.6 0.22	1.5 0.06	107.0 4.21	109.0 4.29	1.5 0.06	130.0 5.12	128.0 5.04	1.0 0.04	2.1 0.09	95.5	89.8	0.1126	0.56 1.25
21.433 0.8438	16.670 0.6563	2.8 0.11	1.5 0.06	107.0 4.21	109.0 4.29	1.5 0.06	132.0 5.20	128.0 5.04	0.7 0.02	1.6 0.07	139.9	102.5	0.1286	0.84 1.86
21.433 0.8438	16.670 0.6563	4.8 0.19	1.5 0.06	109.0 4.29	112.0 4.41	1.5 0.06	141.0 5.55	136.0 5.35	0.7 0.03	1.6 0.07	152.1	107.9	0.1346	1.15 2.56
25.400 1.0000	19.050 0.7500	4.8 0.19	1.5 0.06	109.0 4.29	110.0 4.33	1.5 0.06	141.0 5.55	136.0 5.35	2.4 0.09	1.1 0.05	127.6	62.7	0.1342	1.29 2.84
21.433 0.8438	16.670 0.6563	4.8 0.19	1.5 0.06	109.0 4.29	112.0 4.41	1.5 0.06	144.0 5.67	139.0 5.47	0.7 0.03	1.6 0.07	152.1	107.9	0.1346	1.35 2.99
36.116 1.4219	26.195 1.0313	-0.5 -0.02	3.5 0.14	111.0 4.37	117.0 4.61	3.3 0.13	152.0 5.98	142.0 5.59	4.4 0.17	2.5 0.10	175.4	41.7	0.1519	2.40 5.28
36.116 1.4219	26.195 1.0313	-0.5 -0.02	8.0 0.31	112.0 4.41	128.0 5.04	3.3 0.13	152.0 5.98	142.0 5.59	4.4 0.17	2.5 0.10	175.4	41.7	0.1519	2.37 5.22
36.116 1.4219	26.195 1.0313	-0.5 -0.02	3.5 0.14	111.0 4.37	117.0 4.61	3.0 0.12	153.0 6.02	144.0 5.67	4.4 0.17	2.5 0.10	175.4	41.7	0.1519	2.53 5.58
36.116 1.4219	26.195 1.0313	-0.5 -0.02	3.5 0.14	111.0 4.37	117.0 4.61	3.3 0.13	154.0 6.06	144.0 5.67	4.4 0.17	2.5 0.10	175.4	41.7	0.1519	2.63 5.79
36.116 1.4219	29.370 1.1563	-0.5 -0.02	3.5 0.14	111.0 4.37	117.0 4.61	3.3 0.13	154.0 6.06	143.0 5.63	4.4 0.17	2.5 0.10	175.4	41.7	0.1519	2.80 6.16
41.275 1.6250	30.162 1.1875	-2.8 -0.11	3.5 0.14	112.0 4.41	118.0 4.65	3.3 0.13	160.0 6.30	149.0 5.87	4.9 0.19	2.1 0.08	182.5	37.3	0.1056	3.38 7.45
41.275 1.6250	34.925 1.3750	-2.8 -0.11	3.5 0.14	112.0 4.41	118.0 4.65	3.3 0.13	160.0 6.30	149.0 5.87	4.9 0.19	2.1 0.08	182.5	37.3	0.1056	3.46 7.64
41.275 1.6250	30.162 1.1875	-2.8 -0.11	3.5 0.14	112.0 4.41	118.0 4.65	3.3 0.13	160.0 6.30	150.0 5.91	4.9 0.19	2.1 0.08	182.5	37.3	0.1056	3.54 7.81
31.750 1.2500	19.050 0.7500	34.5 1.36	3.3 0.13	119.0 4.69	128.0 5.04	3.3 0.13	172.0 6.77	154.0 6.06	8.9 0.35	3.3 0.13	113.7	37.5	0.1153	3.09 6.83
48.006 1.8900	40.000 1.5748	-8.1 -0.32	3.5 0.14	113.0 4.45	119.0 4.69	3.0 0.12	168.0 6.61	160.0 6.30	3.6 0.14	1.3 0.05	227.3	41.3	0.1067	4.99 11.01
48.006 1.8900	38.100 1.5000	-8.1 -0.32	3.5 0.14	113.0 4.45	119.0 4.69	3.3 0.13	168.0 6.61	161.0 6.34	3.6 0.14	1.3 0.05	227.3	41.3	0.1067	5.02 11.08

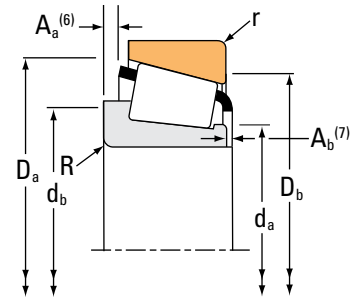
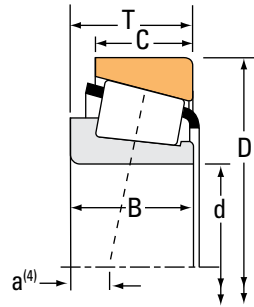
(4) Negative value indicates effective center inside cone (inner-ring) backface.  
 (5) These maximum fillet radii will be cleared by the bearing corners.  
 (6) Negative value indicates cage extends beyond cone (inner-ring) backface.  
 (7) Negative value indicates cage that does not extend beyond cone (inner-ring) front face.

Continued on next page.

# TAPERED ROLLER BEARINGS

## SINGLE-ROW • TYPE TS

### TYPE TS



Bearing Dimensions			Load Ratings							Part Number			
Bore d	O.D. D	Width T	Dynamic <sup>(1)</sup>		Factors <sup>(2)</sup>		Dynamic <sup>(3)</sup>		Factors <sup>(2)</sup>		Static C <sub>0</sub>	Inner	Outer
			C <sub>1</sub>	e	Y	C <sub>90</sub>	C <sub>a90</sub>	K	N	N			
mm in.	mm in.	mm in.	N lbf			N lbf	N lbf		N lbf				
101.600 4.0000	190.500 7.5000	57.150 2.2500	458000 103000	0.33	1.79	119000 26700	68000 15300	1.74	630000 142000		861	854	
101.600 4.0000	190.500 7.5000	57.150 2.2500	534000 120000	0.33	1.79	138000 31100	79300 17800	1.74	692000 156000		HH221449	HH221410	
101.600 4.0000	190.500 7.5000	57.150 2.2500	534000 120000	0.33	1.79	138000 31100	79300 17800	1.74	692000 156000		HH221449A	HH221410	
101.600 4.0000	200.000 7.8740	52.761 2.0772	482000 108000	0.63	0.95	125000 28100	135000 30400	0.92	519000 117000		98400	98788	
101.600 4.0000	212.725 8.3750	66.675 2.6250	572000 129000	0.33	1.84	148000 33300	82700 18600	1.79	786000 177000		941	932	
101.600 4.0000	212.725 8.3750	66.675 2.6250	680000 153000	0.33	1.84	176000 39600	98300 22100	1.79	906000 204000		HH224335	HH224310	
101.600 4.0000	214.312 8.4375	55.562 2.1875	557000 125000	0.67	0.89	144000 32500	167000 37500	0.87	610000 137000		H924033	H924010	
101.600 4.0000	214.975 8.4636	64.798 2.5511	680000 153000	0.33	1.84	176000 39600	98300 22100	1.79	906000 204000		HH224335	HH224314	
101.600 4.0000	250.825 9.8750	76.200 3.0000	828000 186000	0.70	0.86	215000 48200	257000 57800	0.84	827000 186000		HH923649	HH923611	
103.188 4.0625	171.450 6.7500	41.275 1.6250	265000 59500	0.47	1.28	68600 15400	55300 12400	1.24	386000 86700		689	674	
104.775 4.1250	142.083 5.5938	15.875 0.6250	61400 13800	0.39	1.53	15900 3580	10700 2400	1.49	107000 24000		LL521845	LL521810	
104.775 4.1250	180.975 7.1250	47.625 1.8750	346000 77800	0.39	1.56	89700 20200	59200 13300	1.51	495000 111000		782	772	
104.775 4.1250	180.975 7.1250	47.625 1.8750	346000 77800	0.39	1.56	89700 20200	59200 13300	1.51	495000 111000		786	772	
104.775 4.1250	180.975 7.1250	47.625 1.8750	346000 77800	0.39	1.56	89700 20200	59200 13300	1.51	495000 111000		787	772	
104.775 4.1250	190.500 7.5000	47.625 1.8750	364000 81700	0.42	1.44	94300 21200	67100 15100	1.40	543000 122000		71412	71750	
106.362 4.1875	165.100 6.5000	36.512 1.4375	226000 50900	0.50	1.21	58700 13200	50000 11200	1.18	355000 79700		56418	56650	
106.975 4.2116	146.975 5.7864	28.500 1.1220	171000 38400	0.27	2.23	44300 9960	20400 4590	2.17	285000 64100		LM121349	LM121310	

<sup>(1)</sup>Based on 1 x 10<sup>6</sup> revolutions L<sub>10</sub> life, for the ISO life-calculation method.

<sup>(2)</sup>Consult your Timken engineer for instructions on use or review the Timken Engineering Manual on timken.com/catalogs.

<sup>(3)</sup>Based on 90 x 10<sup>6</sup> revolutions L<sub>10</sub> life, for The Timken Company life-calculation method. C<sub>90</sub> and C<sub>a90</sub> are radial and thrust values.



Bearing Dimensions											Geometry Factors			Bearing Weight
Width B	Width C	Eff. Ctr. a <sup>(4)</sup>	Shaft			Housing			Cage		G <sub>1</sub>	G <sub>2</sub>	C <sub>g</sub>	
			Max Shaft Fillet Radius R <sup>(5)</sup>	Backing Shoulder Dia. d <sub>a</sub>	Backing Shoulder Dia. d <sub>b</sub>	Max Housing Fillet Radius r <sup>(5)</sup>	Backing Shoulder Dia. D <sub>a</sub>	Backing Shoulder Dia. D <sub>b</sub>	A <sub>a</sub> <sup>(6)</sup>	A <sub>b</sub> <sup>(7)</sup>				
mm in.	mm in.	mm in.	mm in.	mm in.	mm in.	mm in.	mm in.	mm in.	mm in.	mm in.				kg lbs.
57.531 2.2650	44.450 1.7500	-15.2 -0.60	8.0 0.31	114.0 4.49	129.0 5.08	3.3 0.13	174.0 6.85	170.0 6.69	5.5 0.22	0.7 0.03	264.1	44.9	0.1072	6.83 15.07
57.531 2.2650	46.038 1.8125	-15.0 -0.59	8.0 0.31	115.9 4.56	131.0 5.16	3.3 0.13	179.0 7.05	171.0 6.73	2.5 0.10	3.2 0.13	265.6	28.4	0.1072	6.97 15.38
57.531 2.2650	46.038 1.8125	-15.0 -0.59	3.5 0.14	115.9 4.56	122.0 4.80	3.3 0.13	179.0 7.05	171.0 6.73	2.5 0.10	3.2 0.13	265.6	28.4	0.1072	7.00 15.42
49.212 1.9375	34.925 1.3750	1.3 0.05	3.5 0.14	120.6 4.75	128.0 5.04	3.3 0.13	188.0 7.40	174.0 6.85	8.6 0.34	5.4 0.22	203.4	37.5	0.1197	6.75 14.89
66.675 2.6250	53.975 2.1250	-19.8 -0.78	7.0 0.28	117.0 4.61	130.0 5.12	3.3 0.13	193.1 7.60	187.0 7.36	6.6 0.26	1.3 0.05	338.6	39.8	0.1153	10.96 24.17
66.675 2.6250	53.975 2.1250	-18.8 -0.74	7.0 0.28	121.0 4.76	132.0 5.20	3.3 0.13	201.7 7.94	192.0 7.56	4.8 0.19	2.9 0.12	366.6	47.9	0.1182	11.07 24.41
52.388 2.0625	39.688 1.5625	6.9 0.27	3.5 0.14	128.0 5.04	132.0 5.20	3.3 0.13	205.0 8.07	186.0 7.32	6.6 0.26	3.4 0.14	245.6	32.2	0.1299	8.97 19.79
66.675 2.6250	50.800 2.0000	-18.8 -0.74	7.0 0.28	121.0 4.76	132.0 5.20	3.3 0.13	201.2 7.92	192.0 7.56	4.8 0.19	2.9 0.12	366.6	47.9	0.1182	11.18 24.65
73.025 2.8750	50.800 2.0000	-3.3 -0.13	6.4 0.25	130.8 5.15	149.0 5.87	3.3 0.13	228.8 9.01	210.0 8.27	15.1 0.59	4.6 0.19	282.1	35.2	0.1370	17.11 37.71
41.275 1.6250	30.162 1.1875	-2.8 -0.11	3.5 0.14	113.5 4.46	123.0 4.84	3.3 0.13	160.0 6.30	150.0 5.91	4.9 0.19	2.1 0.08	182.5	37.3	0.1056	3.46 7.62
15.083 0.5938	11.908 0.4688	7.4 0.29	1.5 0.06	111.0 4.37	113.0 4.45	1.5 0.06	137.0 5.39	135.0 5.31	0.7 0.03	2.2 0.09	104.7	110.1	0.1179	0.68 1.50
48.006 1.8900	38.100 1.5000	-8.1 -0.32	3.5 0.14	116.0 4.57	122.0 4.80	3.3 0.13	168.0 6.61	161.0 6.34	3.6 0.14	1.3 0.05	227.3	41.3	0.1067	4.83 10.65
48.006 1.8900	38.100 1.5000	-8.1 -0.32	6.4 0.25	116.0 4.57	128.0 5.04	3.3 0.13	168.0 6.61	161.0 6.34	3.6 0.14	1.3 0.05	227.3	41.3	0.1067	4.79 10.57
48.006 1.8900	38.100 1.5000	-8.1 -0.32	7.0 0.28	116.0 4.57	129.0 5.08	3.3 0.13	168.0 6.61	161.0 6.34	3.6 0.14	1.3 0.05	227.3	41.3	0.1067	4.77 10.53
49.212 1.9375	34.925 1.3750	-6.6 -0.26	3.5 0.14	118.0 4.65	124.0 4.88	3.3 0.13	181.0 7.13	171.0 6.73	5.3 0.21	1.5 0.06	269.2	49.5	0.1156	5.78 12.75
36.512 1.4375	26.988 1.0625	2.0 0.08	3.5 0.14	116.0 4.57	122.0 4.80	3.3 0.13	159.0 6.26	149.0 5.87	3.9 0.15	1.5 0.06	190.9	47.7	0.1584	2.71 5.96
28.000 1.1024	24.000 0.9449	-3.8 -0.15	2.3 0.09	112.0 4.41	116.0 4.57	2.3 0.09	142.0 5.59	138.0 5.43	0.5 0.02	2.4 0.10	195.2	75.6	0.1302	1.33 2.92

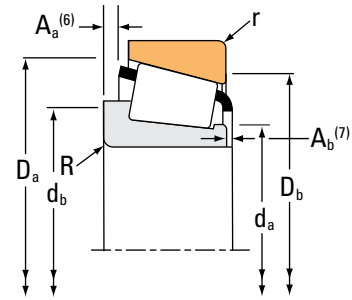
<sup>(4)</sup>Negative value indicates effective center inside cone (inner-ring) backface.  
<sup>(5)</sup>These maximum fillet radii will be cleared by the bearing corners.  
<sup>(6)</sup>Negative value indicates cage extends beyond cone (inner-ring) backface.  
<sup>(7)</sup>Negative value indicates cage that does not extend beyond cone (inner-ring) front face.

Continued on next page.

# TAPERED ROLLER BEARINGS

## SINGLE-ROW • TYPE TS

### TYPE TS



Bearing Dimensions			Load Ratings							Part Number			
Bore d	O.D. D	Width T	Dynamic <sup>(1)</sup>		Factors <sup>(2)</sup>		Dynamic <sup>(3)</sup>		Factors <sup>(2)</sup>		Static C <sub>0</sub>	Inner	Outer
			C <sub>1</sub>	e	Y	C <sub>90</sub>	C <sub>a90</sub>	K	N	N			
mm in.	mm in.	mm in.	N lbf			N lbf	N lbf		N lbf				
107.950 4.2500	142.083 5.5938	15.875 0.6250	70400 15800	0.39	1.53	18200 4100	12200 2750	1.49	107000 24000		LL521849C	LL521810	
107.950 4.2500	146.050 5.7500	21.433 0.8438	88900 20000	0.39	1.53	23100 5180	15500 3480	1.49	175000 39400		L521949	L521910	
107.950 4.2500	152.400 6.0000	21.433 0.8438	88900 20000	0.39	1.53	23100 5180	15500 3480	1.49	175000 39400		L521949	L521914	
107.950 4.2500	158.750 6.2500	23.020 0.9063	137000 30700	0.61	0.99	35400 7960	36700 8250	0.96	179000 40100		37425	37625	
107.950 4.2500	159.987 6.2987	34.925 1.3750	232000 52200	0.40	1.49	60100 13500	41400 9300	1.45	357000 80300		LM522546	LM522510	
107.950 4.2500	161.925 6.3750	34.925 1.3750	192000 43200	0.51	1.19	49800 11200	43100 9680	1.16	308000 69200		48190	48120	
107.950 4.2500	165.100 6.5000	36.512 1.4375	226000 50900	0.50	1.21	58700 13200	50000 11200	1.18	355000 79700		56425	56650	
107.950 4.2500	165.100 6.5000	36.512 1.4375	226000 50900	0.50	1.21	58700 13200	50000 11200	1.18	355000 79700		56426	56650	
107.950 4.2500	168.275 6.6250	36.512 1.4375	226000 50900	0.50	1.21	58700 13200	50000 11200	1.18	355000 79700		56425	56662	
107.950 4.2500	171.450 6.7500	34.000 1.3386	233000 52500	0.47	1.27	60500 13600	49000 11000	1.24	268000 60300		67425	67675	
107.950 4.2500	190.500 7.5000	47.625 1.8750	364000 81700	0.42	1.44	94300 21200	67100 15100	1.40	543000 122000		71425	71750	
107.950 4.2500	212.725 8.3750	66.675 2.6250	572000 129000	0.33	1.84	148000 33300	82700 18600	1.79	786000 177000		936	932	
107.950 4.2500	212.725 8.3750	66.675 2.6250	680000 153000	0.33	1.84	176000 39600	98300 22100	1.79	906000 204000		HH224340	HH224310	
109.538 4.3125	158.750 6.2500	23.020 0.9063	115000 25900	0.61	0.99	29900 6710	31000 6960	0.96	179000 40100		37431	37625	
109.538 4.3125	158.750 6.2500	23.020 0.9063	137000 30700	0.61	0.99	35400 7960	36700 8250	0.96	179000 40100		37431A	37625	
109.952 4.3288	190.500 7.5000	47.625 1.8750	364000 81700	0.42	1.44	94300 21200	67100 15100	1.40	543000 122000		71432	71750	
109.975 4.3297	179.975 7.0856	41.275 1.6250	275000 61800	0.52	1.16	71200 16000	62900 14100	1.13	419000 94200		64432	64708	

<sup>(1)</sup>Based on  $1 \times 10^6$  revolutions  $L_{10}$  life, for the ISO life-calculation method.

<sup>(2)</sup>Consult your Timken engineer for instructions on use or review the Timken Engineering Manual on [timken.com/catalogs](http://timken.com/catalogs).

<sup>(3)</sup>Based on  $90 \times 10^6$  revolutions  $L_{10}$  life, for The Timken Company life-calculation method.  $C_{90}$  and  $C_{a90}$  are radial and thrust values.

Bearing Dimensions											Geometry Factors			Bearing Weight
Width B	Width C	Eff. Ctr. a <sup>(4)</sup>	Shaft			Housing			Cage		G <sub>1</sub>	G <sub>2</sub>	C <sub>g</sub>	
			Max Shaft Fillet Radius R <sup>(5)</sup>	Backing Shoulder Dia. d <sub>a</sub>	mm d <sub>b</sub>	Max Housing Fillet Radius r <sup>(5)</sup>	Backing Shoulder Dia. D <sub>a</sub>	mm D <sub>b</sub>	A <sub>a</sub> <sup>(6)</sup>	A <sub>b</sub> <sup>(7)</sup>				
mm in.	mm in.	mm in.	mm in.	mm in.	mm in.	mm in.	mm in.	mm in.	mm in.	mm in.				kg lbs.
15.083 0.5938	11.908 0.4688	7.4 0.29	1.5 0.06	113.0 4.45	115.0 4.53	1.5 0.06	137.0 5.39	135.0 5.31	0.7 0.03	2.2 0.09	104.7	110.1	0.1179	0.62 1.37
21.433 0.8438	16.670 0.6563	4.8 0.19	1.5 0.06	114.0 4.49	116.0 4.57	1.5 0.06	141.0 5.55	136.0 5.35	0.7 0.03	1.6 0.07	152.1	107.9	0.1346	0.98 2.17
21.433 0.8438	16.670 0.6563	4.8 0.19	1.5 0.06	114.0 4.49	116.0 4.57	1.5 0.06	144.0 5.67	139.0 5.47	0.7 0.03	1.6 0.07	152.1	107.9	0.1346	1.18 2.60
21.438 0.8440	15.875 0.6250	13.7 0.54	3.5 0.14	115.0 4.53	122.0 4.80	3.3 0.13	152.0 5.98	143.0 5.63	2.5 0.10	3.0 0.12	123.7	57.1	0.1443	1.37 3.01
34.925 1.3750	26.988 1.0625	-1.5 -0.06	3.5 0.14	116.0 4.57	122.0 4.80	3.3 0.13	154.0 6.06	146.0 5.75	2.4 0.09	1.4 0.06	231.6	63.4	0.1576	2.34 5.15
34.925 1.3750	26.988 1.0625	3.8 0.15	3.5 0.14	116.0 4.57	122.0 4.80	3.3 0.13	156.0 6.14	146.0 5.75	2.8 0.11	0.8 0.03	180.1	51.0	0.1558	2.34 5.17
36.512 1.4375	26.988 1.0625	2.0 0.08	3.5 0.14	117.0 4.61	123.0 4.84	3.3 0.13	159.0 6.26	149.0 5.87	3.9 0.15	1.5 0.06	190.9	47.7	0.1584	2.63 5.79
36.512 1.4375	26.988 1.0625	2.0 0.08	8.0 0.31	117.0 4.61	132.0 5.20	3.3 0.13	159.0 6.26	149.0 5.87	3.9 0.15	1.5 0.06	190.9	47.7	0.1584	2.60 5.73
36.512 1.4375	26.988 1.0625	2.0 0.08	3.5 0.14	117.0 4.61	123.0 4.84	3.3 0.13	161.0 6.34	151.0 5.94	3.9 0.15	1.5 0.06	190.9	47.7	0.1584	2.79 6.14
30.162 1.1875	25.268 0.9948	4.6 0.18	3.5 0.14	116.0 4.57	123.0 4.84	3.3 0.13	164.0 6.46	156.0 6.14	3.4 0.13	2.1 0.09	151.5	50.5	0.0987	2.54 5.58
49.212 1.9375	34.925 1.3750	-6.6 -0.26	3.6 0.14	120.0 4.72	126.0 4.96	3.3 0.13	181.0 7.13	171.0 6.73	5.3 0.21	1.5 0.06	269.2	49.5	0.1156	5.58 12.32
66.675 2.6250	53.975 2.1250	-19.8 -0.78	8.0 0.31	122.0 4.80	137.0 5.39	3.3 0.13	193.1 7.60	187.0 7.36	6.6 0.26	1.3 0.05	338.6	39.8	0.1153	10.40 22.92
66.675 2.6250	53.975 2.1250	-18.8 -0.74	8.0 0.31	126.0 4.96	139.0 5.47	3.3 0.13	201.7 7.94	192.0 7.56	4.8 0.19	2.9 0.12	366.6	47.9	0.1182	10.48 23.10
21.438 0.8440	15.875 0.6250	13.7 0.54	3.5 0.14	116.0 4.57	123.0 4.84	3.3 0.13	152.0 5.98	143.0 5.63	2.5 0.10	3.0 0.12	123.7	57.1	0.1443	1.33 2.93
21.438 0.8440	15.875 0.6250	13.7 0.54	5.0 0.20	117.0 4.61	126.0 4.96	3.3 0.13	152.0 5.98	143.0 5.63	2.5 0.10	3.0 0.12	123.7	57.1	0.1443	1.32 2.90
49.212 1.9375	34.925 1.3750	-6.6 -0.26	3.5 0.14	122.0 4.80	128.0 5.04	3.3 0.13	181.0 7.13	171.0 6.73	5.3 0.21	1.5 0.06	269.2	49.5	0.1156	5.44 12.00
41.275 1.6250	30.162 1.1875	1.3 0.05	3.5 0.14	121.0 4.76	128.0 5.04	3.3 0.13	173.0 6.81	161.0 6.34	5.2 0.20	2.1 0.08	218.8	45.3	0.1153	3.86 8.50

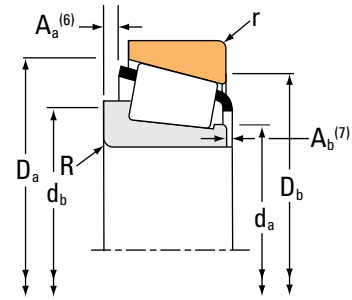
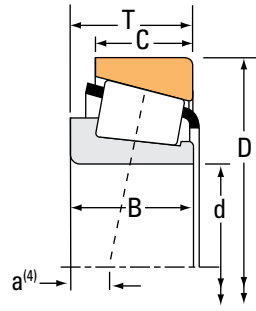
<sup>(4)</sup>Negative value indicates effective center inside cone (inner-ring) backface.  
<sup>(5)</sup>These maximum fillet radii will be cleared by the bearing corners.  
<sup>(6)</sup>Negative value indicates cage extends beyond cone (inner-ring) backface.  
<sup>(7)</sup>Negative value indicates cage that does not extend beyond cone (inner-ring) front face.

Continued on next page.

# TAPERED ROLLER BEARINGS

## SINGLE-ROW • TYPE TS

### TYPE TS



Bearing Dimensions			Load Ratings							Part Number			
Bore d	O.D. D	Width T	Dynamic <sup>(1)</sup>		Factors <sup>(2)</sup>		Dynamic <sup>(3)</sup>		Factors <sup>(2)</sup>		Static C <sub>0</sub>	Inner	Outer
			C <sub>1</sub>	e	Y	C <sub>90</sub>	C <sub>a90</sub>	K	N	N			
mm in.	mm in.	mm in.	N lbf			N lbf	N lbf		N lbf				
109.985 4.3301	214.312 8.4375	55.562 2.1875	470000 106000	0.67	0.89	122000 27400	141000 31600	0.87	610000 137000			H924043	H924010
109.987 4.3302	159.987 6.2987	34.925 1.3750	232000 52200	0.40	1.49	60100 13500	41400 9300	1.45	357000 80300			LM522549	LM522510
109.987 4.3302	159.987 6.2987	34.925 1.3750	196000 44000	0.40	1.49	50700 11400	34900 7850	1.45	357000 80300			LM522548	LM522510
109.992 4.3304	177.800 7.0000	41.275 1.6250	275000 61800	0.52	1.16	71200 16000	62900 14100	1.13	419000 94200			64433	64700
110.000 4.3307	165.000 6.4961	35.000 1.3780	227000 51100	0.50	1.21	58900 13200	50100 11300	1.18	356000 80100			JM822049	JM822010
110.000 4.3307	180.000 7.0866	47.000 1.8504	371000 83500	0.41	1.48	96300 21600	66900 15000	1.44	554000 125000			JHM522649A	JHM522610
110.000 4.3307	212.725 8.3750	66.675 2.6250	572000 129000	0.33	1.84	148000 33300	82700 18600	1.79	786000 177000			942	932
110.333 4.3438	171.450 6.7500	34.000 1.3386	197000 44300	0.47	1.27	51000 11500	41300 9290	1.24	268000 60300			67434	67675
111.125 4.3750	171.450 6.7500	34.000 1.3386	233000 52500	0.47	1.27	60500 13600	49000 11000	1.24	268000 60300			67437	67675
111.125 4.3750	190.500 7.5000	47.625 1.8750	364000 81700	0.42	1.44	94300 21200	67100 15100	1.40	543000 122000			71437	71750
111.125 4.3750	214.312 8.4375	55.562 2.1875	557000 125000	0.67	0.89	144000 32500	167000 37500	0.87	610000 137000			H924045	H924010
114.300 4.5000	152.400 6.0000	21.433 0.8438	118000 26600	0.41	1.45	30600 6890	21700 4870	1.41	188000 42300			L623149	L623110
114.300 4.5000	177.800 7.0000	41.275 1.6250	275000 61800	0.52	1.16	71200 16000	62900 14100	1.13	419000 94200			64450	64700
114.300 4.5000	178.000 7.0079	41.275 1.6250	275000 61800	0.52	1.16	71200 16000	62900 14100	1.13	419000 94200			64450	64701X
114.300 4.5000	179.975 7.0856	41.275 1.6250	275000 61800	0.52	1.16	71200 16000	62900 14100	1.13	419000 94200			64450	64708
114.300 4.5000	180.975 7.1250	41.275 1.6250	275000 61800	0.52	1.16	71200 16000	62900 14100	1.13	419000 94200			64450	64713
114.300 4.5000	190.500 7.5000	47.625 1.8750	364000 81700	0.42	1.44	94300 21200	67100 15100	1.40	543000 122000			71450	71750

<sup>(1)</sup>Based on 1 x 10<sup>6</sup> revolutions L<sub>10</sub> life, for the ISO life-calculation method.

<sup>(2)</sup>Consult your Timken engineer for instructions on use or review the Timken Engineering Manual on timken.com/catalogs.

<sup>(3)</sup>Based on 90 x 10<sup>6</sup> revolutions L<sub>10</sub> life, for The Timken Company life-calculation method. C<sub>90</sub> and C<sub>a90</sub> are radial and thrust values.

Bearing Dimensions											Geometry Factors			Bearing Weight
Width B	Width C	Eff. Ctr. a <sup>(4)</sup>	Shaft			Housing			Cage		G <sub>1</sub>	G <sub>2</sub>	C <sub>g</sub>	
			Max Shaft Fillet Radius R <sup>(5)</sup>	Backing Shoulder Dia. d <sub>a</sub> d <sub>b</sub>		Max Housing Fillet Radius r <sup>(5)</sup>	Backing Shoulder Dia. D <sub>a</sub> D <sub>b</sub>		A <sub>a</sub> <sup>(6)</sup>	A <sub>b</sub> <sup>(7)</sup>				
mm in.	mm in.	mm in.	mm in.	mm in.	mm in.	mm in.	mm in.	mm in.	mm in.	mm in.				kg lbs.
52.388 2.0625	39.688 1.5625	6.9 0.27	3.5 0.14	131.2 5.16	139.0 5.47	3.3 0.13	205.0 8.07	186.0 7.32	6.6 0.26	3.4 0.14	245.6	32.2	0.1299	8.40 18.53
34.925 1.3750	26.988 1.0625	-1.5 -0.06	3.5 0.14	118.0 4.65	124.0 4.88	3.3 0.13	154.0 6.06	146.0 5.75	2.4 0.09	1.4 0.06	231.6	63.4	0.1576	2.24 4.94
34.925 1.3750	26.988 1.0625	-1.5 -0.06	8.0 0.31	118.0 4.65	133.0 5.24	3.3 0.13	154.0 6.06	146.0 5.75	2.4 0.09	1.4 0.06	231.6	63.4	0.1576	2.17 4.78
41.275 1.6250	30.162 1.1875	1.3 0.05	3.5 0.14	121.0 4.76	128.0 5.04	3.3 0.13	172.0 6.77	160.0 6.30	5.2 0.20	2.1 0.08	218.8	45.3	0.1153	3.71 8.19
35.000 1.3780	26.500 1.0433	3.0 0.12	3.0 0.12	119.0 4.69	125.0 4.92	2.5 0.10	159.0 6.26	149.0 5.87	2.9 0.11	2.0 0.08	191.5	45.8	0.1585	2.44 5.39
46.000 1.8110	38.000 1.4961	-5.8 -0.23	7.0 0.28	122.0 4.80	138.0 5.43	2.5 0.10	172.0 6.77	162.0 6.38	2.6 0.10	3.9 0.16	259.2	52.1	0.1134	N/A* N/A*
66.675 2.6250	53.975 2.1250	-19.8 -0.78	6.4 0.25	124.0 4.88	136.0 5.35	3.3 0.13	193.1 7.60	187.0 7.36	6.6 0.26	1.3 0.05	338.6	39.8	0.1153	10.26 22.63
30.162 1.1875	25.268 0.9948	4.6 0.18	3.5 0.14	118.0 4.65	124.0 4.88	3.3 0.13	164.0 6.46	156.0 6.14	3.4 0.13	2.1 0.09	151.5	50.5	0.0987	2.44 5.37
30.162 1.1875	25.268 0.9948	4.6 0.18	3.5 0.14	119.0 4.69	125.0 4.92	3.3 0.13	164.0 6.46	156.0 6.14	3.4 0.13	2.1 0.09	151.5	50.5	0.0987	2.41 5.29
49.212 1.9375	34.925 1.3750	-6.6 -0.26	3.6 0.14	123.0 4.84	129.0 5.08	3.3 0.13	181.0 7.13	171.0 6.73	5.3 0.21	1.5 0.06	269.2	49.5	0.1156	5.37 11.85
52.388 2.0625	39.688 1.5625	6.9 0.27	3.5 0.14	131.2 5.16	139.0 5.47	3.3 0.13	205.0 8.07	186.0 7.32	6.6 0.26	3.4 0.14	245.6	32.2	0.1299	8.32 18.35
21.433 0.8438	16.670 0.6563	6.4 0.25	1.5 0.06	120.0 4.72	123.0 4.84	1.5 0.06	147.0 5.79	143.0 5.63	1.0 0.04	1.6 0.07	171.2	122.8	0.1422	1.05 2.31
41.275 1.6250	30.162 1.1875	1.3 0.05	3.5 0.14	125.0 4.92	131.0 5.16	3.3 0.13	172.0 6.77	160.0 6.30	5.2 0.20	2.1 0.08	218.8	45.3	0.1153	3.46 7.64
41.275 1.6250	30.162 1.1875	1.3 0.05	3.5 0.14	125.0 4.92	131.0 5.16	3.0 0.12	172.0 6.77	160.0 6.30	5.2 0.20	2.1 0.08	218.8	45.3	0.1153	3.48 7.68
41.275 1.6250	30.162 1.1875	1.3 0.05	3.5 0.14	125.0 4.92	131.0 5.16	3.3 0.13	173.0 6.81	161.0 6.34	5.2 0.20	2.1 0.08	218.8	45.3	0.1153	3.61 7.96
41.275 1.6250	30.162 1.1875	1.3 0.05	3.5 0.14	125.0 4.92	131.0 5.16	3.3 0.13	173.0 6.81	161.0 6.34	5.2 0.20	2.1 0.08	218.8	45.3	0.1153	3.67 8.11
49.212 1.9375	34.925 1.3750	-6.6 -0.26	3.6 0.14	125.0 4.92	132.0 5.20	3.3 0.13	181.0 7.13	171.0 6.73	5.3 0.21	1.6 0.06	269.2	49.5	0.1156	5.16 11.38

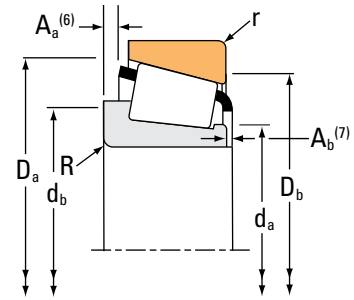
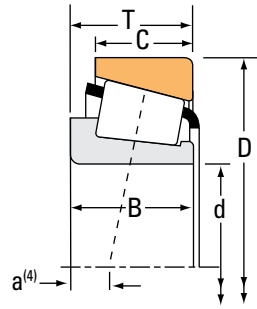
(4) Negative value indicates effective center inside cone (inner-ring) backface.  
 (5) These maximum fillet radii will be cleared by the bearing corners.  
 (6) Negative value indicates cage extends beyond cone (inner-ring) backface.  
 (7) Negative value indicates cage that does not extend beyond cone (inner-ring) front face.  
 (\*) Contact your Timken engineer for details.

Continued on next page.

# TAPERED ROLLER BEARINGS

## SINGLE-ROW • TYPE TS

### TYPE TS



Bearing Dimensions			Load Ratings							Part Number			
Bore d	O.D. D	Width T	Dynamic <sup>(1)</sup>		Factors <sup>(2)</sup>		Dynamic <sup>(3)</sup>		Factors <sup>(2)</sup>		Static C <sub>0</sub>	Inner	Outer
			C <sub>1</sub>	e	Y	C <sub>90</sub>	C <sub>a90</sub>	K	N	N			
mm in.	mm in.	mm in.	N lbf			N lbf	N lbf		N lbf				
114.300 4.5000	206.375 8.1250	66.675 2.6250	572000 129000	0.33	1.84	148000 33300	82700 18600	1.79	786000 177000			938	930
114.300 4.5000	212.725 8.3750	66.675 2.6250	680000 153000	0.33	1.84	176000 39600	98300 22100	1.79	906000 204000			HH224346	HH224310
114.300 4.5000	212.725 8.3750	66.675 2.6250	572000 129000	0.33	1.84	148000 33300	82700 18600	1.79	786000 177000			938	932
114.300 4.5000	214.975 8.4636	64.798 2.5511	680000 153000	0.33	1.84	176000 39600	98300 22100	1.79	906000 204000			HH224346	HH224314
114.300 4.5000	228.600 9.0000	53.975 2.1250	586000 132000	0.74	0.81	152000 34200	192000 43100	0.79	673000 151000			HM926740	HM926710
114.300 4.5000	273.050 10.7500	82.550 3.2500	1070000 240000	0.63	0.95	276000 62100	299000 67200	0.92	1080000 243000			HH926744	HH926710
114.300 4.5000	279.400 11.0000	82.550 3.2500	1070000 240000	0.63	0.95	276000 62100	299000 67200	0.92	1080000 243000			HH926744	HH926716
114.975 4.5266	177.800 7.0000	41.275 1.6250	275000 61800	0.52	1.16	71200 16000	62900 14100	1.13	419000 94200			64452A	64700
114.975 4.5266	180.975 7.1250	41.275 1.6250	275000 61800	0.52	1.16	71200 16000	62900 14100	1.13	419000 94200			64452A	64713
114.975 4.5266	212.725 8.3750	66.675 2.6250	680000 153000	0.33	1.84	176000 39600	98300 22100	1.79	906000 204000			HH224349	HH224310
115.000 4.5276	165.000 6.4961	28.000 1.1024	160000 35900	0.46	1.31	41400 9310	32500 7310	1.27	245000 55100			JLM722948	JLM722912
115.087 4.5310	190.500 7.5000	47.625 1.8750	364000 81700	0.42	1.44	94300 21200	67100 15100	1.40	543000 122000			71455	71750
115.087 4.5310	190.500 7.5000	47.625 1.8750	364000 81700	0.42	1.44	94300 21200	67100 15100	1.40	543000 122000			71453	71750
117.475 4.6250	179.975 7.0856	34.925 1.3750	232000 52100	0.50	1.21	60100 13500	51100 11500	1.18	271000 61000			68462	68709
117.475 4.6250	180.975 7.1250	34.925 1.3750	232000 52100	0.50	1.21	60100 13500	51100 11500	1.18	271000 61000			68462	68712
117.475 4.6250	180.975 7.1250	34.925 1.3750	232000 52100	0.50	1.21	60100 13500	51100 11500	1.18	271000 61000			68463	68712
119.964 4.7230	215.900 8.5000	47.625 1.8750	382000 85900	0.49	1.23	99000 22300	82600 18600	1.20	614000 138000			74472	74850

<sup>(1)</sup>Based on 1 x 10<sup>6</sup> revolutions L<sub>10</sub> life, for the ISO life-calculation method.

<sup>(2)</sup>Consult your Timken engineer for instructions on use or review the Timken Engineering Manual on timken.com/catalogs.

<sup>(3)</sup>Based on 90 x 10<sup>6</sup> revolutions L<sub>10</sub> life, for The Timken Company life-calculation method. C<sub>90</sub> and C<sub>a90</sub> are radial and thrust values.

Bearing Dimensions											Geometry Factors			Bearing Weight
Width B	Width C	Eff. Ctr. a <sup>(4)</sup>	Shaft			Housing			Cage		G <sub>1</sub>	G <sub>2</sub>	C <sub>g</sub>	
			Max Shaft Fillet Radius R <sup>(5)</sup>	Backing Shoulder Dia. d <sub>a</sub>	Backing Shoulder Dia. d <sub>b</sub>	Max Housing Fillet Radius r <sup>(5)</sup>	Backing Shoulder Dia. D <sub>a</sub>	Backing Shoulder Dia. D <sub>b</sub>	A <sub>a</sub> <sup>(6)</sup>	A <sub>b</sub> <sup>(7)</sup>				
mm in.	mm in.	mm in.	mm in.	mm in.	mm in.	mm in.	mm in.	mm in.	mm in.	mm in.			kg lbs.	
66.675 2.6250	53.975 2.1250	-19.8 -0.78	7.0 0.28	128.0 5.04	141.0 5.55	3.3 0.13	193.1 7.60	184.0 7.24	6.6 0.26	1.3 0.05	338.6	39.8	0.1153	8.98 19.79
66.675 2.6250	53.975 2.1250	-18.8 -0.74	7.0 0.28	131.0 5.16	143.0 5.63	3.3 0.13	201.7 7.94	192.0 7.56	4.8 0.19	2.9 0.12	366.6	47.9	0.1182	9.92 21.85
66.675 2.6250	53.975 2.1250	-19.8 -0.78	7.0 0.28	128.0 5.04	141.0 5.55	3.3 0.13	193.1 7.60	187.0 7.36	6.6 0.26	1.3 0.05	338.6	39.8	0.1153	9.83 21.67
66.675 2.6250	50.800 2.0000	-18.8 -0.74	7.0 0.28	131.0 5.16	143.0 5.63	3.3 0.13	201.2 7.92	192.0 7.56	4.8 0.19	2.9 0.12	366.6	47.9	0.1182	10.03 22.10
49.428 1.9460	38.100 1.5000	13.5 0.53	3.5 0.14	142.0 5.59	146.0 5.75	3.3 0.13	219.3 8.63	200.0 7.87	9.0 0.35	6.4 0.26	295.4	39.0	0.1416	9.54 21.04
82.550 3.2500	53.975 2.1250	-6.6 -0.26	6.4 0.25	147.2 5.80	164.0 6.46	6.4 0.25	253.3 9.97	230.0 9.06	15.1 0.59	4.1 0.17	384.1	37.8	0.1472	22.09 48.68
82.550 3.2500	53.975 2.1250	-6.6 -0.26	6.4 0.25	147.2 5.80	164.0 6.46	6.4 0.25	253.3 9.97	233.0 9.17	15.1 0.59	4.1 0.17	384.1	37.8	0.1472	23.16 51.05
41.275 1.6250	30.162 1.1875	1.3 0.05	9.0 0.35	125.9 4.96	143.0 5.63	3.3 0.13	172.0 6.77	160.0 6.30	5.2 0.20	2.1 0.08	218.8	45.3	0.1153	3.32 7.34
41.275 1.6250	30.162 1.1875	1.3 0.05	9.0 0.35	125.9 4.96	143.0 5.63	3.3 0.13	173.0 6.81	161.0 6.34	5.2 0.20	2.1 0.08	218.8	45.3	0.1153	3.53 7.80
66.675 2.6250	53.975 2.1250	-18.8 -0.74	7.0 0.28	131.0 5.16	144.0 5.67	3.3 0.13	201.7 7.94	192.0 7.56	4.8 0.19	2.9 0.12	366.6	47.9	0.1182	9.85 21.71
27.000 1.0630	21.000 0.8268	5.6 0.22	3.3 0.13	121.0 4.76	127.0 5.00	3.0 0.12	158.0 6.22	151.0 5.94	2.2 0.08	2.4 0.10	161.0	57.2	0.1449	1.75 3.86
49.212 1.9375	34.925 1.3750	-6.6 -0.26	8.0 0.31	126.0 4.96	141.0 5.55	3.3 0.13	181.0 7.13	171.0 6.73	5.3 0.21	1.5 0.06	269.2	49.5	0.1156	5.02 11.07
49.212 1.9375	34.925 1.3750	-6.6 -0.26	3.5 0.14	126.0 4.96	133.0 5.24	3.3 0.13	181.0 7.13	171.0 6.73	5.3 0.21	1.5 0.06	269.2	49.5	0.1156	5.09 11.23
31.750 1.2500	25.400 1.0000	5.3 0.21	3.5 0.14	125.0 4.92	132.0 5.20	0.8 0.03	172.0 6.77	165.0 6.50	5.1 0.20	2.3 0.09	163.1	51.7	0.1026	2.71 5.98
31.750 1.2500	25.400 1.0000	5.3 0.21	3.5 0.14	125.0 4.92	132.0 5.20	3.3 0.13	172.0 6.77	163.0 6.42	5.1 0.20	2.3 0.09	163.1	51.7	0.1026	2.74 6.06
31.750 1.2500	25.400 1.0000	5.3 0.21	8.0 0.31	125.0 4.92	140.0 5.51	3.3 0.13	172.0 6.77	163.0 6.42	5.1 0.20	2.3 0.09	163.1	51.7	0.1026	2.67 5.89
47.625 1.8750	34.925 1.3750	2.3 0.09	3.5 0.14	136.0 5.35	142.0 5.59	3.3 0.13	208.0 8.19	196.0 7.72	4.8 0.18	2.0 0.08	362.9	68.5	0.1338	7.47 16.47

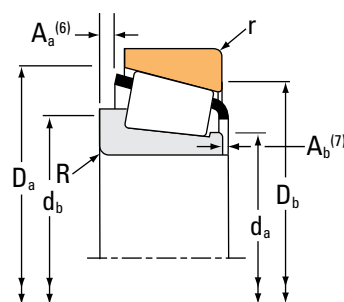
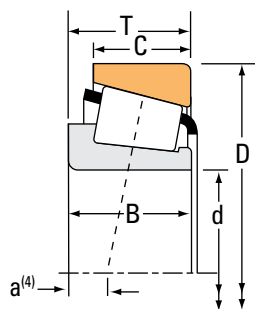
(4) Negative value indicates effective center inside cone (inner-ring) backface.  
 (5) These maximum fillet radii will be cleared by the bearing corners.  
 (6) Negative value indicates cage extends beyond cone (inner-ring) backface.  
 (7) Negative value indicates cage that does not extend beyond cone (inner-ring) front face.

Continued on next page.

# TAPERED ROLLER BEARINGS

SINGLE-ROW • TYPE TS

## TYPE TS



Bearing Dimensions			Load Ratings							Part Number		
Bore d	O.D. D	Width T	Dynamic <sup>(1)</sup>		Factors <sup>(2)</sup>		Dynamic <sup>(3)</sup>		Factors <sup>(2)</sup>	Static	Inner	Outer
			C <sub>1</sub>	e	Y	C <sub>90</sub>	C <sub>a90</sub>	K	C <sub>0</sub>			
mm in.	mm in.	mm in.	N lbf			N lbf	N lbf			N lbf		
119.974 4.7234	174.625 6.8750	35.720 1.4063	244000 54900	0.33	1.80	63400 14200	36100 8110	1.76		422000 94900	M224748	M224710
120.000 4.7244	170.000 6.6929	25.400 1.0000	145000 32600	0.46	1.31	37600 8450	29500 6640	1.27		231000 52000	JL724348	JL724314
120.000 4.7244	170.000 6.6929	27.000 1.0630	165000 37200	0.47	1.27	42900 9640	34700 7800	1.24		238000 53500	JP12049	JP12010
120.000 4.7244	170.000 6.6929	27.000 1.0630	165000 37200	0.47	1.27	42900 9640	34700 7800	1.24		238000 53500	JP12049A	JP12010
120.000 4.7244	180.000 7.0866	36.000 1.4173	247000 55500	0.41	1.45	64000 14400	45300 10200	1.41		377000 84700	JM624649	JM624610
120.000 4.7244	215.900 8.5000	47.625 1.8750	382000 85900	0.49	1.23	99000 22300	82600 18600	1.20		614000 138000	74473X	74850
120.000 4.7244	230.000 9.0551	53.975 2.1250	376000 84500	0.74	0.81	97500 21900	123000 27600	0.79		486000 109000	97472X	97905X
120.650 4.7500	161.925 6.3750	21.433 0.8438	97500 21900	0.43	1.38	25300 5680	18800 4230	1.34		206000 46400	L624549	L624514
120.650 4.7500	166.688 6.5625	25.400 1.0000	145000 32600	0.46	1.31	37600 8450	29500 6640	1.27		231000 52000	L724349	L724310
120.650 4.7500	169.862 6.6875	25.400 1.0000	143000 32100	0.33	1.80	37000 8320	21100 4740	1.76		273000 61400	L225842	L225810
120.650 4.7500	172.242 6.7812	35.720 1.4063	244000 54900	0.33	1.80	63400 14200	36100 8110	1.76		422000 94900	M224749	M224711
120.650 4.7500	174.625 6.8750	35.720 1.4063	244000 54900	0.33	1.80	63400 14200	36100 8110	1.76		422000 94900	M224749	M224710
120.650 4.7500	174.625 6.8750	35.720 1.4063	244000 54900	0.33	1.80	63400 14200	36100 8110	1.76		422000 94900	M224749	M224712
120.650 4.7500	180.975 7.1250	25.400 1.0000	143000 32100	0.33	1.80	37000 8320	21100 4740	1.76		273000 61400	L225842	L225818
120.650 4.7500	182.562 7.1875	39.688 1.5625	268000 60200	0.31	1.97	69400 15600	36300 8160	1.91		493000 111000	48282	48220
120.650 4.7500	190.500 7.5000	46.038 1.8125	362000 81300	0.43	1.41	93700 21100	68500 15400	1.37		543000 122000	HM624749	HM624710
120.650 4.7500	199.975 7.8730	46.038 1.8125	362000 81300	0.43	1.41	93700 21100	68500 15400	1.37		543000 122000	HM624749	HM624716

<sup>(1)</sup>Based on 1 x 10<sup>6</sup> revolutions L<sub>10</sub> life, for the ISO life-calculation method.

<sup>(2)</sup>Consult your Timken engineer for instructions on use or review the Timken Engineering Manual on timken.com/catalogs.

<sup>(3)</sup>Based on 90 x 10<sup>6</sup> revolutions L<sub>10</sub> life, for The Timken Company life-calculation method. C<sub>90</sub> and C<sub>a90</sub> are radial and thrust values.



Bearing Dimensions											Geometry Factors			Bearing Weight
Width B	Width C	Eff. Ctr. a <sup>(4)</sup>	Shaft			Housing			Cage		G <sub>1</sub>	G <sub>2</sub>	C <sub>g</sub>	
			Max Shaft Fillet Radius R <sup>(5)</sup>	Backing Shoulder Dia. d <sub>a</sub>	Backing Shoulder Dia. d <sub>b</sub>	Max Housing Fillet Radius r <sup>(5)</sup>	Backing Shoulder Dia. D <sub>a</sub>	Backing Shoulder Dia. D <sub>b</sub>	A <sub>a</sub> <sup>(6)</sup>	A <sub>b</sub> <sup>(7)</sup>				
mm in.	mm in.	mm in.	mm in.	mm in.	mm in.	mm in.	mm in.	mm in.	mm in.	mm in.				kg lbs.
36.512 1.4375	27.783 1.0938	-3.6 -0.14	3.5 0.14	129.0 5.08	134.0 5.28	1.5 0.06	167.9 6.61	162.0 6.38	3.7 0.14	0.5 0.02	279.1	86.6	0.1575	2.71 5.98
25.400 1.0000	19.050 0.7500	7.9 0.31	3.3 0.13	127.0 5.00	132.0 5.20	3.3 0.13	163.0 6.42	156.0 6.14	2.7 0.10	1.2 0.05	170.2	70.6	0.1472	1.62 3.56
25.000 0.9843	19.500 0.7677	7.9 0.31	3.0 0.12	127.0 5.00	133.0 5.24	3.0 0.12	164.5 6.48	157.0 6.18	2.8 0.11	3.7 0.15	157.8	76.7	0.1451	1.70 3.76
25.000 0.9843	19.500 0.7677	7.9 0.31	6.0 0.24	127.0 5.00	139.0 5.47	3.0 0.12	164.5 6.48	157.0 6.18	2.8 0.11	3.7 0.15	157.8	76.7	*	1.69 3.72
36.000 1.4173	26.000 1.0236	0.0 0.00	3.5 0.14	128.0 5.04	135.0 5.31	1.5 0.06	173.0 6.81	166.0 6.54	3.5 0.14	2.7 0.11	226.8	61.6	0.1084	2.92 6.46
47.625 1.8750	34.925 1.3750	2.3 0.09	4.0 0.16	137.0 5.39	144.0 5.67	3.3 0.13	208.0 8.19	196.0 7.72	4.8 0.18	2.0 0.08	362.9	68.5	0.1338	7.46 16.45
49.428 1.9460	38.100 1.5000	13.2 0.52	3.5 0.14	140.0 5.51	145.0 5.71	3.3 0.13	213.0 8.38	198.0 7.80	8.2 0.32	4.8 0.19	237.1	44.6	0.1311	8.92 19.66
21.433 0.8438	16.670 0.6563	8.4 0.33	1.5 0.06	127.0 5.00	129.0 5.08	1.5 0.06	156.0 6.14	151.0 5.94	1.1 0.04	1.7 0.07	195.2	139.1	0.1509	1.21 2.67
25.400 1.0000	19.050 0.7500	7.9 0.31	3.3 0.13	128.0 5.04	133.0 5.24	3.3 0.13	161.0 6.34	154.0 6.06	2.7 0.10	1.2 0.05	170.2	70.6	0.1472	1.49 3.27
26.195 1.0313	20.638 0.8125	2.5 0.10	1.5 0.06	129.0 5.08	131.0 5.16	1.5 0.06	164.0 6.46	160.0 6.30	0.7 0.02	1.6 0.07	253.2	134.6	0.1511	1.84 4.05
36.512 1.4375	27.783 1.0938	-3.6 -0.14	3.5 0.14	129.0 5.08	135.0 5.31	1.5 0.06	166.9 6.57	162.0 6.38	3.7 0.14	0.5 0.02	279.1	86.6	0.1575	2.53 5.59
36.512 1.4375	27.783 1.0938	-3.6 -0.14	3.5 0.14	129.0 5.08	135.0 5.31	1.5 0.06	167.9 6.61	162.0 6.38	3.7 0.14	0.5 0.02	279.1	86.6	0.1575	2.67 5.90
36.512 1.4375	27.783 1.0938	-3.6 -0.14	3.5 0.14	129.0 5.08	135.0 5.31	3.3 0.13	167.9 6.61	161.0 6.34	3.7 0.14	0.5 0.02	279.1	86.6	0.1575	2.67 5.90
26.195 1.0313	20.638 0.8125	2.5 0.10	1.5 0.06	129.0 5.08	131.0 5.16	1.5 0.06	166.0 6.54	164.0 6.46	0.7 0.02	1.6 0.07	253.2	134.6	0.1511	2.33 5.13
38.100 1.5000	33.338 1.3125	-5.6 -0.22	3.5 0.14	131.0 5.16	137.0 5.39	3.3 0.13	176.0 6.93	168.0 6.61	1.8 0.07	3.3 0.13	353.0	91.4	0.1138	3.62 7.99
46.038 1.8125	34.925 1.3750	-3.8 -0.15	3.5 0.14	132.0 5.20	138.0 5.43	1.5 0.06	184.0 7.24	174.0 6.85	3.7 0.14	2.6 0.11	278.8	51.5	0.1178	4.61 10.16
46.038 1.8125	34.925 1.3750	-3.8 -0.15	3.5 0.14	132.0 5.20	138.0 5.43	1.5 0.06	185.0 7.28	178.0 7.01	3.7 0.14	2.6 0.11	278.8	51.5	0.1178	5.40 11.90

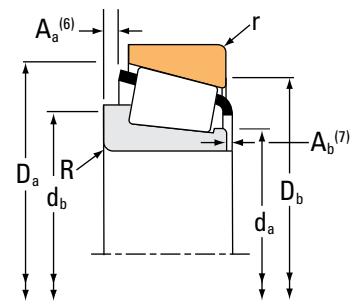
(4) Negative value indicates effective center inside cone (inner-ring) backface.  
 (5) These maximum fillet radii will be cleared by the bearing corners.  
 (6) Negative value indicates cage extends beyond cone (inner-ring) backface.  
 (7) Negative value indicates cage that does not extend beyond cone (inner-ring) front face.  
 (\*) Contact your Timken engineer for details.

Continued on next page.

# TAPERED ROLLER BEARINGS

## SINGLE-ROW • TYPE TS

### TYPE TS



Bearing Dimensions			Load Ratings							Part Number		
Bore d	O.D. D	Width T	Dynamic <sup>(1)</sup>		Factors <sup>(2)</sup>		Dynamic <sup>(3)</sup>		Factors <sup>(2)</sup>	Static	Inner	Outer
			C <sub>1</sub>	e	Y	C <sub>90</sub>	C <sub>a90</sub>	K	C <sub>0</sub>			
mm in.	mm in.	mm in.	N lbf			N lbf	N lbf		N lbf			
120.650 4.7500	206.375 8.1250	47.625 1.8750	378000 85000	0.46	1.31	98000 22000	77000 17300	1.27	593000 133000		795	792
120.650 4.7500	234.950 9.2500	63.500 2.5000	629000 141000	0.37	1.62	163000 36700	103000 23200	1.58	931000 209000		95475	95925
120.650 4.7500	254.000 10.0000	77.788 3.0625	910000 205000	0.32	1.87	236000 53000	130000 29200	1.82	1240000 279000		HH228340	HH228310
120.650 4.7500	259.975 10.2352	77.788 3.0625	910000 205000	0.32	1.87	236000 53000	130000 29200	1.82	1240000 279000		HH228340	HH228318
120.650 4.7500	273.050 10.7500	82.550 3.2500	1070000 240000	0.63	0.95	276000 62100	299000 67200	0.92	1080000 243000		HH926749	HH926710
123.825 4.8750	182.562 7.1875	39.688 1.5625	268000 60200	0.31	1.97	69400 15600	36300 8160	1.91	493000 111000		48286	48220
124.943 4.9190	234.950 9.2500	63.500 2.5000	629000 141000	0.37	1.62	163000 36700	103000 23200	1.58	931000 209000		95491	95925
125.000 4.9213	175.000 6.8898	25.400 1.0000	150000 33700	0.48	1.26	38900 8750	31700 7130	1.23	246000 55300		JL725346	JL725316
125.298 4.9330	228.600 9.0000	53.975 2.1250	586000 132000	0.74	0.81	152000 34200	192000 43100	0.79	673000 151000		HM926745	HM926710
127.000 5.0000	165.895 6.5313	18.258 0.7188	90200 20300	0.33	1.80	23400 5260	13300 2990	1.76	153000 34400		LL225749	LL225710
127.000 5.0000	169.862 6.6875	25.400 1.0000	143000 32100	0.33	1.80	37000 8320	21100 4740	1.76	273000 61400		L225849	L225810
127.000 5.0000	171.450 6.7500	25.400 1.0000	150000 33700	0.48	1.26	38900 8750	31700 7130	1.23	246000 55300		L725349	L725311
127.000 5.0000	174.625 6.8750	36.512 1.4375	220000 49500	0.31	1.95	57100 12800	30000 6750	1.90	413000 92900		LM125748	LM125711
127.000 5.0000	180.975 7.1250	25.400 1.0000	143000 32100	0.33	1.80	37000 8320	21100 4740	1.76	273000 61400		L225849	L225818
127.000 5.0000	182.562 7.1875	39.688 1.5625	268000 60200	0.31	1.97	69400 15600	36300 8160	1.91	493000 111000		48290	48220
127.000 5.0000	196.850 7.7500	46.038 1.8125	368000 82600	0.34	1.74	95300 21400	56100 12600	1.70	625000 141000		67388	67322
127.000 5.0000	203.200 8.0000	46.038 1.8125	368000 82600	0.34	1.74	95300 21400	56100 12600	1.70	625000 141000		67388	67320

<sup>(1)</sup>Based on 1 x 10<sup>6</sup> revolutions L<sub>10</sub> life, for the ISO life-calculation method.

<sup>(2)</sup>Consult your Timken engineer for instructions on use or review the Timken Engineering Manual on timken.com/catalogs.

<sup>(3)</sup>Based on 90 x 10<sup>6</sup> revolutions L<sub>10</sub> life, for The Timken Company life-calculation method. C<sub>90</sub> and C<sub>a90</sub> are radial and thrust values.

Bearing Dimensions											Geometry Factors			Bearing Weight
Width B	Width C	Eff. Ctr. a <sup>(4)</sup>	Shaft			Housing			Cage		G <sub>1</sub>	G <sub>2</sub>	C <sub>g</sub>	
			Max Shaft Fillet Radius R <sup>(5)</sup>	Backing Shoulder Dia. d <sub>a</sub>	Backing Shoulder Dia. d <sub>b</sub>	Max Housing Fillet Radius r <sup>(5)</sup>	Backing Shoulder Dia. D <sub>a</sub>	Backing Shoulder Dia. D <sub>b</sub>	A <sub>a</sub> <sup>(6)</sup>	A <sub>b</sub> <sup>(7)</sup>				
mm in.	mm in.	mm in.	mm in.	mm in.	mm in.	mm in.	mm in.	mm in.	mm in.	mm in.				kg lbs.
47.625 1.8750	34.925 1.3750	-1.8 -0.07	3.3 0.13	134.0 5.28	139.0 5.47	3.3 0.13	196.0 7.72	186.0 7.32	5.3 0.21	2.8 0.11	326.4	62.0	0.1269	6.34 13.99
63.500 2.5000	49.212 1.9375	-14.0 -0.55	6.4 0.25	137.0 5.39	149.0 5.87	3.3 0.13	217.0 8.54	209.0 8.23	6.4 0.25	3.8 0.15	453.9	59.4	0.1323	12.35 27.25
82.550 3.2500	61.912 2.4375	-23.4 -0.92	9.7 0.38	142.0 5.59	158.0 6.22	6.4 0.25	233.6 9.20	223.0 8.78	7.0 0.27	0.0 0.00	529.8	44.8	0.1329	18.57 40.95
82.550 3.2500	61.912 2.4375	-23.4 -0.92	9.7 0.38	142.0 5.59	158.0 6.22	4.0 0.16	233.6 9.20	228.0 8.98	7.0 0.27	0.0 0.00	529.8	44.8	0.1329	19.85 43.77
82.550 3.2500	53.975 2.1250	-6.6 -0.26	6.4 0.25	147.2 5.80	168.0 6.61	6.4 0.25	253.3 9.97	230.0 9.06	15.1 0.59	4.1 0.17	384.1	37.8	0.1472	21.33 47.01
38.100 1.5000	33.338 1.3125	-5.6 -0.22	3.5 0.14	133.0 5.24	139.0 5.47	3.3 0.13	176.0 6.93	168.0 6.61	1.8 0.07	3.3 0.13	353.0	91.4	0.1138	3.44 7.58
63.500 2.5000	49.212 1.9375	-14.0 -0.55	6.4 0.25	140.0 5.51	152.0 5.98	3.3 0.13	217.0 8.54	209.0 8.23	6.4 0.25	3.8 0.15	453.9	59.4	0.1323	11.94 26.34
25.400 1.0000	18.288 0.7200	9.1 0.36	3.3 0.13	133.0 5.24	138.0 5.43	3.3 0.13	168.0 6.61	161.0 6.34	3.0 0.11	1.5 0.06	186.6	77.7	0.1535	1.69 3.72
49.428 1.9460	38.100 1.5000	13.5 0.53	3.5 0.14	143.0 5.63	154.0 6.06	3.3 0.13	219.3 8.63	200.0 7.87	9.0 0.35	6.4 0.26	295.4	39.0	0.1416	8.74 19.26
17.462 0.6875	13.495 0.5313	6.1 0.24	1.5 0.06	133.0 5.24	135.0 5.31	1.5 0.06	160.0 6.30	158.0 6.22	1.3 0.05	2.1 0.09	163.9	140.7	0.1297	0.92 2.02
26.195 1.0313	20.638 0.8125	2.5 0.10	1.5 0.06	134.0 5.28	136.0 5.35	1.5 0.06	164.0 6.46	160.0 6.30	0.7 0.02	1.6 0.07	253.2	134.6	0.1511	1.58 3.49
25.400 1.0000	18.288 0.7200	9.1 0.36	3.3 0.13	134.0 5.28	139.0 5.47	3.3 0.13	167.0 6.57	160.0 6.30	3.0 0.11	1.5 0.06	186.6	77.7	0.1535	1.50 3.30
36.512 1.4375	31.750 1.2500	-4.3 -0.17	3.3 0.13	134.9 5.31	139.9 5.51	3.3 0.13	167.9 6.61	161.0 6.34	2.2 0.08	0.6 0.03	314.8	110.2	0.1594	2.54 5.60
26.195 1.0313	20.638 0.8125	2.5 0.10	1.5 0.06	134.0 5.28	136.0 5.35	1.5 0.06	166.0 6.54	164.0 6.46	0.7 0.02	1.6 0.07	253.2	134.6	0.1511	2.07 4.57
38.100 1.5000	33.338 1.3125	-5.6 -0.22	3.5 0.14	135.0 5.31	141.0 5.55	3.3 0.13	176.0 6.93	168.0 6.61	1.8 0.07	3.3 0.13	353.0	91.4	0.1138	3.26 7.17
46.038 1.8125	38.100 1.5000	-6.4 -0.25	3.5 0.14	138.0 5.43	144.0 5.67	3.3 0.13	189.0 7.44	180.0 7.09	4.2 0.16	1.4 0.06	383.7	70.1	0.1220	5.05 11.13
46.038 1.8125	38.100 1.5000	-6.4 -0.25	3.5 0.14	138.0 5.43	144.0 5.67	3.3 0.13	191.0 7.52	183.0 7.20	4.2 0.16	1.4 0.06	383.7	70.1	0.1220	5.65 12.45

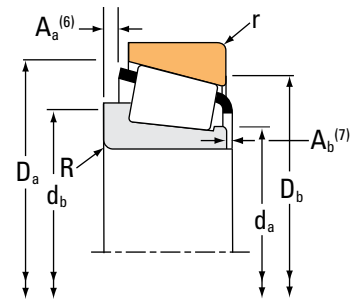
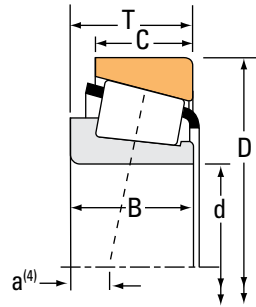
<sup>(4)</sup>Negative value indicates effective center inside cone (inner-ring) backface.  
<sup>(5)</sup>These maximum fillet radii will be cleared by the bearing corners.  
<sup>(6)</sup>Negative value indicates cage extends beyond cone (inner-ring) backface.  
<sup>(7)</sup>Negative value indicates cage that does not extend beyond cone (inner-ring) front face.

Continued on next page.

# TAPERED ROLLER BEARINGS

## SINGLE-ROW • TYPE TS

### TYPE TS



Bearing Dimensions			Load Ratings							Part Number		
Bore d	O.D. D	Width T	Dynamic <sup>(1)</sup>		Factors <sup>(2)</sup>		Dynamic <sup>(3)</sup>		Factors <sup>(2)</sup>	Static	Inner	Outer
			C <sub>1</sub>	e	Y	C <sub>90</sub>	C <sub>a90</sub>	K	C <sub>0</sub>			
mm in.	mm in.	mm in.	N lbf			N lbf	N lbf		N lbf			
127.000 5.0000	215.900 8.5000	47.625 1.8750	382000 85900	0.49	1.23	99000 22300	82600 18600	1.20	614000 138000		74500	74850
127.000 5.0000	228.600 9.0000	53.975 2.1250	446000 100000	0.74	0.81	116000 26000	146000 32700	0.79	486000 109000		97500	97900
127.000 5.0000	228.600 9.0000	53.975 2.1250	586000 132000	0.74	0.81	152000 34200	192000 43100	0.79	673000 151000		HM926747	HM926710
127.000 5.0000	234.950 9.2500	63.500 2.5000	629000 141000	0.37	1.62	163000 36700	103000 23200	1.58	931000 209000		95500	95925
127.000 5.0000	244.475 9.6250	63.500 2.5000	629000 141000	0.37	1.62	163000 36700	103000 23200	1.58	931000 209000		95500	95962
127.000 5.0000	250.825 9.8750	63.500 2.5000	602000 135000	0.37	1.63	156000 35100	98100 22100	1.59	867000 195000		EE116050	116098
127.000 5.0000	254.000 10.0000	66.675 2.6250	660000 148000	0.41	1.47	171000 38500	119000 26800	1.43	1030000 231000		99500	99100
127.000 5.0000	254.000 10.0000	77.788 3.0625	910000 205000	0.32	1.87	236000 53000	130000 29200	1.82	1240000 279000		HH228349	HH228310
127.000 5.0000	288.925 11.3750	82.550 3.2500	1140000 257000	0.32	1.88	296000 66600	162000 36300	1.83	1340000 302000		HH231637	HH231610
127.000 5.0000	295.275 11.6250	82.550 3.2500	1140000 257000	0.32	1.88	296000 66600	162000 36300	1.83	1340000 302000		HH231637	HH231615
127.000 5.0000	304.800 12.0000	88.900 3.5000	1160000 260000	0.73	0.82	300000 67500	374000 84100	0.80	1250000 282000		HH932132	HH932110
127.000 5.0000	311.150 12.2500	88.900 3.5000	1160000 260000	0.73	0.82	300000 67500	374000 84100	0.80	1250000 282000		HH932132	HH932115
127.792 5.0312	228.600 9.0000	53.975 2.1250	586000 132000	0.74	0.81	152000 34200	192000 43100	0.79	673000 151000		HM926749	HM926710
128.588 5.0625	190.500 7.5000	34.925 1.3750	177000 39800	0.65	0.92	45900 10300	51300 11500	0.89	300000 67400		48506	48750
128.588 5.0625	206.375 8.1250	47.625 1.8750	378000 85000	0.46	1.31	98000 22000	77000 17300	1.27	593000 133000		799	792
129.975 5.1171	234.975 9.2510	64.798 2.5511	629000 141000	0.37	1.62	163000 36700	103000 23200	1.58	931000 209000		95512	95929
130.000 5.1181	185.000 7.2835	29.000 1.1417	196000 44000	0.47	1.27	50800 11400	41100 9250	1.24	283000 63600		JP13049A	JP13010

<sup>(1)</sup>Based on  $1 \times 10^6$  revolutions  $L_{10}$  life, for the ISO life-calculation method.

<sup>(2)</sup>Consult your Timken engineer for instructions on use or review the Timken Engineering Manual on [timken.com/catalogs](http://timken.com/catalogs).

<sup>(3)</sup>Based on  $90 \times 10^6$  revolutions  $L_{10}$  life, for The Timken Company life-calculation method.  $C_{90}$  and  $C_{a90}$  are radial and thrust values.

Bearing Dimensions											Geometry Factors			Bearing Weight
Width B	Width C	Eff. Ctr. a <sup>(4)</sup>	Shaft			Housing			Cage		G <sub>1</sub>	G <sub>2</sub>	C <sub>g</sub>	
			Max Shaft Fillet Radius R <sup>(5)</sup>	Backing Shoulder Dia. d <sub>a</sub>	Backing Shoulder Dia. d <sub>b</sub>	Max Housing Fillet Radius r <sup>(5)</sup>	Backing Shoulder Dia. D <sub>a</sub>	Backing Shoulder Dia. D <sub>b</sub>	A <sub>a</sub> <sup>(6)</sup>	A <sub>b</sub> <sup>(7)</sup>				
mm in.	mm in.	mm in.	mm in.	mm in.	mm in.	mm in.	mm in.	mm in.	mm in.	mm in.				kg lbs.
47.625 1.8750	34.925 1.3750	2.3 0.09	3.5 0.14	141.0 5.55	148.0 5.83	3.3 0.13	208.0 8.19	196.0 7.72	4.8 0.18	2.0 0.08	362.9	68.5	0.1338	6.96 15.35
49.428 1.9460	38.100 1.5000	13.2 0.52	3.5 0.14	144.0 5.65	151.0 5.94	3.3 0.13	213.0 8.38	197.0 7.76	8.2 0.32	4.8 0.19	237.1	44.6	0.1311	8.27 18.22
49.428 1.9460	38.100 1.5000	13.5 0.53	3.5 0.14	143.0 5.63	156.0 6.14	3.3 0.13	219.3 8.63	200.0 7.87	9.0 0.35	6.4 0.26	295.4	39.0	0.1416	8.60 18.98
63.500 2.5000	49.212 1.9375	-14.0 -0.55	6.4 0.25	142.0 5.59	154.0 6.06	3.3 0.13	217.0 8.54	209.0 8.23	6.4 0.25	3.8 0.15	453.9	59.4	0.1323	11.74 25.89
63.500 2.5000	49.212 1.9375	-14.0 -0.55	6.4 0.25	142.0 5.59	154.0 6.06	3.3 0.13	217.0 8.54	213.0 8.39	6.4 0.25	3.8 0.15	453.9	59.4	0.1323	13.10 28.87
63.500 2.5000	47.625 1.8750	-13.5 -0.53	3.3 0.13	144.0 5.67	148.0 5.83	4.8 0.19	224.0 8.82	220.0 8.66	8.5 0.33	1.6 0.07	416.6	57.3	0.1279	13.60 30.00
66.675 2.6250	47.625 1.8750	-12.2 -0.48	6.4 0.25	149.0 5.87	159.0 6.26	3.3 0.13	238.0 9.37	227.0 8.94	9.7 0.38	3.6 0.14	555.5	73.5	0.1459	15.46 34.07
82.550 3.2500	61.912 2.4375	-23.4 -0.92	9.7 0.38	148.0 5.83	164.0 6.46	6.4 0.25	233.6 9.20	223.0 8.78	7.0 0.27	0.0 0.00	529.8	44.8	0.1329	17.87 39.38
87.312 3.4375	57.150 2.2500	-26.7 -1.05	13.5 0.53	150.0 5.91	174.0 6.85	6.4 0.25	263.7 10.38	255.0 10.04	12.6 0.49	1.1 0.05	601.3	57.7	0.1083	25.30 55.78
87.312 3.4375	57.150 2.2500	-26.7 -1.05	13.5 0.53	150.0 5.91	174.0 6.85	6.4 0.25	263.7 10.38	258.0 10.16	12.6 0.49	1.1 0.05	601.3	57.7	0.1083	26.60 58.65
82.550 3.2500	57.150 2.2500	1.8 0.07	6.4 0.25	172.0 6.77	182.0 7.17	6.4 0.25	288.0 11.34	260.0 10.24	21.4 0.84	8.9 0.35	514.3	55.6	0.1333	29.56 65.16
82.550 3.2500	57.150 2.2500	1.8 0.07	6.4 0.25	172.0 6.77	182.0 7.17	6.4 0.25	288.0 11.34	262.0 10.31	21.4 0.84	8.9 0.35	514.3	55.6	0.1333	30.82 67.94
49.428 1.9460	38.100 1.5000	13.5 0.53	3.5 0.14	143.0 5.63	156.0 6.14	3.3 0.13	219.3 8.63	200.0 7.87	9.0 0.35	6.4 0.26	295.4	39.0	0.1416	8.54 18.84
31.750 1.2500	25.400 1.0000	16.5 0.65	3.5 0.14	138.0 5.43	144.0 5.67	3.3 0.13	183.0 7.20	170.0 6.69	4.4 0.17	0.9 0.04	218.2	71.4	0.1783	3.07 6.76
47.625 1.8750	34.925 1.3750	-1.8 -0.07	3.3 0.13	140.0 5.51	146.0 5.75	3.3 0.13	196.0 7.72	186.0 7.32	5.3 0.21	2.8 0.11	326.4	62.0	0.1269	5.76 12.71
63.500 2.5000	49.950 1.9665	-14.0 -0.55	6.4 0.25	145.0 5.71	157.0 6.18	3.3 0.13	217.0 8.54	208.0 8.19	6.4 0.25	3.8 0.15	453.9	59.4	0.1323	11.54 25.45
27.000 1.0630	21.000 0.8268	8.9 0.35	6.0 0.24	137.0 5.39	149.0 5.87	3.0 0.12	179.0 7.05	172.0 6.77	2.3 0.09	4.1 0.17	192.2	60.3	0.1064	2.15 4.73

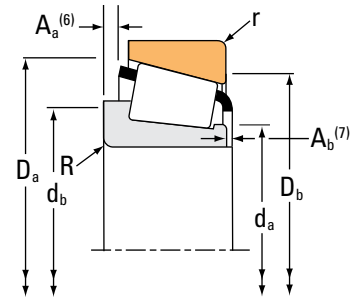
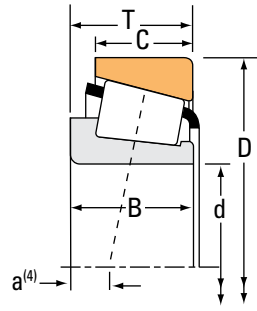
(4) Negative value indicates effective center inside cone (inner-ring) backface.  
 (5) These maximum fillet radii will be cleared by the bearing corners.  
 (6) Negative value indicates cage extends beyond cone (inner-ring) backface.  
 (7) Negative value indicates cage that does not extend beyond cone (inner-ring) front face.

Continued on next page.

# TAPERED ROLLER BEARINGS

## SINGLE-ROW • TYPE TS

### TYPE TS



Bearing Dimensions			Load Ratings							Part Number		
Bore d	O.D. D	Width T	Dynamic <sup>(1)</sup>		Factors <sup>(2)</sup>		Dynamic <sup>(3)</sup>		Factors <sup>(2)</sup>	Static	Inner	Outer
			C <sub>1</sub>	e	Y	C <sub>90</sub>	C <sub>a90</sub>	K	C <sub>0</sub>			
mm in.	mm in.	mm in.	N lbf			N lbf	N lbf			N lbf		
130.000 5.1181	185.000 7.2835	29.000 1.1417	196000 44000	0.47	1.27	50800 11400	41100 9250	1.24		283000 63600	JP13049	JP13010
130.000 5.1181	206.375 8.1250	47.625 1.8750	378000 85000	0.46	1.31	98000 22000	77000 17300	1.27		593000 133000	797	792
130.000 5.1181	230.000 9.0551	63.500 2.5000	629000 141000	0.37	1.62	163000 36700	103000 23200	1.58		931000 209000	95512X	95905
130.000 5.1181	234.950 9.2500	63.500 2.5000	629000 141000	0.37	1.62	163000 36700	103000 23200	1.58		931000 209000	95512X	95925
130.000 5.1181	234.975 9.2510	63.500 2.5000	629000 141000	0.37	1.62	163000 36700	103000 23200	1.58		931000 209000	95512X	95928
130.175 5.1250	196.850 7.7500	46.038 1.8125	368000 82600	0.34	1.74	95300 21400	56100 12600	1.70		625000 141000	67389	67322
130.175 5.1250	203.200 8.0000	46.038 1.8125	368000 82600	0.34	1.74	95300 21400	56100 12600	1.70		625000 141000	67389	67320
130.175 5.1250	206.375 8.1250	47.625 1.8750	378000 85000	0.46	1.31	98000 22000	77000 17300	1.27		593000 133000	799A	792
133.350 5.2500	173.038 6.8125	19.050 0.7500	96400 21700	0.35	1.72	25000 5620	14900 3350	1.68		170000 38300	LL327049	LL327010
133.350 5.2500	177.008 6.9688	25.400 1.0000	147000 33100	0.35	1.72	38100 8570	22700 5110	1.68		289000 65000	L327249	L327210
133.350 5.2500	190.500 7.5000	39.688 1.5625	283000 63600	0.32	1.87	73300 16500	40300 9060	1.82		542000 122000	48385	48320
133.350 5.2500	196.850 7.7500	46.038 1.8125	368000 82600	0.34	1.74	95300 21400	56100 12600	1.70		625000 141000	67390	67322
133.350 5.2500	196.850 7.7500	46.038 1.8125	368000 82600	0.34	1.74	95300 21400	56100 12600	1.70		625000 141000	67391	67322
133.350 5.2500	203.200 8.0000	46.038 1.8125	368000 82600	0.34	1.74	95300 21400	56100 12600	1.70		625000 141000	67390	67320
133.350 5.2500	203.200 8.0000	46.038 1.8125	368000 82600	0.34	1.74	95300 21400	56100 12600	1.70		625000 141000	67391	67320
133.350 5.2500	214.975 8.4636	47.625 1.8750	382000 85900	0.49	1.23	99000 22300	82600 18600	1.20		614000 138000	74525	74845
133.350 5.2500	215.900 8.5000	47.625 1.8750	382000 85900	0.49	1.23	99000 22300	82600 18600	1.20		614000 138000	74525	74850

<sup>(1)</sup>Based on 1 x 10<sup>6</sup> revolutions L<sub>10</sub> life, for the ISO life-calculation method.

<sup>(2)</sup>Consult your Timken engineer for instructions on use or review the Timken Engineering Manual on timken.com/catalogs.

<sup>(3)</sup>Based on 90 x 10<sup>6</sup> revolutions L<sub>10</sub> life, for The Timken Company life-calculation method. C<sub>90</sub> and C<sub>a90</sub> are radial and thrust values.

Bearing Dimensions											Geometry Factors			Bearing Weight
Width B	Width C	Eff. Ctr. a <sup>(4)</sup>	Shaft			Housing			Cage		G <sub>1</sub>	G <sub>2</sub>	C <sub>g</sub>	
			Max Shaft Fillet Radius R <sup>(5)</sup>	Backing Shoulder Dia. d <sub>a</sub>	Backing Shoulder Dia. d <sub>b</sub>	Max Housing Fillet Radius r <sup>(5)</sup>	Backing Shoulder Dia. D <sub>a</sub>	Backing Shoulder Dia. D <sub>b</sub>	A <sub>a</sub> <sup>(6)</sup>	A <sub>b</sub> <sup>(7)</sup>				
mm in.	mm in.	mm in.	mm in.	mm in.	mm in.	mm in.	mm in.	mm in.	mm in.	mm in.				kg lbs.
27.000 1.0630	21.000 0.8268	8.9 0.35	3.0 0.12	137.0 5.39	143.0 5.63	3.0 0.12	179.0 7.05	172.0 6.77	2.3 0.09	4.1 0.17	192.2	60.3	0.1064	2.16 4.76
47.625 1.8750	34.925 1.3750	-1.8 -0.07	3.5 0.14	141.0 5.55	148.0 5.83	3.3 0.13	196.0 7.72	186.0 7.32	5.3 0.21	2.8 0.11	326.4	62.0	0.1269	5.65 12.47
63.500 2.5000	49.212 1.9375	-14.0 -0.55	6.0 0.24	145.0 5.71	156.0 6.14	3.3 0.13	217.0 8.54	207.0 8.15	6.4 0.25	3.8 0.15	453.9	59.4	0.1323	10.75 23.70
63.500 2.5000	49.212 1.9375	-14.0 -0.55	6.0 0.24	145.0 5.71	156.0 6.14	3.3 0.13	217.0 8.54	209.0 8.23	6.4 0.25	3.8 0.15	453.9	59.4	0.1323	11.44 25.24
63.500 2.5000	49.212 1.9375	-14.0 -0.55	6.0 0.24	145.0 5.71	156.0 6.14	3.3 0.13	217.0 8.54	209.0 8.23	6.4 0.25	3.8 0.15	453.9	59.4	0.1323	11.42 25.18
46.038 1.8125	38.100 1.5000	-6.4 -0.25	3.5 0.14	141.0 5.55	147.0 5.79	3.3 0.13	189.0 7.44	180.0 7.09	4.2 0.16	1.4 0.06	383.7	70.1	0.1220	4.82 10.63
46.038 1.8125	38.100 1.5000	-6.4 -0.25	3.5 0.14	141.0 5.55	147.0 5.79	3.3 0.13	191.0 7.52	183.0 7.20	4.2 0.16	1.4 0.06	383.7	70.1	0.1220	5.42 11.94
47.625 1.8750	34.925 1.3750	-1.8 -0.07	3.5 0.14	142.0 5.59	148.0 5.83	3.3 0.13	196.0 7.72	186.0 7.32	5.3 0.21	2.8 0.11	326.4	62.0	0.1269	5.64 12.44
17.462 0.6875	14.288 0.5625	7.6 0.30	1.5 0.06	139.0 5.47	141.0 5.55	1.5 0.06	167.0 6.57	164.0 6.46	1.4 0.05	2.0 0.08	187.7	146.2	0.1377	1.00 2.21
26.195 1.0313	20.638 0.8125	4.1 0.16	1.5 0.06	140.0 5.51	142.0 5.59	1.5 0.06	171.0 6.73	167.0 6.57	0.7 0.03	1.7 0.07	280.1	155.8	0.1585	1.72 3.78
39.688 1.5625	33.338 1.3125	-4.1 -0.16	3.5 0.14	142.0 5.59	148.0 5.83	3.3 0.13	184.0 7.24	177.0 6.97	2.8 0.11	1.2 0.05	403.8	105.1	0.1209	3.58 7.89
46.038 1.8125	38.100 1.5000	-6.4 -0.25	3.5 0.14	144.0 5.67	150.0 5.91	3.3 0.13	189.0 7.44	180.0 7.09	4.2 0.16	1.4 0.06	383.7	70.1	0.1220	4.58 10.10
46.038 1.8125	38.100 1.5000	-6.4 -0.25	8.0 0.31	143.0 5.63	157.0 6.18	3.3 0.13	189.0 7.44	180.0 7.09	4.2 0.16	1.4 0.06	383.7	70.1	0.1220	4.55 10.02
46.038 1.8125	38.100 1.5000	-6.4 -0.25	3.5 0.14	144.0 5.67	150.0 5.91	3.3 0.13	191.0 7.52	183.0 7.20	4.2 0.16	1.4 0.06	383.7	70.1	0.1220	5.18 11.42
46.038 1.8125	38.100 1.5000	-6.4 -0.25	8.0 0.31	143.0 5.63	157.0 6.18	3.3 0.13	191.0 7.52	183.0 7.20	4.2 0.16	1.4 0.06	383.7	70.1	0.1220	5.15 11.34
47.625 1.8750	34.925 1.3750	2.3 0.09	3.5 0.14	146.0 5.75	152.0 5.98	3.3 0.13	208.0 8.19	196.0 7.72	4.8 0.18	2.0 0.08	362.9	68.5	0.1338	6.37 14.05
47.625 1.8750	34.925 1.3750	2.3 0.09	3.5 0.14	146.0 5.75	152.0 5.98	3.3 0.13	208.0 8.19	196.0 7.72	4.8 0.18	2.0 0.08	362.9	68.5	0.1338	6.48 14.28

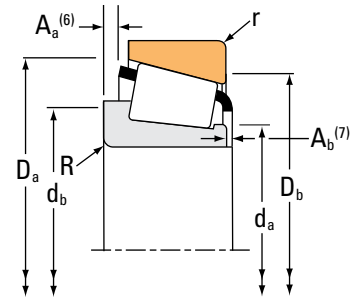
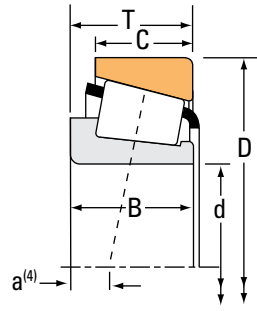
(4) Negative value indicates effective center inside cone (inner-ring) backface.  
 (5) These maximum fillet radii will be cleared by the bearing corners.  
 (6) Negative value indicates cage extends beyond cone (inner-ring) backface.  
 (7) Negative value indicates cage that does not extend beyond cone (inner-ring) front face.

Continued on next page.

# TAPERED ROLLER BEARINGS

## SINGLE-ROW • TYPE TS

### TYPE TS



Bearing Dimensions			Load Ratings							Part Number		
Bore d	O.D. D	Width T	Dynamic <sup>(1)</sup>		Factors <sup>(2)</sup>		Dynamic <sup>(3)</sup>		Factors <sup>(2)</sup>	Static	Inner	Outer
			C <sub>1</sub>	e	Y	C <sub>90</sub>	C <sub>a90</sub>	K	C <sub>0</sub>			
mm in.	mm in.	mm in.	N lbf			N lbf	N lbf			N lbf		
133.350 5.2500	215.900 8.5000	53.975 2.1250	382000 85900	0.49	1.23	99000 22300	82600 18600	1.20		614000 138000	74525	74853
133.350 5.2500	234.950 9.2500	63.500 2.5000	629000 141000	0.37	1.62	163000 36700	103000 23200	1.58		931000 209000	95525	95925
133.350 5.2500	234.950 9.2500	63.500 2.5000	629000 141000	0.37	1.62	163000 36700	103000 23200	1.58		931000 209000	95528	95925
136.525 5.3750	190.500 7.5000	39.688 1.5625	283000 63600	0.32	1.87	73300 16500	40300 9060	1.82		542000 122000	48393	48320
136.525 5.3750	203.200 8.0000	39.688 1.5625	283000 63600	0.32	1.87	73300 16500	40300 9060	1.82		542000 122000	48393	48328
136.525 5.3750	215.900 8.5000	47.625 1.8750	382000 85900	0.49	1.23	99000 22300	82600 18600	1.20		614000 138000	74537	74850
136.525 5.3750	217.488 8.5625	47.625 1.8750	382000 85900	0.49	1.23	99000 22300	82600 18600	1.20		614000 138000	74537	74856
136.525 5.3750	228.600 9.0000	57.150 2.2500	520000 117000	0.42	1.43	135000 30300	97200 21800	1.39		809000 182000	896	892
139.700 5.5000	187.325 7.3750	28.575 1.1250	227000 51000	0.36	1.69	58800 13200	35700 8030	1.65		375000 84300	LM328448	LM328410
139.700 5.5000	214.975 8.4636	47.625 1.8750	382000 85900	0.49	1.23	99000 22300	82600 18600	1.20		614000 138000	74550	74845
139.700 5.5000	215.900 8.5000	47.625 1.8750	382000 85900	0.49	1.23	99000 22300	82600 18600	1.20		614000 138000	74550	74850
139.700 5.5000	215.900 8.5000	47.625 1.8750	382000 85900	0.49	1.23	99000 22300	82600 18600	1.20		614000 138000	74550A	74850
139.700 5.5000	222.250 8.7500	34.925 1.3750	293000 65800	0.44	1.37	75900 17100	56800 12800	1.34		342000 77000	73551	73875
139.700 5.5000	228.600 9.0000	57.150 2.2500	520000 117000	0.42	1.43	135000 30300	97200 21800	1.39		809000 182000	898	892
139.700 5.5000	228.600 9.0000	57.150 2.2500	520000 117000	0.42	1.43	135000 30300	97200 21800	1.39		809000 182000	898A	892
139.700 5.5000	236.538 9.3125	57.150 2.2500	597000 134000	0.32	1.88	155000 34800	84500 19000	1.83		932000 210000	HM231132	HM231110
139.700 5.5000	241.300 9.5000	57.150 2.2500	597000 134000	0.32	1.88	155000 34800	84500 19000	1.83		932000 210000	HM231132	HM231115

<sup>(1)</sup>Based on  $1 \times 10^6$  revolutions  $L_{10}$  life, for the ISO life-calculation method.

<sup>(2)</sup>Consult your Timken engineer for instructions on use or review the Timken Engineering Manual on [timken.com/catalogs](http://timken.com/catalogs).

<sup>(3)</sup>Based on  $90 \times 10^6$  revolutions  $L_{10}$  life, for The Timken Company life-calculation method.  $C_{90}$  and  $C_{a90}$  are radial and thrust values.



Bearing Dimensions											Geometry Factors			Bearing Weight
Width B	Width C	Eff. Ctr. a <sup>(4)</sup>	Shaft			Housing			Cage		G <sub>1</sub>	G <sub>2</sub>	C <sub>g</sub>	
			Max Shaft Fillet Radius R <sup>(5)</sup>	Backing Shoulder Dia. d <sub>a</sub>	Backing Shoulder Dia. d <sub>b</sub>	Max Housing Fillet Radius r <sup>(5)</sup>	Backing Shoulder Dia. D <sub>a</sub>	Backing Shoulder Dia. D <sub>b</sub>	A <sub>a</sub> <sup>(6)</sup>	A <sub>b</sub> <sup>(7)</sup>				
mm in.	mm in.	mm in.	mm in.	mm in.	mm in.	mm in.	mm in.	mm in.	mm in.	mm in.				kg lbs.
47.625 1.8750	47.625 1.8750	2.3 0.09	3.5 0.14	146.0 5.75	152.0 5.98	3.3 0.13	209.0 8.23	196.0 7.72	4.8 0.18	2.0 0.08	362.9	68.5	0.1338	7.15 15.77
63.500 2.5000	49.212 1.9375	-14.0 -0.55	9.7 0.38	148.0 5.83	166.0 6.54	3.3 0.13	217.0 8.54	209.0 8.23	6.4 0.25	3.8 0.15	453.9	59.4	0.1323	11.00 24.26
63.500 2.5000	49.212 1.9375	-14.0 -0.55	4.8 0.19	148.0 5.83	157.0 6.18	3.3 0.13	217.0 8.54	209.0 8.23	6.4 0.25	3.8 0.15	453.9	59.4	0.1323	11.12 24.53
39.688 1.5625	33.338 1.3125	-4.1 -0.16	3.5 0.14	144.0 5.67	151.0 5.94	3.3 0.13	184.0 7.24	177.0 6.97	2.8 0.11	1.2 0.05	403.8	105.1	0.1209	3.38 7.45
39.688 1.5625	33.338 1.3125	-4.1 -0.16	3.5 0.14	144.0 5.67	151.0 5.94	3.3 0.13	186.0 7.32	182.0 7.17	2.8 0.11	1.2 0.05	403.8	105.1	0.1209	4.39 9.67
47.625 1.8750	34.925 1.3750	2.3 0.09	3.5 0.14	148.0 5.83	155.0 6.10	3.3 0.13	208.0 8.19	196.0 7.72	4.8 0.18	2.0 0.08	362.9	68.5	0.1338	6.23 13.72
47.625 1.8750	34.925 1.3750	2.3 0.09	3.5 0.14	148.0 5.83	155.0 6.10	3.3 0.13	209.0 8.23	197.0 7.76	4.8 0.18	2.0 0.08	362.9	68.5	0.1338	6.35 14.01
57.150 2.2500	44.450 1.7500	-6.1 -0.24	3.5 0.14	150.0 5.91	156.0 6.14	3.3 0.13	216.0 8.50	205.0 8.07	6.4 0.25	1.4 0.06	430.5	78.3	0.1355	9.00 19.84
29.370 1.1563	23.020 0.9063	3.6 0.14	1.5 0.06	147.0 5.79	149.0 5.87	1.5 0.06	182.0 7.17	176.0 6.93	1.1 0.04	1.9 0.08	336.5	179.4	0.1700	2.21 4.85
47.625 1.8750	34.925 1.3750	2.3 0.09	3.5 0.14	151.0 5.94	158.0 6.22	3.3 0.13	208.0 8.19	196.0 7.72	4.8 0.18	2.0 0.08	362.9	68.5	0.1338	5.86 12.93
47.625 1.8750	34.925 1.3750	2.3 0.09	3.5 0.14	151.0 5.94	158.0 6.22	3.3 0.13	208.0 8.19	196.0 7.72	4.8 0.18	2.0 0.08	362.9	68.5	0.1338	5.97 13.16
47.625 1.8750	34.925 1.3750	2.3 0.09	6.4 0.25	154.0 6.06	166.0 6.54	3.3 0.13	208.0 8.19	196.0 7.72	4.8 0.18	2.0 0.08	362.9	68.5	0.1338	5.96 13.13
31.623 1.2450	23.812 0.9375	6.4 0.25	3.5 0.14	150.0 5.91	156.0 6.14	3.3 0.13	207.0 8.15	204.0 8.03	5.7 0.22	4.0 0.16	244.4	82.0	0.1122	4.29 9.44
57.150 2.2500	44.450 1.7500	-6.1 -0.24	3.5 0.14	153.0 6.02	160.0 6.30	3.3 0.13	216.0 8.50	205.0 8.07	6.4 0.25	1.4 0.06	430.5	78.3	0.1355	8.69 19.16
57.150 2.2500	44.450 1.7500	-6.1 -0.24	6.4 0.25	153.0 6.02	165.0 6.50	3.3 0.13	216.0 8.50	205.0 8.07	6.4 0.25	1.4 0.06	430.5	78.3	0.1355	8.64 19.05
56.642 2.2300	44.450 1.7500	-11.4 -0.45	3.5 0.14	156.0 6.14	160.0 6.30	3.3 0.13	224.0 8.82	217.0 8.54	4.2 0.16	3.7 0.15	532.8	85.9	0.1327	9.93 21.87
56.642 2.2300	44.450 1.7500	-11.4 -0.45	3.5 0.14	156.0 6.14	160.0 6.30	3.3 0.13	224.0 8.82	219.0 8.62	4.2 0.16	3.7 0.15	532.8	85.9	0.1327	10.55 23.24

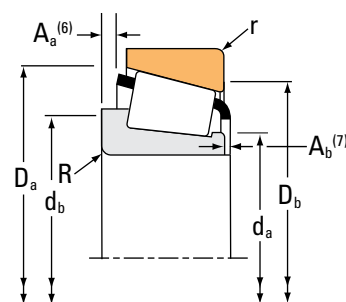
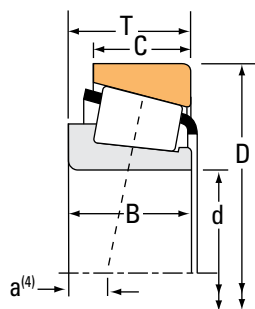
<sup>(4)</sup>Negative value indicates effective center inside cone (inner-ring) backface.  
<sup>(5)</sup>These maximum fillet radii will be cleared by the bearing corners.  
<sup>(6)</sup>Negative value indicates cage extends beyond cone (inner-ring) backface.  
<sup>(7)</sup>Negative value indicates cage that does not extend beyond cone (inner-ring) front face.

Continued on next page.

# TAPERED ROLLER BEARINGS

## SINGLE-ROW • TYPE TS

### TYPE TS



Bearing Dimensions			Load Ratings							Part Number		
Bore d	O.D. D	Width T	Dynamic <sup>(1)</sup>		Factors <sup>(2)</sup>		Dynamic <sup>(3)</sup>		Factors <sup>(2)</sup>	Static	Inner	Outer
			C <sub>1</sub>	e	Y	C <sub>90</sub>	C <sub>a90</sub>	K	C <sub>0</sub>			
mm in.	mm in.	mm in.	N lbf			N lbf	N lbf			N lbf		
139.700 5.5000	254.000 10.0000	66.675 2.6250	660000 148000	0.41	1.47	171000 38500	119000 26800	1.43		1030000 231000	99550	99100
139.700 5.5000	288.925 11.3750	82.550 3.2500	1140000 257000	0.32	1.88	296000 66600	162000 36300	1.83		1340000 302000	HH231649	HH231610
139.700 5.5000	295.275 11.6250	82.550 3.2500	1140000 257000	0.32	1.88	296000 66600	162000 36300	1.83		1340000 302000	HH231649	HH231615
139.700 5.5000	307.975 12.1250	88.900 3.5000	1150000 259000	0.33	1.84	299000 67200	167000 37500	1.79		1580000 354000	HH234032	HH234010
139.700 5.5000	307.975 12.1250	88.900 3.5000	1150000 259000	0.33	1.84	299000 67200	167000 37500	1.79		1580000 354000	HH234031	HH234010
140.000 5.5118	195.000 7.6772	29.000 1.1417	203000 45700	0.50	1.19	52700 11800	45400 10200	1.16		304000 68400	JP14049	JP14010
142.875 5.6250	193.675 7.6250	28.575 1.1250	196000 44200	0.37	1.63	50900 11400	32100 7220	1.59		394000 88600	36686	36620
142.875 5.6250	200.025 7.8750	41.275 1.6250	286000 64400	0.34	1.78	74300 16700	42800 9610	1.74		560000 126000	48684	48620
142.875 5.6250	200.025 7.8750	41.275 1.6250	286000 64400	0.34	1.78	74300 16700	42800 9610	1.74		560000 126000	48685	48620
142.875 5.6250	222.250 8.7500	34.925 1.3750	293000 65800	0.44	1.37	75900 17100	56800 12800	1.34		342000 77000	73562	73875
142.875 5.6250	236.538 9.3125	57.150 2.2500	515000 116000	0.44	1.36	134000 30000	101000 22700	1.32		810000 182000	82562A	82931
142.875 5.6250	241.300 9.5000	57.150 2.2500	597000 134000	0.32	1.88	155000 34800	84500 19000	1.83		932000 210000	HM231136	HM231115
142.875 5.6250	241.300 9.5000	57.150 2.2500	515000 116000	0.44	1.36	134000 30000	101000 22700	1.32		810000 182000	82562A	82950
146.050 5.7500	188.120 7.4063	22.225 0.8750	113000 25400	0.38	1.57	29300 6590	19200 4310	1.53		214000 48200	LL529749	LL529710
146.050 5.7500	193.675 7.6250	28.575 1.1250	196000 44200	0.37	1.63	50900 11400	32100 7220	1.59		394000 88600	36690	36620
146.050 5.7500	193.675 7.6250	28.575 1.1250	196000 44200	0.37	1.63	50900 11400	32100 7220	1.59		394000 88600	36691	36620
146.050 5.7500	203.200 8.0000	28.575 1.1250	196000 44200	0.37	1.63	50900 11400	32100 7220	1.59		394000 88600	36690	36626

<sup>(1)</sup>Based on 1 x 10<sup>6</sup> revolutions L<sub>10</sub> life, for the ISO life-calculation method.

<sup>(2)</sup>Consult your Timken engineer for instructions on use or review the Timken Engineering Manual on timken.com/catalogs.

<sup>(3)</sup>Based on 90 x 10<sup>6</sup> revolutions L<sub>10</sub> life, for The Timken Company life-calculation method. C<sub>90</sub> and C<sub>a90</sub> are radial and thrust values.

Bearing Dimensions											Geometry Factors			Bearing Weight
Width B	Width C	Eff. Ctr. a <sup>(4)</sup>	Shaft			Housing			Cage		G <sub>1</sub>	G <sub>2</sub>	C <sub>g</sub>	
			Max Shaft Fillet Radius R <sup>(5)</sup>	Backing Shoulder Dia. d <sub>a</sub>	Shoulder Dia. d <sub>b</sub>	Max Housing Fillet Radius r <sup>(5)</sup>	Backing Shoulder Dia. D <sub>a</sub>	Shoulder Dia. D <sub>b</sub>	A <sub>a</sub> <sup>(6)</sup>	A <sub>b</sub> <sup>(7)</sup>				
mm in.	mm in.	mm in.	mm in.	mm in.	mm in.	mm in.	mm in.	mm in.	mm in.	mm in.				kg lbs.
66.675 2.6250	47.625 1.8750	-12.2 -0.48	7.0 0.28	156.0 6.14	170.0 6.69	3.3 0.13	238.0 9.37	227.0 8.94	9.7 0.38	3.6 0.14	555.5	73.5	0.1459	14.02 30.90
87.312 3.4375	57.150 2.2500	-26.7 -1.05	9.7 0.38	161.0 6.34	177.0 6.97	6.4 0.25	263.7 10.38	255.0 10.04	12.6 0.49	1.1 0.05	601.3	57.7	0.1083	23.73 52.31
87.312 3.4375	57.150 2.2500	-26.7 -1.05	9.7 0.38	161.0 6.34	177.0 6.97	6.4 0.25	263.7 10.38	258.0 10.16	12.6 0.49	1.1 0.05	601.3	57.7	0.1083	25.03 55.18
93.662 3.6875	66.675 2.6250	-26.4 -1.04	9.7 0.38	167.9 6.61	180.0 7.09	6.8 0.27	285.5 11.24	276.1 10.87	10.5 0.41	1.1 0.05	718.4	62.1	0.1157	31.27 68.92
93.662 3.6875	66.675 2.6250	-26.4 -1.04	9.7 0.38	167.9 6.61	180.0 7.09	6.8 0.27	285.5 11.24	276.1 10.87	12.5 0.49	-0.8 -0.03	718.4	62.1	0.1157	31.13 68.61
27.000 1.0630	21.000 0.8268	11.9 0.47	3.0 0.12	148.0 5.83	153.0 6.02	3.0 0.12	189.0 7.44	182.0 7.17	2.6 0.10	4.2 0.17	219.5	68.2	0.1133	2.29 5.06
28.575 1.1250	23.020 0.9063	4.8 0.19	1.5 0.06	151.0 5.94	153.0 6.02	1.5 0.06	188.0 7.40	182.0 7.17	1.2 0.04	2.7 0.11	366.1	152.5	0.1768	2.41 5.31
39.688 1.5625	34.130 1.3437	-3.0 -0.12	8.0 0.31	151.0 5.94	166.0 6.54	3.3 0.13	193.0 7.60	185.0 7.28	2.8 0.11	2.5 0.10	439.6	130.5	0.1261	3.75 8.25
39.688 1.5625	34.130 1.3437	-3.0 -0.12	3.5 0.14	151.0 5.94	158.0 6.22	3.3 0.13	193.0 7.60	185.0 7.28	2.8 0.11	2.5 0.10	439.6	130.5	0.1261	3.86 8.50
31.623 1.2450	23.812 0.9375	6.4 0.25	3.5 0.14	152.0 5.98	159.0 6.26	3.3 0.13	207.0 8.15	204.0 8.03	5.7 0.22	4.0 0.16	244.4	82.0	0.1122	4.11 9.05
56.642 2.2300	44.450 1.7500	-3.6 -0.14	8.0 0.31	157.0 6.18	172.0 6.77	3.3 0.13	226.0 8.90	213.0 8.39	5.7 0.22	2.2 0.09	460.5	81.1	0.1405	9.46 20.84
56.642 2.2300	44.450 1.7500	-11.4 -0.45	3.5 0.14	158.0 6.22	162.0 6.38	3.3 0.13	224.0 8.82	219.0 8.62	4.2 0.16	3.7 0.15	532.8	85.9	0.1327	10.24 22.55
56.642 2.2300	44.450 1.7500	-3.6 -0.14	8.0 0.31	157.0 6.18	172.0 6.77	3.3 0.13	226.0 8.90	215.0 8.46	5.7 0.22	2.2 0.09	460.5	81.1	0.1405	10.08 22.21
20.638 0.8125	16.670 0.6563	9.4 0.37	1.5 0.06	152.0 5.98	155.0 6.10	1.5 0.06	182.0 7.17	179.0 7.05	0.4 0.01	1.9 0.08	248.3	185.9	0.1557	1.41 3.12
28.575 1.1250	23.020 0.9063	4.8 0.19	1.5 0.06	153.0 6.02	155.0 6.10	1.5 0.06	188.0 7.40	182.0 7.17	1.2 0.04	2.7 0.11	366.1	152.5	0.1768	2.25 4.96
28.575 1.1250	23.020 0.9063	4.8 0.19	4.8 0.19	153.0 6.02	162.0 6.38	1.5 0.06	188.0 7.40	182.0 7.17	1.2 0.04	2.7 0.11	366.1	152.5	0.1768	2.21 4.87
28.575 1.1250	23.020 0.9063	4.8 0.19	1.5 0.06	153.0 6.02	155.0 6.10	1.5 0.06	190.0 7.48	186.0 7.32	1.2 0.04	2.7 0.11	366.1	152.5	0.1768	2.78 6.14

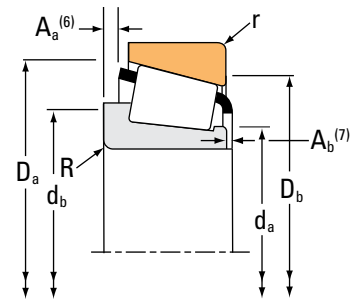
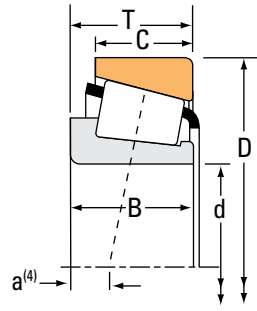
<sup>(4)</sup>Negative value indicates effective center inside cone (inner-ring) backface.  
<sup>(5)</sup>These maximum fillet radii will be cleared by the bearing corners.  
<sup>(6)</sup>Negative value indicates cage extends beyond cone (inner-ring) backface.  
<sup>(7)</sup>Negative value indicates cage that does not extend beyond cone (inner-ring) front face.

Continued on next page.

# TAPERED ROLLER BEARINGS

## SINGLE-ROW • TYPE TS

### TYPE TS



Bearing Dimensions			Load Ratings							Part Number		
Bore d	O.D. D	Width T	Dynamic <sup>(1)</sup>		Factors <sup>(2)</sup>		Dynamic <sup>(3)</sup>		Factors <sup>(2)</sup>	Static	Inner	Outer
			C <sub>1</sub>	e	Y	C <sub>90</sub>	C <sub>a90</sub>	K	C <sub>0</sub>			
mm in.	mm in.	mm in.	N lbf			N lbf	N lbf			N lbf		
146.050 5.7500	203.200 8.0000	45.100 1.7756	334000 75000	0.33	1.80	86500 19400	49200 11100	1.76		573000 129000	M229349	M229310
146.050 5.7500	203.200 8.0000	45.100 1.7756	334000 75000	0.33	1.80	86500 19400	49200 11100	1.76		573000 129000	M229349A	M229310
146.050 5.7500	236.538 9.3125	57.150 2.2500	515000 116000	0.44	1.36	134000 30000	101000 22700	1.32		810000 182000	82576	82931
146.050 5.7500	241.300 9.5000	57.150 2.2500	515000 116000	0.44	1.36	134000 30000	101000 22700	1.32		810000 182000	82576	82950
146.050 5.7500	241.300 9.5000	57.150 2.2500	597000 134000	0.32	1.88	155000 34800	84500 19000	1.83		932000 210000	HM231140	HM231115
146.050 5.7500	244.475 9.6250	47.625 1.8750	402000 90300	0.35	1.71	104000 23400	62700 14100	1.66		595000 134000	81575	81962
146.050 5.7500	254.000 10.0000	66.675 2.6250	660000 148000	0.41	1.47	171000 38500	119000 26800	1.43		1030000 231000	99575	99100
146.050 5.7500	268.288 10.5625	74.612 2.9375	784000 176000	0.39	1.55	203000 45700	135000 30300	1.51		1170000 263000	EE107057	107105
146.050 5.7500	304.800 12.0000	60.325 2.3750	775000 174000	0.33	1.80	201000 45200	114000 25700	1.76		871000 196000	EE750576	751200
146.050 5.7500	304.800 12.0000	88.900 3.5000	1160000 260000	0.73	0.82	300000 67500	374000 84100	0.80		1250000 282000	HH932145	HH932110
146.050 5.7500	307.975 12.1250	88.900 3.5000	1050000 237000	0.33	1.84	273000 61400	152000 34300	1.79		1480000 333000	EE450577	451212
146.050 5.7500	307.975 12.1250	88.900 3.5000	1150000 259000	0.33	1.84	299000 67200	167000 37500	1.79		1580000 354000	HH234040	HH234010
146.050 5.7500	311.150 12.2500	88.900 3.5000	1160000 260000	0.73	0.82	300000 67500	374000 84100	0.80		1250000 282000	HH932145	HH932115
149.225 5.8750	236.538 9.3125	57.150 2.2500	597000 134000	0.32	1.88	155000 34800	84500 19000	1.83		932000 210000	HM231149	HM231110
149.225 5.8750	236.538 9.3125	57.150 2.2500	597000 134000	0.32	1.88	155000 34800	84500 19000	1.83		932000 210000	HM231148	HM231110
149.225 5.8750	241.300 9.5000	57.150 2.2500	597000 134000	0.32	1.88	155000 34800	84500 19000	1.83		932000 210000	HM231149	HM231115
149.225 5.8750	254.000 10.0000	66.675 2.6750	660000 148000	0.41	1.47	171000 38500	119000 26800	1.43		1030000 231000	99587	99100

<sup>(1)</sup>Based on  $1 \times 10^6$  revolutions  $L_{10}$  life, for the ISO life-calculation method.

<sup>(2)</sup>Consult your Timken engineer for instructions on use or review the Timken Engineering Manual on [timken.com/catalogs](http://timken.com/catalogs).

<sup>(3)</sup>Based on  $90 \times 10^6$  revolutions  $L_{10}$  life, for The Timken Company life-calculation method.  $C_{90}$  and  $C_{a90}$  are radial and thrust values.

Bearing Dimensions											Geometry Factors			Bearing Weight
Width B	Width C	Eff. Ctr. a <sup>(4)</sup>	Shaft			Housing			Cage		G <sub>1</sub>	G <sub>2</sub>	C <sub>g</sub>	
			Max Shaft Fillet Radius R <sup>(5)</sup>	Backing Shoulder Dia. d <sub>a</sub>	Backing Shoulder Dia. d <sub>b</sub>	Max Housing Fillet Radius r <sup>(5)</sup>	Backing Shoulder Dia. D <sub>a</sub>	Backing Shoulder Dia. D <sub>b</sub>	A <sub>a</sub> <sup>(6)</sup>	A <sub>b</sub> <sup>(7)</sup>				
mm in.	mm in.	mm in.	mm in.	mm in.	mm in.	mm in.	mm in.	mm in.	mm in.	mm in.				kg lbs.
40.000 1.5748	38.100 1.5000	-2.5 -0.10	3.5 0.14	154.0 6.06	160.0 6.30	3.5 0.14	197.0 7.76	187.0 7.36	1.5 0.06	2.8 0.11	401.6	98.0	0.1220	4.01 8.83
40.000 1.5748	38.100 1.5000	-2.5 -0.10	5.0 0.20	154.0 6.06	164.0 6.46	3.5 0.14	197.0 7.76	187.0 7.36	1.5 0.06	2.8 0.11	401.6	98.0	0.1220	4.00 8.81
56.642 2.2300	44.450 1.7500	-3.6 -0.14	3.5 0.14	160.0 6.30	166.0 6.54	3.3 0.13	226.0 8.90	213.0 8.39	5.7 0.22	2.2 0.09	460.5	81.1	0.1405	9.22 20.32
56.642 2.2300	44.450 1.7500	-3.6 -0.14	3.5 0.14	160.0 6.30	166.0 6.54	3.3 0.13	226.0 8.90	215.0 8.46	5.7 0.22	2.2 0.09	460.5	81.1	0.1405	9.84 21.69
56.642 2.2300	44.450 1.7500	-11.4 -0.45	3.5 0.14	160.0 6.30	164.0 6.46	3.3 0.13	224.0 8.82	219.0 8.62	4.2 0.16	3.7 0.15	532.8	85.9	0.1327	9.92 21.85
50.005 1.9687	33.338 1.3125	-5.3 -0.21	3.5 0.14	161.0 6.34	166.1 6.54	3.3 0.13	229.1 9.02	225.0 8.86	8.2 0.32	0.0 0.00	413.0	98.4	0.1250	8.23 18.13
66.675 2.6250	47.625 1.8750	-12.2 -0.48	7.0 0.28	162.0 6.38	175.0 6.89	3.3 0.13	238.0 9.37	227.0 8.94	9.7 0.38	3.6 0.14	555.5	73.5	0.1459	13.28 29.25
74.612 2.9375	57.150 2.2500	-15.0 -0.59	6.4 0.25	166.0 6.54	176.0 6.93	6.4 0.25	249.4 9.82	237.0 9.33	7.7 0.30	3.0 0.12	606.1	76.3	0.1163	17.55 38.67
61.912 2.4375	41.275 1.6250	-10.7 -0.42	3.3 0.13	172.0 6.77	167.0 6.57	6.4 0.25	272.0 10.71	270.0 10.63	6.6 0.26	3.5 0.14	431.4	54.4	0.0974	18.90 41.69
82.550 3.2500	57.150 2.2500	1.8 0.07	6.4 0.25	171.0 6.73	195.0 7.68	6.4 0.25	288.0 11.34	260.0 10.24	21.4 0.84	8.9 0.35	514.3	55.6	0.1333	26.95 59.41
93.662 3.6875	61.912 2.4375	-28.2 -1.11	9.7 0.38	172.0 6.77	185.0 7.28	6.9 0.27	274.8 10.82	269.0 10.59	17.8 0.70	-2.7 -0.10	747.4	76.3	0.1176	29.38 64.75
93.662 3.6875	66.675 2.6250	-26.4 -1.04	9.7 0.38	173.0 6.81	185.9 7.32	6.8 0.27	285.5 11.24	276.1 10.87	10.5 0.41	0.8 0.04	718.4	62.1	0.1157	30.22 66.61
82.550 3.2500	57.150 2.2500	1.8 0.07	6.4 0.25	171.0 6.73	195.0 7.68	6.4 0.25	288.0 11.34	262.0 10.31	21.4 0.84	8.9 0.35	514.3	55.6	0.1333	28.21 62.19
56.642 2.2300	44.450 1.7500	-11.4 -0.45	3.5 0.14	163.0 6.42	167.0 6.57	3.3 0.13	224.0 8.82	217.0 8.54	4.2 0.16	3.7 0.15	532.8	85.9	0.1327	8.97 19.76
56.642 2.2300	44.450 1.7500	-11.4 -0.45	6.4 0.25	163.0 6.42	172.0 6.77	3.3 0.13	224.0 8.82	217.0 8.54	4.2 0.16	3.7 0.15	532.8	85.9	0.1327	8.92 19.64
56.642 2.2300	44.450 1.7500	-11.4 -0.45	3.5 0.14	163.0 6.42	167.0 6.57	3.3 0.13	224.0 8.82	219.0 8.62	4.2 0.16	3.7 0.15	532.8	85.9	0.1327	9.59 21.13
66.675 2.6250	47.625 1.8750	-12.2 -0.48	7.0 0.28	170.0 6.69	181.0 7.13	3.3 0.13	238.0 9.37	227.0 8.94	9.7 0.38	3.6 0.14	555.5	73.5	0.1459	12.94 28.51

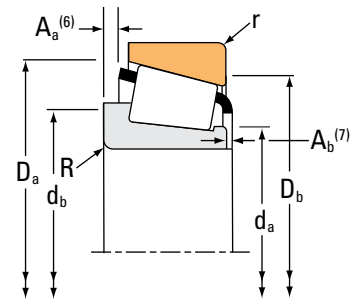
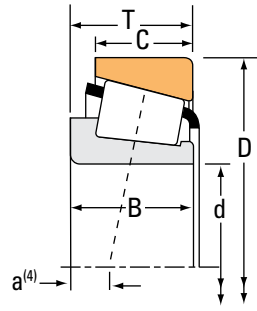
(4) Negative value indicates effective center inside cone (inner-ring) backface.  
 (5) These maximum fillet radii will be cleared by the bearing corners.  
 (6) Negative value indicates cage extends beyond cone (inner-ring) backface.  
 (7) Negative value indicates cage that does not extend beyond cone (inner-ring) front face.

Continued on next page.

# TAPERED ROLLER BEARINGS

## SINGLE-ROW • TYPE TS

### TYPE TS



Bearing Dimensions			Load Ratings							Part Number		
Bore d	O.D. D	Width T	Dynamic <sup>(1)</sup>		Factors <sup>(2)</sup>		Dynamic <sup>(3)</sup>		Factors <sup>(2)</sup>	Static	Inner	Outer
			C <sub>1</sub>	e	Y	C <sub>90</sub>	C <sub>a90</sub>	K	C <sub>0</sub>			
mm in.	mm in.	mm in.	N lbf			N lbf	N lbf		N lbf			
150.000 5.9055	203.200 8.0000	28.575 1.1250	194000 43500	0.46	1.31	50200 11300	39400 8860	1.27	339000 76100		JL730646	L730610
150.000 5.9055	205.000 8.0709	28.575 1.1250	183000 41100	0.46	1.31	47400 10700	37200 8370	1.27	339000 76100		JL730646	JL730612
150.000 5.9055	244.475 9.6250	47.625 1.8750	402000 90300	0.35	1.71	104000 23400	62700 14100	1.66	595000 134000		81590	81962
150.000 5.9055	245.000 9.6457	47.625 1.8750	402000 90300	0.35	1.71	104000 23400	62700 14100	1.66	595000 134000		81590	81964
150.812 5.9375	244.475 9.6250	47.625 1.8750	402000 90300	0.35	1.71	104000 23400	62700 14100	1.66	595000 134000		81593	81962
152.400 6.0000	192.088 7.5625	25.000 0.9843	143000 32000	0.42	1.44	37000 8310	26300 5920	1.40	277000 62200		L630349	L630310
152.400 6.0000	203.200 8.0000	28.575 1.1250	194000 43500	0.46	1.31	50200 11300	39400 8860	1.27	339000 76100		L730649	L730610
152.400 6.0000	203.200 8.0000	41.275 1.6250	283000 63700	0.35	1.73	73400 16500	43700 9810	1.68	556000 125000		LM330448	LM330410
152.400 6.0000	222.250 8.7500	46.830 1.8437	377000 84600	0.33	1.80	97600 21900	55600 12500	1.76	668000 150000		M231649	M231610
152.400 6.0000	244.475 9.6250	47.625 1.8750	402000 90300	0.35	1.71	104000 23400	62700 14100	1.66	595000 134000		81600	81962
152.400 6.0000	249.975 9.8415	66.675 2.6250	660000 148000	0.41	1.47	171000 38500	119000 26800	1.43	1030000 231000		99600	99097
152.400 6.0000	250.000 9.8425	66.675 2.6250	660000 148000	0.41	1.47	171000 38500	119000 26800	1.43	1030000 231000		99600	99098X
152.400 6.0000	254.000 10.0000	66.675 2.6250	660000 148000	0.41	1.47	171000 38500	119000 26800	1.43	1030000 231000		99600	99100
152.400 6.0000	268.288 10.5625	74.612 2.9375	784000 176000	0.39	1.55	203000 45700	135000 30300	1.51	1170000 263000		EE107060	107105
152.400 6.0000	285.750 11.2500	76.200 3.0000	715000 161000	0.40	1.49	185000 41700	128000 28700	1.45	1060000 237000		EE217060	217112
152.400 6.0000	307.975 12.1250	88.900 3.5000	1050000 237000	0.33	1.84	273000 61400	152000 34300	1.79	1480000 333000		EE450601	451212
152.400 6.0000	307.975 12.1250	88.900 3.5000	1220000 274000	0.33	1.84	316000 71100	177000 39700	1.79	1580000 354000		HH234049	HH234010

<sup>(1)</sup>Based on  $1 \times 10^6$  revolutions  $L_{10}$  life, for the ISO life-calculation method.

<sup>(2)</sup>Consult your Timken engineer for instructions on use or review the Timken Engineering Manual on [timken.com/catalogs](http://timken.com/catalogs).

<sup>(3)</sup>Based on  $90 \times 10^6$  revolutions  $L_{10}$  life, for The Timken Company life-calculation method.  $C_{90}$  and  $C_{a90}$  are radial and thrust values.

Bearing Dimensions											Geometry Factors			Bearing Weight
Width B	Width C	Eff. Ctr. a <sup>(4)</sup>	Shaft			Housing			Cage		G <sub>1</sub>	G <sub>2</sub>	C <sub>g</sub>	
			Max Shaft Fillet Radius R <sup>(5)</sup>	Backing Shoulder Dia. d <sub>a</sub>	Backing Shoulder Dia. d <sub>b</sub>	Max Housing Fillet Radius r <sup>(5)</sup>	Backing Shoulder Dia. D <sub>a</sub>	Backing Shoulder Dia. D <sub>b</sub>	A <sub>a</sub> <sup>(6)</sup>	A <sub>b</sub> <sup>(7)</sup>				
mm in.	mm in.	mm in.	mm in.	mm in.	mm in.	mm in.	mm in.	mm in.	mm in.	mm in.				kg lbs.
28.575 1.1250	21.438 0.8440	11.4 0.45	3.3 0.13	158.0 6.22	164.0 6.46	3.3 0.13	198.0 7.80	190.0 7.48	2.4 0.09	1.5 0.06	295.2	103.6	0.1763	2.48 5.48
28.575 1.1250	21.438 0.8440	11.4 0.45	3.3 0.13	158.0 6.22	164.0 6.46	3.3 0.13	198.0 7.80	190.0 7.48	2.4 0.09	1.5 0.06	295.2	103.6	0.1763	2.61 5.76
50.005 1.9687	33.338 1.3125	-5.3 -0.21	3.5 0.14	163.1 6.42	168.9 6.65	3.3 0.13	229.1 9.02	225.0 8.86	8.2 0.32	* *	413.0	98.4	0.1250	7.91 17.43
50.005 1.9687	33.338 1.3125	-5.3 -0.21	3.5 0.14	163.1 6.42	168.9 6.65	3.3 0.13	229.1 9.02	225.0 8.86	8.2 0.32	* *	413.0	98.4	0.1250	7.93 17.47
50.005 1.9687	33.338 1.3125	-5.3 -0.21	3.5 0.14	164.1 6.46	168.9 6.65	3.3 0.13	229.1 9.02	225.0 8.86	8.2 0.32	* *	413.0	98.4	0.1250	7.84 17.28
24.000 0.9449	19.000 0.7480	10.2 0.40	2.0 0.08	158.0 6.22	162.0 6.38	2.0 0.08	187.0 7.36	183.0 7.20	1.9 0.07	2.6 0.10	293.3	163.8	0.1698	1.56 3.44
28.575 1.1250	21.438 0.8440	11.4 0.45	3.3 0.13	160.0 6.30	165.0 6.50	3.3 0.13	198.0 7.80	190.0 7.48	2.4 0.09	1.5 0.06	295.2	103.6	0.1763	2.35 5.18
41.275 1.6250	34.925 1.3750	-1.8 -0.07	3.3 0.13	162.0 6.37	166.0 6.54	3.3 0.13	197.0 7.76	189.0 7.44	2.9 0.11	0.9 0.04	456.5	134.8	0.1289	3.53 7.79
46.830 1.8437	34.925 1.3750	-6.1 -0.24	3.5 0.14	163.0 6.42	169.0 6.65	1.5 0.06	213.0 8.39	207.0 8.15	5.3 0.21	2.3 0.09	486.5	120.1	0.1300	5.72 12.63
50.005 1.9687	33.338 1.3125	-5.3 -0.21	3.5 0.14	165.0 6.50	170.9 6.73	3.3 0.13	229.1 9.02	225.0 8.86	8.2 0.32	* *	413.0	98.4	0.1250	7.68 16.91
66.675 2.6250	53.400 2.1024	-12.2 -0.48	7.0 0.28	169.7 6.68	181.0 7.13	3.0 0.12	240.0 9.45	226.0 8.90	9.7 0.38	3.6 0.14	555.5	73.5	0.1459	12.09 26.66
66.675 2.6250	47.625 1.8750	-12.2 -0.48	7.0 0.28	169.7 6.68	181.0 7.13	3.3 0.13	238.0 9.37	226.0 8.90	9.7 0.38	3.6 0.14	555.5	73.5	0.1459	11.87 26.17
66.675 2.6250	47.625 1.8750	-12.2 -0.48	7.0 0.28	169.7 6.68	181.0 7.13	3.3 0.13	238.0 9.37	227.0 8.94	9.7 0.38	3.6 0.14	555.5	73.5	0.1459	12.49 27.53
74.612 2.9375	57.150 2.2500	-15.0 -0.59	6.4 0.25	171.0 6.73	181.0 7.13	6.4 0.25	249.4 9.82	237.0 9.33	7.7 0.30	3.0 0.12	606.1	76.3	0.1163	16.68 36.75
73.025 2.8750	55.562 2.1875	-15.0 -0.59	1.5 0.06	170.9 6.73	170.9 6.73	6.4 0.25	260.4 10.25	251.0 9.88	14.9 0.58	1.7 0.07	556.3	71.8	0.1140	19.35 42.73
93.662 3.6875	61.912 2.4375	-28.2 -1.11	9.7 0.38	177.0 6.97	189.0 7.44	6.9 0.27	274.8 10.82	269.0 10.59	17.8 0.70	-2.7 -0.10	747.4	76.3	0.1176	28.40 62.59
93.662 3.6875	66.675 2.6250	-26.4 -1.04	9.7 0.38	179.1 7.05	191.0 7.52	6.8 0.27	285.5 11.24	276.1 10.87	10.5 0.41	0.8 0.04	718.4	62.1	0.1157	29.12 64.18

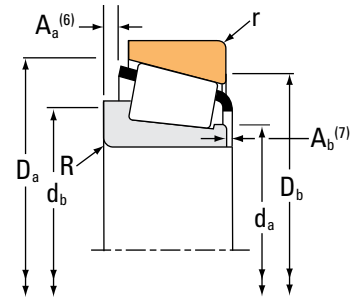
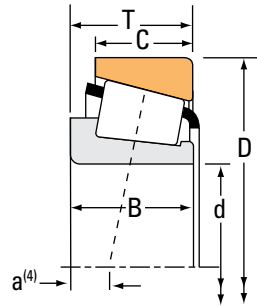
(4) Negative value indicates effective center inside cone (inner-ring) backface.  
 (5) These maximum fillet radii will be cleared by the bearing corners.  
 (6) Negative value indicates cage extends beyond cone (inner-ring) backface.  
 (7) Negative value indicates cage that does not extend beyond cone (inner-ring) front face.  
 (\*) Contact your Timken engineer for details.

Continued on next page.

# TAPERED ROLLER BEARINGS

## SINGLE-ROW • TYPE TS

### TYPE TS



Bearing Dimensions			Load Ratings							Part Number			
Bore d	O.D. D	Width T	Dynamic <sup>(1)</sup>		Factors <sup>(2)</sup>		Dynamic <sup>(3)</sup>		Factors <sup>(2)</sup>		Static C <sub>0</sub>	Inner	Outer
			C <sub>1</sub>	e	Y	C <sub>90</sub>	C <sub>a90</sub>	K	N	N			
mm in.	mm in.	mm in.	N lbf			N lbf	N lbf		N lbf				
152.400 6.0000	307.975 12.1250	88.900 3.5000	1150000 259000	0.33	1.84	299000 67200	167000 37500	1.79	1580000 354000			HH234048	HH234010
152.400 6.0000	317.500 12.5000	88.900 3.5000	1220000 274000	0.33	1.84	316000 71100	177000 39700	1.79	1580000 354000			HH234049	HH234018
155.575 6.1250	330.200 13.0000	85.725 3.3750	1230000 276000	0.81	0.74	319000 71600	441000 99200	0.72	1400000 316000			H936340	H936310
155.575 6.1250	336.550 13.2500	85.725 3.3750	1230000 276000	0.81	0.74	319000 71600	441000 99200	0.72	1400000 316000			H936340	H936313
155.575 6.1250	342.900 13.5000	85.725 3.3750	1230000 276000	0.81	0.74	319000 71600	441000 99200	0.72	1400000 316000			H936340	H936316
158.750 6.2500	205.583 8.0938	23.812 0.9375	147000 33000	0.37	1.61	38100 8560	24300 5470	1.57	280000 63000			L432348	L432310
158.750 6.2500	225.425 8.8750	41.275 1.6250	303000 68200	0.38	1.57	78600 17700	51600 11600	1.52	635000 143000			46780	46720
158.750 6.2500	285.750 11.2500	76.200 3.0000	715000 161000	0.40	1.49	185000 41700	128000 28700	1.45	1060000 237000			EE217062X	217112
158.750 6.2500	304.800 12.0000	66.675 2.6250	603000 136000	0.36	1.67	156000 35100	96400 21700	1.62	867000 195000			EE280626	281200
159.950 6.2973	244.475 9.6250	47.625 1.8750	402000 90300	0.35	1.71	104000 23400	62700 14100	1.66	595000 134000			81629	81962
159.950 6.2973	244.475 9.6250	47.625 1.8750	402000 90300	0.35	1.71	104000 23400	62700 14100	1.66	595000 134000			81630	81962
160.000 6.2992	240.000 9.4488	46.000 1.8110	401000 90200	0.44	1.37	104000 23400	77900 17500	1.34	759000 171000			JM734445	JM734410
160.325 6.3120	288.925 11.3750	63.500 2.5000	976000 219000	0.32	1.88	253000 56900	138000 31100	1.83	1240000 278000			HM237532	HM237510
165.100 6.5000	215.900 8.5000	26.195 1.0313	179000 40200	0.36	1.65	46300 10400	28900 6500	1.60	335000 75300			L433749	L433710
165.100 6.5000	225.425 8.8750	41.275 1.6250	303000 68200	0.38	1.57	78600 17700	51600 11600	1.52	635000 143000			46790	46720
165.100 6.5000	225.425 8.8750	41.275 1.6250	303000 68200	0.38	1.57	78600 17700	51600 11600	1.52	635000 143000			46790A	46720
165.100 6.5000	247.650 9.7500	47.625 1.8750	405000 91100	0.44	1.36	105000 23600	79000 17800	1.33	779000 175000			67780	67720

<sup>(1)</sup>Based on 1 x 10<sup>6</sup> revolutions L<sub>10</sub> life, for the ISO life-calculation method.

<sup>(2)</sup>Consult your Timken engineer for instructions on use or review the Timken Engineering Manual on timken.com/catalogs.

<sup>(3)</sup>Based on 90 x 10<sup>6</sup> revolutions L<sub>10</sub> life, for The Timken Company life-calculation method. C<sub>90</sub> and C<sub>a90</sub> are radial and thrust values.



Bearing Dimensions											Geometry Factors			Bearing Weight
Width B	Width C	Eff. Ctr. a <sup>(4)</sup>	Shaft			Housing			Cage		G <sub>1</sub>	G <sub>2</sub>	C <sub>g</sub>	
			Max Shaft Fillet Radius R <sup>(5)</sup>	Backing Shoulder Dia. d <sub>a</sub>	mm in.	Max Housing Fillet Radius r <sup>(5)</sup>	Backing Shoulder Dia. D <sub>a</sub>	mm in.	A <sub>a</sub> <sup>(6)</sup>	A <sub>b</sub> <sup>(7)</sup>				
mm in.	mm in.	mm in.	mm in.	mm in.	mm in.	mm in.	mm in.	mm in.	mm in.	mm in.			kg lbs.	
93.662 3.6875	66.675 2.6250	-26.4 -1.04	9.7 0.38	179.0 7.05	191.0 7.52	6.8 0.27	285.5 11.24	276.1 10.87	12.5 0.49	-0.8 -0.03	718.4	62.1	0.1157	28.98 63.88
93.662 3.6875	66.675 2.6250	-26.4 -1.04	9.7 0.38	179.1 7.05	191.0 7.52	6.8 0.27	285.5 11.24	279.9 11.02	10.5 0.41	0.8 0.04	718.4	62.1	0.1157	31.42 69.26
79.375 3.1250	53.975 2.1250	16.8 0.66	6.4 0.25	192.4 7.58	209.0 8.23	6.4 0.25	311.4 12.26	282.0 11.10	18.4 0.72	9.2 0.37	637.7	69.1	0.1475	31.74 69.97
79.375 3.1250	53.975 2.1250	16.8 0.66	6.4 0.25	192.4 7.58	209.0 8.23	6.4 0.25	311.0 12.24	285.0 11.22	18.4 0.72	9.2 0.37	637.7	69.1	0.1475	33.15 73.07
79.375 3.1250	53.975 2.1250	16.8 0.66	6.4 0.25	192.4 7.58	209.0 8.23	6.4 0.25	311.4 12.26	287.0 11.30	18.4 0.72	9.2 0.37	637.7	69.1	0.1475	34.46 75.96
23.812 0.9375	18.258 0.7188	9.4 0.37	4.8 0.19	166.0 6.54	174.0 6.85	1.5 0.06	199.0 7.83	195.0 7.68	2.0 0.08	1.2 0.05	319.5	177.3	0.1683	1.86 4.10
39.688 1.5625	33.338 1.3125	2.5 0.10	3.5 0.14	169.0 6.65	176.0 6.93	3.3 0.13	218.0 8.58	209.0 8.23	3.9 0.15	2.0 0.08	572.0	174.7	0.1432	5.15 11.37
73.025 2.8750	55.562 2.1875	-15.0 -0.59	13.5 0.53	176.0 6.93	200.0 7.87	6.4 0.25	260.4 10.25	251.0 9.88	14.9 0.58	1.7 0.07	556.3	71.8	0.1140	18.42 40.61
69.106 2.7207	42.862 1.6875	-12.2 -0.48	6.4 0.25	180.0 7.09	192.0 7.56	3.3 0.13	282.5 11.12	279.0 10.98	15.1 0.59	0.9 0.04	591.3	86.0	0.1115	19.79 43.62
50.005 1.9687	33.338 1.3125	-5.3 -0.21	3.5 0.14	165.0 6.50	176.0 6.93	3.3 0.13	229.1 9.02	225.0 8.86	8.2 0.32	0.0 0.00	413.0	98.4	0.1250	7.06 15.56
46.830 1.8437	33.338 1.3125	-5.3 -0.21	3.5 0.14	170.9 6.73	176.0 6.93	3.3 0.13	229.1 9.02	225.0 8.86	8.2 0.32	3.1 0.13	413.0	98.4	0.1250	6.92 15.25
44.500 1.7520	37.000 1.4567	5.1 0.20	3.0 0.12	173.0 6.81	178.0 7.01	2.5 0.10	232.0 9.13	222.0 8.74	2.6 0.10	4.1 0.16	548.5	117.5	0.1164	7.14 15.73
63.500 2.5000	47.625 1.8750	-11.7 -0.46	7.0 0.28	181.0 7.13	192.0 7.56	3.3 0.13	271.3 10.68	266.0 10.47	5.8 0.23	4.1 0.16	751.2	101.5	0.1168	17.47 38.53
26.195 1.0313	20.638 0.8125	8.6 0.34	1.5 0.06	172.0 6.77	174.0 6.85	1.5 0.06	209.0 8.23	205.0 8.07	2.4 0.09	1.5 0.06	365.1	168.0	0.1748	2.36 5.19
39.688 1.5625	33.338 1.3125	2.5 0.10	3.5 0.14	174.0 6.85	181.0 7.13	3.3 0.13	218.0 8.58	209.0 8.23	3.9 0.15	2.0 0.08	572.0	174.7	0.1432	4.64 10.23
39.688 1.5625	33.338 1.3125	2.5 0.10	8.0 0.31	174.0 6.85	189.0 7.44	3.3 0.13	218.0 8.58	209.0 8.23	3.9 0.15	2.0 0.08	572.0	174.7	0.1432	4.53 10.00
47.625 1.8750	38.100 1.5000	4.8 0.19	3.5 0.14	179.0 7.05	185.0 7.28	3.3 0.13	240.0 9.45	229.0 9.02	4.8 0.19	1.8 0.07	622.3	122.6	0.1214	7.96 17.56

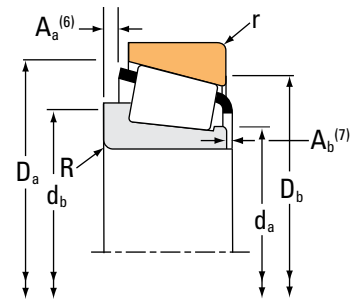
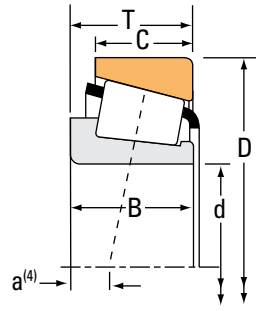
(4) Negative value indicates effective center inside cone (inner-ring) backface.  
 (5) These maximum fillet radii will be cleared by the bearing corners.  
 (6) Negative value indicates cage extends beyond cone (inner-ring) backface.  
 (7) Negative value indicates cage that does not extend beyond cone (inner-ring) front face.

Continued on next page.

# TAPERED ROLLER BEARINGS

## SINGLE-ROW • TYPE TS

### TYPE TS



Bearing Dimensions			Load Ratings							Part Number		
Bore d	O.D. D	Width T	Dynamic <sup>(1)</sup>		Factors <sup>(2)</sup>		Dynamic <sup>(3)</sup>		Factors <sup>(2)</sup>	Static	Inner	Outer
			C <sub>1</sub>	e	Y	C <sub>90</sub>	C <sub>a90</sub>	K	C <sub>0</sub>			
mm in.	mm in.	mm in.	N lbf			N lbf	N lbf			N lbf		
165.100 6.5000	254.000 10.0000	46.038 1.8125	498000 112000	0.37	1.62	129000 29000	81600 18300	1.58		644000 145000	86650	86100
165.100 6.5000	288.925 11.3750	63.500 2.5000	660000 148000	0.47	1.28	171000 38500	137000 30800	1.25		1070000 242000	94649	94113
165.100 6.5000	288.925 11.3750	63.500 2.5000	976000 219000	0.32	1.88	253000 56900	138000 31100	1.83		1240000 278000	HM237535	HM237510
165.100 6.5000	288.925 11.3750	63.500 2.5000	976000 219000	0.32	1.88	253000 56900	138000 31100	1.83		1240000 278000	HM237536	HM237510
165.100 6.5000	298.450 11.7500	82.550 3.2500	927000 208000	0.38	1.59	240000 54000	155000 34900	1.55		1520000 341000	EE219065	219117
165.100 6.5000	311.150 12.2500	82.550 3.2500	927000 208000	0.38	1.59	240000 54000	155000 34900	1.55		1520000 341000	EE219065	219122
165.100 6.5000	311.150 12.2500	82.550 3.2500	1060000 238000	0.33	1.81	274000 61600	155000 34900	1.77		1680000 378000	H238140	H238110
165.100 6.5000	336.550 13.2500	92.075 3.6250	1660000 372000	0.37	1.62	429000 96500	273000 61400	1.57		1930000 434000	HH437549	HH437510
165.100 6.5000	361.950 14.2500	106.362 4.1875	1450000 325000	0.33	1.79	375000 84200	215000 48300	1.74		1950000 439000	EE108065	108142
165.100 6.5000	365.049 14.3720	92.075 3.6250	1170000 263000	0.40	1.49	303000 68100	208000 46800	1.45		1820000 409000	EE420651	421437
166.688 6.5625	225.425 8.8750	41.275 1.6250	303000 68200	0.38	1.57	78600 17700	51600 11600	1.52		635000 143000	46792	46720
168.275 6.6250	247.650 9.7500	47.625 1.8750	405000 91100	0.44	1.36	105000 23600	79000 17800	1.33		779000 175000	67782	67720
168.275 6.6250	330.200 13.0000	85.725 3.3750	1230000 276000	0.81	0.74	319000 71600	441000 99200	0.72		1400000 316000	H936349	H936310
168.275 6.6250	342.900 13.5000	85.725 3.3750	1230000 276000	0.81	0.74	319000 71600	441000 99200	0.72		1400000 316000	H936349	H936316
170.000 6.6929	230.000 9.0551	39.000 1.5354	316000 71100	0.38	1.57	82000 18400	53800 12100	1.52		590000 133000	JHM534149	JHM534110
170.000 6.6929	240.000 9.4488	46.000 1.8110	401000 90200	0.44	1.37	104000 23400	77900 17500	1.34		759000 171000	JM734449	JM734410
170.000 6.6929	254.000 10.0000	46.038 1.8125	498000 112000	0.37	1.62	129000 29000	81600 18300	1.58		644000 145000	86669	86100

<sup>(1)</sup>Based on  $1 \times 10^6$  revolutions  $L_{10}$  life, for the ISO life-calculation method.

<sup>(2)</sup>Consult your Timken engineer for instructions on use or review the Timken Engineering Manual on [timken.com/catalogs](http://timken.com/catalogs).

<sup>(3)</sup>Based on  $90 \times 10^6$  revolutions  $L_{10}$  life, for The Timken Company life-calculation method.  $C_{90}$  and  $C_{a90}$  are radial and thrust values.

Bearing Dimensions											Geometry Factors			Bearing Weight
Width B	Width C	Eff. Ctr. a <sup>(4)</sup>	Shaft			Housing			Cage		G <sub>1</sub>	G <sub>2</sub>	C <sub>g</sub>	
			Max Shaft Fillet Radius R <sup>(5)</sup>	Backing Shoulder Dia. d <sub>a</sub>	Backing Shoulder Dia. d <sub>b</sub>	Max Housing Fillet Radius r <sup>(5)</sup>	Backing Shoulder Dia. D <sub>a</sub>	Backing Shoulder Dia. D <sub>b</sub>	A <sub>a</sub> <sup>(6)</sup>	A <sub>b</sub> <sup>(7)</sup>				
mm in.	mm in.	mm in.	mm in.	mm in.	mm in.	mm in.	mm in.	mm in.	mm in.	mm in.				kg lbs.
46.038 1.8125	33.338 1.3125	-1.5 -0.06	4.8 0.19	176.0 6.93	185.0 7.28	3.3 0.13	239.0 9.41	234.0 9.21	6.8 0.27	2.0 0.08	466.3	111.9	0.1041	7.58 16.72
63.500 2.5000	47.625 1.8750	-0.8 -0.03	7.0 0.28	186.0 7.32	197.0 7.76	3.3 0.13	272.0 10.71	259.0 10.20	6.8 0.26	5.3 0.21	692.3	93.9	0.1287	17.11 37.71
63.500 2.5000	47.625 1.8750	-11.7 -0.46	7.0 0.28	184.0 7.24	195.0 7.68	3.3 0.13	271.3 10.68	266.0 10.47	5.8 0.23	4.1 0.16	751.2	101.5	0.1168	16.86 37.18
63.500 2.5000	47.625 1.8750	-11.7 -0.46	7.0 0.28	187.0 7.36	195.0 7.68	3.3 0.13	271.3 10.68	266.0 10.47	5.8 0.23	4.1 0.16	751.2	101.5	0.1168	16.78 37.01
82.550 3.2500	63.500 2.5000	-15.2 -0.60	6.4 0.25	185.0 7.28	196.0 7.72	6.4 0.25	282.0 11.10	269.0 10.59	9.9 0.39	0.3 0.01	841.4	94.9	0.1286	23.83 52.54
82.550 3.2500	63.500 2.5000	-15.2 -0.60	6.4 0.25	185.0 7.28	196.0 7.72	6.4 0.25	282.0 11.10	275.0 10.83	9.9 0.39	0.3 0.01	841.4	94.9	0.1286	26.95 59.41
82.550 3.2500	65.088 2.5625	-18.5 -0.73	6.4 0.25	188.0 7.40	198.0 7.80	6.4 0.25	289.0 11.36	280.0 11.02	8.2 0.32	2.2 0.09	913.6	92.2	0.1265	27.34 60.28
95.250 3.7500	69.850 2.7500	-21.3 -0.84	3.3 0.13	196.0 7.72	196.0 7.72	6.4 0.25	307.7 12.12	297.0 11.69	11.7 0.46	1.0 0.04	909.5	75.1	0.1310	37.31 82.25
104.775 4.1250	76.200 3.0000	-32.8 -1.29	13.5 0.53	194.0 7.64	215.0 8.46	3.3 0.13	328.9 12.95	323.0 12.72	16.8 0.66	5.6 0.22	941.7	71.4	0.1274	49.11 108.30
88.897 3.4999	63.500 2.5000	-15.5 -0.61	9.7 0.38	199.0 7.83	215.0 8.46	3.3 0.13	334.4 13.16	329.0 12.95	19.1 0.75	2.5 0.10	1150.5	128.2	0.1450	44.51 98.14
39.688 1.5625	33.338 1.3125	2.5 0.10	3.5 0.14	175.0 6.89	182.0 7.17	3.3 0.13	218.0 8.58	209.0 8.23	3.9 0.15	2.0 0.08	572.0	174.7	0.1432	4.53 9.98
47.625 1.8750	38.100 1.5000	4.8 0.19	3.5 0.14	181.0 7.13	187.0 7.36	3.3 0.13	240.0 9.45	229.0 9.02	4.8 0.19	1.8 0.07	622.3	122.6	0.1214	7.65 16.88
79.375 3.1250	53.975 2.1250	16.8 0.66	6.4 0.25	192.4 7.58	218.0 8.58	6.4 0.25	311.4 12.26	282.0 11.10	18.4 0.72	9.2 0.37	637.7	69.1	0.1475	29.73 65.53
79.375 3.1250	53.975 2.1250	16.8 0.66	6.4 0.25	192.4 7.58	218.0 8.58	6.4 0.25	311.4 12.26	287.0 11.30	18.4 0.72	9.2 0.37	637.7	69.1	0.1475	32.45 71.53
38.000 1.4961	31.000 1.2205	4.6 0.18	3.0 0.12	178.0 7.01	184.0 7.24	2.5 0.10	224.0 8.82	217.0 8.54	1.0 0.04	3.4 0.14	479.6	89.8	0.1350	4.30 9.46
44.500 1.7520	37.000 1.4567	5.1 0.20	3.0 0.12	180.0 7.09	185.0 7.28	2.5 0.10	232.0 9.13	222.0 8.74	2.6 0.10	4.1 0.16	548.5	117.5	0.1164	6.25 13.76
46.038 1.8125	33.338 1.3125	-1.5 -0.06	4.8 0.19	180.0 7.09	189.0 7.44	3.3 0.13	239.0 9.41	234.0 9.21	6.8 0.27	2.0 0.08	466.3	111.9	0.1041	7.12 15.69

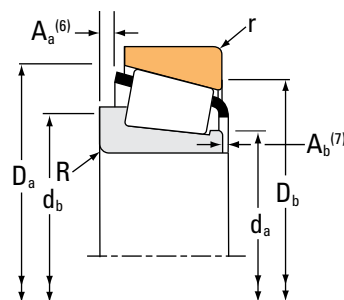
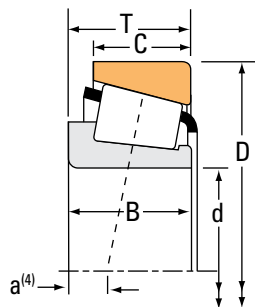
<sup>(4)</sup>Negative value indicates effective center inside cone (inner-ring) backface.  
<sup>(5)</sup>These maximum fillet radii will be cleared by the bearing corners.  
<sup>(6)</sup>Negative value indicates cage extends beyond cone (inner-ring) backface.  
<sup>(7)</sup>Negative value indicates cage that does not extend beyond cone (inner-ring) front face.

Continued on next page.

# TAPERED ROLLER BEARINGS

## SINGLE-ROW • TYPE TS

### TYPE TS



Bearing Dimensions			Load Ratings							Part Number		
Bore d	O.D. D	Width T	Dynamic <sup>(1)</sup>		Factors <sup>(2)</sup>		Dynamic <sup>(3)</sup>		Factors <sup>(2)</sup>	Static	Inner	Outer
			C <sub>1</sub>	e	Y	C <sub>90</sub>	C <sub>a90</sub>	K	C <sub>0</sub>			
mm in.	mm in.	mm in.	N lbf			N lbf	N lbf			N lbf		
170.000 6.6929	254.000 10.0000	46.038 1.8125	513000 115000	0.32	1.88	133000 29900	72600 16300	1.83		740000 166000	M235149	M235113
171.450 6.7500	260.350 10.2500	66.675 2.6250	654000 147000	0.40	1.49	169000 38100	117000 26200	1.45		1180000 265000	HM535349	HM535310
174.625 6.8750	247.650 9.7500	47.625 1.8750	405000 91100	0.44	1.36	105000 23600	79000 17800	1.33		779000 175000	67787	67720
174.625 6.8750	247.650 9.7500	47.625 1.8750	405000 91100	0.44	1.36	105000 23600	79000 17800	1.33		779000 175000	67786	67720
174.625 6.8750	260.350 10.2500	53.975 2.1250	537000 121000	0.33	1.80	139000 31300	79200 17800	1.76		933000 210000	M236845	M236810
174.625 6.8750	288.925 11.3750	63.500 2.5000	660000 148000	0.47	1.28	171000 38500	137000 30800	1.25		1070000 242000	94687	94113
174.625 6.8750	298.450 11.7500	82.550 3.2500	927000 208000	0.38	1.59	240000 54000	155000 34900	1.55		1520000 341000	EE219068	219117
174.625 6.8750	311.150 12.2500	82.550 3.2500	927000 208000	0.38	1.59	240000 54000	155000 34900	1.55		1520000 341000	EE219068	219122
174.625 6.8750	311.150 12.2500	82.550 3.2500	1120000 252000	0.33	1.81	290000 65200	164000 36900	1.77		1680000 378000	H238148	H238110
177.800 7.0000	215.900 8.5000	20.638 0.8125	122000 27500	0.45	1.33	31700 7130	24500 5500	1.30		252000 56600	LL735449	LL735410
177.800 7.0000	247.650 9.7500	47.625 1.8750	405000 91100	0.44	1.36	105000 23600	79000 17800	1.33		779000 175000	67790	67720
177.800 7.0000	247.650 9.7500	47.625 1.8750	405000 91100	0.44	1.36	105000 23600	79000 17800	1.33		779000 175000	67791	67720
177.800 7.0000	260.350 10.2500	53.975 2.1250	537000 121000	0.33	1.80	139000 31300	79200 17800	1.76		933000 210000	M236849	M236810
177.800 7.0000	260.350 10.2500	53.975 2.1250	537000 121000	0.33	1.80	139000 31300	79200 17800	1.76		933000 210000	M236848	M236810
177.800 7.0000	269.875 10.6250	55.562 2.1875	508000 114000	0.33	1.80	132000 29600	74900 16800	1.76		999000 225000	M238840	M238810
177.800 7.0000	288.925 11.3750	63.500 2.5000	660000 148000	0.47	1.28	171000 38500	137000 30800	1.25		1070000 242000	94700	94113
177.800 7.0000	288.925 11.3750	63.500 2.5000	976000 219000	0.32	1.88	253000 56900	138000 31100	1.83		1240000 278000	HM237545	HM237510

<sup>(1)</sup>Based on 1 x 10<sup>6</sup> revolutions L<sub>10</sub> life, for the ISO life-calculation method.

<sup>(2)</sup>Consult your Timken engineer for instructions on use or review the Timken Engineering Manual on timken.com/catalogs.

<sup>(3)</sup>Based on 90 x 10<sup>6</sup> revolutions L<sub>10</sub> life, for The Timken Company life-calculation method. C<sub>90</sub> and C<sub>a90</sub> are radial and thrust values.

Bearing Dimensions											Geometry Factors			Bearing Weight
Width B	Width C	Eff. Ctr. a <sup>(4)</sup>	Shaft			Housing			Cage		G <sub>1</sub>	G <sub>2</sub>	C <sub>g</sub>	
			Max Shaft Fillet Radius R <sup>(5)</sup>	Backing Shoulder Dia. d <sub>a</sub>	Backing Shoulder Dia. d <sub>b</sub>	Max Housing Fillet Radius r <sup>(5)</sup>	Backing Shoulder Dia. D <sub>a</sub>	Backing Shoulder Dia. D <sub>b</sub>	A <sub>a</sub> <sup>(6)</sup>	A <sub>b</sub> <sup>(7)</sup>				
mm in.	mm in.	mm in.	mm in.	mm in.	mm in.	mm in.	mm in.	mm in.	mm in.	mm in.				kg lbs.
46.038 1.8125	33.338 1.3125	-4.6 -0.18	4.8 0.19	182.0 7.17	189.0 7.44	3.3 0.13	240.0 9.45	235.0 9.25	4.8 0.19	3.0 0.12	531.4	107.5	0.1037	7.33 16.14
66.675 2.6250	52.388 2.0625	-8.6 -0.34	3.5 0.14	186.1 7.40	192.0 7.56	3.3 0.13	250.0 9.84	236.0 9.29	6.0 0.23	2.2 0.09	749.5	115.6	0.1263	12.20 26.90
47.625 1.8750	38.100 1.5000	4.8 0.19	3.5 0.14	185.0 7.28	192.0 7.56	3.3 0.13	240.0 9.45	229.0 9.02	4.8 0.19	1.8 0.07	622.3	122.6	0.1214	7.01 15.47
47.625 1.8750	38.100 1.5000	4.8 0.19	8.0 0.31	185.0 7.28	200.0 7.87	3.3 0.13	240.0 9.45	229.0 9.02	4.8 0.19	1.8 0.07	622.3	122.6	0.1214	6.97 15.37
53.975 2.1250	41.275 1.6250	-6.6 -0.26	3.5 0.14	189.0 7.44	193.0 7.60	3.3 0.13	249.0 9.80	241.0 9.49	4.6 0.18	3.3 0.13	690.9	100.2	0.1150	9.46 20.84
63.500 2.5000	47.625 1.8750	-0.8 -0.03	7.0 0.28	193.0 7.60	204.0 8.03	3.3 0.13	272.0 10.71	259.0 10.20	6.8 0.26	5.3 0.21	692.3	93.9	0.1287	15.78 34.77
82.550 3.2500	63.500 2.5000	-15.2 -0.60	6.4 0.25	193.0 7.60	204.0 8.03	6.4 0.25	282.0 11.10	269.0 10.59	9.9 0.39	0.3 0.01	841.4	94.9	0.1286	22.18 48.91
82.550 3.2500	63.500 2.5000	-15.2 -0.60	6.4 0.25	193.0 7.60	204.0 8.03	6.4 0.25	282.0 11.10	275.0 10.83	9.9 0.39	0.3 0.01	841.4	94.9	0.1286	25.30 55.78
82.550 3.2500	65.088 2.5625	-18.5 -0.73	6.4 0.25	195.0 7.68	205.0 8.07	6.4 0.25	289.0 11.36	280.0 11.02	8.2 0.32	2.2 0.09	913.6	92.2	0.1265	25.70 56.66
20.638 0.8125	15.083 0.5938	17.8 0.70	1.5 0.06	184.0 7.24	186.0 7.32	1.5 0.06	212.0 8.35	207.0 8.15	1.2 0.05	1.6 0.07	345.8	240.8	0.1825	1.43 3.14
47.625 1.8750	38.100 1.5000	4.8 0.19	3.5 0.14	188.0 7.40	194.0 7.64	3.3 0.13	240.0 9.45	229.0 9.02	4.8 0.19	1.8 0.07	622.3	122.6	0.1214	6.69 14.75
47.625 1.8750	38.100 1.5000	4.8 0.19	10.5 0.41	188.0 7.40	208.0 8.19	3.3 0.13	240.0 9.45	229.0 9.02	4.8 0.19	1.8 0.07	622.3	122.6	0.1214	6.59 14.54
53.975 2.1250	41.275 1.6250	-6.6 -0.26	3.5 0.14	191.0 7.52	195.0 7.68	3.3 0.13	249.0 9.80	241.0 9.49	4.6 0.18	3.3 0.13	690.9	100.2	0.1150	9.10 20.06
53.975 2.1250	41.275 1.6250	-6.6 -0.26	8.0 0.31	191.0 7.52	204.0 8.03	3.3 0.13	249.0 9.80	241.0 9.49	4.6 0.18	3.3 0.13	690.9	100.2	0.1150	9.06 19.96
55.562 2.1875	42.862 1.6875	-6.1 -0.24	3.5 0.14	194.0 7.64	198.0 7.80	3.3 0.13	256.0 10.08	250.0 9.84	5.8 0.23	2.1 0.09	788.3	118.1	0.1201	11.00 24.26
63.500 2.5000	47.625 1.8750	-0.8 -0.03	7.0 0.28	195.0 7.68	207.0 8.15	3.3 0.13	272.0 10.71	259.0 10.20	6.8 0.26	5.3 0.21	692.3	93.9	0.1287	15.40 33.95
63.500 2.5000	47.625 1.8750	-11.7 -0.46	7.0 0.28	194.0 7.64	205.0 8.07	3.3 0.13	271.3 10.68	266.0 10.47	5.8 0.23	4.1 0.16	751.2	101.5	0.1168	15.15 33.43

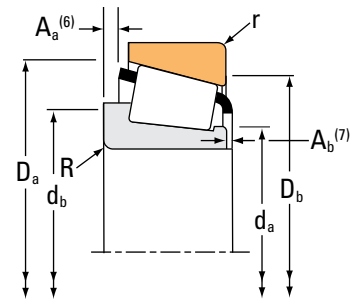
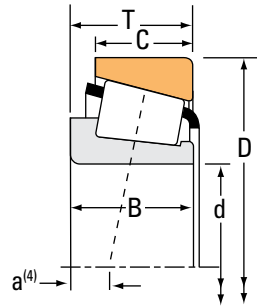
<sup>(4)</sup>Negative value indicates effective center inside cone (inner-ring) backface.  
<sup>(5)</sup>These maximum fillet radii will be cleared by the bearing corners.  
<sup>(6)</sup>Negative value indicates cage extends beyond cone (inner-ring) backface.  
<sup>(7)</sup>Negative value indicates cage that does not extend beyond cone (inner-ring) front face.

Continued on next page.

# TAPERED ROLLER BEARINGS

## SINGLE-ROW • TYPE TS

### TYPE TS



Bearing Dimensions			Load Ratings							Part Number			
Bore d	O.D. D	Width T	Dynamic <sup>(1)</sup>		Factors <sup>(2)</sup>		Dynamic <sup>(3)</sup>		Factors <sup>(2)</sup>		Static C <sub>0</sub>	Inner	Outer
			C <sub>1</sub>	e	Y	C <sub>90</sub>	C <sub>a90</sub>	K	N	N			
mm in.	mm in.	mm in.	N lbf			N lbf	N lbf		N lbf				
177.800 7.0000	298.450 11.7500	63.500 2.5000	660000 148000	0.47	1.28	171000 38500	137000 30800	1.25	1070000 242000			94700	94118
177.800 7.0000	319.964 12.5970	88.900 3.5000	1050000 236000	0.32	1.88	272000 61100	148000 33400	1.83	1580000 356000			H239640	H239610
177.800 7.0000	320.675 12.6250	88.900 3.5000	1050000 236000	0.32	1.88	272000 61100	148000 33400	1.83	1580000 356000			H239640	H239612
177.800 7.0000	327.025 12.8750	90.488 3.5625	1020000 229000	0.37	1.64	264000 59200	165000 37100	1.60	1580000 354000			EE470078X	470128
177.800 7.0000	330.200 13.0000	90.488 3.5625	1020000 229000	0.37	1.64	264000 59200	165000 37100	1.60	1580000 354000			EE470078X	470130
177.800 7.0000	330.200 13.0000	90.488 3.5625	1020000 229000	0.37	1.64	264000 59200	165000 37100	1.60	1580000 354000			EE470073	470130
177.800 7.0000	336.550 13.2500	90.488 3.5625	1020000 229000	0.37	1.64	264000 59200	165000 37100	1.60	1580000 354000			EE470073	470132
177.800 7.0000	355.600 14.0000	61.912 2.4375	876000 197000	0.40	1.50	227000 51100	155000 34900	1.46	1080000 243000			EE780705	781400
177.800 7.0000	360.000 14.1732	92.075 3.6250	1170000 263000	0.40	1.49	303000 68100	208000 46800	1.45	1820000 409000			EE420701	421417
177.800 7.0000	365.049 14.3720	92.075 3.6250	1170000 263000	0.40	1.49	303000 68100	208000 46800	1.45	1820000 409000			EE420701	421437
177.800 7.0000	368.300 14.5000	92.075 3.6250	1170000 263000	0.40	1.49	303000 68100	208000 46800	1.45	1820000 409000			EE420701	421450
177.800 7.0000	428.625 16.8750	106.362 4.1875	1500000 338000	0.76	0.79	390000 87600	506000 114000	0.77	1700000 382000			EE350701	351687
179.975 7.0856	317.500 12.5000	63.500 2.5000	731000 164000	0.52	1.15	190000 42600	170000 38200	1.12	1290000 290000			93708	93125
180.000 7.0866	250.000 9.8425	47.000 1.8504	409000 92000	0.48	1.25	106000 23800	87200 19600	1.22	786000 177000			JM736149	JM736110
180.000 7.0866	250.000 9.8425	47.000 1.8504	409000 92000	0.48	1.25	106000 23800	87200 19600	1.22	786000 177000			JM736149A	JM736110
184.150 7.2500	234.950 9.2500	34.000 1.3386	284000 63800	0.33	1.79	73600 16500	42200 9480	1.74	550000 124000			LM236749	LM236710
184.150 7.2500	235.229 9.2610	34.000 1.3386	284000 63800	0.33	1.79	73600 16500	42200 9480	1.74	550000 124000			LM236749	LM236710A

<sup>(1)</sup>Based on 1 x 10<sup>6</sup> revolutions L<sub>10</sub> life, for the ISO life-calculation method.

<sup>(2)</sup>Consult your Timken engineer for instructions on use or review the Timken Engineering Manual on timken.com/catalogs.

<sup>(3)</sup>Based on 90 x 10<sup>6</sup> revolutions L<sub>10</sub> life, for The Timken Company life-calculation method. C<sub>90</sub> and C<sub>a90</sub> are radial and thrust values.

Bearing Dimensions											Geometry Factors			Bearing Weight
Width B	Width C	Eff. Ctr. a <sup>(4)</sup>	Shaft			Housing			Cage		G <sub>1</sub>	G <sub>2</sub>	C <sub>g</sub>	
			Max Shaft Fillet Radius R <sup>(5)</sup>	Backing Shoulder Dia. d <sub>a</sub>	Shoulder Dia. d <sub>b</sub>	Max Housing Fillet Radius r <sup>(5)</sup>	Backing Shoulder Dia. D <sub>a</sub>	Shoulder Dia. D <sub>b</sub>	A <sub>a</sub> <sup>(6)</sup>	A <sub>b</sub> <sup>(7)</sup>				
mm in.	mm in.	mm in.	mm in.	mm in.	mm in.	mm in.	mm in.	mm in.	mm in.	mm in.				kg lbs.
63.500 2.5000	47.625 1.8750	-0.8 -0.03	7.0 0.28	195.0 7.68	207.0 8.15	3.3 0.13	272.0 10.71	263.0 10.35	6.8 0.26	5.3 0.21	692.3	93.9	0.1287	17.00 37.48
85.725 3.3750	65.088 2.5625	-22.4 -0.88	3.5 0.14	198.0 7.80	202.0 7.95	4.8 0.19	301.0 11.84	293.0 11.54	11.5 0.45	2.8 0.11	905.7	90.3	0.1242	27.68 61.03
85.725 3.3750	65.088 2.5625	-22.4 -0.88	3.5 0.14	198.0 7.80	202.0 7.95	4.8 0.19	301.0 11.84	293.0 11.54	11.5 0.45	2.8 0.11	905.7	90.3	0.1242	27.87 61.44
92.075 3.6250	63.500 2.5000	-21.8 -0.86	9.7 0.38	201.0 7.91	217.0 8.54	6.4 0.25	306.5 12.07	294.0 11.57	* *	* *	914.1	104.7	0.1304	30.42 67.07
92.075 3.6250	63.500 2.5000	-21.8 -0.86	9.7 0.38	201.0 7.91	217.0 8.54	6.4 0.25	306.5 12.07	295.0 11.61	* *	* *	914.1	104.7	0.1304	31.48 69.40
92.075 3.6250	63.500 2.5000	-21.8 -0.86	13.5 0.53	201.0 7.91	225.0 8.86	6.4 0.25	306.5 12.07	295.0 11.61	13.9 0.54	-0.4 -0.01	914.1	104.7	0.1304	31.28 68.95
92.075 3.6250	63.500 2.5000	-21.8 -0.86	13.5 0.53	201.0 7.91	225.0 8.86	6.4 0.25	306.5 12.07	298.0 11.73	13.9 0.54	-0.4 -0.01	914.1	104.7	0.1304	32.93 72.60
60.325 2.3750	41.275 1.6250	-0.3 -0.01	4.8 0.19	209.0 8.23	207.0 8.15	4.8 0.19	321.1 12.64	320.0 12.60	7.7 0.30	5.5 0.22	646.5	79.5	0.1185	25.51 56.23
88.897 3.4999	63.500 2.5000	-15.5 -0.61	12.7 0.50	208.0 8.19	231.0 9.09	3.3 0.13	334.4 13.16	327.0 12.87	19.1 0.75	2.5 0.10	1150.5	128.2	0.1450	40.54 89.37
88.897 3.4999	63.500 2.5000	-15.5 -0.61	12.7 0.50	208.0 8.19	231.0 9.09	3.3 0.13	334.4 13.16	329.0 12.95	19.1 0.75	2.5 0.10	1150.5	128.2	0.1450	41.96 92.51
88.897 3.4999	63.500 2.5000	-15.5 -0.61	12.7 0.50	208.0 8.19	231.0 9.09	3.3 0.13	334.4 13.16	331.0 13.03	19.1 0.75	2.5 0.10	1150.5	128.2	0.1450	42.89 94.56
95.250 3.7500	61.912 2.4375	13.0 0.51	6.4 0.25	221.0 8.70	230.0 9.06	6.4 0.25	383.0 15.08	365.0 14.37	21.1 0.83	16.1 0.64	827.7	77.3	0.1568	65.70 144.84
63.500 2.5000	46.038 1.8125	7.9 0.31	3.5 0.14	204.0 8.03	209.0 8.23	3.3 0.13	300.0 11.81	286.0 11.26	9.1 0.36	4.3 0.17	912.5	126.1	0.1460	21.24 46.84
45.000 1.7717	37.000 1.4567	8.9 0.35	3.0 0.12	190.5 7.50	196.0 7.72	2.5 0.10	242.6 9.55	232.0 9.13	3.3 0.13	4.1 0.16	589.4	128.0	0.1227	6.67 14.70
45.000 1.7717	37.000 1.4567	8.9 0.35	9.5 0.37	190.0 7.48	209.0 8.23	2.5 0.10	242.6 9.55	232.0 9.13	3.3 0.13	4.1 0.16	589.4	128.0	0.1227	6.61 14.58
33.000 1.2992	28.000 1.1024	5.1 0.20	2.0 0.08	191.0 7.52	195.0 7.68	2.0 0.08	229.0 9.02	224.0 8.82	0.4 0.01	3.6 0.15	558.8	173.3	0.1353	3.35 7.37
33.000 1.2992	28.000 1.1024	5.1 0.20	2.0 0.08	191.0 7.52	195.0 7.68	2.0 0.08	229.0 9.02	224.0 8.82	0.4 0.01	3.6 0.15	558.8	173.3	0.1353	3.38 7.45

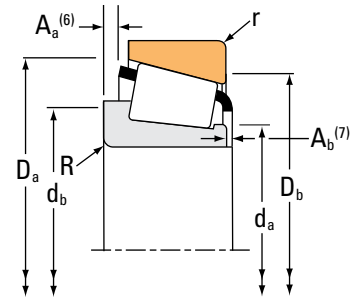
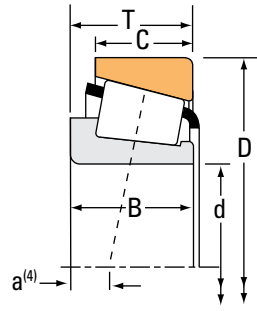
(4) Negative value indicates effective center inside cone (inner-ring) backface.  
 (5) These maximum fillet radii will be cleared by the bearing corners.  
 (6) Negative value indicates cage extends beyond cone (inner-ring) backface.  
 (7) Negative value indicates cage that does not extend beyond cone (inner-ring) front face.  
 (\*) Contact your Timken engineer for details.

Continued on next page.

# TAPERED ROLLER BEARINGS

## SINGLE-ROW • TYPE TS

### TYPE TS



Bearing Dimensions			Load Ratings							Part Number			
Bore d	O.D. D	Width T	Dynamic <sup>(1)</sup>		Factors <sup>(2)</sup>		Dynamic <sup>(3)</sup>		Factors <sup>(2)</sup>		Static C <sub>0</sub>	Inner	Outer
			C <sub>1</sub>	e	Y	C <sub>90</sub>	C <sub>a90</sub>	K	N	N			
mm in.	mm in.	mm in.	N lbf			N lbf	N lbf		N lbf				
184.150 7.2500	236.538 9.3125	26.193 1.0312	174000 39000	0.40	1.49	45000 10100	31000 6960	1.45	337000 75700			LL537649	LL537610
184.150 7.2500	266.700 10.5000	47.625 1.8750	416000 93600	0.48	1.26	108000 24300	88200 19800	1.22	835000 188000			67883	67820
187.325 7.3750	266.700 10.5000	47.625 1.8750	416000 93600	0.48	1.26	108000 24300	88200 19800	1.22	835000 188000			67884	67820
187.325 7.3750	269.875 10.6250	55.562 2.1875	548000 123000	0.33	1.80	142000 32000	80900 18200	1.76	999000 225000			M238849	M238810
187.325 7.3750	282.575 11.1250	50.800 2.0000	509000 114000	0.42	1.44	132000 29700	93900 21100	1.41	692000 156000			87737	87111
187.325 7.3750	320.675 12.6250	88.900 3.5000	1050000 236000	0.32	1.88	272000 61100	148000 33400	1.83	1580000 356000			H239649	H239612
190.000 7.4803	260.000 10.2362	46.000 1.8110	407000 91500	0.48	1.26	105000 23700	86200 19400	1.22	807000 181000			JM738249	JM738210
190.000 7.4803	269.875 10.6250	55.563 2.1875	548000 123000	0.33	1.80	142000 32000	80900 18200	1.76	999000 225000			JM238848	M238810
190.078 7.4834	289.992 11.4170	46.000 1.8110	416000 93600	0.48	1.26	108000 24300	88200 19800	1.22	835000 188000			67886	67835
190.500 7.5000	266.700 10.5000	47.625 1.8750	416000 93600	0.48	1.26	108000 24300	88200 19800	1.22	835000 188000			67885	67820
190.500 7.5000	282.575 11.1250	50.800 2.0000	509000 114000	0.42	1.44	132000 29700	93900 21100	1.41	692000 156000			87750	87111
190.500 7.5000	284.162 11.1875	55.562 2.1875	577000 130000	0.36	1.68	150000 33600	91500 20600	1.63	1060000 239000			82788	82722
190.500 7.5000	288.925 11.3750	55.562 2.1875	577000 130000	0.36	1.68	150000 33600	91500 20600	1.63	1060000 239000			82788	82720
190.500 7.5000	317.500 12.5000	63.500 2.5000	731000 164000	0.52	1.15	190000 42600	170000 38200	1.12	1290000 290000			93750	93125
190.500 7.5000	327.025 12.8750	90.488 3.5625	1020000 229000	0.37	1.64	264000 59200	165000 37100	1.60	1580000 354000			EE470075	470128
190.500 7.5000	330.200 13.0000	63.500 2.5000	678000 152000	0.38	1.56	176000 39500	116000 26000	1.52	1050000 235000			EE210753	211300
190.500 7.5000	336.550 13.2500	90.488 3.5625	1020000 229000	0.37	1.64	264000 59200	165000 37100	1.60	1580000 354000			EE470075	470132

<sup>(1)</sup>Based on 1 x 10<sup>6</sup> revolutions L<sub>10</sub> life, for the ISO life-calculation method.

<sup>(2)</sup>Consult your Timken engineer for instructions on use or review the Timken Engineering Manual on timken.com/catalogs.

<sup>(3)</sup>Based on 90 x 10<sup>6</sup> revolutions L<sub>10</sub> life, for The Timken Company life-calculation method. C<sub>90</sub> and C<sub>a90</sub> are radial and thrust values.



Bearing Dimensions											Geometry Factors			Bearing Weight
Width B	Width C	Eff. Ctr. a <sup>(4)</sup>	Shaft			Housing			Cage		G <sub>1</sub>	G <sub>2</sub>	C <sub>g</sub>	
			Max Shaft Fillet Radius R <sup>(5)</sup>	Backing Shoulder Dia. d <sub>a</sub>	Backing Shoulder Dia. d <sub>b</sub>	Max Housing Fillet Radius r <sup>(5)</sup>	Backing Shoulder Dia. D <sub>a</sub>	Backing Shoulder Dia. D <sub>b</sub>	A <sub>a</sub> <sup>(6)</sup>	A <sub>b</sub> <sup>(7)</sup>				
mm in.	mm in.	mm in.	mm in.	mm in.	mm in.	mm in.	mm in.	mm in.	mm in.	mm in.				kg lbs.
25.400 1.0000	19.050 0.7500	13.7 0.54	1.5 0.06	192.0 7.56	194.0 7.64	1.5 0.06	230.0 9.06	225.0 8.86	3.1 0.12	1.4 0.06	418.3	210.9	0.1293	2.59 5.71
46.833 1.8438	38.100 1.5000	10.2 0.40	3.5 0.14	198.0 7.80	204.0 8.03	3.3 0.13	259.0 10.20	246.0 9.69	5.0 0.20	1.8 0.08	727.9	146.6	0.1310	8.65 19.07
46.833 1.8438	38.100 1.5000	10.2 0.40	3.5 0.14	201.0 7.91	206.0 8.11	3.3 0.13	259.0 10.20	246.0 9.69	5.0 0.20	1.8 0.08	727.9	146.6	0.1310	8.29 18.28
55.562 2.1875	42.862 1.6875	-6.1 -0.24	3.5 0.14	201.0 7.91	205.0 8.07	3.3 0.13	256.0 10.08	250.0 9.84	5.8 0.23	2.1 0.09	788.3	118.1	0.1201	9.82 21.64
47.625 1.8750	36.512 1.4375	3.8 0.15	3.5 0.14	201.0 7.91	207.0 8.15	3.3 0.13	267.0 10.50	261.0 10.28	8.7 0.34	2.7 0.11	574.6	130.8	0.1155	9.82 21.64
85.725 3.3750	65.088 2.5625	-22.4 -0.88	5.5 0.22	205.0 8.07	214.0 8.43	4.8 0.19	301.0 11.84	293.0 11.54	11.5 0.45	2.8 0.11	905.7	90.3	0.1242	26.02 57.35
44.000 1.7323	36.500 1.4370	10.9 0.43	3.0 0.12	200.0 7.87	206.0 8.11	2.5 0.10	252.0 9.92	242.0 9.53	3.2 0.12	4.0 0.16	653.1	146.7	0.1265	6.85 15.09
55.562 2.1875	42.862 1.6875	-6.1 -0.24	3.0 0.12	203.0 7.99	206.0 8.11	3.3 0.13	256.0 10.08	250.0 9.84	5.8 0.23	2.1 0.09	788.3	118.1	0.1201	9.51 20.96
46.000 1.8110	36.000 1.4173	10.7 0.42	6.4 0.25	203.0 7.99	214.0 8.43	3.3 0.13	259.0 10.20	256.0 10.08	4.5 0.18	2.2 0.09	727.9	146.6	0.1310	10.56 23.29
46.833 1.8438	38.100 1.5000	10.2 0.40	3.5 0.14	203.0 7.99	209.0 8.23	3.3 0.13	259.0 10.20	246.0 9.69	5.0 0.20	1.8 0.08	727.9	146.6	0.1310	7.96 17.56
47.625 1.8750	36.512 1.4375	3.8 0.15	3.5 0.14	203.0 7.99	209.0 8.23	3.3 0.13	267.0 10.50	261.0 10.28	8.7 0.34	2.7 0.11	574.6	130.8	0.1155	9.49 20.91
55.562 2.1875	42.862 1.6875	-2.8 -0.11	3.5 0.14	203.0 7.99	210.0 8.27	3.3 0.13	271.0 10.67	263.0 10.35	5.2 0.20	2.3 0.09	804.7	110.8	0.1238	11.55 25.46
55.562 2.1875	42.862 1.6875	-2.8 -0.11	3.5 0.14	203.0 7.99	210.0 8.27	3.3 0.13	271.0 10.67	265.0 10.43	5.2 0.20	2.3 0.09	804.7	110.8	0.1238	12.30 27.11
63.500 2.5000	46.038 1.8125	7.9 0.31	4.3 0.17	212.0 8.35	218.0 8.58	3.3 0.13	300.0 11.81	286.0 11.26	9.1 0.36	4.3 0.17	912.5	126.1	0.1460	19.74 43.52
92.075 3.6250	63.500 2.5000	-21.8 -0.86	6.4 0.25	210.0 8.27	220.0 8.66	6.4 0.25	306.5 12.07	294.0 11.57	* *	* *	914.1	104.7	0.1304	27.89 61.49
61.912 2.4375	42.862 1.6875	-4.6 -0.18	7.0 0.28	210.0 8.27	221.0 8.70	3.3 0.13	300.0 11.81	299.0 11.77	11.6 0.45	4.0 0.16	736.7	115.8	0.1227	19.85 43.75
92.075 3.6250	63.500 2.5000	-21.8 -0.86	6.4 0.25	210.0 8.27	220.0 8.66	6.4 0.25	306.5 12.07	298.0 11.73	* *	* *	914.1	104.7	0.1304	30.60 67.48

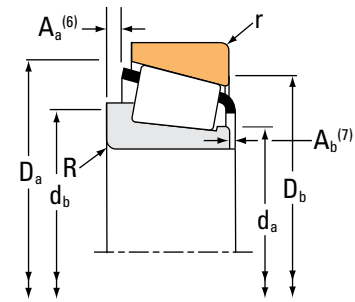
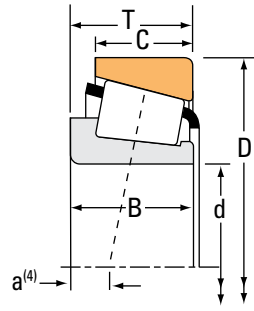
(4) Negative value indicates effective center inside cone (inner-ring) backface.  
 (5) These maximum fillet radii will be cleared by the bearing corners.  
 (6) Negative value indicates cage extends beyond cone (inner-ring) backface.  
 (7) Negative value indicates cage that does not extend beyond cone (inner-ring) front face.  
 (\*) Contact your Timken engineer for details.

Continued on next page.

# TAPERED ROLLER BEARINGS

## SINGLE-ROW • TYPE TS

### TYPE TS



Bearing Dimensions			Load Ratings							Part Number		
Bore d	O.D. D	Width T	Dynamic <sup>(1)</sup>		Factors <sup>(2)</sup>		Dynamic <sup>(3)</sup>		Factors <sup>(2)</sup>	Static	Inner	Outer
			C <sub>1</sub>	e	Y	C <sub>90</sub>	C <sub>a90</sub>	K	C <sub>0</sub>			
mm in.	mm in.	mm in.	N lbf			N lbf	N lbf			N lbf		
190.500 7.5000	336.550 13.2500	98.425 3.8750	1150000 259000	0.58	1.04	299000 67100	294000 66200	1.01		2050000 460000	HH840249	HH840210
190.500 7.5000	360.000 14.1732	92.075 3.6250	1170000 263000	0.40	1.49	303000 68100	208000 46800	1.45		1820000 409000	EE420751	421417
190.500 7.5000	365.049 14.3720	92.075 3.6250	1170000 263000	0.40	1.49	303000 68100	208000 46800	1.45		1820000 409000	EE420751	421437
190.500 7.5000	368.300 14.5000	92.075 3.6250	1170000 263000	0.40	1.49	303000 68100	208000 46800	1.45		1820000 409000	EE420751	421450
190.500 7.5000	428.625 16.8750	106.363 4.1875	1640000 370000	0.76	0.79	426000 95900	554000 124000	0.77		1700000 382000	EE350750	351687
192.088 7.5625	266.700 10.5000	47.625 1.8750	416000 93600	0.48	1.26	108000 24300	88200 19800	1.22		835000 188000	67887	67820
193.675 7.6250	282.575 11.1250	50.800 2.0000	509000 114000	0.42	1.44	132000 29700	93900 21100	1.41		692000 156000	87762	87111
196.850 7.7500	257.175 10.1250	39.688 1.5625	318000 71600	0.45	1.34	82500 18600	63100 14200	1.31		718000 161000	LM739749	LM739710
196.850 7.7500	266.700 10.5000	39.688 1.5625	318000 71600	0.45	1.34	82500 18600	63100 14200	1.31		718000 161000	LM739749	LM739719
196.850 7.7500	317.500 12.5000	63.500 2.5000	731000 164000	0.52	1.15	190000 42600	170000 38200	1.12		1290000 290000	93775	93125
200.000 7.8740	300.000 11.8110	65.000 2.5591	695000 156000	0.52	1.15	180000 40500	161000 36200	1.12		1280000 287000	JHM840449	JHM840410
200.025 7.8750	292.100 11.5000	57.945 2.2813	600000 135000	0.33	1.80	156000 35000	88500 19900	1.76		1170000 263000	M241543	M241510
200.025 7.8750	317.500 12.5000	63.500 2.5000	731000 164000	0.52	1.15	190000 42600	170000 38200	1.12		1290000 290000	93787	93125
200.025 7.8750	317.500 12.5000	68.262 2.6875	731000 164000	0.52	1.15	190000 42600	170000 38200	1.12		1290000 290000	93787	93126
200.025 7.8750	320.000 12.5984	63.500 2.5000	731000 164000	0.52	1.15	190000 42600	170000 38200	1.12		1290000 290000	93787	J93129A
200.025 7.8750	355.600 14.0000	69.850 2.7500	796000 179000	0.33	1.82	206000 46400	117000 26200	1.77		1400000 314000	EE130787	131400
200.025 7.8750	384.175 15.1250	112.712 4.4375	1670000 377000	0.33	1.80	434000 97600	247000 55600	1.76		3110000 699000	H247535	H247510

<sup>(1)</sup>Based on 1 x 10<sup>6</sup> revolutions L<sub>10</sub> life, for the ISO life-calculation method.

<sup>(2)</sup>Consult your Timken engineer for instructions on use or review the Timken Engineering Manual on timken.com/catalogs.

<sup>(3)</sup>Based on 90 x 10<sup>6</sup> revolutions L<sub>10</sub> life, for The Timken Company life-calculation method. C<sub>90</sub> and C<sub>a90</sub> are radial and thrust values.

Bearing Dimensions											Geometry Factors			Bearing Weight
Width B	Width C	Eff. Ctr. a <sup>(4)</sup>	Shaft			Housing			Cage		G <sub>1</sub>	G <sub>2</sub>	C <sub>g</sub>	
			Max Shaft Fillet Radius R <sup>(5)</sup>	Backing Shoulder Dia. d <sub>a</sub>	Backing Shoulder Dia. d <sub>b</sub>	Max Housing Fillet Radius r <sup>(5)</sup>	Backing Shoulder Dia. D <sub>a</sub>	Backing Shoulder Dia. D <sub>b</sub>	A <sub>a</sub> <sup>(6)</sup>	A <sub>b</sub> <sup>(7)</sup>				
mm in.	mm in.	mm in.	mm in.	mm in.	mm in.	mm in.	mm in.	mm in.	mm in.	mm in.				kg lbs.
95.250 3.7500	73.025 2.8750	-5.6 -0.22	6.4 0.25	215.7 8.49	234.0 9.21	6.4 0.25	318.0 12.52	290.0 11.42	14.4 0.56	5.2 0.21	1088.1	104.3	0.1605	35.64 78.56
88.897 3.4999	63.500 2.5000	-15.5 -0.61	6.4 0.25	218.0 8.58	227.0 8.94	3.3 0.13	334.4 13.16	327.0 12.87	19.1 0.75	2.5 0.10	1150.5	128.2	0.1450	38.26 84.34
88.897 3.4999	63.500 2.5000	-15.5 -0.61	6.4 0.25	218.0 8.58	227.0 8.94	3.3 0.13	334.4 13.16	329.0 12.95	19.1 0.75	2.5 0.10	1150.5	128.2	0.1450	39.68 87.48
88.897 3.4999	63.500 2.5000	-15.5 -0.61	6.4 0.25	218.0 8.58	227.0 8.94	3.3 0.13	334.4 13.16	331.0 13.03	19.1 0.75	2.5 0.10	1150.5	128.2	0.1450	40.61 89.53
95.250 3.7500	61.912 2.4375	13.0 0.51	6.4 0.25	237.0 9.33	240.0 9.45	6.4 0.25	383.0 15.08	365.0 14.37	21.1 0.83	16.1 0.64	827.7	77.3	0.1568	62.86 138.59
46.833 1.8438	38.100 1.5000	10.2 0.40	10.5 0.41	204.0 8.03	223.0 8.78	3.3 0.13	259.0 10.20	246.0 9.69	5.0 0.20	1.8 0.08	727.9	146.6	0.1310	7.54 16.63
47.625 1.8750	36.512 1.4375	3.8 0.15	3.5 0.14	206.0 8.11	211.0 8.31	3.3 0.13	267.0 10.50	261.0 10.28	8.7 0.34	2.7 0.11	574.6	130.8	0.1155	9.11 20.08
39.688 1.5625	30.162 1.1875	11.4 0.45	3.5 0.14	206.0 8.11	213.0 8.39	3.3 0.13	251.0 9.88	239.0 9.41	3.4 0.13	2.1 0.09	761.7	232.3	0.1296	5.27 11.62
39.688 1.5625	30.162 1.1875	11.4 0.45	3.5 0.14	206.0 8.11	213.0 8.39	3.3 0.13	252.0 9.92	243.0 9.57	3.4 0.13	2.1 0.09	761.7	232.3	0.1296	6.19 13.66
63.500 2.5000	46.038 1.8125	7.9 0.31	4.3 0.17	216.0 8.50	223.0 8.78	3.3 0.13	300.0 11.81	286.0 11.26	9.1 0.36	4.3 0.17	912.5	126.1	0.1460	18.75 41.34
62.000 2.4409	51.000 2.0079	8.1 0.32	3.5 0.14	215.0 8.46	226.0 8.90	2.5 0.10	288.9 11.37	273.0 10.75	4.8 0.18	6.1 0.24	853.6	126.4	0.1428	15.32 33.78
57.945 2.2813	46.038 1.8125	-4.8 -0.19	3.5 0.14	215.0 8.46	219.0 8.62	3.3 0.13	279.0 10.98	272.0 10.71	4.7 0.18	2.0 0.08	954.1	127.9	0.1279	12.51 27.59
63.500 2.5000	46.038 1.8125	7.9 0.31	4.3 0.17	219.0 8.62	225.0 8.86	3.3 0.13	300.0 11.81	286.0 11.26	9.1 0.36	4.3 0.17	912.5	126.1	0.1460	18.28 40.31
63.500 2.5000	50.800 2.0000	7.9 0.31	4.3 0.17	219.0 8.62	225.0 8.86	3.3 0.13	300.0 11.81	285.0 11.22	9.1 0.36	4.3 0.17	912.5	126.1	0.1460	19.15 42.22
63.500 2.5000	46.038 1.8125	7.9 0.31	4.3 0.17	219.0 8.62	225.0 8.86	3.3 0.13	298.0 11.73	287.0 11.30	9.1 0.36	4.3 0.17	912.5	126.1	0.1460	18.73 41.31
69.850 2.7500	49.212 1.9375	-9.9 -0.39	6.8 0.27	226.0 8.90	236.0 9.29	1.5 0.06	330.4 13.01	329.0 12.95	12.2 0.48	3.3 0.13	1162.0	167.6	0.1358	28.14 62.04
112.712 4.4375	90.488 3.5625	-27.9 -1.10	6.4 0.25	231.0 9.09	241.0 9.49	6.4 0.25	362.5 14.27	346.0 13.62	10.2 0.40	2.9 0.12	1964.4	148.4	0.1638	60.49 133.34

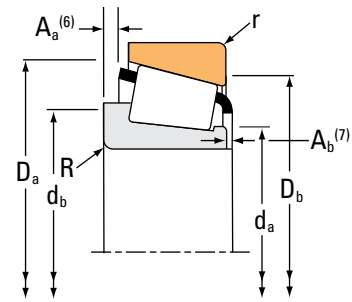
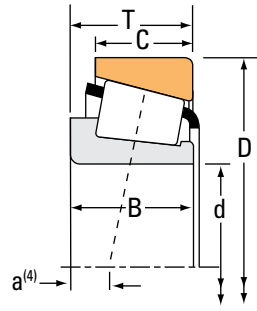
(4) Negative value indicates effective center inside cone (inner-ring) backface.  
 (5) These maximum fillet radii will be cleared by the bearing corners.  
 (6) Negative value indicates cage extends beyond cone (inner-ring) backface.  
 (7) Negative value indicates cage that does not extend beyond cone (inner-ring) front face.

Continued on next page.

# TAPERED ROLLER BEARINGS

## SINGLE-ROW • TYPE TS

### TYPE TS



Bearing Dimensions			Load Ratings							Part Number			
Bore d	O.D. D	Width T	Dynamic <sup>(1)</sup>		Factors <sup>(2)</sup>		Dynamic <sup>(3)</sup>		Factors <sup>(2)</sup>		Static C <sub>0</sub>	Inner	Outer
			C <sub>1</sub>	e	Y	C <sub>90</sub>	C <sub>a90</sub>	K	N	N			
mm in.	mm in.	mm in.	N lbf			N lbf	N lbf		N lbf				
200.025 7.8750	393.700 15.5000	111.125 4.3750	2110000 474000	0.30	2.01	547000 123000	279000 62800	1.96	2600000 585000			HH144642	HH144614
201.612 7.9375	365.049 14.3720	92.075 3.6250	1170000 263000	0.40	1.49	303000 68100	208000 46800	1.45	1820000 409000			EE420793	421437
201.612 7.9375	368.300 14.5000	92.075 3.6250	1170000 263000	0.40	1.49	303000 68100	208000 46800	1.45	1820000 409000			EE420793	421450
203.200 8.0000	261.142 10.2812	28.575 1.1250	208000 46700	0.41	1.47	53900 12100	37700 8480	1.43	405000 91100			LL641149	LL641110
203.200 8.0000	276.225 10.8750	42.862 1.6875	439000 98700	0.32	1.88	114000 25600	62100 14000	1.83	811000 182000			LM241149	LM241110
203.200 8.0000	282.575 11.1250	46.038 1.8125	503000 113000	0.51	1.18	130000 29300	114000 25500	1.15	876000 197000			67983	67920
203.200 8.0000	292.100 11.5000	57.945 2.2813	600000 135000	0.33	1.80	156000 35000	88500 19900	1.76	1170000 263000			M241547	M241510
203.200 8.0000	292.100 11.5000	57.945 2.2813	688000 155000	0.33	1.80	178000 40100	102000 22800	1.76	1170000 263000			M241547C	M241510
203.200 8.0000	317.500 12.5000	53.975 2.1250	559000 126000	0.31	1.91	145000 32600	77800 17500	1.86	900000 202000			EE132083	132125
203.200 8.0000	317.500 12.5000	63.500 2.5000	731000 164000	0.52	1.15	190000 42600	170000 38200	1.12	1290000 290000			93800A	93125
203.200 8.0000	317.500 12.5000	63.500 2.5000	731000 164000	0.52	1.15	190000 42600	170000 38200	1.12	1290000 290000			93800	93125
203.200 8.0000	360.000 14.1732	92.075 3.6250	1170000 263000	0.40	1.49	303000 68100	208000 46800	1.45	1820000 409000			EE420801	421417
203.200 8.0000	365.049 14.3720	92.075 3.6250	1170000 263000	0.40	1.49	303000 68100	208000 46800	1.45	1820000 409000			EE420801	421437
203.200 8.0000	368.300 14.5000	92.075 3.6250	1170000 263000	0.40	1.49	303000 68100	208000 46800	1.45	1820000 409000			EE420801	421450
203.200 8.0000	406.400 16.0000	92.075 3.6250	1220000 274000	0.80	0.75	316000 71000	431000 97000	0.73	1460000 328000			EE114080	114160
203.200 8.0000	482.600 19.0000	117.475 4.6250	1650000 371000	0.87	0.69	428000 96200	635000 143000	0.67	2010000 453000			EE380080	380190
203.238 8.0015	406.400 16.0000	92.075 3.6250	1220000 274000	0.80	0.75	316000 71000	431000 97000	0.73	1460000 328000			EE114081	114160

<sup>(1)</sup>Based on 1 x 10<sup>6</sup> revolutions L<sub>10</sub> life, for the ISO life-calculation method.

<sup>(2)</sup>Consult your Timken engineer for instructions on use or review the Timken Engineering Manual on timken.com/catalogs.

<sup>(3)</sup>Based on 90 x 10<sup>6</sup> revolutions L<sub>10</sub> life, for The Timken Company life-calculation method. C<sub>90</sub> and C<sub>a90</sub> are radial and thrust values.

Bearing Dimensions											Geometry Factors			Bearing Weight
Width B	Width C	Eff. Ctr. a <sup>(4)</sup>	Shaft			Housing			Cage		G <sub>1</sub>	G <sub>2</sub>	C <sub>g</sub>	
			Max Shaft Fillet Radius R <sup>(5)</sup>	Backing Shoulder Dia. d <sub>a</sub>	mm in.	Max Housing Fillet Radius r <sup>(5)</sup>	Backing Shoulder Dia. D <sub>a</sub>	mm in.	A <sub>a</sub> <sup>(6)</sup>	A <sub>b</sub> <sup>(7)</sup>				
mm in.	mm in.	mm in.	mm in.	mm in.	mm in.	mm in.	mm in.	mm in.	mm in.	mm in.			kg lbs.	
111.125 4.3750	84.138 3.3125	-33.8 -1.33	6.4 0.25	226.0 8.90	235.0 9.25	6.4 0.25	356.6 14.04	352.0 13.86	15.6 0.61	1.5 0.06	1470.9	128.3	0.1429	58.53 129.05
88.897 3.4999	63.500 2.5000	-15.5 -0.61	3.3 0.13	226.0 8.90	229.0 9.02	3.3 0.13	334.4 13.16	329.0 12.95	19.1 0.75	2.5 0.10	1150.5	128.2	0.1450	37.37 82.39
88.897 3.4999	63.500 2.5000	-15.5 -0.61	3.3 0.13	226.0 8.90	229.0 9.02	3.3 0.13	334.4 13.16	331.0 13.03	19.1 0.75	2.5 0.10	1150.5	128.2	0.1450	38.30 84.44
27.783 1.0938	21.433 0.8438	15.7 0.62	1.5 0.06	212.0 8.35	214.0 8.43	1.5 0.06	254.0 10.00	249.0 9.80	3.1 0.12	1.7 0.07	521.9	231.1	0.1398	3.48 7.66
42.862 1.6875	34.133 1.3438	1.8 0.07	3.5 0.14	214.1 8.43	220.0 8.66	3.3 0.13	267.0 10.51	260.0 10.24	2.8 0.11	1.4 0.06	774.0	182.2	0.1170	7.02 15.48
46.038 1.8125	36.512 1.4375	16.0 0.63	3.5 0.14	216.0 8.50	222.0 8.74	3.3 0.13	275.0 10.83	260.0 10.24	4.4 0.17	1.7 0.07	819.5	172.0	0.1388	8.65 19.09
57.945 2.2813	46.038 1.8125	-4.8 -0.19	3.5 0.14	217.0 8.54	221.0 8.70	3.3 0.13	279.0 10.98	272.0 10.71	4.7 0.18	2.0 0.08	954.1	127.9	0.1279	12.06 26.58
57.945 2.2813	46.038 1.8125	-4.8 -0.19	3.5 0.14	217.0 8.54	221.0 8.70	3.3 0.13	279.0 10.98	272.0 10.71	4.7 0.18	2.0 0.08	954.1	127.9	0.1279	12.04 26.54
53.975 2.1250	34.925 1.3750	-6.1 -0.24	4.0 0.16	217.9 8.58	225.0 8.86	3.3 0.13	293.1 11.54	293.9 11.57	10.7 0.42	3.2 0.13	797.8	124.6	0.1174	13.87 30.57
63.500 2.5000	46.038 1.8125	7.9 0.31	8.0 0.31	222.0 8.74	234.0 9.21	3.3 0.13	300.0 11.81	286.0 11.26	9.1 0.36	4.3 0.17	912.5	126.1	0.1460	17.64 38.90
63.500 2.5000	46.038 1.8125	7.9 0.31	4.3 0.17	222.0 8.74	227.0 8.94	3.3 0.13	300.0 11.81	286.0 11.26	9.1 0.36	4.3 0.17	912.5	126.1	0.1460	17.78 39.21
88.897 3.4999	63.500 2.5000	-15.5 -0.61	3.3 0.13	227.1 8.94	230.1 9.06	3.3 0.13	334.4 13.16	327.0 12.87	19.1 0.75	2.5 0.10	1150.5	128.2	0.1450	35.60 78.47
88.897 3.4999	63.500 2.5000	-15.5 -0.61	3.3 0.13	227.1 8.94	230.1 9.06	3.3 0.13	334.4 13.16	329.0 12.95	19.1 0.75	2.5 0.10	1150.5	128.2	0.1450	37.02 81.62
88.897 3.4999	63.500 2.5000	-15.5 -0.61	3.3 0.13	227.1 8.94	230.1 9.06	3.3 0.13	334.4 13.16	331.0 13.03	19.1 0.75	2.5 0.10	1150.5	128.2	0.1450	37.95 83.67
85.725 3.3750	57.150 2.2500	24.9 0.98	6.4 0.25	237.0 9.33	246.0 9.69	6.4 0.25	373.7 14.71	349.0 13.74	19.0 0.74	10.7 0.42	794.7	80.2	0.1571	46.85 103.29
95.250 3.7500	73.025 2.8750	34.3 1.35	6.4 0.25	274.0 10.79	280.0 11.02	6.4 0.25	428.5 16.87	402.0 15.83	22.2 0.87	17.0 0.67	1105.0	103.8	0.1792	91.88 202.54
85.725 3.3750	57.150 2.2500	24.9 0.98	6.4 0.25	237.0 9.33	246.0 9.69	6.4 0.25	373.7 14.71	349.0 13.74	19.0 0.74	10.7 0.42	794.7	80.2	0.1571	46.85 103.29

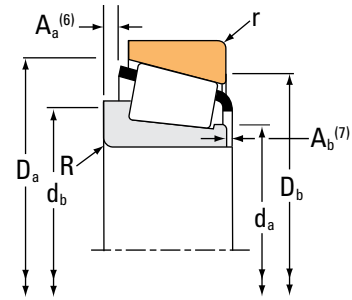
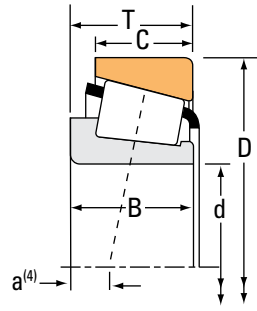
<sup>(4)</sup>Negative value indicates effective center inside cone (inner-ring) backface.  
<sup>(5)</sup>These maximum fillet radii will be cleared by the bearing corners.  
<sup>(6)</sup>Negative value indicates cage extends beyond cone (inner-ring) backface.  
<sup>(7)</sup>Negative value indicates cage that does not extend beyond cone (inner-ring) front face.

Continued on next page.

# TAPERED ROLLER BEARINGS

## SINGLE-ROW • TYPE TS

### TYPE TS



Bearing Dimensions			Load Ratings							Part Number			
Bore d	O.D. D	Width T	Dynamic <sup>(1)</sup>		Factors <sup>(2)</sup>		Dynamic <sup>(3)</sup>		Factors <sup>(2)</sup>		Static C <sub>0</sub>	Inner	Outer
			C <sub>1</sub>	e	Y	C <sub>90</sub>	C <sub>a90</sub>	K	N	N			
mm in.	mm in.	mm in.	N lbf			N lbf	N lbf		N lbf		N lbf		
204.788 8.0625	292.100 11.5000	57.945 2.2813	600000 135000	0.33	1.80	156000 35000	88500 19900	1.76	1170000 263000			M241549	M241510
204.788 8.0625	317.500 12.5000	63.500 2.5000	731000 164000	0.52	1.15	190000 42600	170000 38200	1.12	1290000 290000			93806A	93125
206.375 8.1250	261.142 10.2812	28.575 1.1250	196000 44100	0.41	1.47	50900 11400	35600 8010	1.43	405000 91100			LL641149A	LL641110
206.375 8.1250	282.575 11.1250	46.038 1.8125	503000 113000	0.51	1.18	130000 29300	114000 25500	1.15	876000 197000			67985	67920
206.375 8.1250	317.500 12.5000	53.975 2.1250	528000 119000	0.31	1.91	137000 30800	73400 16500	1.86	900000 202000			EE132084	132125
206.375 8.1250	317.500 12.5000	63.500 2.5000	731000 164000	0.52	1.15	190000 42600	170000 38200	1.12	1290000 290000			93812	93125
206.375 8.1250	336.550 13.2500	98.425 3.8750	1350000 305000	0.33	1.80	351000 79000	200000 45000	1.76	2320000 522000			H242649	H242610
206.375 8.1250	360.000 14.1732	92.075 3.6250	1100000 248000	0.40	1.49	286000 64300	197000 44200	1.45	1820000 409000			EE420812X	421417
206.375 8.1250	482.600 19.0000	117.475 4.6250	1650000 371000	0.87	0.69	428000 96200	635000 143000	0.67	2010000 453000			EE380081	380190
209.550 8.2500	279.400 11.0000	46.038 1.8125	503000 113000	0.51	1.18	130000 29300	114000 25500	1.15	876000 197000			67989	67919
209.550 8.2500	282.575 11.1250	46.038 1.8125	503000 113000	0.51	1.18	130000 29300	114000 25500	1.15	876000 197000			67989	67920
209.550 8.2500	317.500 12.5000	63.500 2.5000	731000 164000	0.52	1.15	190000 42600	170000 38200	1.12	1290000 290000			93825	93125
209.550 8.2500	317.500 12.5000	63.500 2.5000	731000 164000	0.52	1.15	190000 42600	170000 38200	1.12	1290000 290000			93825A	93125
209.550 8.2500	317.500 12.5000	68.262 2.6875	731000 164000	0.52	1.15	190000 42600	170000 38200	1.12	1290000 290000			93825	93126
209.550 8.2500	355.600 14.0000	68.262 2.6875	759000 171000	0.59	1.02	197000 44200	199000 44700	0.99	1420000 319000			96825	96140
212.725 8.3750	285.750 11.2500	46.038 1.8125	430000 96600	0.48	1.25	111000 25000	91800 20600	1.21	892000 200000			LM742745	LM742710
212.725 8.3750	336.550 13.2500	65.088 2.5625	789000 177000	0.33	1.80	204000 46000	116000 26200	1.76	1570000 352000			M246932	M246910

<sup>(1)</sup>Based on 1 x 10<sup>6</sup> revolutions L<sub>10</sub> life, for the ISO life-calculation method.

<sup>(2)</sup>Consult your Timken engineer for instructions on use or review the Timken Engineering Manual on timken.com/catalogs.

<sup>(3)</sup>Based on 90 x 10<sup>6</sup> revolutions L<sub>10</sub> life, for The Timken Company life-calculation method. C<sub>90</sub> and C<sub>a90</sub> are radial and thrust values.

Bearing Dimensions											Geometry Factors			Bearing Weight
Width B	Width C	Eff. Ctr. a <sup>(4)</sup>	Shaft			Housing			Cage		G <sub>1</sub>	G <sub>2</sub>	C <sub>g</sub>	
			Max Shaft Fillet Radius R <sup>(5)</sup>	Backing Shoulder Dia. d <sub>a</sub>	mm d <sub>b</sub>	Max Housing Fillet Radius r <sup>(5)</sup>	Backing Shoulder Dia. D <sub>a</sub>	mm D <sub>b</sub>	A <sub>a</sub> <sup>(6)</sup>	A <sub>b</sub> <sup>(7)</sup>				
mm in.	mm in.	mm in.	mm in.	mm in.	mm in.	mm in.	mm in.	mm in.	mm in.	mm in.			kg lbs.	
57.945 2.2813	46.038 1.8125	-4.8 -0.19	3.5 0.14	219.0 8.62	223.0 8.78	3.3 0.13	279.0 10.98	272.0 10.71	4.7 0.18	2.0 0.08	954.1	127.9	0.1279	11.83 26.08
63.500 2.5000	46.038 1.8125	7.9 0.31	4.3 0.17	223.0 8.78	229.0 9.02	3.3 0.13	300.0 11.81	286.0 11.26	9.1 0.36	4.3 0.17	912.5	126.1	0.1460	17.50 38.60
27.783 1.0938	21.433 0.8438	15.7 0.62	1.5 0.06	212.0 8.35	214.0 8.43	1.5 0.06	254.0 10.00	249.0 9.80	3.1 0.12	1.7 0.07	521.9	231.1	0.1398	3.27 7.21
46.038 1.8125	36.512 1.4375	16.0 0.63	3.5 0.14	219.0 8.62	224.0 8.82	3.3 0.13	275.0 10.83	260.0 10.24	4.4 0.17	1.7 0.07	819.5	172.0	0.1388	8.28 18.28
53.975 2.1250	34.925 1.3750	-6.1 -0.24	4.0 0.16	220.0 8.66	227.1 8.94	3.3 0.13	293.1 11.54	293.9 11.57	10.7 0.42	3.2 0.13	797.8	124.6	0.1174	13.44 29.62
63.500 2.5000	46.038 1.8125	7.9 0.31	4.3 0.17	224.0 8.82	230.0 9.06	3.3 0.13	300.0 11.81	286.0 11.26	9.1 0.36	4.3 0.17	912.5	126.1	0.1460	17.25 38.03
100.012 3.9375	77.788 3.0625	-25.4 -1.00	3.3 0.13	227.0 8.94	231.0 9.09	3.3 0.13	318.0 12.51	306.0 12.05	11.1 0.44	1.9 0.08	1404.1	134.8	0.1465	33.19 73.17
88.897 3.4999	63.500 2.5000	-15.5 -0.61	6.4 0.25	229.0 9.02	239.0 9.41	3.3 0.13	334.4 13.16	327.0 12.87	19.1 0.75	2.5 0.10	1150.5	128.2	0.1450	34.81 76.74
95.250 3.7500	73.025 2.8750	34.3 1.35	6.4 0.25	258.0 10.16	264.0 10.39	6.4 0.25	428.5 16.87	402.0 15.83	22.2 0.87	17.3 0.68	1105.0	103.8	0.1792	91.19 201.03
46.038 1.8125	36.512 1.4375	16.0 0.63	3.5 0.14	221.0 8.70	227.0 8.94	3.3 0.13	273.0 10.75	259.0 10.20	4.4 0.17	1.7 0.07	819.5	172.0	0.1388	7.52 16.58
46.038 1.8125	36.512 1.4375	16.0 0.63	3.5 0.14	221.0 8.70	227.0 8.94	3.3 0.13	275.0 10.83	260.0 10.24	4.4 0.17	1.7 0.07	819.5	172.0	0.1388	7.91 17.45
63.500 2.5000	46.038 1.8125	7.9 0.31	4.3 0.17	226.9 8.93	233.0 9.17	3.3 0.13	300.0 11.81	286.0 11.26	9.1 0.36	4.3 0.17	912.5	126.1	0.1460	16.76 36.96
63.500 2.5000	46.038 1.8125	7.9 0.31	12.7 0.50	226.9 8.93	250.0 9.84	3.3 0.13	300.0 11.81	286.0 11.26	9.1 0.36	4.3 0.17	912.5	126.1	0.1460	16.60 36.60
63.500 2.5000	50.800 2.0000	7.9 0.31	4.3 0.17	226.9 8.93	233.0 9.17	3.3 0.13	300.0 11.81	285.0 11.22	9.1 0.36	4.3 0.17	912.5	126.1	0.1460	17.63 38.86
66.675 2.6250	47.625 1.8750	17.0 0.67	7.0 0.28	235.0 9.25	246.0 9.69	3.3 0.13	334.0 13.15	318.0 12.52	11.9 0.47	3.8 0.15	1140.0	160.6	0.1626	26.70 58.88
46.038 1.8125	34.925 1.3750	14.2 0.56	3.5 0.14	225.0 8.86	230.0 9.06	3.3 0.13	279.0 10.98	266.0 10.47	5.1 0.20	2.0 0.08	866.9	225.2	0.1388	7.97 17.57
65.088 2.5625	50.800 2.0000	-4.8 -0.19	6.4 0.25	235.0 9.25	244.0 9.61	3.3 0.13	322.0 12.68	313.0 12.32	5.1 0.20	3.3 0.13	1354.6	198.0	0.1436	21.86 48.17

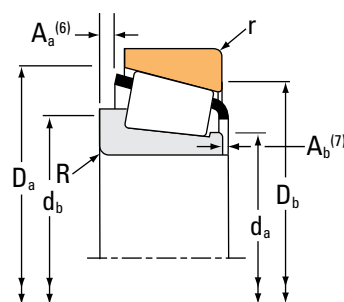
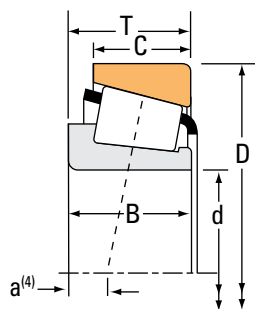
<sup>(4)</sup>Negative value indicates effective center inside cone (inner-ring) backface.  
<sup>(5)</sup>These maximum fillet radii will be cleared by the bearing corners.  
<sup>(6)</sup>Negative value indicates cage extends beyond cone (inner-ring) backface.  
<sup>(7)</sup>Negative value indicates cage that does not extend beyond cone (inner-ring) front face.

Continued on next page.

# TAPERED ROLLER BEARINGS

## SINGLE-ROW • TYPE TS

### TYPE TS



Bearing Dimensions			Load Ratings							Part Number			
Bore d	O.D. D	Width T	Dynamic <sup>(1)</sup>		Factors <sup>(2)</sup>		Dynamic <sup>(3)</sup>		Factors <sup>(2)</sup>		Static C <sub>0</sub>	Inner	Outer
			C <sub>1</sub>	e	Y	C <sub>90</sub>	C <sub>a90</sub>	K	N	N			
mm in.	mm in.	mm in.	N lbf			N lbf	N lbf		N lbf	N lbf	N lbf		
215.900 8.5000	285.750 11.2500	46.038 1.8125	430000 96600	0.48	1.25	111000 25000	91800 20600	1.21	892000 200000			LM742749	LM742710
215.900 8.5000	285.750 11.2500	46.038 1.8125	430000 96600	0.48	1.25	111000 25000	91800 20600	1.21	892000 200000			LM742749AA	LM742710
215.900 8.5000	288.925 11.3750	46.038 1.8125	430000 96600	0.48	1.25	111000 25000	91800 20600	1.21	892000 200000			LM742749	LM742714
215.900 8.5000	290.010 11.4177	31.750 1.2500	239000 53800	0.39	1.56	62000 13900	40900 9190	1.52	453000 102000			543085	543114
215.900 8.5000	355.600 14.0000	69.850 2.7500	796000 179000	0.33	1.82	206000 46400	117000 26200	1.77	1400000 314000			EE130851	131400
215.900 8.5000	360.000 14.1732	82.550 3.2500	1100000 248000	0.40	1.49	286000 64300	197000 44200	1.45	1820000 409000			EE420850	421417
215.900 8.5000	365.049 14.3720	82.550 3.2500	1100000 248000	0.40	1.49	286000 64300	197000 44200	1.45	1820000 409000			EE420850	421437
219.969 8.6602	290.010 11.4177	31.750 1.2500	239000 53800	0.39	1.56	62000 13900	40900 9190	1.52	453000 102000			543086	543114
219.969 8.6602	292.009 11.4964	31.750 1.2500	239000 53800	0.39	1.56	62000 13900	40900 9190	1.52	453000 102000			543086	543116
219.975 8.6604	384.175 15.1250	112.712 4.4375	1920000 432000	0.33	1.80	498000 112000	284000 63700	1.76	3110000 699000			H247540	H247510
220.662 8.6875	314.325 12.3750	61.912 2.4375	695000 156000	0.33	1.80	180000 40500	103000 23100	1.76	1370000 308000			M244249	M244210
220.662 8.6875	314.325 12.3750	61.912 2.4375	649000 146000	0.33	1.80	168000 37800	95800 21500	1.76	1240000 279000			M244249A	M244210
222.250 8.7500	482.600 19.0000	117.475 4.6250	1650000 371000	0.87	0.69	428000 96200	635000 143000	0.67	2010000 453000			EE380875	380190
223.838 8.8125	295.275 11.6250	46.038 1.8125	516000 116000	0.50	1.20	134000 30100	114000 25700	1.17	919000 207000			LM844049	LM844010
225.425 8.8750	355.600 14.0000	69.850 2.7500	796000 179000	0.33	1.82	206000 46400	117000 26200	1.77	1400000 314000			EE130889	131400
225.425 8.8750	400.050 15.7500	88.900 3.5000	1120000 253000	0.44	1.36	291000 65500	219000 49300	1.33	1920000 432000			EE430888	431575
227.330 8.9500	406.400 16.0000	63.500 2.5000	955000 215000	0.47	1.27	248000 55600	200000 45000	1.24	1280000 287000			EE710905	711600

<sup>(1)</sup>Based on 1 x 10<sup>6</sup> revolutions L<sub>10</sub> life, for the ISO life-calculation method.

<sup>(2)</sup>Consult your Timken engineer for instructions on use or review the Timken Engineering Manual on timken.com/catalogs.

<sup>(3)</sup>Based on 90 x 10<sup>6</sup> revolutions L<sub>10</sub> life, for The Timken Company life-calculation method. C<sub>90</sub> and C<sub>a90</sub> are radial and thrust values.



Bearing Dimensions											Geometry Factors			Bearing Weight
Width B	Width C	Eff. Ctr. a <sup>(4)</sup>	Shaft			Housing			Cage		G <sub>1</sub>	G <sub>2</sub>	C <sub>g</sub>	
			Max Shaft Fillet Radius R <sup>(5)</sup>	Backing Shoulder Dia. d <sub>a</sub>	mm in.	Max Housing Fillet Radius r <sup>(5)</sup>	Backing Shoulder Dia. D <sub>a</sub>	mm in.	A <sub>a</sub> <sup>(6)</sup>	A <sub>b</sub> <sup>(7)</sup>				
mm in.	mm in.	mm in.	mm in.	mm in.	mm in.	mm in.	mm in.	mm in.	mm in.	mm in.			kg lbs.	
46.038 1.8125	34.925 1.3750	14.2 0.56	3.5 0.14	227.0 8.94	233.0 9.17	3.3 0.13	279.0 10.98	266.0 10.47	5.1 0.20	2.0 0.08	866.9	225.2	0.1388	7.59 16.72
46.038 1.8125	34.925 1.3750	14.2 0.56	8.9 0.35	227.0 8.94	242.0 9.57	3.3 0.13	279.0 10.98	266.0 10.47	5.1 0.20	2.0 0.08	866.9	225.2	0.1388	7.51 16.55
46.038 1.8125	34.925 1.3750	14.2 0.56	3.5 0.14	227.0 8.94	233.0 9.17	3.3 0.13	280.0 11.02	267.0 10.51	5.1 0.20	2.0 0.08	866.9	225.2	0.1388	7.95 17.52
31.750 1.2500	22.225 0.8750	13.0 0.51	3.5 0.14	226.0 8.90	232.0 9.13	3.3 0.13	276.0 10.87	272.0 10.71	4.1 0.16	2.8 0.11	608.5	232.3	0.1135	5.42 11.96
69.850 2.7500	49.212 1.9375	-9.9 -0.39	6.8 0.27	237.0 9.33	248.0 9.76	1.5 0.06	330.4 13.01	329.0 12.95	12.2 0.48	3.3 0.13	1162.0	167.6	0.1358	25.30 55.78
79.372 3.1249	63.500 2.5000	-6.1 -0.24	1.5 0.06	236.0 9.29	236.0 9.29	3.3 0.13	334.4 13.16	327.0 12.87	9.6 0.37	2.5 0.10	1150.5	128.2	0.1450	30.88 68.06
79.372 3.1249	63.500 2.5000	-6.1 -0.24	1.5 0.06	236.0 9.29	236.0 9.29	3.3 0.13	334.4 13.16	329.0 12.95	9.6 0.37	2.5 0.10	1150.5	128.2	0.1450	32.30 71.21
31.750 1.2500	22.225 0.8750	13.0 0.51	3.5 0.14	229.0 9.02	235.0 9.25	3.3 0.13	276.0 10.87	272.0 10.71	4.1 0.16	2.8 0.11	608.5	232.3	0.1135	5.08 11.20
31.750 1.2500	22.225 0.8750	13.0 0.51	3.5 0.14	229.0 9.02	235.0 9.25	3.3 0.13	276.0 10.87	273.0 10.75	4.1 0.16	2.8 0.11	608.5	232.3	0.1135	5.21 11.49
112.712 4.4375	90.488 3.5625	-27.9 -1.10	6.4 0.25	259.0 10.20	269.0 10.59	6.4 0.25	362.5 14.27	346.0 13.62	10.2 0.40	2.9 0.12	1964.4	148.4	0.1638	54.81 120.81
61.912 2.4375	49.212 1.9375	-4.6 -0.18	6.4 0.25	235.0 9.25	245.0 9.65	3.3 0.13	300.0 11.81	293.0 11.54	4.9 0.19	2.5 0.10	1149.7	141.4	0.1360	14.52 32.03
66.675 2.6250	49.212 1.9375	-4.6 -0.18	1.5 0.06	235.0 9.25	235.0 9.25	3.3 0.13	300.0 11.81	293.0 11.54	3.2 0.12	0.4 0.02	1073.1	132.4	0.1327	14.91 32.89
95.250 3.7500	73.025 2.8750	34.3 1.35	6.4 0.25	267.0 10.51	277.0 10.91	6.4 0.25	428.5 16.87	402.0 15.83	22.2 0.87	17.3 0.68	1105.0	103.8	0.1792	87.21 192.25
46.038 1.8125	34.925 1.3750	17.0 0.67	3.5 0.14	235.0 9.25	241.0 9.49	3.3 0.13	288.0 11.34	275.0 10.83	5.2 0.20	2.0 0.08	927.3	268.8	0.1434	8.02 17.69
69.850 2.7500	49.212 1.9375	-9.9 -0.39	6.8 0.27	244.0 9.61	255.0 10.04	1.5 0.06	330.4 13.01	329.0 12.95	12.2 0.48	3.3 0.13	1162.0	167.6	0.1358	22.94 50.59
87.312 3.4375	63.500 2.5000	-4.8 -0.19	1.5 0.06	251.0 9.88	251.0 9.88	3.3 0.13	364.2 14.34	360.0 14.17	14.8 0.58	1.5 0.06	1351.2	142.8	0.1572	43.79 96.54
61.912 2.4375	39.688 1.5625	12.2 0.48	7.0 0.28	248.9 9.80	261.9 10.31	6.4 0.25	372.1 14.65	368.0 14.49	9.4 0.37	7.4 0.29	914.9	114.2	0.1402	31.26 68.91

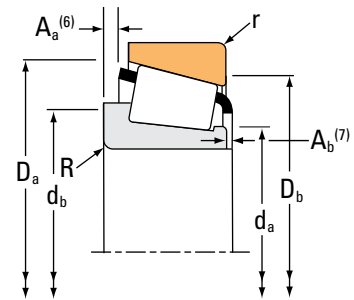
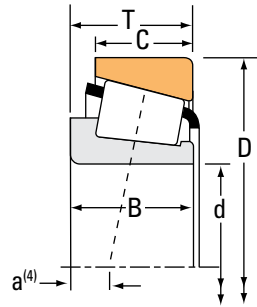
(4) Negative value indicates effective center inside cone (inner-ring) backface.  
 (5) These maximum fillet radii will be cleared by the bearing corners.  
 (6) Negative value indicates cage extends beyond cone (inner-ring) backface.  
 (7) Negative value indicates cage that does not extend beyond cone (inner-ring) front face.

Continued on next page.

# TAPERED ROLLER BEARINGS

## SINGLE-ROW • TYPE TS

### TYPE TS



Bearing Dimensions			Load Ratings							Part Number		
Bore d	O.D. D	Width T	Dynamic <sup>(1)</sup>		Factors <sup>(2)</sup>		Dynamic <sup>(3)</sup>		Factors <sup>(2)</sup>	Static	Inner	Outer
			C <sub>1</sub>	e	Y	C <sub>90</sub>	C <sub>a90</sub>	K	C <sub>0</sub>			
mm in.	mm in.	mm in.	N lbf			N lbf	N lbf			N lbf		
228.397 8.9920	431.800 17.0000	92.075 3.6250	1270000 287000	0.88	0.68	330000 74300	500000 112000	0.66	1600000 361000	EE113089	113170	
228.460 8.9945	431.800 17.0000	92.075 3.6250	1270000 287000	0.88	0.68	330000 74300	500000 112000	0.66	1600000 361000	EE113091	113170	
228.600 9.0000	295.275 11.6250	33.338 1.3125	238000 53400	0.40	1.49	61600 13900	42400 9530	1.45	458000 103000	544090	544116	
228.600 9.0000	300.038 11.8125	33.338 1.3125	238000 53400	0.40	1.49	61600 13900	42400 9530	1.45	458000 103000	544090	544118	
228.600 9.0000	320.675 12.6250	50.800 2.0000	552000 124000	0.49	1.23	143000 32200	119000 26800	1.20	821000 185000	88900	88126	
228.600 9.0000	327.025 12.8750	52.388 2.0625	552000 124000	0.49	1.23	143000 32200	119000 26800	1.20	821000 185000	88900	88128	
228.600 9.0000	327.025 12.8750	52.388 2.0625	558000 126000	0.41	1.48	145000 32500	101000 22700	1.44	1070000 240000	8573	8520	
228.600 9.0000	355.600 14.0000	68.262 2.6875	759000 171000	0.59	1.02	197000 44200	199000 44700	0.99	1420000 319000	96900	96140	
228.600 9.0000	355.600 14.0000	69.850 2.7500	843000 190000	0.33	1.82	219000 49100	124000 27800	1.77	1400000 314000	EE130902	131400	
228.600 9.0000	355.600 14.0000	69.850 2.7500	951000 214000	0.47	1.27	247000 55400	200000 44900	1.24	1690000 380000	HM746646	HM746610	
228.600 9.0000	358.775 14.1250	71.438 2.8125	914000 206000	0.33	1.80	237000 53300	135000 30300	1.76	1850000 416000	M249732	M249710	
228.600 9.0000	400.050 15.7500	88.900 3.5000	1120000 253000	0.44	1.36	291000 65500	219000 49300	1.33	1920000 432000	EE430900	431575	
228.600 9.0000	406.400 16.0000	63.500 2.5000	955000 215000	0.47	1.27	248000 55600	200000 45000	1.24	1280000 287000	EE710906	711600	
228.600 9.0000	425.450 16.7500	101.600 4.0000	1700000 382000	0.33	1.80	440000 99000	251000 56400	1.76	2140000 481000	EE700091	700167	
228.600 9.0000	488.950 19.2500	123.825 4.8750	2240000 505000	0.94	0.64	582000 131000	934000 210000	0.62	2510000 564000	HH949549	HH949510	
228.600 9.0000	508.000 20.0000	117.475 4.6250	1680000 377000	0.94	0.64	434000 97700	697000 157000	0.62	2100000 473000	EE390090	390200	
231.775 9.1250	358.775 14.1250	71.438 2.8125	914000 206000	0.33	1.80	237000 53300	135000 30300	1.76	1850000 416000	M249734	M249710	

<sup>(1)</sup>Based on 1 x 10<sup>6</sup> revolutions L<sub>10</sub> life, for the ISO life-calculation method.

<sup>(2)</sup>Consult your Timken engineer for instructions on use or review the Timken Engineering Manual on timken.com/catalogs.

<sup>(3)</sup>Based on 90 x 10<sup>6</sup> revolutions L<sub>10</sub> life, for The Timken Company life-calculation method. C<sub>90</sub> and C<sub>a90</sub> are radial and thrust values.

Bearing Dimensions											Geometry Factors			Bearing Weight
Width B	Width C	Eff. Ctr. a <sup>(4)</sup>	Shaft			Housing			Cage		G <sub>1</sub>	G <sub>2</sub>	C <sub>g</sub>	
			Max Shaft Fillet Radius R <sup>(5)</sup>	Backing Shoulder Dia. d <sub>a</sub>	Shoulder Dia. d <sub>b</sub>	Max Housing Fillet Radius r <sup>(5)</sup>	Backing Shoulder Dia. D <sub>a</sub>	Shoulder Dia. D <sub>b</sub>	A <sub>a</sub> <sup>(6)</sup>	A <sub>b</sub> <sup>(7)</sup>				
mm in.	mm in.	mm in.	mm in.	mm in.	mm in.	mm in.	mm in.	mm in.	mm in.	mm in.				kg lbs.
85.725 3.3750	49.212 1.9375	41.4 1.63	6.4 0.25	267.0 10.51	274.0 10.79	6.4 0.25	397.2 15.64	375.0 14.76	19.4 0.76	11.5 0.46	966.7	98.1	0.1723	51.03 112.50
85.725 3.3750	49.212 1.9375	41.4 1.63	6.4 0.25	267.0 10.51	274.0 10.79	6.4 0.25	397.2 15.64	375.0 14.76	19.4 0.76	11.5 0.46	966.7	98.1	0.1723	50.09 110.43
31.750 1.2500	23.812 0.9375	15.7 0.62	3.5 0.14	240.0 9.45	244.0 9.61	3.3 0.13	287.0 11.30	280.0 11.02	4.2 0.16	2.8 0.11	648.6	279.2	0.1174	5.14 11.32
31.750 1.2500	23.812 0.9375	15.7 0.62	3.5 0.14	240.0 9.45	244.0 9.61	3.3 0.13	287.0 11.30	282.0 11.10	4.2 0.16	2.8 0.11	648.6	279.2	0.1174	5.53 12.17
49.212 1.9375	33.338 1.3125	14.2 0.56	6.4 0.25	242.0 9.53	253.0 9.96	3.3 0.13	309.0 12.17	299.0 11.77	11.1 0.43	2.7 0.11	800.1	189.1	0.1352	11.02 24.28
49.212 1.9375	34.925 1.3750	14.2 0.56	6.4 0.25	242.0 9.53	253.0 9.96	3.3 0.13	309.0 12.17	302.0 11.89	11.1 0.43	2.7 0.11	800.1	189.1	0.1352	12.09 26.65
52.388 2.0625	36.512 1.4375	7.6 0.30	6.4 0.25	244.0 9.61	255.0 10.04	3.3 0.13	313.0 12.32	305.0 12.01	7.0 0.27	2.2 0.09	1050.5	172.4	0.1401	13.27 29.26
66.675 2.6250	47.625 1.8750	17.0 0.67	7.0 0.28	249.0 9.80	260.0 10.24	3.3 0.13	334.0 13.15	318.0 12.52	11.9 0.47	3.8 0.15	1140.0	160.6	0.1626	23.36 51.51
69.850 2.7500	49.212 1.9375	-9.9 -0.39	6.8 0.27	247.0 9.72	257.0 10.12	1.5 0.06	330.4 13.01	329.0 12.95	12.2 0.48	3.3 0.13	1162.0	167.6	0.1358	22.87 50.42
69.850 2.7500	50.800 2.0000	6.9 0.27	6.4 0.25	248.0 9.76	258.0 10.16	6.4 0.25	338.7 13.34	324.0 12.76	6.1 0.24	4.5 0.18	1185.7	149.4	0.1542	26.30 57.99
71.438 2.8125	53.975 2.1250	-6.9 -0.27	3.5 0.14	251.0 9.88	256.0 10.08	3.3 0.13	343.0 13.50	335.0 13.19	8.0 0.31	3.1 0.12	1626.0	173.0	0.1526	26.77 59.03
87.312 3.4375	63.500 2.5000	-4.8 -0.19	10.5 0.41	253.0 9.96	271.0 10.67	3.3 0.13	364.2 14.34	360.0 14.17	14.8 0.58	1.5 0.06	1351.2	142.8	0.1572	42.71 94.16
61.912 2.4375	39.688 1.5625	12.2 0.48	7.0 0.28	249.9 9.84	262.9 10.35	6.4 0.25	372.1 14.65	368.0 14.49	9.4 0.37	7.4 0.29	914.9	114.2	0.1402	31.04 68.42
95.250 3.7500	76.200 3.0000	-21.1 -0.83	7.0 0.28	259.0 10.20	266.0 10.47	6.4 0.25	384.0 15.12	381.0 15.00	20.8 0.81	1.1 0.05	1488.7	109.7	0.1480	56.57 124.72
111.125 4.3750	73.025 2.8750	39.9 1.57	6.4 0.25	280.0 11.02	297.0 11.69	6.4 0.25	456.0 17.95	416.0 16.38	21.4 0.84	11.8 0.47	1295.5	91.5	0.1931	98.91 218.07
95.250 3.7500	73.025 2.8750	49.5 1.95	6.4 0.25	277.0 10.91	287.0 11.30	6.4 0.25	456.2 17.96	423.0 16.65	22.4 0.88	19.2 0.76	1258.2	106.2	0.1909	98.28 216.68
71.438 2.8125	53.975 2.1250	-6.9 -0.27	6.4 0.25	254.0 10.00	263.0 10.35	3.3 0.13	343.0 13.50	335.0 13.19	8.0 0.31	3.1 0.12	1626.0	173.0	0.1526	26.05 57.44

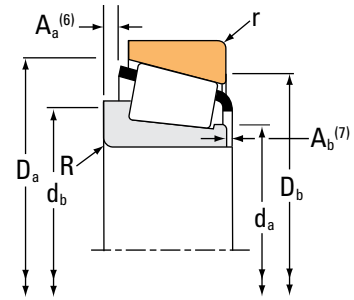
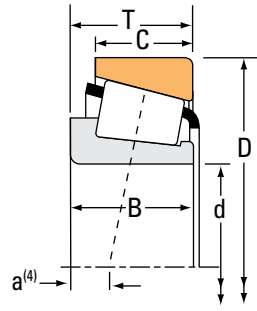
(4) Negative value indicates effective center inside cone (inner-ring) backface.  
 (5) These maximum fillet radii will be cleared by the bearing corners.  
 (6) Negative value indicates cage extends beyond cone (inner-ring) backface.  
 (7) Negative value indicates cage that does not extend beyond cone (inner-ring) front face.

Continued on next page.

# TAPERED ROLLER BEARINGS

## SINGLE-ROW • TYPE TS

### TYPE TS



Bearing Dimensions			Load Ratings							Part Number			
Bore d	O.D. D	Width T	Dynamic <sup>(1)</sup>		Factors <sup>(2)</sup>		Dynamic <sup>(3)</sup>		Factors <sup>(2)</sup>		Static C <sub>0</sub>	Inner	Outer
			C <sub>1</sub>	e	Y	C <sub>90</sub>	C <sub>a90</sub>	K	N	N			
mm in.	mm in.	mm in.	N lbf			N lbf	N lbf		N lbf				
231.775 9.1250	268.288 10.5625	22.500 0.8858	146000 32900	0.33	1.80	37900 8520	21600 4850	1.76	349000 78500			LL244549	LL244510
231.775 9.1250	295.275 11.6250	33.338 1.3125	238000 53400	0.40	1.49	61600 13900	42400 9530	1.45	458000 103000			544091	544116
231.775 9.1250	300.038 11.8125	33.338 1.3125	238000 53400	0.40	1.49	61600 13900	42400 9530	1.45	458000 103000			544091	544118
231.775 9.1250	336.550 13.2500	65.088 2.5625	789000 177000	0.33	1.80	204000 46000	116000 26200	1.76	1570000 352000			M246942	M246910
231.775 9.1250	358.775 14.1250	71.438 2.8125	1150000 258000	0.33	1.80	297000 66900	169000 38100	1.76	1850000 416000			M249734H	M249710X
234.950 9.2500	311.150 12.2500	46.038 1.8125	441000 99200	0.36	1.66	114000 25700	70900 15900	1.61	926000 208000			LM446349	LM446310
234.950 9.2500	314.325 12.3750	49.212 1.9375	519000 117000	0.40	1.51	135000 30200	91500 20600	1.47	1040000 233000			LM545849	LM545810
234.950 9.2500	314.325 12.3750	49.212 1.9375	519000 117000	0.40	1.51	135000 30200	91500 20600	1.47	1040000 233000			LM545849A	LM545810
234.950 9.2500	314.325 12.3750	49.212 1.9375	560000 126000	0.40	1.51	145000 32600	98800 22200	1.47	949000 213000			LM545849E	LM545810
234.950 9.2500	317.500 12.5000	49.212 1.9375	519000 117000	0.40	1.51	135000 30200	91500 20600	1.47	1040000 233000			LM545849	LM545812
234.950 9.2500	320.675 12.6250	50.800 2.0000	552000 124000	0.49	1.23	143000 32200	119000 26800	1.20	821000 185000			88925	88126
234.950 9.2500	327.025 12.8750	52.388 2.0625	552000 124000	0.49	1.23	143000 32200	119000 26800	1.20	821000 185000			88925	88128
234.950 9.2500	327.025 12.8750	52.388 2.0625	558000 126000	0.41	1.48	145000 32500	101000 22700	1.44	1070000 240000			8575	8520
234.950 9.2500	355.600 14.0000	68.262 2.6875	759000 171000	0.59	1.02	197000 44200	199000 44700	0.99	1420000 319000			96925	96140
234.950 9.2500	381.000 15.0000	74.612 2.9375	1260000 283000	0.33	1.80	326000 73200	185000 41700	1.76	2030000 455000			M252330	M252310
234.950 9.2500	384.175 15.1250	112.712 4.4375	1670000 377000	0.33	1.80	434000 97600	247000 55600	1.76	3110000 699000			H247549	H247510
234.950 9.2500	384.175 15.1250	112.713 4.4375	1880000 422000	0.33	1.80	486000 109000	277000 62200	1.76	3370000 757000			H247548	H247510

<sup>(1)</sup>Based on 1 x 10<sup>6</sup> revolutions L<sub>10</sub> life, for the ISO life-calculation method.

<sup>(2)</sup>Consult your Timken engineer for instructions on use or review the Timken Engineering Manual on timken.com/catalogs.

<sup>(3)</sup>Based on 90 x 10<sup>6</sup> revolutions L<sub>10</sub> life, for The Timken Company life-calculation method. C<sub>90</sub> and C<sub>a90</sub> are radial and thrust values.

Bearing Dimensions											Geometry Factors			Bearing Weight
Width B	Width C	Eff. Ctr. a <sup>(4)</sup>	Shaft			Housing			Cage		G <sub>1</sub>	G <sub>2</sub>	C <sub>g</sub>	
			Max Shaft Fillet Radius R <sup>(5)</sup>	Backing Shoulder Dia. d <sub>a</sub>	Backing Shoulder Dia. d <sub>b</sub>	Max Housing Fillet Radius r <sup>(5)</sup>	Backing Shoulder Dia. D <sub>a</sub>	Backing Shoulder Dia. D <sub>b</sub>	A <sub>a</sub> <sup>(6)</sup>	A <sub>b</sub> <sup>(7)</sup>				
mm in.	mm in.	mm in.	mm in.	mm in.	mm in.	mm in.	mm in.	mm in.	mm in.	mm in.				kg lbs.
21.500 0.8465	18.500 0.7283	15.7 0.62	2.0 0.08	237.0 9.33	241.0 9.49	2.0 0.08	263.0 10.35	259.0 10.20	0.2 0.01	2.4 0.10	693.6	584.8	0.1422	1.85 4.09
31.750 1.2500	23.812 0.9375	15.7 0.62	3.5 0.14	243.1 9.57	246.9 9.72	3.3 0.13	287.0 11.30	280.0 11.02	4.2 0.16	2.8 0.11	648.6	279.2	0.1174	4.85 10.68
31.750 1.2500	23.812 0.9375	15.7 0.62	3.5 0.14	243.1 9.57	246.9 9.72	3.3 0.13	287.0 11.30	282.0 11.10	4.2 0.16	2.8 0.11	648.6	279.2	0.1174	5.24 11.54
65.088 2.5625	50.800 2.0000	-4.8 -0.19	6.4 0.25	249.0 9.80	258.0 10.16	3.3 0.13	322.0 12.68	313.0 12.32	5.1 0.20	3.3 0.13	1354.6	198.0	0.1436	18.53 40.85
71.438 2.8125	53.975 2.1250	-6.9 -0.27	6.4 0.25	255.0 10.04	265.0 10.43	3.3 0.13	343.0 13.50	335.0 13.19	7.9 0.31	3.1 0.13	1626.0	173.0	0.1526	26.40 58.20
46.038 1.8125	33.338 1.3125	6.6 0.26	3.5 0.14	246.0 9.69	252.0 9.92	3.3 0.13	301.0 11.85	294.0 11.57	5.5 0.21	1.6 0.07	1008.4	243.6	0.1328	8.70 19.18
49.212 1.9375	36.512 1.4375	8.4 0.33	3.5 0.14	246.0 9.69	252.0 9.92	3.3 0.13	306.0 12.05	296.0 11.65	4.4 0.17	2.9 0.12	997.1	163.2	0.1367	9.85 21.70
49.212 1.9375	36.512 1.4375	8.4 0.33	6.4 0.25	246.0 9.69	258.0 10.16	3.3 0.13	306.0 12.05	296.0 11.65	4.4 0.17	2.9 0.12	997.1	163.2	0.1367	9.91 21.84
53.975 2.1250	36.512 1.4375	8.4 0.33	3.5 0.14	247.0 9.72	252.0 9.92	3.3 0.13	306.0 12.05	296.0 11.65	4.2 0.16	0.0 0.00	938.2	175.8	0.1338	10.18 22.42
49.212 1.9375	36.512 1.4375	8.4 0.33	3.5 0.14	246.0 9.69	252.0 9.92	3.3 0.13	306.0 12.05	297.0 11.69	4.4 0.17	2.9 0.12	997.1	163.2	0.1367	10.27 22.63
49.212 1.9375	33.338 1.3125	14.2 0.56	6.4 0.25	246.0 9.69	258.0 10.16	3.3 0.13	309.0 12.17	299.0 11.77	11.1 0.43	2.7 0.11	800.1	189.1	0.1352	10.12 22.31
49.212 1.9375	34.925 1.3750	14.2 0.56	6.4 0.25	246.0 9.69	258.0 10.16	3.3 0.13	309.0 12.17	302.0 11.89	11.1 0.43	2.7 0.11	800.1	189.1	0.1352	11.19 24.69
52.388 2.0625	36.512 1.4375	7.6 0.30	6.4 0.25	248.0 9.76	259.0 10.20	3.3 0.13	313.0 12.32	305.0 12.01	7.0 0.27	2.2 0.09	1050.5	172.4	0.1401	12.32 27.16
66.675 2.6250	47.625 1.8750	17.0 0.67	7.0 0.28	254.0 10.00	265.0 10.43	3.3 0.13	334.0 13.15	318.0 12.52	11.9 0.47	3.8 0.15	1140.0	160.6	0.1626	22.15 48.85
74.612 2.9375	57.150 2.2500	-6.6 -0.26	6.4 0.25	261.0 10.28	271.0 10.67	3.3 0.13	364.0 14.32	356.0 14.02	8.3 0.32	3.6 0.14	1839.2	226.1	0.1588	33.48 73.80
112.712 4.4375	90.488 3.5625	-27.9 -1.10	6.4 0.25	263.0 10.35	273.0 10.75	6.4 0.25	362.5 14.27	346.0 13.62	10.2 0.40	2.9 0.12	1964.4	148.4	0.1638	50.04 110.32
112.712 4.4375	90.488 3.5625	-27.9 -1.10	6.4 0.25	259.0 10.20	269.0 10.59	6.4 0.25	362.5 14.27	346.0 13.62	8.5 0.33	4.4 0.18	2077.6	156.6	0.1671	51.64 113.84

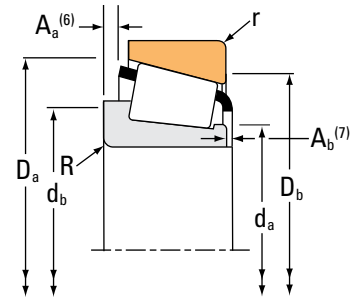
(4) Negative value indicates effective center inside cone (inner-ring) backface.  
 (5) These maximum fillet radii will be cleared by the bearing corners.  
 (6) Negative value indicates cage extends beyond cone (inner-ring) backface.  
 (7) Negative value indicates cage that does not extend beyond cone (inner-ring) front face.

Continued on next page.

# TAPERED ROLLER BEARINGS

## SINGLE-ROW • TYPE TS

### TYPE TS



Bearing Dimensions			Load Ratings							Part Number		
Bore d	O.D. D	Width T	Dynamic <sup>(1)</sup>		Factors <sup>(2)</sup>		Dynamic <sup>(3)</sup>		Factors <sup>(2)</sup>	Static	Inner	Outer
			C <sub>1</sub>	e	Y	C <sub>90</sub>	C <sub>a90</sub>	K	C <sub>0</sub>			
mm in.	mm in.	mm in.	N lbf			N lbf	N lbf			N lbf		
235.077 9.2550	314.325 12.3750	49.212 1.9375	613000 138000	0.40	1.51	159000 35700	108000 24300	1.47		949000 213000	LM545847	LM545810
235.331 9.2650	336.550 13.2500	65.088 2.5625	924000 208000	0.33	1.80	240000 53800	136000 30700	1.76		1420000 319000	M246947	M246910
235.331 9.2650	336.550 13.2500	65.088 2.5625	924000 208000	0.33	1.80	240000 53800	136000 30700	1.76		1420000 319000	M246947AA	M246910
236.538 9.3125	320.675 12.6250	44.450 1.7500	552000 124000	0.49	1.23	143000 32200	119000 26800	1.20		821000 185000	88931	88126
236.538 9.3125	320.675 12.6250	44.450 1.7500	552000 124000	0.49	1.23	143000 32200	119000 26800	1.20		821000 185000	88931H	88126
237.330 9.3437	336.550 13.2500	65.088 2.5625	789000 177000	0.33	1.80	204000 46000	116000 26200	1.76		1570000 352000	M246949	M246910
237.330 9.3437	336.550 13.2500	65.088 2.5625	845000 190000	0.33	1.80	219000 49200	125000 28000	1.76		1420000 319000	M246948	M246910
237.330 9.3437	358.775 14.1250	71.438 2.8125	914000 206000	0.33	1.80	237000 53300	135000 30300	1.76		1850000 416000	M249736	M249710
240.000 9.4488	320.000 12.5984	42.000 1.6535	440000 99000	0.46	1.31	114000 25700	89300 20100	1.28		808000 182000	JP24049	JP24010
241.122 9.4930	368.300 14.5000	68.262 2.6875	844000 190000	0.34	1.75	219000 49200	129000 28900	1.70		1530000 345000	EE125094	125145
241.300 9.5000	327.025 12.8750	52.388 2.0625	527000 119000	0.41	1.48	137000 30700	95200 21400	1.44		1070000 240000	8578	8520
241.300 9.5000	349.148 13.7460	57.150 2.2500	660000 148000	0.35	1.70	171000 38500	103000 23300	1.65		1250000 282000	EE127095	127135
241.300 9.5000	355.498 13.9960	57.150 2.2500	660000 148000	0.35	1.70	171000 38500	103000 23300	1.65		1250000 282000	EE127095	127138
241.300 9.5000	355.600 14.0000	50.800 2.0000	643000 144000	0.36	1.65	167000 37500	104000 23300	1.61		1030000 231000	EE170950	171400
241.300 9.5000	355.600 14.0000	57.150 2.2500	660000 148000	0.35	1.70	171000 38500	103000 23300	1.65		1250000 282000	EE127095	127140
241.300 9.5000	365.049 14.3720	50.800 2.0000	643000 144000	0.36	1.65	167000 37500	104000 23300	1.61		1030000 231000	EE170950	171436
241.300 9.5000	368.300 14.5000	50.800 2.0000	643000 144000	0.36	1.65	167000 37500	104000 23300	1.61		1030000 231000	EE170950	171450

<sup>(1)</sup>Based on 1 x 10<sup>6</sup> revolutions L<sub>10</sub> life, for the ISO life-calculation method.

<sup>(2)</sup>Consult your Timken engineer for instructions on use or review the Timken Engineering Manual on timken.com/catalogs.

<sup>(3)</sup>Based on 90 x 10<sup>6</sup> revolutions L<sub>10</sub> life, for The Timken Company life-calculation method. C<sub>90</sub> and C<sub>a90</sub> are radial and thrust values.

Bearing Dimensions											Geometry Factors			Bearing Weight
Width B	Width C	Eff. Ctr. a <sup>(4)</sup>	Shaft			Housing			Cage		G <sub>1</sub>	G <sub>2</sub>	C <sub>g</sub>	
			Max Shaft Fillet Radius R <sup>(5)</sup>	Backing Shoulder Dia. d <sub>a</sub>	Backing Shoulder Dia. d <sub>b</sub>	Max Housing Fillet Radius r <sup>(5)</sup>	Backing Shoulder Dia. D <sub>a</sub>	Backing Shoulder Dia. D <sub>b</sub>	A <sub>a</sub> <sup>(6)</sup>	A <sub>b</sub> <sup>(7)</sup>				
mm in.	mm in.	mm in.	mm in.	mm in.	mm in.	mm in.	mm in.	mm in.	mm in.	mm in.				kg lbs.
53.975 2.1250	36.512 1.4375	8.4 0.33	3.5 0.14	247.0 9.72	252.0 9.92	3.3 0.13	306.0 12.05	296.0 11.65	4.2 0.16	0.0 0.00	938.2	175.8	0.1338	10.16 22.37
69.850 2.7500	50.800 2.0000	-4.8 -0.19	2.3 0.09	251.0 9.88	253.0 9.96	3.3 0.13	322.0 12.68	313.0 12.32	4.2 0.16	1.2 0.05	1264.4	185.4	0.1401	18.28 40.30
65.088 2.5625	50.800 2.0000	-4.8 -0.19	2.3 0.09	251.0 9.88	253.0 9.96	3.3 0.13	322.0 12.68	313.0 12.32	4.2 0.16	6.0 0.24	1264.4	185.4	0.1401	17.83 39.31
44.450 1.7500	33.338 1.3125	20.6 0.81	3.5 0.14	247.0 9.72	254.0 10.00	3.3 0.13	309.0 12.17	299.0 11.77	4.8 0.18	1.1 0.05	800.1	189.1	0.1352	9.36 20.61
44.450 1.7500	33.338 1.3125	20.6 0.81	3.5 0.14	248.0 9.76	253.0 9.96	3.3 0.13	309.0 12.17	299.0 11.77	4.8 0.18	1.1 0.05	800.1	189.1	0.1352	9.25 20.39
65.088 2.5625	50.800 2.0000	-4.8 -0.19	6.4 0.25	253.0 9.96	262.0 10.31	3.3 0.13	322.0 12.68	313.0 12.32	5.1 0.20	3.3 0.13	1354.6	198.0	0.1436	17.49 38.54
69.850 2.7500	50.800 2.0000	-4.8 -0.19	6.4 0.25	253.0 9.96	263.0 10.35	3.3 0.13	322.0 12.68	313.0 12.32	4.2 0.16	1.2 0.05	1264.4	185.4	0.1401	17.83 39.30
71.438 2.8125	53.975 2.1250	-6.9 -0.27	6.4 0.25	258.0 10.16	267.0 10.51	3.3 0.13	343.0 13.50	335.0 13.19	8.0 0.31	3.1 0.12	1626.0	173.0	0.1526	24.91 54.91
39.000 1.5354	30.000 1.1811	19.6 0.77	3.0 0.12	252.0 9.92	257.0 10.12	3.0 0.12	310.0 12.20	304.0 11.97	4.7 0.18	4.6 0.18	804.0	198.2	0.1326	8.24 18.17
68.262 2.6875	53.975 2.1250	-2.3 -0.09	6.4 0.25	257.0 10.12	269.0 10.59	3.3 0.13	343.9 13.54	341.1 13.43	7.7 0.30	0.2 0.01	1309.0	221.1	0.1432	24.45 53.90
52.388 2.0625	36.512 1.4375	7.6 0.30	6.4 0.25	253.0 9.96	264.0 10.39	3.3 0.13	313.0 12.32	305.0 12.01	7.0 0.27	2.2 0.09	1050.5	172.4	0.1401	11.34 25.01
57.150 2.2500	44.450 1.7500	2.5 0.10	6.4 0.25	257.0 10.12	267.0 10.51	3.3 0.13	329.0 12.95	325.0 12.80	6.4 0.25	1.7 0.07	1178.6	164.4	0.1392	16.53 36.44
57.150 2.2500	44.450 1.7500	2.5 0.10	6.4 0.25	257.0 10.12	267.0 10.51	3.3 0.13	329.0 12.95	327.0 12.87	6.4 0.25	1.7 0.07	1178.6	164.4	0.1392	17.75 39.13
50.800 2.0000	33.338 1.3125	5.8 0.23	6.4 0.25	260.0 10.24	269.0 10.59	3.3 0.13	337.0 13.27	334.0 13.15	8.6 0.33	3.3 0.13	1068.6	171.6	0.1354	15.42 33.98
57.150 2.2500	44.450 1.7500	2.5 0.10	6.4 0.25	257.0 10.12	267.0 10.51	3.3 0.13	329.0 12.95	327.0 12.87	6.4 0.25	1.7 0.07	1178.6	164.4	0.1392	17.77 39.18
50.800 2.0000	33.338 1.3125	5.8 0.23	6.4 0.25	260.0 10.24	269.0 10.59	3.3 0.13	337.0 13.27	338.0 13.31	8.6 0.33	3.3 0.13	1068.6	171.6	0.1354	16.81 37.05
50.800 2.0000	33.338 1.3125	5.8 0.23	6.4 0.25	260.0 10.24	269.0 10.59	3.3 0.13	337.0 13.27	340.0 13.39	8.6 0.33	3.3 0.13	1068.6	171.6	0.1354	17.30 38.12

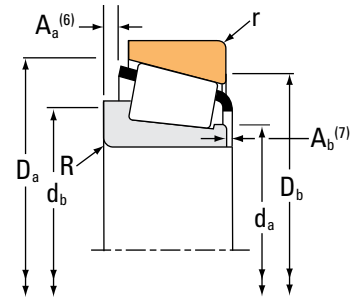
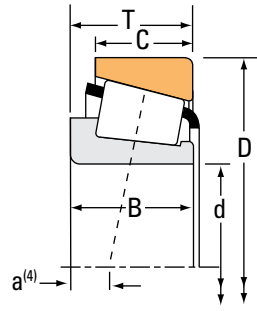
<sup>(4)</sup>Negative value indicates effective center inside cone (inner-ring) backface.  
<sup>(5)</sup>These maximum fillet radii will be cleared by the bearing corners.  
<sup>(6)</sup>Negative value indicates cage extends beyond cone (inner-ring) backface.  
<sup>(7)</sup>Negative value indicates cage that does not extend beyond cone (inner-ring) front face.

Continued on next page.

# TAPERED ROLLER BEARINGS

## SINGLE-ROW • TYPE TS

### TYPE TS



Bearing Dimensions			Load Ratings							Part Number		
Bore d	O.D. D	Width T	Dynamic <sup>(1)</sup>		Factors <sup>(2)</sup>		Dynamic <sup>(3)</sup>		Factors <sup>(2)</sup>	Static	Inner	Outer
			C <sub>1</sub>	e	Y	C <sub>90</sub>	C <sub>a90</sub>	K	C <sub>0</sub>			
mm in.	mm in.	mm in.	N lbf			N lbf	N lbf			N lbf		
241.300 9.5000	368.300 14.5000	68.262 2.6875	844000 190000	0.34	1.75	219000 49200	129000 28900	1.70		1530000 345000	EE125095	125145
241.300 9.5000	393.700 15.5000	73.817 2.9062	1010000 228000	0.40	1.49	262000 59000	181000 40600	1.45		1600000 359000	EE275095	275155
241.300 9.5000	403.225 15.8750	69.850 2.7500	1010000 228000	0.40	1.49	262000 59000	181000 40600	1.45		1600000 359000	EE275095	275158
241.300 9.5000	406.400 16.0000	69.850 2.7500	1010000 228000	0.40	1.49	262000 59000	181000 40600	1.45		1600000 359000	EE275095	275160
241.300 9.5000	444.500 17.5000	101.600 4.0000	1820000 409000	0.34	1.78	472000 106000	273000 61300	1.73		2420000 544000	EE923095	923175
241.300 9.5000	488.950 19.2500	120.650 4.7500	2420000 544000	0.31	1.92	628000 141000	336000 75600	1.87		3310000 744000	EE295950	295193
241.300 9.5000	508.000 20.0000	117.475 4.6250	1430000 322000	0.94	0.64	371000 83500	596000 134000	0.62		2100000 473000	EE390095	390200
243.683 9.5938	315.912 12.4375	31.750 1.2500	270000 60700	0.43	1.39	70000 15700	51500 11600	1.36		561000 126000	LL648434	LL648415
244.475 9.6250	381.000 15.0000	79.375 3.1250	907000 204000	0.52	1.16	235000 52900	208000 46800	1.13		1690000 381000	EE126097	126150
247.650 9.7500	304.800 12.0000	22.225 0.8750	157000 35400	0.32	1.85	40800 9170	22700 5100	1.80		373000 83900	28880	28820
247.650 9.7500	346.075 13.6250	63.500 2.5000	850000 191000	0.34	1.75	220000 49500	130000 29100	1.70		1620000 365000	M348449	M348410
247.650 9.7500	355.600 14.0000	50.800 2.0000	643000 144000	0.36	1.65	167000 37500	104000 23300	1.61		1030000 231000	EE170975	171400
247.650 9.7500	365.049 14.3720	50.800 2.0000	643000 144000	0.36	1.65	167000 37500	104000 23300	1.61		1030000 231000	EE170975	171436
247.650 9.7500	368.300 14.5000	50.800 2.0000	643000 144000	0.36	1.65	167000 37500	104000 23300	1.61		1030000 231000	EE170975	171450
247.650 9.7500	381.000 15.0000	74.612 2.9375	1150000 258000	0.33	1.80	298000 67000	170000 38100	1.76		2030000 455000	M252337	M252310
247.650 9.7500	406.400 16.0000	115.887 4.5625	2470000 554000	0.33	1.80	639000 144000	364000 81800	1.76		3770000 846000	HH249949H	HH249910
247.650 9.7500	406.400 16.0000	115.888 4.5625	2080000 468000	0.33	1.80	539000 121000	307000 69000	1.76		3770000 846000	HH249949	HH249910

<sup>(1)</sup>Based on 1 x 10<sup>6</sup> revolutions L<sub>10</sub> life, for the ISO life-calculation method.

<sup>(2)</sup>Consult your Timken engineer for instructions on use or review the Timken Engineering Manual on timken.com/catalogs.

<sup>(3)</sup>Based on 90 x 10<sup>6</sup> revolutions L<sub>10</sub> life, for The Timken Company life-calculation method. C<sub>90</sub> and C<sub>a90</sub> are radial and thrust values.



Bearing Dimensions											Geometry Factors			Bearing Weight
Width B	Width C	Eff. Ctr. a <sup>(4)</sup>	Shaft			Housing			Cage		G <sub>1</sub>	G <sub>2</sub>	C <sub>g</sub>	
			Max Shaft Fillet Radius R <sup>(5)</sup>	Backing Shoulder Dia. d <sub>a</sub>	Shoulder Dia. d <sub>b</sub>	Max Housing Fillet Radius r <sup>(5)</sup>	Backing Shoulder Dia. D <sub>a</sub>	Shoulder Dia. D <sub>b</sub>	A <sub>a</sub> <sup>(6)</sup>	A <sub>b</sub> <sup>(7)</sup>				
mm in.	mm in.	mm in.	mm in.	mm in.	mm in.	mm in.	mm in.	mm in.	mm in.	mm in.				kg lbs.
68.262 2.6875	53.975 2.1250	-2.3 -0.09	6.4 0.25	257.0 10.12	269.0 10.59	3.3 0.13	343.9 13.54	341.1 13.43	7.7 0.30	0.2 0.01	1309.0	221.1	0.1432	24.12 53.18
69.850 2.7500	50.005 1.9687	2.5 0.10	6.4 0.25	268.0 10.55	278.0 10.94	6.4 0.25	378.1 14.89	366.0 14.41	14.4 0.56	3.3 0.13	1451.8	201.3	0.1555	31.91 70.36
69.850 2.7500	46.038 1.8125	2.5 0.10	6.4 0.25	268.0 10.55	278.0 10.94	6.4 0.25	378.1 14.89	371.0 14.61	14.4 0.56	3.3 0.13	1451.8	201.3	0.1555	33.30 73.41
69.850 2.7500	46.038 1.8125	2.5 0.10	6.4 0.25	268.0 10.55	278.0 10.94	6.4 0.25	378.5 14.90	373.0 14.69	14.4 0.56	3.3 0.13	1451.8	201.3	0.1555	34.15 75.30
100.012 3.9375	76.200 3.0000	-19.3 -0.76	6.4 0.25	268.0 10.55	277.0 10.91	4.8 0.19	407.0 16.02	403.0 15.87	12.2 0.48	2.1 0.09	1626.7	136.5	0.1531	65.65 144.73
120.650 4.7500	92.075 3.6250	-31.0 -1.22	6.4 0.25	276.0 10.87	285.0 11.22	6.4 0.25	450.5 17.74	444.0 17.48	18.6 0.73	4.0 0.16	2247.3	171.9	0.1664	103.07 227.24
95.250 3.7500	73.025 2.8750	49.5 1.95	6.4 0.25	288.0 11.34	297.0 11.69	6.4 0.25	456.2 17.96	423.0 16.65	22.4 0.88	18.9 0.75	1258.2	106.2	0.1909	94.79 208.97
31.750 1.2500	22.225 0.8750	22.4 0.88	3.5 0.14	254.0 10.00	260.0 10.24	3.3 0.13	305.0 12.01	300.0 11.81	4.6 0.18	1.5 0.06	817.0	322.2	0.1295	5.84 12.89
76.200 3.0000	57.150 2.2500	9.7 0.38	6.4 0.25	266.0 10.47	275.0 10.83	4.8 0.19	358.0 14.09	343.0 13.50	13.0 0.51	2.0 0.08	1321.8	168.9	0.1640	30.34 66.87
22.225 0.8750	15.875 0.6250	17.3 0.68	1.5 0.06	256.0 10.08	258.0 10.16	1.5 0.06	294.0 11.57	291.0 11.46	1.6 0.06	1.9 0.08	807.0	572.7	0.1479	3.18 7.01
63.500 2.5000	50.800 2.0000	-1.3 -0.05	6.4 0.25	263.0 10.35	273.0 10.75	6.4 0.25	332.0 13.07	321.0 12.64	4.0 0.15	3.7 0.15	1450.8	212.9	0.1483	17.60 38.81
50.800 2.0000	33.338 1.3125	5.8 0.23	6.4 0.25	264.0 10.39	274.0 10.79	3.3 0.13	337.0 13.27	334.0 13.15	8.6 0.33	3.3 0.13	1068.6	171.6	0.1354	14.44 31.83
50.800 2.0000	33.338 1.3125	5.8 0.23	6.4 0.25	264.0 10.39	274.0 10.79	3.3 0.13	337.0 13.27	338.0 13.31	8.6 0.33	3.3 0.13	1068.6	171.6	0.1354	15.83 34.90
50.800 2.0000	33.338 1.3125	5.8 0.23	6.4 0.25	264.0 10.39	274.0 10.79	3.3 0.13	337.0 13.27	340.0 13.39	8.6 0.33	3.3 0.13	1068.6	171.6	0.1354	16.32 35.98
74.612 2.9375	57.150 2.2500	-6.6 -0.26	6.4 0.25	270.0 10.63	280.0 11.02	3.3 0.13	364.0 14.32	356.0 14.02	8.3 0.32	3.6 0.14	1839.2	226.1	0.1588	30.51 67.25
117.475 4.6250	93.662 3.6875	-28.7 -1.13	6.4 0.25	278.0 10.94	288.0 11.34	6.4 0.25	383.0 15.08	366.0 14.41	8.9 0.35	4.1 0.16	2373.9	173.3	0.1746	60.55 133.51
117.475 4.6250	93.662 3.6875	-28.7 -1.13	6.4 0.25	275.0 10.83	284.0 11.18	6.4 0.25	383.0 15.08	366.0 14.41	8.9 0.35	4.1 0.16	2373.9	173.3	0.1746	60.60 133.60

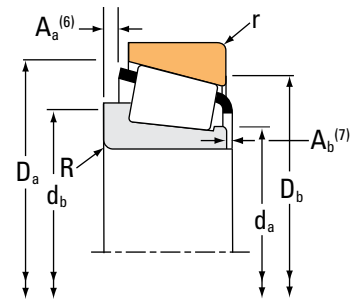
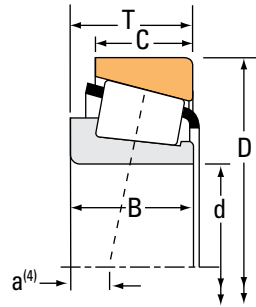
(4) Negative value indicates effective center inside cone (inner-ring) backface.  
 (5) These maximum fillet radii will be cleared by the bearing corners.  
 (6) Negative value indicates cage extends beyond cone (inner-ring) backface.  
 (7) Negative value indicates cage that does not extend beyond cone (inner-ring) front face.

Continued on next page.

# TAPERED ROLLER BEARINGS

## SINGLE-ROW • TYPE TS

### TYPE TS



Bearing Dimensions			Load Ratings							Part Number		
Bore d	O.D. D	Width T	Dynamic <sup>(1)</sup> C <sub>1</sub>		Factors <sup>(2)</sup> e Y		Dynamic <sup>(3)</sup> C <sub>90</sub> C <sub>a90</sub>		Factors <sup>(2)</sup> K	Static C <sub>0</sub>	Inner	Outer
mm in.	mm in.	mm in.	N lbf				N lbf	N lbf		N lbf		
247.650 9.7500	444.500 17.5000	139.700 5.5000	3130000 705000	0.29	2.06		813000 183000	406000 91200	2.00	4470000 1000000	NP544119	NP225734
249.250 9.8130	381.000 15.0000	79.375 3.1250	907000 204000	0.52	1.16		235000 52900	208000 46800	1.13	1690000 381000	EE126098	126150
254.000 10.0000	315.912 12.4375	31.750 1.2500	255000 57300	0.43	1.39		66100 14900	48700 10900	1.36	561000 126000	LL648449	LL648415
254.000 10.0000	315.912 12.4375	31.750 1.2500	255000 57300	0.43	1.39		66100 14900	48700 10900	1.36	561000 126000	LL648449	LL648416
254.000 10.0000	323.850 12.7500	22.225 0.8750	151000 33900	0.35	1.73		39200 8800	23200 5220	1.69	391000 87800	29875	29820
254.000 10.0000	358.775 14.1250	71.438 2.8125	914000 206000	0.33	1.80		237000 53300	135000 30300	1.76	1850000 416000	M249749	M249710
254.000 10.0000	358.775 14.1250	71.438 2.8125	1150000 258000	0.33	1.80		297000 66900	169000 38100	1.76	1850000 416000	M249749H	M249710X
254.000 10.0000	358.775 14.1250	71.438 2.8125	914000 206000	0.33	1.80		237000 53300	135000 30300	1.76	1850000 416000	M249749X	M249710
254.000 10.0000	365.125 14.3750	58.738 2.3125	679000 153000	0.37	1.60		176000 39600	113000 25400	1.56	1330000 299000	EE134100	134143
254.000 10.0000	368.300 14.5000	58.738 2.3125	679000 153000	0.37	1.60		176000 39600	113000 25400	1.56	1330000 299000	EE134100	134145
254.000 10.0000	393.700 15.5000	73.817 2.9062	1010000 228000	0.40	1.49		262000 59000	181000 40600	1.45	1600000 359000	EE275100	275155
254.000 10.0000	400.050 15.7500	57.150 2.2500	782000 176000	0.33	1.81		203000 45600	115000 25900	1.76	1390000 313000	EE251001	251575
254.000 10.0000	403.225 15.8750	69.850 2.7500	1010000 228000	0.40	1.49		262000 59000	181000 40600	1.45	1600000 359000	EE275100	275158
254.000 10.0000	406.400 16.0000	69.850 2.7500	1010000 228000	0.40	1.49		262000 59000	181000 40600	1.45	1600000 359000	EE275100	275160
254.000 10.0000	422.275 16.6250	86.121 3.3906	1550000 348000	0.33	1.80		401000 90100	228000 51300	1.76	2110000 475000	HM252344	HM252310
254.000 10.0000	422.275 16.6250	86.121 3.3906	1500000 337000	0.33	1.80		389000 87400	221000 49700	1.76	2020000 455000	HM252343	HM252310
254.000 10.0000	431.724 16.9970	82.550 3.2500	1500000 337000	0.33	1.80		389000 87400	221000 49700	1.76	2020000 455000	HM252343	HM252315

<sup>(1)</sup>Based on 1 x 10<sup>6</sup> revolutions L<sub>10</sub> life, for the ISO life-calculation method.

<sup>(2)</sup>Consult your Timken engineer for instructions on use or review the Timken Engineering Manual on timken.com/catalogs.

<sup>(3)</sup>Based on 90 x 10<sup>6</sup> revolutions L<sub>10</sub> life, for The Timken Company life-calculation method. C<sub>90</sub> and C<sub>a90</sub> are radial and thrust values.

Bearing Dimensions											Geometry Factors			Bearing Weight
Width B	Width C	Eff. Ctr. a <sup>(4)</sup>	Shaft			Housing			Cage		G <sub>1</sub>	G <sub>2</sub>	C <sub>g</sub>	
			Max Shaft Fillet Radius R <sup>(5)</sup>	Backing Shoulder Dia. d <sub>a</sub> d <sub>b</sub>		Max Housing Fillet Radius r <sup>(5)</sup>	Backing Shoulder Dia. D <sub>a</sub> D <sub>b</sub>		A <sub>a</sub> <sup>(6)</sup>	A <sub>b</sub> <sup>(7)</sup>				
mm in.	mm in.	mm in.	mm in.	mm in.	mm in.	mm in.	mm in.	mm in.	mm in.	mm in.				kg lbs.
139.700 5.5000	120.650 4.7500	-41.7 -1.64	6.4 0.25	281.0 11.06	291.0 11.46	6.4 0.25	413.5 16.28	396.0 15.59	8.3 0.32	5.2 0.21	2724.6	139.8	0.1748	96.14 211.94
76.200 3.0000	57.150 2.2500	9.7 0.38	6.4 0.25	269.0 10.59	279.0 10.98	4.8 0.19	358.0 14.09	343.0 13.50	13.0 0.51	2.0 0.08	1321.8	168.9	0.1640	29.23 64.44
31.750 1.2500	22.225 0.8750	22.4 0.88	3.5 0.14	262.0 10.31	268.0 10.55	3.3 0.13	305.0 12.01	300.0 11.81	4.6 0.18	1.5 0.06	817.0	322.2	0.1295	4.84 10.68
31.750 1.2500	22.225 0.8750	22.4 0.88	3.5 0.14	262.0 10.31	268.0 10.55	4.8 0.19	305.0 12.01	298.0 11.73	4.6 0.18	1.5 0.06	817.0	322.2	0.1295	4.80 10.57
22.225 0.8750	15.875 0.6250	21.1 0.83	1.5 0.06	266.0 10.47	267.0 10.51	1.5 0.06	312.0 12.28	310.0 12.20	1.7 0.06	1.9 0.08	906.8	658.2	0.1567	4.27 9.40
71.438 2.8125	53.975 2.1250	-6.9 -0.27	3.5 0.14	270.0 10.63	274.0 10.79	3.3 0.13	343.0 13.50	335.0 13.19	8.0 0.31	3.1 0.12	1626.0	173.0	0.1526	21.39 47.16
71.438 2.8125	53.975 2.1250	-6.9 -0.27	3.5 0.14	272.0 10.71	276.0 10.87	3.3 0.13	343.0 13.50	335.0 13.19	7.9 0.31	3.1 0.13	1626.0	173.0	0.1526	21.69 47.82
71.438 2.8125	53.975 2.1250	-6.9 -0.27	3.5 0.14	270.0 10.63	274.0 10.79	3.3 0.13	343.0 13.50	335.0 13.19	8.0 0.31	3.1 0.12	1626.0	173.0	0.1526	21.42 47.22
58.738 2.3125	42.862 1.6875	5.1 0.20	6.4 0.25	272.0 10.71	281.0 11.06	6.4 0.25	347.0 13.66	339.0 13.35	8.2 0.32	1.7 0.07	1327.7	187.2	0.1474	18.23 40.20
58.738 2.3125	42.862 1.6875	5.1 0.20	6.4 0.25	272.0 10.71	281.0 11.06	6.4 0.25	347.0 13.66	340.0 13.39	8.2 0.32	1.7 0.07	1327.7	187.2	0.1474	18.85 41.55
69.850 2.7500	50.005 1.9687	2.5 0.10	6.4 0.25	277.0 10.91	287.0 11.30	6.4 0.25	378.1 14.89	366.0 14.41	14.4 0.56	3.3 0.13	1451.8	201.3	0.1555	29.21 64.40
55.562 2.1875	41.275 1.6250	3.3 0.13	3.3 0.13	272.0 10.71	278.0 10.94	1.5 0.06	369.0 14.53	371.0 14.61	6.3 0.24	5.4 0.21	1323.1	218.0	0.1413	24.94 54.95
69.850 2.7500	46.038 1.8125	2.5 0.10	6.4 0.25	277.0 10.91	287.0 11.30	6.4 0.25	378.1 14.89	371.0 14.61	14.4 0.56	3.3 0.13	1451.8	201.3	0.1555	30.60 67.45
69.850 2.7500	46.038 1.8125	2.5 0.10	6.4 0.25	277.0 10.91	287.0 11.30	6.4 0.25	378.5 14.90	373.0 14.69	14.4 0.56	3.3 0.13	1451.8	201.3	0.1555	31.45 69.34
79.771 3.1406	66.675 2.6250	-9.4 -0.37	6.8 0.27	281.0 11.06	287.0 11.30	3.3 0.13	399.5 15.73	392.0 15.43	10.4 0.41	6.1 0.24	1551.8	152.3	0.1498	44.32 97.70
79.771 3.1406	66.675 2.6250	-9.4 -0.37	6.8 0.27	281.0 11.06	287.0 11.30	3.3 0.13	399.5 15.73	392.0 15.43	12.9 0.51	4.8 0.19	1504.3	147.8	0.1482	42.03 92.64
79.771 3.1406	60.325 2.3750	-9.4 -0.37	6.8 0.27	281.0 11.06	287.0 11.30	3.5 0.14	398.3 15.68	397.0 15.63	12.9 0.51	4.8 0.19	1504.3	147.8	0.1482	43.71 96.35

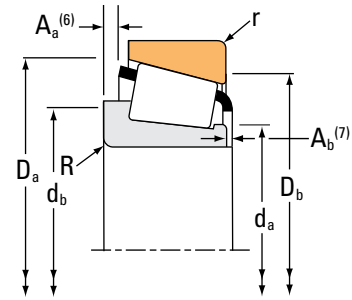
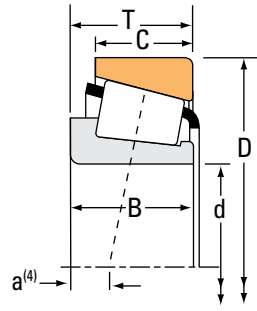
<sup>(4)</sup>Negative value indicates effective center inside cone (inner-ring) backface.  
<sup>(5)</sup>These maximum fillet radii will be cleared by the bearing corners.  
<sup>(6)</sup>Negative value indicates cage extends beyond cone (inner-ring) backface.  
<sup>(7)</sup>Negative value indicates cage that does not extend beyond cone (inner-ring) front face.

Continued on next page.

# TAPERED ROLLER BEARINGS

## SINGLE-ROW • TYPE TS

### TYPE TS



Bearing Dimensions			Load Ratings							Part Number		
Bore d	O.D. D	Width T	Dynamic <sup>(1)</sup> C <sub>1</sub>		Factors <sup>(2)</sup> e Y		Dynamic <sup>(3)</sup> C <sub>90</sub> C <sub>a90</sub>		Factors <sup>(2)</sup> K	Static C <sub>0</sub>	Inner	Outer
mm in.	mm in.	mm in.	N lbf				N lbf	N lbf		N lbf		
254.000 10.0000	444.500 17.5000	76.200 3.0000	1180000 264000	0.34	1.76		305000 68500	178000 40000	1.71	1740000 392000	EE822100	822175
254.000 10.0000	495.300 19.5000	76.200 3.0000	1550000 348000	0.40	1.49		402000 90300	277000 62200	1.45	2090000 471000	EE941002	941950
254.000 10.0000	495.300 19.5000	141.288 5.5625	2870000 645000	0.33	1.80		744000 167000	423000 95200	1.76	5650000 1270000	HH258232	HH258210
254.000 10.0000	533.400 21.0000	133.350 5.2500	2680000 603000	0.94	0.64		696000 156000	1120000 251000	0.62	3090000 694000	HH953749	HH953710
254.000 10.0000	533.400 21.0000	133.350 5.2500	2680000 603000	0.94	0.64		696000 156000	1120000 251000	0.62	3090000 694000	HH953749	HH953710X
254.000 10.0000	558.800 22.0000	123.825 4.8750	1800000 404000	0.87	0.69		466000 105000	691000 155000	0.67	2680000 603000	EE620100	620220
257.175 10.1250	342.900 13.5000	57.150 2.2500	780000 175000	0.35	1.73		202000 45500	120000 27000	1.68	1430000 321000	M349549	M349510
257.175 10.1250	342.900 13.5000	57.150 2.2500	780000 175000	0.35	1.73		202000 45500	120000 27000	1.68	1430000 321000	M349549A	M349510
258.762 10.1875	400.050 15.7500	69.850 2.7500	949000 213000	0.39	1.52		246000 55300	166000 37400	1.48	1450000 326000	EE221018	221575
260.350 10.2500	365.125 14.3750	58.738 2.3125	679000 153000	0.37	1.60		176000 39600	113000 25400	1.56	1330000 299000	EE134102	134143
260.350 10.2500	368.300 14.5000	58.738 2.3125	679000 153000	0.37	1.60		176000 39600	113000 25400	1.56	1330000 299000	EE134102	134145
260.350 10.2500	400.050 15.7500	69.850 2.7500	949000 213000	0.39	1.52		246000 55300	166000 37400	1.48	1450000 326000	EE221026	221575
260.350 10.2500	406.400 16.0000	69.850 2.7500	924000 208000	0.39	1.55		240000 53900	158000 35600	1.51	1820000 409000	EE128102	128160
260.350 10.2500	419.100 16.5000	85.725 3.3750	1120000 253000	0.60	0.99		291000 65500	302000 67800	0.97	2010000 451000	EE435102	435165
260.350 10.2500	422.275 16.6250	86.121 3.3906	1550000 348000	0.33	1.80		401000 90100	228000 51300	1.76	2110000 475000	HM252349	HM252310
260.350 10.2500	422.275 16.6250	86.121 3.3906	1500000 337000	0.33	1.80		389000 87400	221000 49700	1.76	2020000 455000	HM252348	HM252310
260.350 10.2500	431.724 16.9970	82.550 3.2500	1500000 337000	0.33	1.80		389000 87400	221000 49700	1.76	2020000 455000	HM252348	HM252315

<sup>(1)</sup>Based on 1 x 10<sup>6</sup> revolutions L<sub>10</sub> life, for the ISO life-calculation method.

<sup>(2)</sup>Consult your Timken engineer for instructions on use or review the Timken Engineering Manual on timken.com/catalogs.

<sup>(3)</sup>Based on 90 x 10<sup>6</sup> revolutions L<sub>10</sub> life, for The Timken Company life-calculation method. C<sub>90</sub> and C<sub>a90</sub> are radial and thrust values.

Bearing Dimensions											Geometry Factors			Bearing Weight
Width B	Width C	Eff. Ctr. a <sup>(4)</sup>	Shaft			Housing			Cage		G <sub>1</sub>	G <sub>2</sub>	C <sub>g</sub>	
			Max Shaft Fillet Radius R <sup>(5)</sup>	Backing Shoulder Dia. d <sub>a</sub>	mm in.	Max Housing Fillet Radius r <sup>(5)</sup>	Backing Shoulder Dia. D <sub>a</sub>	mm in.	A <sub>a</sub> <sup>(6)</sup>	A <sub>b</sub> <sup>(7)</sup>				
mm in.	mm in.	mm in.	mm in.	mm in.	mm in.	mm in.	mm in.	mm in.	mm in.	mm in.			kg lbs.	
73.025 2.8750	50.800 2.0000	-5.3 -0.21	6.4 0.25	276.1 10.87	288.0 11.34	6.4 0.25	407.9 16.06	404.9 15.94	12.1 0.47	6.5 0.26	1363.4	186.1	0.1442	43.84 96.65
74.612 2.9375	53.975 2.1250	9.1 0.36	6.4 0.25	292.0 11.50	301.0 11.85	3.3 0.13	462.7 18.22	459.0 18.07	10.2 0.40	6.0 0.24	1771.6	187.4	0.1657	64.61 142.44
141.288 5.5625	114.300 4.5000	-34.5 -1.36	6.4 0.25	295.0 11.61	304.0 11.97	6.4 0.25	467.0 18.40	448.0 17.64	10.6 0.42	7.5 0.30	3853.2	220.0	0.2048	132.43 291.94
120.650 4.7500	77.788 3.0625	45.5 1.79	6.4 0.25	306.3 12.06	328.0 12.91	6.4 0.25	495.6 19.51	455.0 17.91	21.8 0.86	14.3 0.56	1668.7	104.2	0.2101	127.31 280.67
120.650 4.7500	77.788 3.0625	45.5 1.79	6.4 0.25	306.3 12.06	328.0 12.91	6.4 0.25	495.6 19.51	455.0 17.91	21.8 0.86	14.3 0.56	1668.7	104.2	0.2101	127.09 280.20
104.775 4.1250	69.850 2.7500	48.8 1.92	8.0 0.31	308.0 12.13	317.0 12.48	8.0 0.31	501.9 19.76	477.0 18.78	23.9 0.94	17.5 0.69	1730.9	165.3	0.2078	126.87 279.70
57.150 2.2500	44.450 1.7500	2.5 0.10	6.4 0.25	269.0 10.59	281.0 11.06	3.3 0.13	333.0 13.11	322.0 12.68	4.7 0.18	3.0 0.12	1423.3	193.4	0.1475	13.71 30.22
57.150 2.2500	44.450 1.7500	2.5 0.10	10.7 0.42	269.0 10.59	289.0 11.38	3.3 0.13	333.0 13.11	322.0 12.68	4.7 0.18	3.0 0.12	1423.3	193.4	0.1475	13.40 29.53
67.470 2.6563	46.038 1.8125	0.8 0.03	9.7 0.38	279.0 10.98	295.0 11.61	6.4 0.25	371.5 14.63	366.0 14.41	14.3 0.56	5.6 0.22	1320.8	207.5	0.1497	27.08 59.72
58.738 2.3125	42.862 1.6875	5.1 0.20	6.4 0.25	276.0 10.87	286.0 11.26	6.4 0.25	347.0 13.66	339.0 13.35	8.2 0.32	1.7 0.07	1327.7	187.2	0.1474	17.00 37.50
58.738 2.3125	42.862 1.6875	5.1 0.20	6.4 0.25	276.0 10.87	286.0 11.26	6.4 0.25	347.0 13.66	340.0 13.39	8.2 0.32	1.7 0.07	1327.7	187.2	0.1474	17.62 38.85
67.470 2.6563	46.038 1.8125	0.8 0.03	9.7 0.38	280.0 11.02	296.0 11.65	6.4 0.25	371.5 14.63	366.0 14.41	14.3 0.56	5.6 0.22	1320.8	207.5	0.1497	26.74 58.97
67.673 2.6643	53.975 2.1250	6.6 0.26	3.3 0.13	292.0 11.50	288.0 11.34	3.3 0.13	384.0 15.12	378.0 14.88	6.8 0.27	2.1 0.08	1727.7	255.2	0.1628	32.57 71.80
84.138 3.3125	61.912 2.4375	19.8 0.78	6.4 0.25	285.0 11.22	295.0 11.61	3.3 0.13	395.1 15.56	376.0 14.80	14.0 0.55	2.0 0.08	1480.2	123.2	0.1787	41.85 92.26
79.771 3.1406	66.675 2.6250	-9.4 -0.37	6.8 0.27	285.0 11.22	292.0 11.50	3.3 0.13	399.5 15.73	392.0 15.43	10.4 0.41	6.1 0.24	1551.8	152.3	0.1498	42.72 94.17
79.771 3.1406	66.675 2.6250	-9.4 -0.37	6.8 0.27	285.0 11.22	292.0 11.50	3.3 0.13	399.5 15.73	392.0 15.43	12.9 0.51	4.8 0.19	1504.3	147.8	0.1482	40.54 89.36
79.771 3.1406	60.325 2.3750	-9.4 -0.37	6.8 0.27	285.0 11.22	292.0 11.50	3.5 0.14	398.3 15.68	397.0 15.63	12.9 0.51	4.8 0.19	1504.3	147.8	0.1482	42.22 93.07

<sup>(4)</sup>Negative value indicates effective center inside cone (inner-ring) backface.

<sup>(5)</sup>These maximum fillet radii will be cleared by the bearing corners.

<sup>(6)</sup>Negative value indicates cage extends beyond cone (inner-ring) backface.

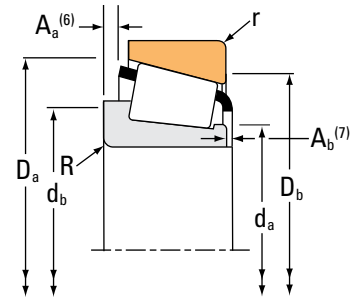
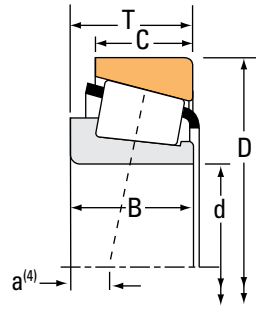
<sup>(7)</sup>Negative value indicates cage that does not extend beyond cone (inner-ring) front face.

Continued on next page.

# TAPERED ROLLER BEARINGS

## SINGLE-ROW • TYPE TS

### TYPE TS



Bearing Dimensions			Load Ratings							Part Number		
Bore d	O.D. D	Width T	Dynamic <sup>(1)</sup>		Factors <sup>(2)</sup>		Dynamic <sup>(3)</sup>		Factors <sup>(2)</sup>	Static	Inner	Outer
			C <sub>1</sub>	e	Y	C <sub>90</sub>	C <sub>a90</sub>	K	C <sub>0</sub>			
mm in.	mm in.	mm in.	N lbf			N lbf	N lbf			N lbf		
260.350 10.2500	431.724 16.9970	82.550 3.2500	1550000 348000	0.33	1.80	401000 90100	228000 51300	1.76		2110000 475000	HM252349	HM252315
260.350 10.2500	488.950 19.2500	120.650 4.7500	2420000 544000	0.31	1.92	628000 141000	336000 75600	1.87		3310000 744000	EE295102	295193
263.525 10.3750	325.438 12.8125	28.575 1.1250	221000 49800	0.37	1.64	57400 12900	35900 8080	1.60		554000 125000	38880	38820
263.525 10.3750	355.600 14.0000	57.150 2.2500	805000 181000	0.36	1.67	209000 46900	129000 28900	1.62		1510000 339000	LM451345	LM451310
264.975 10.4321	355.600 14.0000	57.150 2.2500	731000 164000	0.36	1.67	189000 42600	117000 26300	1.62		1310000 296000	LM451347	LM451310
266.560 10.4945	325.438 12.8125	29.500 1.1614	217000 48800	0.37	1.64	56300 12700	35300 7930	1.60		507000 114000	LL450748A	38820
266.560 10.4945	325.438 12.8125	29.500 1.1614	214000 48100	0.37	1.64	55500 12500	34700 7810	1.60		527000 118000	38884	38820
266.700 10.5000	323.850 12.7500	22.225 0.8750	151000 33900	0.35	1.73	39200 8800	23200 5220	1.69		391000 87800	29880	29820
266.700 10.5000	325.438 12.8125	28.575 1.1250	221000 49800	0.37	1.64	57400 12900	35900 8080	1.60		554000 125000	38885	38820
266.700 10.5000	325.438 12.8125	29.500 1.1614	230000 51700	0.37	1.64	59600 13400	37300 8390	1.60		507000 114000	LL450749AA	38820
266.700 10.5000	325.438 12.8125	29.500 1.1614	227000 50900	0.37	1.64	58700 13200	36800 8260	1.60		527000 118000	38886	38820
266.700 10.5000	355.600 14.0000	57.150 2.2500	880000 198000	0.36	1.67	228000 51300	141000 31600	1.62		1510000 339000	LM451349	LM451310
266.700 10.5000	355.600 14.0000	57.150 2.2500	805000 181000	0.36	1.67	209000 46900	129000 28900	1.62		1510000 339000	LM451349A	LM451310
266.700 10.5000	355.600 14.0000	57.150 2.2500	805000 181000	0.36	1.67	209000 46900	129000 28900	1.62		1510000 339000	LM451349AX	LM451310
266.700 10.5000	393.700 15.5000	73.817 2.9062	1010000 228000	0.40	1.49	262000 59000	181000 40600	1.45		1600000 359000	EE275105	275155
266.700 10.5000	403.225 15.8750	69.850 2.7500	1010000 228000	0.40	1.49	262000 59000	181000 40600	1.45		1600000 359000	EE275105	275158
266.700 10.5000	406.400 16.0000	69.850 2.7500	1010000 228000	0.40	1.49	262000 59000	181000 40600	1.45		1600000 359000	EE275105	275160

<sup>(1)</sup>Based on 1 x 10<sup>6</sup> revolutions L<sub>10</sub> life, for the ISO life-calculation method.

<sup>(2)</sup>Consult your Timken engineer for instructions on use or review the Timken Engineering Manual on timken.com/catalogs.

<sup>(3)</sup>Based on 90 x 10<sup>6</sup> revolutions L<sub>10</sub> life, for The Timken Company life-calculation method. C<sub>90</sub> and C<sub>a90</sub> are radial and thrust values.

Bearing Dimensions											Geometry Factors			Bearing Weight
Width B	Width C	Eff. Ctr. a <sup>(4)</sup>	Shaft			Housing			Cage		G <sub>1</sub>	G <sub>2</sub>	C <sub>g</sub>	
			Max Shaft Fillet Radius R <sup>(5)</sup>	Backing Shoulder Dia. d <sub>a</sub>	Shoulder Dia. d <sub>b</sub>	Max Housing Fillet Radius r <sup>(5)</sup>	Backing Shoulder Dia. D <sub>a</sub>	Shoulder Dia. D <sub>b</sub>	A <sub>a</sub> <sup>(6)</sup>	A <sub>b</sub> <sup>(7)</sup>				
mm in.	mm in.	mm in.	mm in.	mm in.	mm in.	mm in.	mm in.	mm in.	mm in.	mm in.				kg lbs.
79.771 3.1406	60.325 2.3750	-9.4 -0.37	6.8 0.27	285.0 11.22	292.0 11.50	3.5 0.14	398.3 15.68	397.0 15.63	10.4 0.41	6.1 0.24	1551.8	152.3	0.1498	44.40 97.88
120.650 4.7500	92.075 3.6250	-31.0 -1.22	6.4 0.25	290.0 11.42	299.0 11.77	6.4 0.25	450.5 17.74	444.0 17.48	18.6 0.73	4.0 0.16	2247.3	171.9	0.1664	95.98 211.61
28.575 1.1250	25.400 1.0000	20.3 0.80	1.5 0.06	275.0 10.83	275.0 10.83	1.5 0.06	315.0 12.40	312.0 12.28	1.3 0.05	1.3 0.05	1028.2	496.4	0.1676	5.19 11.43
57.150 2.2500	44.450 1.7500	5.1 0.20	3.5 0.14	279.0 10.98	283.0 11.14	3.3 0.13	342.9 13.50	335.0 13.19	5.8 0.23	3.4 0.14	1554.1	212.2	0.1536	15.48 34.14
62.000 2.4409	44.450 1.7500	5.1 0.20	3.5 0.14	280.0 11.02	284.0 11.18	3.3 0.13	342.9 13.50	335.0 13.19	4.2 0.16	1.7 0.07	1411.7	193.7	0.1484	15.54 34.27
33.470 1.3177	25.400 1.0000	19.3 0.76	1.5 0.06	276.0 10.87	277.0 10.91	1.5 0.06	315.0 12.40	312.0 12.28	1.0 0.04	-0.9 -0.03	916.6	595.1	0.1613	5.41 11.92
33.470 1.3177	25.400 1.0000	19.6 0.77	1.5 0.06	275.0 10.83	277.0 10.91	1.5 0.06	315.0 12.40	312.0 12.28	0.5 0.02	-0.8 -0.03	993.2	480.2	0.1656	5.37 11.82
22.225 0.8750	15.875 0.6250	21.1 0.83	1.5 0.06	275.0 10.83	277.0 10.91	1.5 0.06	312.0 12.28	310.0 12.20	1.7 0.06	1.9 0.08	906.8	658.2	0.1567	3.36 7.40
28.575 1.1250	25.400 1.0000	20.3 0.80	1.5 0.06	277.0 10.91	277.0 10.91	1.5 0.06	315.0 12.40	312.0 12.28	1.3 0.05	1.3 0.05	1028.2	496.4	0.1676	4.91 10.80
34.039 1.3401	25.400 1.0000	19.3 0.76	1.5 0.06	276.0 10.87	278.0 10.94	1.5 0.06	315.0 12.40	312.0 12.28	1.0 0.04	-1.5 -0.06	916.6	595.1	0.1613	5.43 11.98
33.470 1.3177	25.400 1.0000	19.6 0.77	1.5 0.06	275.0 10.83	277.0 10.91	1.5 0.06	315.0 12.40	312.0 12.28	0.5 0.02	-0.8 -0.03	993.2	480.2	0.1656	5.35 11.79
57.150 2.2500	44.450 1.7500	5.1 0.20	3.5 0.14	281.0 11.06	285.0 11.22	3.3 0.13	342.9 13.50	335.0 13.19	5.8 0.23	3.4 0.14	1554.1	212.2	0.1536	14.92 32.91
57.150 2.2500	44.450 1.7500	5.1 0.20	10.5 0.41	281.0 11.06	299.0 11.77	3.3 0.13	342.9 13.50	335.0 13.19	5.8 0.23	3.4 0.14	1554.1	212.2	0.1536	14.79 32.61
57.150 2.2500	44.450 1.7500	5.1 0.20	9.7 0.38	281.0 11.06	297.0 11.69	3.3 0.13	342.9 13.50	335.0 13.19	5.8 0.23	3.4 0.14	1554.1	212.2	0.1536	14.81 32.66
69.850 2.7500	50.005 1.9687	2.5 0.10	6.4 0.25	287.0 11.30	296.0 11.65	6.4 0.25	378.1 14.89	366.0 14.41	14.4 0.56	3.3 0.13	1451.8	201.3	0.1555	26.36 58.13
69.850 2.7500	46.038 1.8125	2.5 0.10	6.4 0.25	287.0 11.30	296.0 11.65	6.4 0.25	378.1 14.89	371.0 14.61	14.4 0.56	3.3 0.13	1451.8	201.3	0.1555	27.75 61.18
69.850 2.7500	46.038 1.8125	2.5 0.10	6.4 0.25	287.0 11.30	296.0 11.65	6.4 0.25	378.5 14.90	373.0 14.69	14.4 0.56	3.3 0.13	1451.8	201.3	0.1555	28.60 63.07

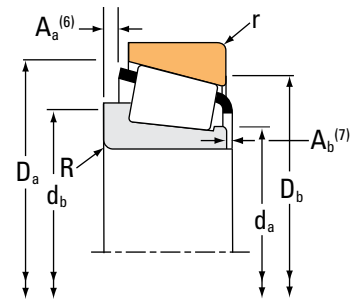
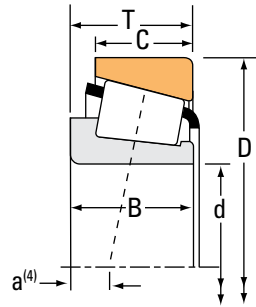
<sup>(4)</sup>Negative value indicates effective center inside cone (inner-ring) backface.  
<sup>(5)</sup>These maximum fillet radii will be cleared by the bearing corners.  
<sup>(6)</sup>Negative value indicates cage extends beyond cone (inner-ring) backface.  
<sup>(7)</sup>Negative value indicates cage that does not extend beyond cone (inner-ring) front face.

Continued on next page.

# TAPERED ROLLER BEARINGS

## SINGLE-ROW • TYPE TS

### TYPE TS



Bearing Dimensions			Load Ratings							Part Number		
Bore d	O.D. D	Width T	Dynamic <sup>(1)</sup>		Factors <sup>(2)</sup>		Dynamic <sup>(3)</sup>		Factors <sup>(2)</sup>	Static	Inner	Outer
			C <sub>1</sub>	e	Y	C <sub>90</sub>	C <sub>a90</sub>	K	C <sub>0</sub>			
mm in.	mm in.	mm in.	N lbf			N lbf	N lbf			N lbf		
266.700 10.5000	444.500 17.5000	120.650 4.7500	1820000 410000	0.58	1.04	473000 106000	466000 105000	1.01		3520000 791000	H852849	H852810
269.875 10.6250	381.000 15.0000	74.612 2.9375	1150000 258000	0.33	1.80	298000 67000	170000 38100	1.76		2030000 455000	M252349	M252310
269.875 10.6250	381.000 15.0000	74.612 2.9375	1260000 283000	0.33	1.80	326000 73200	185000 41700	1.76		2030000 455000	M252349H	M252310X
273.050 10.7500	393.700 15.5000	73.817 2.9062	1010000 228000	0.40	1.49	262000 59000	181000 40600	1.45		1600000 359000	EE275108	275155
273.050 10.7500	403.225 15.8750	69.850 2.7500	1010000 228000	0.40	1.49	262000 59000	181000 40600	1.45		1600000 359000	EE275108	275158
273.050 10.7500	406.400 16.0000	69.850 2.7500	1010000 228000	0.40	1.49	262000 59000	181000 40600	1.45		1600000 359000	EE275108	275160
275.000 10.8268	352.425 13.8750	36.513 1.4375	306000 68700	0.54	1.11	79200 17800	73100 16400	1.08		664000 149000	L853048	L853010W
276.225 10.8750	352.425 13.8750	36.512 1.4375	333000 74900	0.54	1.11	86300 19400	79600 17900	1.08		750000 169000	L853049	L853010
279.400 11.0000	317.500 12.5000	24.384 0.9600	162000 36500	0.35	1.73	42100 9460	24900 5610	1.69		467000 105000	LL352149	LL352110
279.400 11.0000	317.500 12.5000	24.384 0.9600	162000 36500	0.35	1.73	42100 9460	24900 5610	1.69		467000 105000	KLL352149	KLL352110
279.400 11.0000	374.650 14.7500	47.625 1.8750	520000 117000	0.40	1.49	135000 30300	92700 20800	1.45		1150000 258000	L555233	L555210
279.400 11.0000	469.900 18.5000	95.250 3.7500	1610000 363000	0.38	1.59	418000 94000	271000 60800	1.55		2350000 527000	EE722110	722185
279.400 11.0000	488.950 19.2500	120.650 4.7500	2420000 544000	0.31	1.92	628000 141000	336000 75600	1.87		3310000 744000	EE295110	295193
279.982 11.0229	380.009 14.9610	65.088 2.5625	722000 162000	0.43	1.39	187000 42100	138000 31100	1.35		1720000 387000	LM654642	LM654611
280.000 11.0236	406.400 16.0000	69.850 2.7500	868000 195000	0.39	1.55	225000 50600	149000 33400	1.51		1660000 374000	EE128112	128160
280.192 11.0312	400.050 15.7500	52.388 2.0625	690000 155000	0.41	1.47	179000 40200	125000 28100	1.43		1180000 266000	EE101103	101575
280.192 11.0312	406.400 16.0000	52.388 2.0625	690000 155000	0.41	1.47	179000 40200	125000 28100	1.43		1180000 266000	EE101103	101600

<sup>(1)</sup>Based on  $1 \times 10^6$  revolutions  $L_{10}$  life, for the ISO life-calculation method.

<sup>(2)</sup>Consult your Timken engineer for instructions on use or review the Timken Engineering Manual on [timken.com/catalogs](http://timken.com/catalogs).

<sup>(3)</sup>Based on  $90 \times 10^6$  revolutions  $L_{10}$  life, for The Timken Company life-calculation method.  $C_{90}$  and  $C_{a90}$  are radial and thrust values.



Bearing Dimensions											Geometry Factors			Bearing Weight
Width B	Width C	Eff. Ctr. a <sup>(4)</sup>	Shaft			Housing			Cage		G <sub>1</sub>	G <sub>2</sub>	C <sub>g</sub>	
			Max Shaft Fillet Radius R <sup>(5)</sup>	Backing Shoulder Dia. d <sub>a</sub>	Shoulder Dia. d <sub>b</sub>	Max Housing Fillet Radius r <sup>(5)</sup>	Backing Shoulder Dia. D <sub>a</sub>	Shoulder Dia. D <sub>b</sub>	A <sub>a</sub> <sup>(6)</sup>	A <sub>b</sub> <sup>(7)</sup>				
mm in.	mm in.	mm in.	mm in.	mm in.	mm in.	mm in.	mm in.	mm in.	mm in.	mm in.				kg lbs.
117.475 4.6250	88.900 3.5000	-0.5 -0.02	6.4 0.25	296.9 11.69	315.0 12.40	6.4 0.25	422.3 16.63	390.0 15.35	19.2 0.75	4.2 0.17	2254.5	171.3	0.2040	72.39 159.61
74.612 2.9375	57.150 2.2500	-6.6 -0.26	6.4 0.25	287.0 11.30	296.0 11.65	3.3 0.13	364.0 14.32	356.0 14.02	8.3 0.32	3.6 0.14	1839.2	226.1	0.1588	25.22 55.57
74.612 2.9375	57.150 2.2500	-6.6 -0.26	6.4 0.25	288.0 11.34	297.0 11.69	3.3 0.13	364.0 14.32	356.0 14.02	8.3 0.32	3.5 0.14	1839.2	226.1	0.1588	25.48 56.18
69.850 2.7500	50.005 1.9687	2.5 0.10	6.4 0.25	291.0 11.46	301.0 11.85	6.4 0.25	378.1 14.89	366.0 14.41	14.4 0.56	3.3 0.13	1451.8	201.3	0.1555	24.98 55.07
69.850 2.7500	46.038 1.8125	2.5 0.10	6.4 0.25	291.0 11.46	301.0 11.85	6.4 0.25	378.1 14.89	371.0 14.61	14.4 0.56	3.3 0.13	1451.8	201.3	0.1555	26.37 58.12
69.850 2.7500	46.038 1.8125	2.5 0.10	6.4 0.25	291.0 11.46	301.0 11.85	6.4 0.25	378.5 14.90	373.0 14.69	14.4 0.56	3.3 0.13	1451.8	201.3	0.1555	27.22 60.01
40.000 1.5748	23.812 0.9375	35.1 1.38	3.5 0.14	287.0 11.30	292.0 11.50	3.3 0.13	342.0 13.46	332.0 13.07	4.2 0.16	0.3 0.01	970.3	322.9	0.1471	8.32 18.34
34.925 1.3750	23.812 0.9375	35.1 1.38	3.5 0.14	288.0 11.34	293.0 11.54	3.3 0.13	342.0 13.46	332.0 13.07	5.9 0.23	3.5 0.14	1057.3	350.4	0.1517	7.72 17.03
24.384 0.9600	18.288 0.7200	20.3 0.80	1.5 0.06	286.0 11.26	288.0 11.34	1.5 0.06	312.0 12.28	309.0 12.17	1.8 0.07	2.1 0.09	1131.2	795.2	0.1688	2.57 5.66
24.384 0.9600	18.288 0.7200	20.3 0.80	1.5 0.06	286.0 11.26	288.0 11.34	1.5 0.06	312.0 12.28	309.0 12.17	1.8 0.07	2.1 0.09	1131.2	795.2	0.1688	2.57 5.66
47.625 1.8750	34.925 1.3750	17.5 0.69	3.5 0.14	296.0 11.65	300.0 11.81	3.3 0.13	362.0 14.25	355.0 13.98	5.5 0.21	2.4 0.10	1476.9	368.2	0.1553	13.90 30.65
93.662 3.6875	69.850 2.7500	-7.6 -0.30	9.7 0.38	314.0 12.36	321.0 12.64	3.3 0.13	432.9 17.04	430.0 16.93	16.8 0.66	0.5 0.02	1894.4	142.6	0.1669	59.62 131.44
120.650 4.7500	92.075 3.6250	-31.0 -1.22	1.3 0.05	304.0 11.97	303.0 11.93	6.4 0.25	450.5 17.74	444.0 17.48	19.4 0.76	3.5 0.14	2247.3	171.9	0.1664	88.48 195.09
65.088 2.5625	49.212 1.9375	11.4 0.45	3.5 0.14	298.0 11.73	302.0 11.89	3.3 0.13	368.0 14.49	356.0 14.02	7.9 0.31	0.8 0.03	1916.4	265.6	0.1744	20.75 45.73
67.673 2.6643	53.975 2.1250	6.6 0.26	6.4 0.25	307.0 12.09	308.0 12.13	3.3 0.13	384.0 15.12	378.0 14.88	8.2 0.32	0.9 0.04	1622.7	240.4	0.1592	27.08 59.71
50.211 1.9768	34.925 1.3750	15.7 0.62	6.8 0.27	307.0 12.09	309.0 12.17	3.3 0.13	376.0 14.80	374.0 14.72	7.7 0.30	5.3 0.21	1380.2	226.7	0.1527	18.44 40.64
50.211 1.9768	34.925 1.3750	15.7 0.62	6.8 0.27	307.0 12.09	309.0 12.17	3.3 0.13	376.0 14.80	377.0 14.84	7.7 0.30	5.3 0.21	1380.2	226.7	0.1527	19.53 43.06

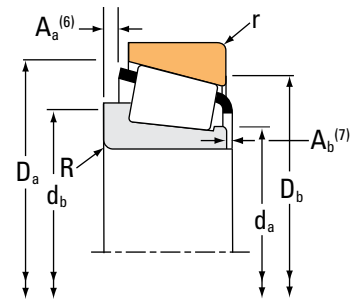
<sup>(4)</sup>Negative value indicates effective center inside cone (inner-ring) backface.  
<sup>(5)</sup>These maximum fillet radii will be cleared by the bearing corners.  
<sup>(6)</sup>Negative value indicates cage extends beyond cone (inner-ring) backface.  
<sup>(7)</sup>Negative value indicates cage that does not extend beyond cone (inner-ring) front face.

Continued on next page.

# TAPERED ROLLER BEARINGS

## SINGLE-ROW • TYPE TS

### TYPE TS



Bearing Dimensions			Load Ratings							Part Number		
Bore d	O.D. D	Width T	Dynamic <sup>(1)</sup>		Factors <sup>(2)</sup>		Dynamic <sup>(3)</sup>		Factors <sup>(2)</sup>	Static	Inner	Outer
			C <sub>1</sub>	e	Y	C <sub>90</sub>	C <sub>a90</sub>	K	C <sub>0</sub>			
mm in.	mm in.	mm in.	N lbf			N lbf	N lbf			N lbf		
280.192 11.0312	406.400 16.0000	69.850 2.7500	868000 195000	0.39	1.55	225000 50600	149000 33400	1.51	1660000 374000	EE128111	128160	
280.192 11.0312	406.400 16.0000	69.850 2.7500	924000 208000	0.39	1.55	240000 53900	158000 35600	1.51	1820000 409000	EE128110	128160	
280.192 11.0312	409.981 16.1410	69.850 2.7500	868000 195000	0.39	1.55	225000 50600	149000 33400	1.51	1660000 374000	EE128111	128161	
280.192 11.0312	409.981 16.1410	69.850 2.7500	924000 208000	0.39	1.55	240000 53900	158000 35600	1.51	1820000 409000	EE128110	128161	
285.750 11.2500	354.012 13.9375	33.338 1.3125	258000 58000	0.49	1.22	66800 15000	56300 12600	1.19	596000 134000	545112	545139	
285.750 11.2500	358.775 14.1250	33.338 1.3125	258000 58000	0.49	1.22	66800 15000	56300 12600	1.19	596000 134000	545112	545141	
285.750 11.2500	380.898 14.9960	65.088 2.5625	722000 162000	0.43	1.39	187000 42100	138000 31100	1.35	1720000 387000	LM654649	LM654610	
285.750 11.2500	469.900 18.5000	81.770 3.2193	1510000 339000	0.29	2.05	391000 88000	196000 44000	2.00	1990000 447000	EE921124	921850	
285.750 11.2500	476.250 18.7500	81.770 3.2193	1510000 339000	0.29	2.05	391000 88000	196000 44000	2.00	1990000 447000	EE921124	921875	
288.925 11.3750	406.400 16.0000	77.788 3.0625	1190000 267000	0.34	1.77	308000 69300	179000 40100	1.73	2520000 567000	M255449	M255410	
288.925 11.3750	406.400 16.0000	77.788 3.0625	1360000 307000	0.34	1.77	354000 79500	205000 46000	1.73	2520000 567000	M255449H	M255410	
289.975 11.4163	393.700 15.5000	50.800 2.0000	586000 132000	0.36	1.67	152000 34200	93500 21000	1.63	1310000 295000	L357040	L357010	
292.100 11.5000	374.650 14.7500	47.625 1.8750	520000 117000	0.40	1.49	135000 30300	92700 20800	1.45	1150000 258000	L555249	L555210	
292.100 11.5000	393.700 15.5000	63.500 2.5000	548000 123000	0.61	0.98	142000 31900	148000 33300	0.96	997000 224000	84115	84155	
292.100 11.5000	469.900 18.5000	95.250 3.7500	1610000 363000	0.38	1.59	418000 94000	271000 60800	1.55	2350000 527000	EE722115	722185	
292.100 11.5000	520.700 20.5000	107.950 4.2500	1950000 439000	0.33	1.83	506000 114000	284000 63900	1.78	3330000 749000	EE224115	224204	
292.100 11.5000	558.800 22.0000	136.525 5.3750	3090000 695000	0.40	1.52	802000 180000	542000 122000	1.48	4100000 923000	EE790114	790221	

<sup>(1)</sup>Based on 1 x 10<sup>6</sup> revolutions L<sub>10</sub> life, for the ISO life-calculation method.

<sup>(2)</sup>Consult your Timken engineer for instructions on use or review the Timken Engineering Manual on timken.com/catalogs.

<sup>(3)</sup>Based on 90 x 10<sup>6</sup> revolutions L<sub>10</sub> life, for The Timken Company life-calculation method. C<sub>90</sub> and C<sub>a90</sub> are radial and thrust values.

Bearing Dimensions											Geometry Factors			Bearing Weight
Width B	Width C	Eff. Ctr. a <sup>(4)</sup>	Shaft			Housing			Cage		G <sub>1</sub>	G <sub>2</sub>	C <sub>g</sub>	
			Max Shaft Fillet Radius R <sup>(5)</sup>	Backing Shoulder Dia. d <sub>a</sub>	Shoulder Dia. d <sub>b</sub>	Max Housing Fillet Radius r <sup>(5)</sup>	Backing Shoulder Dia. D <sub>a</sub>	Shoulder Dia. D <sub>b</sub>	A <sub>a</sub> <sup>(6)</sup>	A <sub>b</sub> <sup>(7)</sup>				
mm in.	mm in.	mm in.	mm in.	mm in.	mm in.	mm in.	mm in.	mm in.	mm in.	mm in.				kg lbs.
67.673 2.6643	53.975 2.1250	6.6 0.26	6.8 0.27	307.0 12.09	309.0 12.17	3.3 0.13	384.0 15.12	378.0 14.88	8.2 0.32	0.9 0.04	1622.7	240.4	0.1592	27.01 59.56
67.673 2.6643	53.975 2.1250	6.6 0.26	6.8 0.27	307.0 12.09	309.0 12.17	3.3 0.13	384.0 15.12	378.0 14.88	6.8 0.27	1.5 0.06	1727.7	255.2	0.1628	27.97 61.67
67.673 2.6643	53.975 2.1250	6.6 0.26	6.8 0.27	307.0 12.09	309.0 12.17	3.3 0.13	384.0 15.12	379.0 14.92	8.2 0.32	0.9 0.04	1622.7	240.4	0.1592	27.98 61.70
67.673 2.6643	53.975 2.1250	6.6 0.26	6.8 0.27	307.0 12.09	309.0 12.17	3.3 0.13	384.0 15.12	379.0 14.92	6.8 0.27	1.5 0.06	1727.7	255.2	0.1628	28.94 63.81
31.750 1.2500	22.225 0.8750	32.8 1.29	3.5 0.14	298.0 11.73	302.0 11.89	3.3 0.13	345.0 13.58	338.0 13.31	5.6 0.22	2.9 0.12	1015.9	545.5	0.1446	6.28 13.84
31.750 1.2500	22.225 0.8750	32.8 1.29	3.5 0.14	298.0 11.73	302.0 11.89	3.3 0.13	345.0 13.58	340.0 13.39	5.6 0.22	2.9 0.12	1015.9	545.5	0.1446	6.74 14.86
65.088 2.5625	49.212 1.9375	11.4 0.45	3.5 0.14	302.0 11.89	306.0 12.05	3.3 0.13	368.0 14.49	356.0 14.02	7.9 0.31	0.8 0.03	1916.4	265.6	0.1744	19.62 43.23
80.569 3.1720	57.150 2.2500	-13.5 -0.53	9.7 0.38	309.0 12.17	325.0 12.80	3.3 0.13	440.0 17.32	439.0 17.28	16.2 0.63	6.0 0.24	1732.1	200.0	0.1481	48.70 107.38
80.569 3.1720	57.150 2.2500	-13.5 -0.53	9.7 0.38	309.0 12.17	325.0 12.80	3.3 0.13	442.0 17.40	442.0 17.40	16.2 0.63	6.0 0.24	1732.1	200.0	0.1481	50.81 112.03
77.788 3.0625	60.325 2.3750	-4.1 -0.16	6.4 0.25	310.0 12.20	316.0 12.44	3.3 0.13	387.9 15.27	379.0 14.92	5.8 0.22	4.0 0.16	2301.3	287.6	0.1722	30.80 67.90
77.788 3.0625	60.325 2.3750	-4.1 -0.16	6.4 0.25	311.0 12.24	317.0 12.48	3.3 0.13	387.9 15.27	379.0 14.92	5.8 0.22	4.0 0.16	2301.3	287.6	0.1722	30.90 68.15
50.800 2.0000	38.100 1.5000	12.7 0.50	6.4 0.25	308.0 12.13	318.0 12.52	3.3 0.13	380.0 14.96	374.0 14.72	5.6 0.22	2.0 0.08	1753.3	301.0	0.1585	17.19 37.89
47.625 1.8750	34.925 1.3750	17.5 0.69	3.5 0.14	305.0 12.01	309.0 12.17	3.3 0.13	362.0 14.25	355.0 13.98	5.5 0.21	2.4 0.10	1476.9	368.2	0.1553	11.78 25.97
50.800 2.0000	44.450 1.7500	36.6 1.44	3.5 0.14	309.0 12.17	313.0 12.32	6.4 0.25	378.0 14.88	363.0 14.29	13.8 0.54	2.8 0.11	1227.4	302.3	0.1660	17.86 39.37
93.662 3.6875	69.850 2.7500	-7.6 -0.30	9.7 0.38	324.0 12.76	330.0 12.99	3.3 0.13	432.9 17.04	430.0 16.93	16.8 0.66	0.5 0.02	1894.4	142.6	0.1669	55.13 121.54
107.950 4.2500	76.200 3.0000	-19.8 -0.78	6.4 0.25	321.0 12.64	331.0 13.03	6.4 0.25	470.0 18.50	468.0 18.43	15.3 0.60	3.3 0.13	2630.1	228.6	0.1780	92.50 203.91
136.525 5.3750	98.425 3.8750	-24.4 -0.96	6.4 0.25	329.0 12.95	335.0 13.19	6.4 0.25	514.2 20.24	501.0 19.72	20.0 0.78	7.3 0.29	2663.9	170.3	0.1898	139.90 308.45

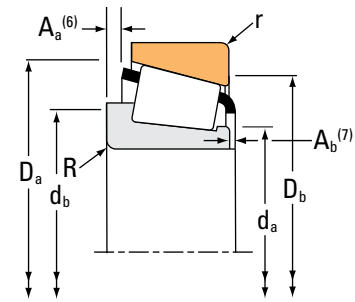
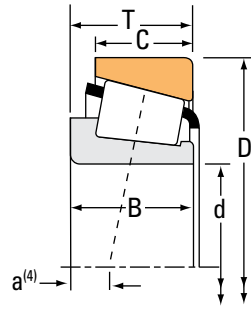
<sup>(4)</sup>Negative value indicates effective center inside cone (inner-ring) backface.  
<sup>(5)</sup>These maximum fillet radii will be cleared by the bearing corners.  
<sup>(6)</sup>Negative value indicates cage extends beyond cone (inner-ring) backface.  
<sup>(7)</sup>Negative value indicates cage that does not extend beyond cone (inner-ring) front face.

Continued on next page.

# TAPERED ROLLER BEARINGS

## SINGLE-ROW • TYPE TS

### TYPE TS



Bearing Dimensions			Load Ratings							Part Number		
Bore d	O.D. D	Width T	Dynamic <sup>(1)</sup>		Factors <sup>(2)</sup>		Dynamic <sup>(3)</sup>		Factors <sup>(2)</sup>	Static	Inner	Outer
			C <sub>1</sub>	e	Y	C <sub>90</sub>	C <sub>a90</sub>	K	C <sub>0</sub>			
mm in.	mm in.	mm in.	N lbf			N lbf	N lbf			N lbf		
292.100 11.5000	558.800 22.0000	136.525 5.3750	3090000 695000	0.40	1.52	802000 180000	542000 122000	1.48		4100000 923000	EE790116	790221
298.450 11.7500	431.800 17.0000	69.850 2.7500	613000 138000	0.44	1.37	159000 35700	119000 26800	1.33		1280000 288000	EE111175	111700
298.450 11.7500	444.500 17.5000	63.500 2.5000	887000 199000	0.38	1.59	230000 51700	149000 33400	1.55		1390000 312000	EE291175	291750
299.975 11.8100	495.300 19.5000	141.288 5.5625	2870000 645000	0.33	1.80	744000 167000	423000 95200	1.76		5650000 1270000	HH258248	HH258210
300.038 11.8125	422.275 16.6250	82.550 3.2500	1300000 292000	0.34	1.78	336000 75600	194000 43600	1.73		2770000 622000	HM256849	HM256810
304.800 12.0000	393.700 15.5000	50.800 2.0000	586000 132000	0.36	1.67	152000 34200	93500 21000	1.63		1310000 295000	L357049	L357010
304.800 12.0000	406.400 16.0000	63.500 2.5000	769000 173000	0.44	1.36	199000 44800	151000 33900	1.32		1740000 392000	LM757049	LM757010
304.800 12.0000	406.400 16.0000	63.500 2.5000	815000 183000	0.44	1.36	211000 47500	160000 35900	1.32		1740000 392000	LM757049AA	LM757010
304.800 12.0000	438.048 17.2460	76.200 3.0000	896000 201000	0.42	1.44	232000 52200	165000 37200	1.40		1780000 401000	EE129120X	129172
304.800 12.0000	444.500 17.5000	63.500 2.5000	887000 199000	0.38	1.59	230000 51700	149000 33400	1.55		1390000 312000	EE291201	291750
304.800 12.0000	444.500 17.5000	63.500 2.5000	887000 199000	0.38	1.59	230000 51700	149000 33400	1.55		1390000 312000	EE291201	291749
304.800 12.0000	495.300 19.5000	76.200 3.0000	1550000 348000	0.40	1.49	402000 90300	277000 62200	1.45		2090000 471000	EE941205	941950
304.800 12.0000	495.300 19.5000	76.200 3.0000	1550000 348000	0.40	1.49	402000 90300	277000 62200	1.45		2090000 471000	EE941205X	941950
304.800 12.0000	495.300 19.5000	95.250 3.7500	1690000 379000	0.40	1.49	437000 98300	301000 67700	1.45		2550000 573000	EE724120	724195
304.800 12.0000	495.300 19.5000	95.250 3.7500	1510000 339000	0.40	1.49	392000 88000	269000 60600	1.45		2650000 595000	EE724119	724195
304.800 12.0000	499.948 19.6830	101.600 4.0000	1340000 300000	1.17	0.51	346000 77900	695000 156000	0.50		1890000 424000	M959442	M959410
304.800 12.0000	558.800 22.0000	136.525 5.3750	3090000 695000	0.40	1.52	802000 180000	542000 122000	1.48		4100000 923000	EE790120	790221

<sup>(1)</sup>Based on 1 x 10<sup>6</sup> revolutions L<sub>10</sub> life, for the ISO life-calculation method.

<sup>(2)</sup>Consult your Timken engineer for instructions on use or review the Timken Engineering Manual on timken.com/catalogs.

<sup>(3)</sup>Based on 90 x 10<sup>6</sup> revolutions L<sub>10</sub> life, for The Timken Company life-calculation method. C<sub>90</sub> and C<sub>a90</sub> are radial and thrust values.

Bearing Dimensions											Geometry Factors			Bearing Weight
Width B	Width C	Eff. Ctr. a <sup>(4)</sup>	Shaft			Housing			Cage		G <sub>1</sub>	G <sub>2</sub>	C <sub>g</sub>	
			Max Shaft Fillet Radius R <sup>(5)</sup>	Backing Shoulder Dia. d <sub>a</sub>	Shoulder Dia. d <sub>b</sub>	Max Housing Fillet Radius r <sup>(5)</sup>	Backing Shoulder Dia. D <sub>a</sub>	Shoulder Dia. D <sub>b</sub>	A <sub>a</sub> <sup>(6)</sup>	A <sub>b</sub> <sup>(7)</sup>				
mm in.	mm in.	mm in.	mm in.	mm in.	mm in.	mm in.	mm in.	mm in.	mm in.	mm in.				kg lbs.
136.525 5.3750	98.425 3.8750	-24.4 -0.96	19.8 0.78	329.0 12.95	362.0 14.25	6.4 0.25	514.2 20.24	501.0 19.72	20.0 0.78	7.3 0.29	2663.9	170.3	0.1898	138.58 305.52
58.738 2.3125	53.975 2.1250	16.3 0.64	6.4 0.25	319.0 12.56	328.0 12.91	3.3 0.13	406.2 15.99	401.0 15.79	15.3 0.60	2.2 0.09	1603.5	266.6	0.1640	28.48 62.78
61.912 2.4375	39.688 1.5625	7.6 0.30	8.0 0.31	320.0 12.60	332.0 13.07	1.5 0.06	415.0 16.34	416.0 16.38	11.4 0.45	7.1 0.28	1579.2	244.8	0.1557	29.47 64.98
141.288 5.5625	114.300 4.5000	-34.5 -1.36	6.4 0.25	332.0 13.07	342.0 13.46	6.4 0.25	467.0 18.40	448.0 17.64	10.6 0.42	7.7 0.31	3853.2	220.0	0.2048	110.43 243.46
82.550 3.2500	63.500 2.5000	-5.6 -0.22	6.4 0.25	319.0 12.56	328.0 12.91	3.3 0.13	403.0 15.88	394.0 15.51	7.4 0.29	3.6 0.14	2548.4	281.8	0.1779	35.46 78.17
50.800 2.0000	38.100 1.5000	12.7 0.50	6.4 0.25	319.0 12.56	329.0 12.95	3.3 0.13	380.0 14.96	374.0 14.72	5.6 0.22	2.0 0.08	1753.3	301.0	0.1585	14.43 31.80
63.500 2.5000	47.625 1.8750	16.3 0.64	6.4 0.25	322.0 12.68	331.0 13.03	3.3 0.13	393.0 15.47	380.0 14.96	6.9 0.27	2.5 0.10	1988.6	260.3	0.1775	21.61 47.63
63.500 2.5000	47.625 1.8750	16.3 0.64	12.7 0.50	322.0 12.68	344.0 13.54	3.3 0.13	393.0 15.47	380.0 14.96	6.9 0.27	2.5 0.10	1988.6	260.3	0.1775	21.44 47.25
76.992 3.0312	53.975 2.1250	7.4 0.29	6.4 0.25	328.0 12.91	334.0 13.15	4.8 0.19	411.4 16.20	406.0 15.98	14.9 0.59	-2.0 -0.07	1882.6	272.9	0.1711	33.07 72.90
61.912 2.4375	39.688 1.5625	7.6 0.30	8.0 0.31	324.0 12.76	337.0 13.27	1.5 0.06	415.0 16.34	416.0 16.38	11.4 0.45	7.1 0.28	1579.2	244.8	0.1557	28.01 61.76
61.912 2.4375	39.688 1.5625	7.6 0.30	8.0 0.31	324.0 12.76	337.0 13.27	3.3 0.13	415.0 16.34	415.0 16.34	11.4 0.45	7.1 0.28	1579.2	244.8	0.1557	27.96 61.65
74.612 2.9375	53.975 2.1250	9.1 0.36	6.4 0.25	329.0 12.95	339.0 13.35	3.3 0.13	462.7 18.22	459.0 18.07	10.2 0.40	6.0 0.24	1771.6	187.4	0.1657	51.58 113.70
77.866 3.0656	53.975 2.1250	9.1 0.36	6.4 0.25	332.0 13.07	339.0 13.35	3.3 0.13	462.7 18.22	459.0 18.07	10.2 0.40	2.7 0.11	1771.6	187.4	0.1657	52.27 115.23
92.075 3.6250	69.850 2.7500	-1.5 -0.06	16.0 0.63	330.0 12.99	359.0 14.13	6.4 0.25	458.9 18.07	450.0 17.72	17.3 0.68	2.3 0.09	2183.9	165.7	0.1783	62.67 138.16
92.075 3.6250	69.850 2.7500	-1.5 -0.06	16.0 0.63	330.0 12.99	359.0 14.13	6.4 0.25	458.9 18.07	450.0 17.72	14.3 0.56	4.9 0.20	2242.3	170.0	0.1800	65.74 144.92
79.375 3.1250	53.975 2.1250	105.4 4.15	6.4 0.25	344.0 13.54	353.0 13.90	6.4 0.25	481.1 18.94	438.0 17.24	* *	* *	1521.2	157.5	0.2137	65.25 143.84
136.525 5.3750	98.425 3.8750	-24.4 -0.96	1.3 0.05	335.0 13.19	335.0 13.19	6.4 0.25	514.2 20.24	501.0 19.72	20.0 0.78	7.3 0.29	2663.9	170.3	0.1898	133.72 294.82

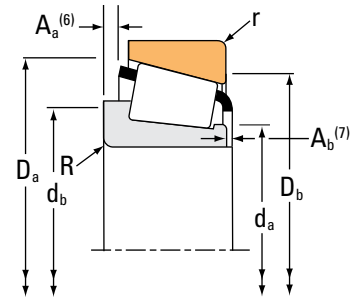
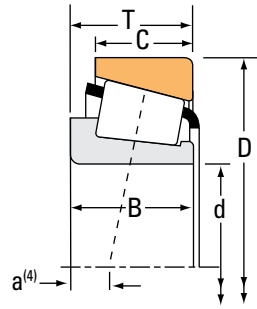
(4) Negative value indicates effective center inside cone (inner-ring) backface.  
 (5) These maximum fillet radii will be cleared by the bearing corners.  
 (6) Negative value indicates cage extends beyond cone (inner-ring) backface.  
 (7) Negative value indicates cage that does not extend beyond cone (inner-ring) front face.  
 (\*) Contact your Timken engineer for details.

Continued on next page.

# TAPERED ROLLER BEARINGS

## SINGLE-ROW • TYPE TS

### TYPE TS



Bearing Dimensions			Load Ratings							Part Number		
Bore d	O.D. D	Width T	Dynamic <sup>(1)</sup>		Factors <sup>(2)</sup>		Dynamic <sup>(3)</sup>		Factors <sup>(2)</sup>	Static	Inner	Outer
			C <sub>1</sub>	e	Y	C <sub>90</sub>	C <sub>a90</sub>	K	C <sub>0</sub>			
mm in.	mm in.	mm in.	N lbf			N lbf	N lbf			N lbf		
304.800 12.0000	647.700 25.5000	139.700 5.5000	2350000 528000	0.87	0.69	609000 137000	903000 203000	0.67		3520000 790000	EE991201	992550
305.054 12.0100	406.400 16.0000	63.500 2.5000	769000 173000	0.44	1.36	199000 44800	151000 33900	1.32		1740000 392000	LM757049A	LM757010
309.880 12.2000	501.650 19.7500	98.425 3.8750	2600000 585000	0.30	2.00	675000 152000	346000 77900	1.95		3770000 848000	HM161040	HM161012
312.738 12.3125	358.775 14.1250	22.225 0.8750	134000 30000	0.82	0.73	34700 7790	48900 11000	0.71		383000 86100	LL957049	LL957010
314.325 12.3750	495.300 19.5000	120.650 4.7500	1960000 440000	0.58	1.04	508000 114000	500000 113000	1.01		3950000 889000	H859049	H859010
317.500 12.5000	444.500 17.5000	63.500 2.5000	887000 199000	0.38	1.59	230000 51700	149000 33400	1.55		1390000 312000	EE291250	291750
317.500 12.5000	444.500 17.5000	63.500 2.5000	887000 199000	0.38	1.59	230000 51700	149000 33400	1.55		1390000 312000	EE291250	291749
317.500 12.5000	447.675 17.6250	85.725 3.3750	1680000 377000	0.33	1.79	435000 97800	249000 56000	1.74		3140000 706000	HM259049	HM259010
317.500 12.5000	447.675 17.6250	85.725 3.3750	1690000 380000	0.33	1.79	438000 98500	251000 56500	1.74		2790000 628000	HM259048	HM259010
317.500 12.5000	457.200 18.0000	66.675 2.6250	996000 224000	0.39	1.53	258000 58000	173000 38900	1.49		1660000 373000	EE201250	201800
317.500 12.5000	596.900 23.5000	136.525 5.3750	3310000 744000	0.42	1.42	858000 193000	620000 139000	1.38		4600000 1030000	EE720125	720236
317.500 12.5000	622.300 24.5000	147.638 5.8125	3160000 710000	0.94	0.64	819000 184000	1310000 295000	0.62		4130000 927000	H961649	H961610
317.500 12.5000	647.700 25.5000	139.700 5.5000	2350000 528000	0.87	0.69	609000 137000	903000 203000	0.67		3520000 790000	EE991251	992550
320.675 12.6250	406.400 16.0000	50.800 2.0000	572000 129000	0.41	1.47	148000 33400	104000 23300	1.43		1260000 282000	L558548	L558510
323.850 12.7500	381.000 15.0000	28.575 1.1250	244000 54800	0.44	1.36	63100 14200	47600 10700	1.33		672000 151000	LL758744	LL758715
323.850 12.7500	422.275 16.6250	58.738 2.3125	748000 168000	0.39	1.55	194000 43600	129000 29000	1.51		1570000 352000	LM559048	LM559010
325.438 12.8125	596.900 23.5000	136.525 5.3750	3310000 744000	0.42	1.42	858000 193000	620000 139000	1.38		4600000 1030000	EE720128	720236

<sup>(1)</sup>Based on  $1 \times 10^6$  revolutions  $L_{10}$  life, for the ISO life-calculation method.

<sup>(2)</sup>Consult your Timken engineer for instructions on use or review the Timken Engineering Manual on [timken.com/catalogs](http://timken.com/catalogs).

<sup>(3)</sup>Based on  $90 \times 10^6$  revolutions  $L_{10}$  life, for The Timken Company life-calculation method.  $C_{90}$  and  $C_{a90}$  are radial and thrust values.

Bearing Dimensions											Geometry Factors			Bearing Weight
Width B	Width C	Eff. Ctr. a <sup>(4)</sup>	Shaft			Housing			Cage		G <sub>1</sub>	G <sub>2</sub>	C <sub>g</sub>	
			Max Shaft Fillet Radius R <sup>(5)</sup>	Backing Shoulder Dia. d <sub>a</sub>	Shoulder Dia. d <sub>b</sub>	Max Housing Fillet Radius r <sup>(5)</sup>	Backing Shoulder Dia. D <sub>a</sub>	Shoulder Dia. D <sub>b</sub>	A <sub>a</sub> <sup>(6)</sup>	A <sub>b</sub> <sup>(7)</sup>				
mm in.	mm in.	mm in.	mm in.	mm in.	mm in.	mm in.	mm in.	mm in.	mm in.	mm in.				kg lbs.
120.650 4.7500	88.900 3.5000	55.1 2.17	13.5 0.53	360.0 14.17	384.0 15.12	13.5 0.53	587.0 23.11	546.0 21.50	26.0 1.02	23.0 0.91	2353.6	161.7	0.2299	190.66 420.35
63.500 2.5000	47.625 1.8750	16.3 0.64	6.4 0.25	325.0 12.80	331.0 13.03	3.3 0.13	393.0 15.47	380.0 14.96	6.9 0.27	2.5 0.10	1988.6	260.3	0.1775	21.53 47.45
98.425 3.8750	79.375 3.1250	11.9 0.47	6.4 0.25	339.0 13.35	348.0 13.70	3.3 0.13	475.0 18.70	468.0 18.43	3.6 0.14	6.7 0.27	3153.6	239.4	0.1837	77.17 170.15
20.638 0.8125	14.288 0.5625	79.5 3.13	2.3 0.09	322.0 12.68	325.0 12.80	1.5 0.06	354.0 13.94	346.0 13.62	3.1 0.12	2.1 0.09	990.0	808.0	0.2091	3.06 6.75
119.062 4.6875	88.900 3.5000	8.4 0.33	6.4 0.25	344.8 13.57	361.0 14.21	6.4 0.25	473.0 18.62	439.0 17.28	17.7 0.70	3.7 0.15	2954.9	250.1	0.2225	83.09 183.19
61.912 2.4375	39.688 1.5625	7.6 0.30	8.0 0.31	334.0 13.15	346.0 13.62	1.5 0.06	415.0 16.34	416.0 16.38	11.4 0.45	7.1 0.28	1579.2	244.8	0.1557	24.99 55.11
61.912 2.4375	39.688 1.5625	7.6 0.30	8.0 0.31	334.0 13.15	346.0 13.62	3.3 0.13	415.0 16.34	415.0 16.34	11.4 0.45	7.1 0.28	1579.2	244.8	0.1557	24.94 55.01
85.725 3.3750	68.262 2.6875	-4.8 -0.19	3.5 0.14	337.0 13.27	341.0 13.43	3.3 0.13	427.7 16.84	418.0 16.46	6.8 0.27	3.8 0.15	2944.6	303.9	0.1863	41.94 92.46
85.725 3.3750	68.262 2.6875	-4.8 -0.19	3.5 0.14	337.0 13.27	341.0 13.43	3.3 0.13	427.7 16.84	418.0 16.46	6.4 0.25	3.8 0.15	2711.5	280.9	0.1809	40.57 89.44
65.088 2.5625	42.862 1.6875	9.7 0.38	6.8 0.27	337.0 13.27	348.0 13.70	6.8 0.27	429.2 16.90	424.0 16.69	15.1 0.59	4.1 0.17	1880.1	284.2	0.1672	30.68 67.63
136.525 5.3750	98.425 3.8750	-16.8 -0.66	19.8 0.78	353.0 13.90	390.0 15.35	6.4 0.25	547.4 21.55	534.0 21.02	20.4 0.80	7.9 0.32	3159.0	183.3	0.2053	160.44 353.72
131.762 5.1875	82.550 3.2500	60.5 2.38	14.3 0.56	373.0 14.69	410.0 16.14	12.7 0.50	581.6 22.90	531.0 20.91	25.1 0.98	17.7 0.70	2502.7	149.1	0.2401	178.13 392.68
120.650 4.7500	88.900 3.5000	55.1 2.17	13.5 0.53	371.0 14.61	394.0 15.51	13.5 0.53	587.0 23.11	546.0 21.50	26.0 1.02	22.7 0.90	2353.6	161.7	0.2299	184.79 407.40
55.562 2.1875	38.100 1.5000	21.1 0.83	3.3 0.13	338.0 13.31	338.0 13.31	3.3 0.13	396.0 15.59	387.0 15.24	3.1 0.12	0.1 0.01	1727.9	396.2	0.1641	14.96 32.97
28.575 1.1250	20.638 0.8125	35.1 1.38	3.5 0.14	333.0 13.11	339.0 13.35	3.3 0.13	373.1 14.69	365.0 14.37	2.8 0.11	2.5 0.10	1500.1	792.5	0.2007	5.30 11.69
63.500 2.5000	44.450 1.7500	15.0 0.59	3.3 0.13	341.8 13.46	343.0 13.50	3.3 0.13	409.0 16.10	400.0 15.75	5.0 0.20	0.5 0.02	1926.3	352.6	0.1679	18.42 40.59
136.525 5.3750	98.425 3.8750	-16.8 -0.66	6.4 0.25	359.0 14.13	369.0 14.53	6.4 0.25	547.4 21.55	534.0 21.02	20.4 0.80	8.2 0.33	3159.0	183.3	0.2053	156.18 344.32

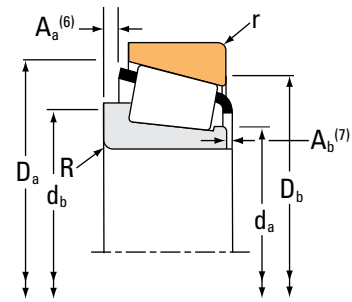
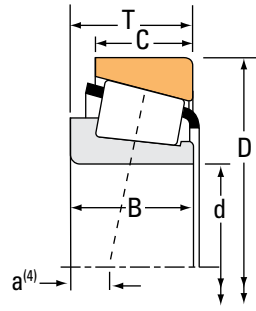
(4) Negative value indicates effective center inside cone (inner-ring) backface.  
 (5) These maximum fillet radii will be cleared by the bearing corners.  
 (6) Negative value indicates cage extends beyond cone (inner-ring) backface.  
 (7) Negative value indicates cage that does not extend beyond cone (inner-ring) front face.

Continued on next page.

# TAPERED ROLLER BEARINGS

## SINGLE-ROW • TYPE TS

### TYPE TS



Bearing Dimensions			Load Ratings							Part Number		
Bore d	O.D. D	Width T	Dynamic <sup>(1)</sup>		Factors <sup>(2)</sup>		Dynamic <sup>(3)</sup>		Factors <sup>(2)</sup>	Static	Inner	Outer
			C <sub>1</sub>	e	Y	C <sub>90</sub>	C <sub>a90</sub>	K	C <sub>0</sub>			
mm in.	mm in.	mm in.	N lbf			N lbf	N lbf			N lbf		
329.870 12.9870	533.400 21.0000	76.200 3.0000	1730000 388000	0.33	1.80	448000 101000	255000 57300	1.76		2500000 562000	EE971298	972100
329.895 12.9880	415.925 16.3750	47.625 1.8750	485000 109000	0.50	1.20	126000 28300	107000 24100	1.17		1180000 266000	L860049A	L860010
330.200 13.0000	415.925 16.3750	47.625 1.8750	485000 109000	0.50	1.20	126000 28300	107000 24100	1.17		1180000 266000	L860049	L860010
330.200 13.0000	415.925 16.3750	47.625 1.8750	485000 109000	0.50	1.20	126000 28300	107000 24100	1.17		1180000 266000	L860048	L860010
330.200 13.0000	469.900 18.5000	60.325 2.3750	628000 141000	0.50	1.20	163000 36600	140000 31400	1.17		1110000 250000	EE161300	161850
330.200 13.0000	482.600 19.0000	60.325 2.3750	628000 141000	0.50	1.20	163000 36600	140000 31400	1.17		1110000 250000	EE161300	161900
330.200 13.0000	482.600 19.0000	66.675 2.6250	1030000 231000	0.42	1.44	266000 59900	190000 42700	1.40		1770000 398000	EE203130	203190
330.200 13.0000	482.600 19.0000	85.725 3.3750	1250000 281000	0.39	1.54	324000 72900	217000 48700	1.49		2320000 523000	EE526130	526190
330.200 13.0000	482.600 19.0000	85.725 3.3750	1250000 281000	0.39	1.54	324000 72900	217000 48700	1.49		2320000 523000	EE526132	526190
333.000 13.1102	415.925 16.3750	47.625 1.8750	485000 109000	0.50	1.20	126000 28300	107000 24100	1.17		1180000 266000	L860049AA	L860010
333.375 13.1250	469.900 18.5000	90.488 3.5625	1600000 360000	0.33	1.79	415000 93200	238000 53400	1.74		3460000 777000	HM261049	HM261010
338.138 13.3125	403.225 15.8750	33.338 1.3125	301000 67700	0.42	1.44	78100 17600	55600 12500	1.40		827000 186000	LL660749A	LL660711
342.900 13.5000	450.850 17.7500	66.675 2.6250	1120000 251000	0.35	1.70	289000 65000	174000 39200	1.66		2210000 497000	LM361649	LM361610
342.900 13.5000	457.098 17.9960	66.675 2.6250	823000 185000	0.71	0.84	213000 48000	260000 58500	0.82		1940000 436000	LM961548	LM961510
342.900 13.5000	457.098 17.9960	68.262 2.6875	823000 185000	0.71	0.84	213000 48000	260000 58500	0.82		1940000 436000	LM961548	LM961511
342.900 13.5000	533.400 21.0000	76.200 3.0000	1730000 388000	0.33	1.80	448000 101000	255000 57300	1.76		2500000 562000	EE971354	972100
343.154 13.5100	450.850 17.7500	66.675 2.6250	1120000 251000	0.35	1.70	289000 65000	174000 39200	1.66		2210000 497000	LM361649A	LM361610

<sup>(1)</sup>Based on 1 x 10<sup>6</sup> revolutions L<sub>10</sub> life, for the ISO life-calculation method.

<sup>(2)</sup>Consult your Timken engineer for instructions on use or review the Timken Engineering Manual on timken.com/catalogs.

<sup>(3)</sup>Based on 90 x 10<sup>6</sup> revolutions L<sub>10</sub> life, for The Timken Company life-calculation method. C<sub>90</sub> and C<sub>a90</sub> are radial and thrust values.



Bearing Dimensions											Geometry Factors			Bearing Weight
Width B	Width C	Eff. Ctr. a <sup>(4)</sup>	Shaft			Housing			Cage		G <sub>1</sub>	G <sub>2</sub>	C <sub>g</sub>	
			Max Shaft Fillet Radius R <sup>(5)</sup>	Backing Shoulder Dia. d <sub>a</sub>	Shoulder Dia. d <sub>b</sub>	Max Housing Fillet Radius r <sup>(5)</sup>	Backing Shoulder Dia. D <sub>a</sub>	Shoulder Dia. D <sub>b</sub>	A <sub>a</sub> <sup>(6)</sup>	A <sub>b</sub> <sup>(7)</sup>				
mm in.	mm in.	mm in.	mm in.	mm in.	mm in.	mm in.	mm in.	mm in.	mm in.	mm in.				kg lbs.
76.200 3.0000	50.800 2.0000	3.8 0.15	4.8 0.19	357.0 14.06	364.0 14.33	3.3 0.13	501.0 19.72	501.0 19.72	10.2 0.40	5.0 0.20	2433.2	282.5	0.1730	61.43 135.43
47.625 1.8750	34.925 1.3750	35.3 1.39	3.5 0.14	345.0 13.58	349.0 13.74	3.3 0.13	402.0 15.83	394.0 15.51	7.3 0.28	0.2 0.01	1823.3	479.1	0.1774	14.11 31.11
47.625 1.8750	34.925 1.3750	35.3 1.39	3.5 0.14	345.0 13.58	349.0 13.74	3.3 0.13	402.0 15.83	394.0 15.51	7.3 0.28	0.2 0.01	1823.3	479.1	0.1774	14.03 30.94
47.625 1.8750	34.925 1.3750	35.3 1.39	12.7 0.50	345.0 13.58	367.0 14.45	3.3 0.13	402.0 15.83	394.0 15.51	7.3 0.28	0.2 0.01	1823.3	479.1	0.1774	13.41 29.57
55.562 2.1875	38.100 1.5000	33.8 1.33	7.0 0.28	356.0 14.02	367.0 14.45	6.4 0.25	455.0 17.91	445.0 17.52	14.4 0.56	3.9 0.16	1730.8	299.6	0.1741	28.82 63.54
55.562 2.1875	38.100 1.5000	33.8 1.33	7.0 0.28	356.0 14.02	367.0 14.45	6.4 0.25	455.0 17.91	451.0 17.76	14.4 0.56	3.9 0.16	1730.8	299.6	0.1741	31.65 69.77
63.500 2.5000	44.450 1.7500	16.3 0.64	6.8 0.27	354.0 13.94	364.0 14.33	6.8 0.27	456.1 17.96	449.0 17.68	15.4 0.60	5.9 0.23	2138.1	336.0	0.1778	35.82 78.97
80.167 3.1562	60.325 2.3750	4.8 0.19	6.4 0.25	351.0 13.82	360.0 14.17	3.3 0.13	454.0 17.87	449.0 17.68	14.5 0.57	3.1 0.13	2283.3	287.2	0.1790	45.20 99.65
80.167 3.1562	60.325 2.3750	4.8 0.19	3.3 0.13	351.0 13.82	354.0 13.94	3.3 0.13	454.0 17.87	449.0 17.68	14.5 0.57	3.1 0.13	2283.3	287.2	0.1790	45.21 99.67
47.625 1.8750	34.925 1.3750	35.3 1.39	3.5 0.14	347.0 13.66	351.0 13.82	3.3 0.13	402.0 15.83	394.0 15.51	7.3 0.28	0.2 0.01	1823.3	479.1	0.1774	13.56 29.88
90.488 3.5625	71.438 2.8125	-6.1 -0.24	6.4 0.25	358.0 14.09	363.0 14.29	3.3 0.13	449.0 17.69	439.0 17.28	7.7 0.30	3.3 0.13	3306.8	324.3	0.1935	48.69 107.32
33.338 1.3125	26.988 1.0625	33.3 1.31	3.3 0.13	350.0 13.78	353.0 13.90	3.3 0.13	394.0 15.51	386.0 15.20	1.9 0.07	1.0 0.04	1790.4	757.8	0.2095	7.63 16.83
66.675 2.6250	52.388 2.0625	8.9 0.35	8.5 0.33	359.0 14.13	373.0 14.69	3.5 0.14	435.0 17.13	425.0 16.73	4.7 0.18	4.9 0.20	2732.7	432.9	0.1833	27.00 59.52
63.500 2.5000	46.038 1.8125	56.4 2.22	3.3 0.13	363.0 14.29	367.0 14.45	3.3 0.13	443.1 17.44	423.0 16.65	12.6 0.49	4.9 0.20	2281.5	300.4	0.2146	28.11 61.97
63.500 2.5000	47.625 1.8750	56.4 2.22	3.3 0.13	363.0 14.29	367.0 14.45	3.3 0.13	443.1 17.44	423.0 16.65	12.6 0.49	4.9 0.20	2281.5	300.4	0.2146	28.57 63.00
76.200 3.0000	50.800 2.0000	3.8 0.15	4.8 0.19	367.0 14.45	373.0 14.69	3.3 0.13	501.0 19.72	501.0 19.72	10.2 0.40	5.0 0.20	2433.2	282.5	0.1730	57.32 126.38
66.675 2.6250	52.388 2.0625	8.9 0.35	8.5 0.33	363.0 14.29	373.0 14.69	3.5 0.14	435.0 17.13	425.0 16.73	4.7 0.18	4.9 0.20	2732.7	432.9	0.1833	26.91 59.32

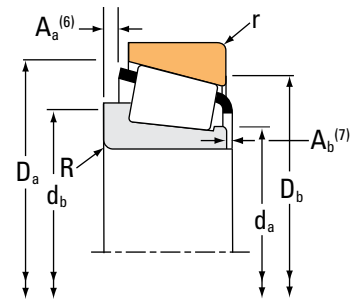
<sup>(4)</sup>Negative value indicates effective center inside cone (inner-ring) backface.  
<sup>(5)</sup>These maximum fillet radii will be cleared by the bearing corners.  
<sup>(6)</sup>Negative value indicates cage extends beyond cone (inner-ring) backface.  
<sup>(7)</sup>Negative value indicates cage that does not extend beyond cone (inner-ring) front face.

Continued on next page.

# TAPERED ROLLER BEARINGS

## SINGLE-ROW • TYPE TS

### TYPE TS



Bearing Dimensions			Load Ratings							Part Number		
Bore d	O.D. D	Width T	Dynamic <sup>(1)</sup> C <sub>1</sub>		Factors <sup>(2)</sup> e Y		Dynamic <sup>(3)</sup> C <sub>90</sub> C <sub>a90</sub>		Factors <sup>(2)</sup> K	Static C <sub>0</sub>	Inner	Outer
mm in.	mm in.	mm in.	N lbf				N lbf	N lbf		N lbf		
346.075 13.6250	469.900 18.5000	60.325 2.3750	628000 141000	0.50	1.20		163000 36600	140000 31400	1.17	1110000 250000	EE161363	161850
346.075 13.6250	482.600 19.0000	60.325 2.3750	628000 141000	0.50	1.20		163000 36600	140000 31400	1.17	1110000 250000	EE161363	161900
346.075 13.6250	482.600 19.0000	66.675 2.6250	1030000 231000	0.42	1.44		266000 59900	190000 42700	1.40	1770000 398000	EE203136	203190
346.075 13.6250	482.600 19.0000	66.675 2.6250	1030000 231000	0.42	1.44		266000 59900	190000 42700	1.40	1770000 398000	EE203137	203190
346.075 13.6250	488.950 19.2500	95.250 3.7500	1730000 388000	0.33	1.79		448000 101000	257000 57700	1.74	3760000 845000	HM262749	HM262710
346.075 13.6250	488.950 19.2500	95.250 3.7500	1860000 419000	0.33	1.79		483000 109000	277000 62300	1.74	3440000 774000	HM262748	HM262710
346.075 13.6250	546.100 21.5000	93.662 3.6875	2690000 604000	0.24	2.46		696000 157000	291000 65500	2.39	3990000 897000	HM164646	HM164615
349.250 13.7500	501.650 19.7500	90.488 3.5625	1350000 304000	0.37	1.63		350000 78700	220000 49500	1.59	2780000 626000	EE333137	333197
354.012 13.9375	469.900 18.5000	60.325 2.3750	548000 123000	0.50	1.20		142000 31900	122000 27400	1.17	1110000 250000	EE161394	161850
354.012 13.9375	482.600 19.0000	60.325 2.3750	548000 123000	0.50	1.20		142000 31900	122000 27400	1.17	1110000 250000	EE161394	161900
355.600 14.0000	444.500 17.5000	60.325 2.3750	733000 165000	0.31	1.95		190000 42700	100000 22500	1.90	1970000 444000	L163149	L163110
355.600 14.0000	469.900 18.5000	60.325 2.3750	628000 141000	0.50	1.20		163000 36600	140000 31400	1.17	1110000 250000	EE161400	161850
355.600 14.0000	482.600 19.0000	60.325 2.3750	628000 141000	0.50	1.20		163000 36600	140000 31400	1.17	1110000 250000	EE161400	161900
355.600 14.0000	488.950 19.2500	60.325 2.3750	628000 141000	0.50	1.20		163000 36600	140000 31400	1.17	1110000 250000	EE161400	161925
355.600 14.0000	501.650 19.7500	74.612 2.9375	1050000 236000	0.44	1.36		273000 61300	206000 46200	1.33	1870000 420000	EE231400	231975
355.600 14.0000	501.650 19.7500	90.488 3.5625	1350000 304000	0.37	1.63		350000 78700	220000 49500	1.59	2780000 626000	EE333140	333197
355.600 14.0000	514.350 20.2500	74.612 2.9375	1050000 236000	0.44	1.36		273000 61300	206000 46200	1.33	1870000 420000	EE231400	232025

<sup>(1)</sup>Based on 1 x 10<sup>6</sup> revolutions L<sub>10</sub> life, for the ISO life-calculation method.

<sup>(2)</sup>Consult your Timken engineer for instructions on use or review the Timken Engineering Manual on timken.com/catalogs.

<sup>(3)</sup>Based on 90 x 10<sup>6</sup> revolutions L<sub>10</sub> life, for The Timken Company life-calculation method. C<sub>90</sub> and C<sub>a90</sub> are radial and thrust values.

Bearing Dimensions											Geometry Factors			Bearing Weight
Width B	Width C	Eff. Ctr. a <sup>(4)</sup>	Shaft			Housing			Cage		G <sub>1</sub>	G <sub>2</sub>	C <sub>g</sub>	
			Max Shaft Fillet Radius R <sup>(5)</sup>	Backing Shoulder Dia. d <sub>a</sub>	Shoulder Dia. d <sub>b</sub>	Max Housing Fillet Radius r <sup>(5)</sup>	Backing Shoulder Dia. D <sub>a</sub>	Shoulder Dia. D <sub>b</sub>	A <sub>a</sub> <sup>(6)</sup>	A <sub>b</sub> <sup>(7)</sup>				
mm in.	mm in.	mm in.	mm in.	mm in.	mm in.	mm in.	mm in.	mm in.	mm in.	mm in.				kg lbs.
55.562 2.1875	38.100 1.5000	33.8 1.33	7.0 0.28	368.0 14.49	379.0 14.92	6.4 0.25	455.0 17.91	445.0 17.52	14.4 0.56	3.9 0.16	1730.8	299.6	0.1741	25.15 55.44
55.562 2.1875	38.100 1.5000	33.8 1.33	7.0 0.28	368.0 14.49	379.0 14.92	6.4 0.25	455.0 17.91	451.0 17.76	14.4 0.56	3.9 0.16	1730.8	299.6	0.1741	27.98 61.67
63.500 2.5000	44.450 1.7500	16.3 0.64	6.8 0.27	366.0 14.41	376.0 14.80	6.8 0.27	456.1 17.96	449.0 17.68	15.4 0.60	5.9 0.23	2138.1	336.0	0.1778	31.62 69.72
63.500 2.5000	44.450 1.7500	16.3 0.64	12.7 0.50	366.0 14.41	388.0 15.28	6.8 0.27	456.1 17.96	449.0 17.68	15.4 0.60	5.9 0.23	2138.1	336.0	0.1778	31.12 68.62
95.250 3.7500	74.612 2.9375	-6.4 -0.25	6.4 0.25	367.0 14.45	377.0 14.84	3.3 0.13	467.0 18.39	456.0 17.95	8.5 0.33	3.5 0.14	3646.2	341.8	0.1999	55.50 122.37
95.250 3.7500	74.612 2.9375	-6.4 -0.25	6.4 0.25	367.0 14.45	377.0 14.84	3.3 0.13	467.0 18.39	456.0 17.95	9.3 0.36	3.0 0.12	3430.8	322.6	0.1956	54.07 119.21
95.250 3.7500	76.200 3.0000	-15.5 -0.61	6.4 0.25	373.0 14.69	383.0 15.08	3.3 0.13	507.0 19.96	507.0 19.96	2.0 0.08	7.5 0.30	3841.3	316.9	0.1827	85.75 189.06
84.138 3.3125	69.850 2.7500	3.6 0.14	6.4 0.25	372.0 14.65	382.0 15.04	3.3 0.13	478.2 18.83	470.0 18.50	12.0 0.47	3.1 0.12	3037.5	334.7	0.1928	52.79 116.40
55.562 2.1875	38.100 1.5000	33.8 1.33	7.0 0.28	374.0 14.72	385.0 15.16	6.4 0.25	455.0 17.91	445.0 17.52	14.4 0.56	3.9 0.16	1730.8	299.6	0.1741	23.24 51.25
55.562 2.1875	38.100 1.5000	33.8 1.33	7.0 0.28	374.0 14.72	385.0 15.16	6.4 0.25	455.0 17.91	451.0 17.76	14.4 0.56	3.9 0.16	1730.8	299.6	0.1741	26.07 57.48
60.325 2.3750	47.625 1.8750	7.1 0.28	3.5 0.14	370.0 14.57	374.0 14.72	3.3 0.13	430.0 16.93	422.0 16.61	5.2 0.20	2.3 0.09	3207.7	621.3	0.1838	20.64 45.51
55.562 2.1875	38.100 1.5000	33.8 1.33	7.0 0.28	375.0 14.76	386.0 15.20	6.4 0.25	455.0 17.91	445.0 17.52	14.4 0.56	3.9 0.16	1730.8	299.6	0.1741	22.86 50.40
55.562 2.1875	38.100 1.5000	33.8 1.33	7.0 0.28	375.0 14.76	386.0 15.20	6.4 0.25	455.0 17.91	451.0 17.76	14.4 0.56	3.9 0.16	1730.8	299.6	0.1741	25.69 56.63
55.562 2.1875	38.100 1.5000	33.8 1.33	7.0 0.28	375.0 14.76	386.0 15.20	6.4 0.25	455.0 17.91	453.0 17.83	14.4 0.56	3.9 0.16	1730.8	299.6	0.1741	27.13 59.80
66.675 2.6250	50.800 2.0000	19.6 0.77	6.4 0.25	379.0 14.92	388.0 15.28	3.3 0.13	481.1 18.94	472.0 18.58	18.9 0.74	6.0 0.24	2386.0	366.8	0.1874	39.16 86.35
84.138 3.3125	69.850 2.7500	3.6 0.14	6.4 0.25	377.0 14.84	387.0 15.24	3.3 0.13	478.2 18.83	470.0 18.50	12.0 0.47	3.1 0.12	3037.5	334.7	0.1928	50.47 111.29
66.675 2.6250	50.800 2.0000	19.6 0.77	6.4 0.25	379.0 14.92	388.0 15.28	3.3 0.13	481.1 18.94	478.0 18.82	18.9 0.74	6.0 0.24	2386.0	366.8	0.1874	43.13 95.08

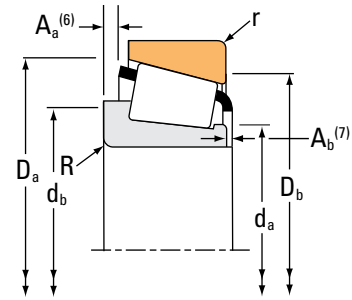
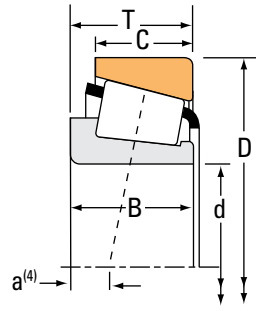
<sup>(4)</sup>Negative value indicates effective center inside cone (inner-ring) backface.  
<sup>(5)</sup>These maximum fillet radii will be cleared by the bearing corners.  
<sup>(6)</sup>Negative value indicates cage extends beyond cone (inner-ring) backface.  
<sup>(7)</sup>Negative value indicates cage that does not extend beyond cone (inner-ring) front face.

Continued on next page.

# TAPERED ROLLER BEARINGS

## SINGLE-ROW • TYPE TS

### TYPE TS



Bearing Dimensions			Load Ratings							Part Number		
Bore d	O.D. D	Width T	Dynamic <sup>(1)</sup> C <sub>1</sub>		Factors <sup>(2)</sup> e Y		Dynamic <sup>(3)</sup> C <sub>90</sub> C <sub>a90</sub>		Factors <sup>(2)</sup> K	Static C <sub>0</sub>	Inner	Outer
			N	lbf	N	lbf	N	lbf	N	lbf		
355.600 14.0000	673.100 26.5000	152.400 6.0000	3690000 830000		0.38	1.60	957000 215000	616000 138000	1.55	6140000 1380000	EE121140	121265
360.400 14.1890	510.000 20.0787	88.000 3.4646	1870000 421000		0.31	1.95	485000 109000	255000 57300	1.90	3550000 798000	NP771673	NP725758
361.950 14.2500	406.400 16.0000	23.812 0.9375	198000 44500		0.40	1.49	51300 11500	35300 7940	1.45	574000 129000	LL562749	LL562710
368.249 14.4980	523.875 20.6250	101.600 4.0000	2270000 511000		0.33	1.80	589000 132000	335000 75400	1.76	4340000 977000	HM265049	HM265010
368.300 14.5000	596.900 23.5000	95.250 3.7500	1770000 399000		0.41	1.45	460000 103000	326000 73400	1.41	3030000 680000	EE181453	182350
368.300 14.5000	609.600 24.0000	142.875 5.6250	2970000 668000		0.36	1.68	770000 173000	470000 106000	1.64	5380000 1210000	EE321145	321240
368.300 14.5000	622.300 24.5000	142.875 5.6250	2970000 668000		0.36	1.68	770000 173000	470000 106000	1.64	5380000 1210000	EE321145	321245
371.475 14.6250	501.650 19.7500	74.612 2.9375	1050000 236000		0.44	1.36	273000 61300	206000 46200	1.33	1870000 420000	EE231462	231975
371.475 14.6250	514.350 20.2500	74.612 2.9375	1050000 236000		0.44	1.36	273000 61300	206000 46200	1.33	1870000 420000	EE231462	232025
374.650 14.7500	431.800 17.0000	28.575 1.1250	254000 57100		0.33	1.80	65800 14800	37500 8430	1.76	745000 167000	LL264648	LL264610
374.650 14.7500	522.288 20.5625	85.725 3.3750	1390000 313000		0.39	1.56	360000 81000	238000 53500	1.51	2950000 663000	LM565943	LM565910
377.825 14.8750	508.000 20.0000	63.500 2.5000	755000 170000		0.53	1.13	196000 44000	179000 40200	1.10	1480000 332000	EE192148	192200
377.825 14.8750	522.288 20.5625	85.725 3.3750	1390000 313000		0.39	1.56	360000 81000	238000 53500	1.51	2950000 663000	LM565946	LM565910
381.000 15.0000	479.425 18.8750	49.212 1.9375	594000 133000		0.50	1.21	154000 34600	130000 29300	1.18	1380000 311000	L865547	L865512
381.000 15.0000	479.425 18.8750	49.212 1.9375	594000 133000		0.50	1.21	154000 34600	130000 29300	1.18	1380000 311000	L865548	L865512
381.000 15.0000	508.000 20.0000	63.500 2.5000	755000 170000		0.53	1.13	196000 44000	179000 40200	1.10	1480000 332000	EE192150	192200
381.000 15.0000	522.288 20.5625	85.725 3.3750	1390000 313000		0.39	1.56	360000 81000	238000 53500	1.51	2950000 663000	LM565949	LM565910

<sup>(1)</sup>Based on 1 x 10<sup>6</sup> revolutions L<sub>10</sub> life, for the ISO life-calculation method.

<sup>(2)</sup>Consult your Timken engineer for instructions on use or review the Timken Engineering Manual on timken.com/catalogs.

<sup>(3)</sup>Based on 90 x 10<sup>6</sup> revolutions L<sub>10</sub> life, for The Timken Company life-calculation method. C<sub>90</sub> and C<sub>a90</sub> are radial and thrust values.

Bearing Dimensions											Geometry Factors			Bearing Weight
Width B	Width C	Eff. Ctr. a <sup>(4)</sup>	Shaft			Housing			Cage		G <sub>1</sub>	G <sub>2</sub>	C <sub>g</sub>	
			Max Shaft Fillet Radius R <sup>(5)</sup>	Backing Shoulder Dia. d <sub>a</sub>	Shoulder Dia. d <sub>b</sub>	Max Housing Fillet Radius r <sup>(5)</sup>	Backing Shoulder Dia. D <sub>a</sub>	Shoulder Dia. D <sub>b</sub>	A <sub>a</sub> <sup>(6)</sup>	A <sub>b</sub> <sup>(7)</sup>				
mm in.	mm in.	mm in.	mm in.	mm in.	mm in.	mm in.	mm in.	mm in.	mm in.	mm in.				kg lbs.
152.400 6.0000	114.300 4.5000	-24.4 -0.96	16.0 0.63	396.0 15.59	425.0 16.73	6.4 0.25	611.8 24.09	603.0 23.74	21.8 0.85	6.7 0.27	4540.6	230.6	0.2231	235.18 518.47
103.000 4.0551	72.000 2.8346	-4.1 -0.16	6.0 0.24	382.0 15.04	391.0 15.39	2.5 0.10	481.0 18.94	473.0 18.62	4.9 0.19	4.9 0.19	3826.7	375.8	0.1968	58.62 129.23
23.812 0.9375	17.462 0.6875	37.8 1.49	2.3 0.09	371.0 14.61	372.0 14.65	1.5 0.06	401.0 15.79	396.0 15.59	1.0 0.04	2.4 0.10	1673.0	1063.8	0.2005	3.69 8.13
101.600 4.0000	79.375 3.1250	-8.4 -0.33	6.4 0.25	394.0 15.51	400.0 15.75	6.4 0.25	499.0 19.63	487.0 19.17	9.2 0.36	3.7 0.15	4297.3	412.9	0.2106	69.20 152.56
92.075 3.6250	60.325 2.3750	9.4 0.37	9.7 0.38	402.0 15.83	415.0 16.34	6.4 0.25	552.0 21.73	552.0 21.73	18.5 0.72	6.8 0.27	2961.8	271.9	0.1984	90.79 200.17
139.700 5.5000	111.125 4.3750	-23.6 -0.93	8.0 0.31	404.0 15.91	413.0 16.26	6.4 0.25	571.0 22.48	555.0 21.85	21.1 0.83	4.9 0.20	4401.5	304.6	0.2173	156.49 345.01
139.700 5.5000	111.125 4.3750	-23.6 -0.93	8.0 0.31	404.0 15.91	413.0 16.26	6.4 0.25	571.0 22.48	561.0 22.09	21.1 0.83	4.9 0.20	4401.5	304.6	0.2173	167.16 368.54
66.675 2.6250	50.800 2.0000	19.6 0.77	6.4 0.25	390.0 15.35	400.0 15.75	3.3 0.13	481.1 18.94	472.0 18.58	18.9 0.74	6.0 0.24	2386.0	366.8	0.1874	34.43 75.91
66.675 2.6250	50.800 2.0000	19.6 0.77	6.4 0.25	390.0 15.35	400.0 15.75	3.3 0.13	481.1 18.94	478.0 18.82	18.9 0.74	6.0 0.24	2386.0	366.8	0.1874	38.40 84.65
28.575 1.1250	20.638 0.8125	27.9 1.10	3.5 0.14	384.0 15.12	389.0 15.31	3.3 0.13	424.0 16.69	417.0 16.42	1.9 0.07	3.0 0.12	2155.1	1055.1	0.2055	6.08 13.41
84.138 3.3125	61.912 2.4375	8.9 0.35	6.4 0.25	397.0 15.63	407.0 16.02	3.3 0.13	499.5 19.67	493.0 19.41	12.3 0.48	3.2 0.13	3379.9	375.8	0.2028	51.91 114.42
58.738 2.3125	38.100 1.5000	39.4 1.55	6.4 0.25	398.0 15.67	408.0 16.06	3.3 0.13	482.0 18.98	478.0 18.82	17.9 0.70	4.0 0.16	2288.0	398.1	0.1951	30.27 66.73
84.138 3.3125	61.912 2.4375	8.9 0.35	6.4 0.25	399.0 15.71	409.0 16.10	3.3 0.13	499.5 19.67	493.0 19.41	12.3 0.48	3.2 0.13	3379.9	375.8	0.2028	50.67 111.69
47.625 1.8750	34.925 1.3750	42.9 1.69	6.4 0.25	395.0 15.55	407.0 16.02	3.3 0.13	465.0 18.31	456.0 17.95	6.6 0.26	2.8 0.11	2256.6	529.8	0.1897	18.56 40.92
47.625 1.8750	34.925 1.3750	42.9 1.69	12.7 0.50	395.0 15.55	419.0 16.50	3.3 0.13	465.0 18.31	456.0 17.95	6.6 0.26	2.8 0.11	2256.6	529.8	0.1897	18.31 40.37
58.738 2.3125	38.100 1.5000	39.4 1.55	6.4 0.25	400.0 15.75	410.0 16.14	3.3 0.13	482.0 18.98	478.0 18.82	17.9 0.70	4.0 0.16	2288.0	398.1	0.1951	29.40 64.81
84.138 3.3125	61.912 2.4375	8.9 0.35	6.4 0.25	402.0 15.83	411.0 16.18	3.3 0.13	499.5 19.67	493.0 19.41	12.3 0.48	3.2 0.13	3379.9	375.8	0.2028	49.47 109.05

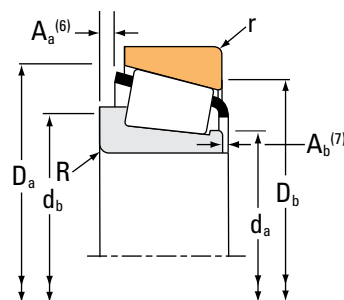
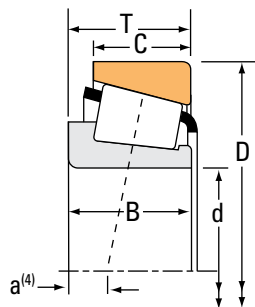
<sup>(4)</sup>Negative value indicates effective center inside cone (inner-ring) backface.  
<sup>(5)</sup>These maximum fillet radii will be cleared by the bearing corners.  
<sup>(6)</sup>Negative value indicates cage extends beyond cone (inner-ring) backface.  
<sup>(7)</sup>Negative value indicates cage that does not extend beyond cone (inner-ring) front face.

Continued on next page.

# TAPERED ROLLER BEARINGS

## SINGLE-ROW • TYPE TS

### TYPE TS



Bearing Dimensions			Load Ratings							Part Number			
Bore d	O.D. D	Width T	Dynamic <sup>(1)</sup>		Factors <sup>(2)</sup>		Dynamic <sup>(3)</sup>		Factors <sup>(2)</sup>		Static C <sub>0</sub>	Inner	Outer
			C <sub>1</sub>	e	Y	C <sub>90</sub>	C <sub>a90</sub>	K	N	N			
mm in.	mm in.	mm in.	N lbf			N lbf	N lbf		N lbf				
381.000 15.0000	546.100 21.5000	104.775 4.1250	2460000 553000	0.33	1.80	638000 143000	363000 81700	1.76	4730000 1060000		HM266447	HM266410	
381.000 15.0000	546.100 21.5000	104.775 4.1250	2270000 510000	0.33	1.80	588000 132000	335000 75200	1.76	4210000 946000		HM266446	HM266410	
381.000 15.0000	590.550 23.2500	114.300 4.5000	2860000 642000	0.33	1.80	740000 166000	421000 94800	1.76	5550000 1250000		M268730	M268710	
384.175 15.1250	441.325 17.3750	28.575 1.1250	232000 52300	0.34	1.76	60300 13500	35100 7890	1.72	667000 150000		LL365348	LL365310	
384.175 15.1250	546.100 21.5000	104.774 4.1250	2270000 510000	0.33	1.80	588000 132000	335000 75200	1.76	4210000 946000		HM266448	HM266410	
384.175 15.1250	546.100 21.5000	104.775 4.1250	2460000 553000	0.33	1.80	638000 143000	363000 81700	1.76	4730000 1060000		HM266449	HM266410	
385.762 15.1875	514.350 20.2500	82.550 3.2500	1350000 304000	0.42	1.43	351000 78900	251000 56500	1.40	3160000 710000		LM665949	LM665910	
387.248 15.2460	546.100 21.5000	87.312 3.4375	1870000 420000	0.42	1.44	484000 109000	346000 77800	1.40	3940000 886000		M667935	M667911	
393.700 15.5000	546.100 21.5000	76.200 3.0000	1090000 244000	0.48	1.26	282000 63300	230000 51600	1.23	2010000 451000		EE234154	234215	
396.875 15.6250	546.100 21.5000	76.200 3.0000	1090000 244000	0.48	1.26	282000 63300	230000 51600	1.23	2010000 451000		EE234156	234215	
396.875 15.6250	558.800 22.0000	65.088 2.5625	1090000 244000	0.48	1.26	282000 63300	230000 51600	1.23	2010000 451000		EE234156	234220	
400.000 15.7480	676.000 26.6142	152.400 6.0000	3770000 847000	0.79	0.76	976000 219000	1320000 298000	0.74	6470000 1450000		NP741069	NP263541	
403.225 15.8750	460.375 18.1250	28.575 1.1250	230000 51700	0.40	1.49	59600 13400	41000 9210	1.45	708000 159000		LL566848	LL566810	
406.400 16.0000	508.000 20.0000	61.912 2.4375	859000 193000	0.37	1.64	223000 50100	139000 31300	1.60	2230000 502000		L467549	L467510	
406.400 16.0000	546.100 21.5000	76.200 3.0000	1090000 244000	0.48	1.26	282000 63300	230000 51600	1.23	2010000 451000		EE234160	234215	
406.400 16.0000	546.100 21.5000	76.200 3.0000	1090000 244000	0.48	1.26	282000 63300	230000 51600	1.23	2010000 451000		EE234160A	234215X	
406.400 16.0000	546.100 21.5000	87.312 3.4375	1870000 420000	0.42	1.44	484000 109000	346000 77800	1.40	3940000 886000		M667944	M667911	

<sup>(1)</sup>Based on 1 x 10<sup>6</sup> revolutions L<sub>10</sub> life, for the ISO life-calculation method.

<sup>(2)</sup>Consult your Timken engineer for instructions on use or review the Timken Engineering Manual on timken.com/catalogs.

<sup>(3)</sup>Based on 90 x 10<sup>6</sup> revolutions L<sub>10</sub> life, for The Timken Company life-calculation method. C<sub>90</sub> and C<sub>a90</sub> are radial and thrust values.

Bearing Dimensions											Geometry Factors			Bearing Weight
Width B	Width C	Eff. Ctr. a <sup>(4)</sup>	Shaft			Housing			Cage		G <sub>1</sub>	G <sub>2</sub>	C <sub>g</sub>	
			Max Shaft Fillet Radius R <sup>(5)</sup>	Backing Shoulder Dia. d <sub>a</sub> d <sub>b</sub>		Max Housing Fillet Radius r <sup>(5)</sup>	Backing Shoulder Dia. D <sub>a</sub> D <sub>b</sub>		A <sub>a</sub> <sup>(6)</sup>	A <sub>b</sub> <sup>(7)</sup>				
mm in.	mm in.	mm in.	mm in.	mm in.	mm in.	mm in.	mm in.	mm in.	mm in.	mm in.			kg lbs.	
104.775 4.1250	82.550 3.2500	-7.1 -0.28	6.4 0.25	405.0 15.94	415.0 16.34	6.4 0.25	520.0 20.47	507.0 19.96	8.8 0.34	4.9 0.20	4760.1	301.5	0.2178	79.35 174.93
104.775 4.1250	82.550 3.2500	-7.1 -0.28	6.4 0.25	405.0 15.94	415.0 16.34	6.4 0.25	520.0 20.47	507.0 19.96	9.0 0.35	5.5 0.22	4383.4	278.7	0.2116	76.11 167.79
114.300 4.5000	88.900 3.5000	-9.4 -0.37	6.4 0.25	415.0 16.34	425.0 16.73	6.4 0.25	562.4 22.14	548.9 21.61	10.6 0.41	6.0 0.24	5754.9	420.9	0.2319	118.82 261.95
28.575 1.1250	20.638 0.8125	30.0 1.18	3.5 0.14	393.0 15.47	398.0 15.67	3.3 0.13	433.0 17.05	427.0 16.81	1.4 0.05	3.2 0.13	2056.5	1165.0	0.2033	6.23 13.74
104.775 4.1250	82.550 3.2500	-7.1 -0.28	6.4 0.25	407.0 16.02	417.0 16.42	6.4 0.25	520.0 20.47	507.0 19.96	9.0 0.35	5.5 0.22	4383.4	278.7	0.2116	74.41 164.05
104.775 4.1250	82.550 3.2500	-7.1 -0.28	6.4 0.25	407.0 16.02	417.0 16.42	6.4 0.25	520.0 20.47	507.0 19.96	8.8 0.34	4.9 0.20	4760.1	301.5	0.2178	77.78 171.48
82.550 3.2500	63.500 2.5000	16.3 0.64	6.4 0.25	406.0 15.98	415.0 16.34	3.3 0.13	495.0 19.49	482.0 18.98	9.4 0.37	2.9 0.12	3743.4	480.0	0.2155	45.18 99.61
87.312 3.4375	68.262 2.6875	17.8 0.70	6.4 0.25	414.0 16.30	424.0 16.69	6.4 0.25	526.7 20.74	510.0 20.08	8.0 0.31	2.7 0.11	4639.7	498.9	0.2316	65.33 144.04
61.120 2.4063	55.562 2.1875	35.6 1.40	6.4 0.25	416.0 16.38	426.0 16.77	6.4 0.25	515.6 20.30	504.0 19.84	13.8 0.54	6.1 0.24	2782.9	448.6	0.2018	44.77 98.69
61.120 2.4063	55.562 2.1875	35.6 1.40	6.4 0.25	418.0 16.46	428.0 16.85	6.4 0.25	515.6 20.30	504.0 19.84	13.8 0.54	6.1 0.24	2782.9	448.6	0.2018	43.83 96.61
61.120 2.4063	44.450 1.7500	35.6 1.40	6.4 0.25	418.0 16.46	428.0 16.85	6.4 0.25	516.0 20.31	516.0 20.31	13.8 0.54	6.1 0.24	2782.9	448.6	0.2018	43.25 95.34
148.000 5.8268	103.000 4.0551	54.1 2.13	6.4 0.25	448.0 17.64	481.0 18.94	6.4 0.25	642.0 25.28	591.0 23.27	21.4 0.84	11.3 0.45	4979.1	257.9	0.2897	215.02 474.07
28.575 1.1250	20.638 0.8125	41.4 1.63	3.5 0.14	414.0 16.30	418.0 16.46	3.3 0.13	452.0 17.80	445.0 17.52	2.0 0.08	2.0 0.08	2302.0	1585.3	0.2225	6.40 14.11
61.912 2.4375	47.625 1.8750	20.3 0.80	3.3 0.13	423.0 16.65	426.0 16.77	3.3 0.13	492.0 19.37	483.0 19.02	6.1 0.24	2.8 0.11	3716.5	673.8	0.2038	27.06 59.66
61.120 2.4063	55.562 2.1875	35.6 1.40	6.4 0.25	425.0 16.73	435.0 17.13	6.4 0.25	515.6 20.30	504.0 19.84	13.8 0.54	6.1 0.24	2782.9	448.6	0.2018	41.06 90.51
61.120 2.4063	55.562 2.1875	35.6 1.40	6.8 0.27	425.0 16.73	435.0 17.13	6.8 0.27	515.6 20.30	504.0 19.84	13.8 0.54	6.1 0.24	2782.9	448.6	0.2018	41.23 90.89
87.312 3.4375	68.262 2.6875	17.8 0.70	6.4 0.25	428.0 16.85	438.0 17.24	6.4 0.25	526.7 20.74	510.0 20.08	8.0 0.31	2.2 0.09	4639.7	498.9	0.2316	57.17 126.05

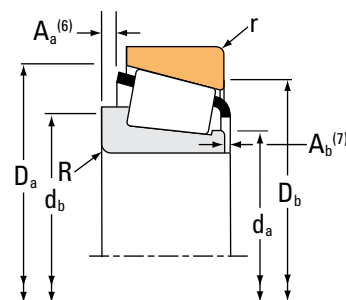
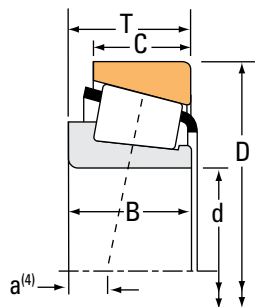
<sup>(4)</sup>Negative value indicates effective center inside cone (inner-ring) backface.  
<sup>(5)</sup>These maximum fillet radii will be cleared by the bearing corners.  
<sup>(6)</sup>Negative value indicates cage extends beyond cone (inner-ring) backface.  
<sup>(7)</sup>Negative value indicates cage that does not extend beyond cone (inner-ring) front face.

Continued on next page.

# TAPERED ROLLER BEARINGS

## SINGLE-ROW • TYPE TS

### TYPE TS



Bearing Dimensions			Load Ratings							Part Number			
Bore d	O.D. D	Width T	Dynamic <sup>(1)</sup>		Factors <sup>(2)</sup>		Dynamic <sup>(3)</sup>		Factors <sup>(2)</sup>		Static C <sub>0</sub>	Inner	Outer
			C <sub>1</sub>	e	Y	C <sub>90</sub>	C <sub>a90</sub>	K	N	N			
mm in.	mm in.	mm in.	N lbf			N lbf	N lbf		N lbf				
406.400 16.0000	549.275 21.6250	85.725 3.3750	1430000 322000	0.41	1.47	371000 83500	259000 58200	1.43	3130000 704000			LM567949	LM567910
406.400 16.0000	558.800 22.0000	65.088 2.5625	1090000 244000	0.48	1.26	282000 63300	230000 51600	1.23	2010000 451000			EE234160	234220
406.400 16.0000	574.675 22.6250	76.200 3.0000	1110000 249000	0.50	1.21	287000 64600	245000 55000	1.17	2100000 471000			EE285160	285226
406.400 16.0000	609.524 23.9970	82.550 3.2500	1720000 387000	0.35	1.73	446000 100000	265000 59600	1.68	3420000 769000			EE736160	736238
406.400 16.0000	609.524 23.9970	87.312 3.4375	1720000 387000	0.35	1.73	446000 100000	265000 59600	1.68	3420000 769000			EE736160	736237
406.400 16.0000	609.600 24.0000	92.075 3.6250	1840000 414000	0.38	1.57	477000 107000	313000 70400	1.52	2870000 645000			EE911600	912400
406.400 16.0000	673.100 26.5000	88.900 3.5000	2040000 458000	0.40	1.49	528000 119000	363000 81700	1.45	3370000 758000			EE571602	572650
406.400 16.0000	762.000 30.0000	180.975 7.1250	4180000 941000	0.94	0.64	1080000 244000	1740000 391000	0.62	6840000 1540000			H969249	H969210
409.575 16.1250	546.100 21.5000	87.312 3.4375	1690000 380000	0.42	1.44	438000 98500	313000 70400	1.40	3420000 768000			M667948	M667911
409.575 16.1250	574.675 22.6250	76.200 3.0000	1110000 249000	0.50	1.21	287000 64600	245000 55000	1.17	2100000 471000			EE285162	285226
411.162 16.1875	609.600 24.0000	92.075 3.6250	1840000 414000	0.38	1.57	477000 107000	313000 70400	1.52	2870000 645000			EE911618	912400
415.925 16.3750	590.550 23.2500	114.300 4.5000	2860000 642000	0.33	1.80	740000 166000	421000 94800	1.76	5550000 1250000			M268749	M268710
419.989 16.5350	590.550 23.2500	114.300 4.5000	2860000 642000	0.33	1.80	740000 166000	421000 94800	1.76	5550000 1250000			M268742	M268710
425.450 16.7500	685.698 26.9960	142.875 5.6250	3130000 704000	0.40	1.49	812000 183000	559000 126000	1.45	6030000 1360000			EE328167	328269
425.450 16.7500	700.000 27.5591	150.076 5.9085	3130000 704000	0.40	1.49	812000 183000	559000 126000	1.45	6030000 1360000			NP035656	NP054313
427.038 16.8125	533.400 21.0000	50.800 2.0000	792000 178000	0.33	1.80	205000 46200	117000 26300	1.76	1760000 396000			L269140	L269110
430.212 16.9375	603.250 23.7500	76.200 3.0000	1130000 253000	0.52	1.14	292000 65700	262000 59000	1.11	2190000 491000			EE241693	242375

<sup>(1)</sup>Based on 1 x 10<sup>6</sup> revolutions L<sub>10</sub> life, for the ISO life-calculation method.

<sup>(2)</sup>Consult your Timken engineer for instructions on use or review the Timken Engineering Manual on timken.com/catalogs.

<sup>(3)</sup>Based on 90 x 10<sup>6</sup> revolutions L<sub>10</sub> life, for The Timken Company life-calculation method. C<sub>90</sub> and C<sub>a90</sub> are radial and thrust values.



Bearing Dimensions											Geometry Factors			Bearing Weight
Width B	Width C	Eff. Ctr. a <sup>(4)</sup>	Shaft			Housing			Cage		G <sub>1</sub>	G <sub>2</sub>	C <sub>g</sub>	
			Max Shaft Fillet Radius R <sup>(5)</sup>	Backing Shoulder Dia. d <sub>a</sub>	mm in.	Max Housing Fillet Radius r <sup>(5)</sup>	Backing Shoulder Dia. D <sub>a</sub>	mm in.	A <sub>a</sub> <sup>(6)</sup>	A <sub>b</sub> <sup>(7)</sup>				
mm in.	mm in.	mm in.	mm in.	mm in.	mm in.	mm in.	mm in.	mm in.	mm in.	mm in.			kg lbs.	
84.138 3.3125	61.912 2.4375	15.5 0.61	6.4 0.25	427.0 16.81	437.0 17.20	3.3 0.13	526.3 20.72	519.0 20.43	12.7 0.50	3.2 0.13	3796.2	424.8	0.2143	52.80 116.40
61.120 2.4063	44.450 1.7500	35.6 1.40	6.4 0.25	425.0 16.73	435.0 17.13	6.4 0.25	516.0 20.31	516.0 20.31	13.8 0.54	6.1 0.24	2782.9	448.6	0.2018	40.48 89.24
67.866 2.6719	50.800 2.0000	38.6 1.52	6.8 0.27	431.0 16.97	442.0 17.40	3.3 0.13	535.6 21.09	534.0 21.02	17.7 0.69	3.0 0.12	3036.6	478.1	0.2103	52.88 116.55
79.375 3.1250	60.325 2.3750	13.5 0.53	8.0 0.31	437.0 17.20	449.0 17.68	6.4 0.25	576.1 22.68	570.0 22.44	9.2 0.36	6.4 0.25	4176.8	536.6	0.2096	81.06 178.70
79.375 3.1250	65.088 2.5625	13.5 0.53	8.0 0.31	437.0 17.20	449.0 17.68	6.4 0.25	576.1 22.68	570.0 22.44	9.2 0.36	6.4 0.25	4176.8	536.6	0.2096	83.18 183.38
84.138 3.3125	60.325 2.3750	11.9 0.47	6.8 0.27	439.0 17.28	443.0 17.44	6.4 0.25	570.0 22.44	567.0 22.32	18.4 0.72	6.3 0.25	3251.1	349.1	0.1990	77.77 171.48
87.833 3.4580	60.325 2.3750	20.3 0.80	6.4 0.25	447.0 17.60	453.0 17.83	3.3 0.13	632.6 24.91	630.0 24.80	14.9 0.59	5.5 0.22	3621.0	321.8	0.2093	101.96 224.80
161.925 6.3750	107.950 4.2500	79.2 3.12	12.7 0.50	463.3 18.24	513.0 20.20	12.7 0.50	719.3 28.32	657.0 25.87	25.8 1.01	20.6 0.81	4614.9	207.4	0.2945	331.83 731.56
87.312 3.4375	68.262 2.6875	17.8 0.70	6.4 0.25	431.0 16.97	440.0 17.32	6.4 0.25	526.7 20.74	510.0 20.08	9.4 0.37	3.1 0.13	4197.4	453.5	0.2235	53.65 118.30
67.866 2.6719	50.800 2.0000	38.6 1.52	6.8 0.27	433.0 17.05	444.0 17.48	3.3 0.13	535.6 21.09	534.0 21.02	17.7 0.69	3.0 0.12	3036.6	478.1	0.2103	51.79 114.17
84.138 3.3125	60.325 2.3750	11.9 0.47	6.8 0.27	443.0 17.44	447.0 17.60	6.4 0.25	570.0 22.44	567.0 22.32	18.4 0.72	6.3 0.25	3251.1	349.1	0.1990	77.16 170.14
114.300 4.5000	88.900 3.5000	-9.4 -0.37	6.4 0.25	441.0 17.36	451.0 17.76	6.4 0.25	562.4 22.14	548.9 21.61	10.6 0.41	6.0 0.24	5754.9	420.9	0.2319	99.09 218.45
114.300 4.5000	88.900 3.5000	-9.4 -0.37	1.5 0.06	444.0 17.48	444.0 17.48	6.4 0.25	562.4 22.14	548.9 21.61	10.6 0.41	6.0 0.24	5754.9	420.9	0.2319	97.05 213.94
142.800 5.6220	104.775 4.1250	-8.1 -0.32	12.7 0.50	463.0 18.23	482.0 18.98	6.4 0.25	636.1 25.04	624.0 24.57	21.6 0.85	3.1 0.13	5606.6	353.0	0.2443	190.51 420.03
150.000 5.9055	104.775 4.1250	-15.2 -0.60	12.7 0.50	463.0 18.23	482.0 18.98	6.4 0.25	636.5 25.06	630.0 24.80	31.1 1.22	0.7 0.03	5606.6	353.0	0.2443	209.26 461.36
50.800 2.0000	36.512 1.4375	25.9 1.02	3.3 0.13	442.0 17.40	447.0 17.60	3.3 0.13	522.0 20.55	516.0 20.31	0.0 0.00	0.0 0.00	3088.3	671.4	0.1850	24.17 53.25
73.025 2.8750	50.800 2.0000	47.0 1.85	6.4 0.25	455.0 17.91	465.0 18.31	6.4 0.25	562.8 22.16	558.0 21.97	18.7 0.73	-1.5 -0.05	3353.8	551.6	0.2207	58.84 129.71

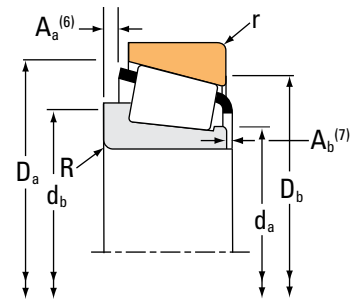
(4) Negative value indicates effective center inside cone (inner-ring) backface.  
 (5) These maximum fillet radii will be cleared by the bearing corners.  
 (6) Negative value indicates cage extends beyond cone (inner-ring) backface.  
 (7) Negative value indicates cage that does not extend beyond cone (inner-ring) front face.

Continued on next page.

# TAPERED ROLLER BEARINGS

## SINGLE-ROW • TYPE TS

### TYPE TS



Bearing Dimensions			Load Ratings							Part Number		
Bore d	O.D. D	Width T	Dynamic <sup>(1)</sup>		Factors <sup>(2)</sup>		Dynamic <sup>(3)</sup>		Factors <sup>(2)</sup>	Static	Inner	Outer
			C <sub>1</sub>	e	Y	C <sub>90</sub>	C <sub>a90</sub>	K	C <sub>0</sub>			
mm in.	mm in.	mm in.	N lbf			N lbf	N lbf			N lbf		
431.800 17.0000	533.400 21.0000	46.038 1.8125	624000 140000	0.31	1.96	162000 36400	84700 19000	1.91	1520000 342000		80385	80325
431.800 17.0000	533.400 21.0000	50.800 2.0000	792000 178000	0.33	1.80	205000 46200	117000 26300	1.76	1760000 396000		L269143	L269110
431.800 17.0000	552.450 21.7500	44.450 1.7500	626000 141000	0.32	1.88	162000 36500	88600 19900	1.83	1550000 348000		80170	80217
431.800 17.0000	565.150 22.2500	44.450 1.7500	626000 141000	0.32	1.88	162000 36500	88600 19900	1.83	1550000 348000		80170	80222
431.800 17.0000	571.500 22.5000	74.612 2.9375	1230000 276000	0.55	1.10	319000 71700	298000 67000	1.07	2810000 632000		LM869448	LM869410
431.800 17.0000	603.250 23.7500	76.200 3.0000	1130000 253000	0.52	1.14	292000 65700	262000 59000	1.11	2190000 491000		EE241701	242375
431.800 17.0000	673.100 26.5000	88.900 3.5000	2040000 458000	0.40	1.49	528000 119000	363000 81700	1.45	3370000 758000		EE571703	572650
431.902 17.0040	685.698 26.9960	177.800 7.0000	4640000 1040000	0.32	1.85	1200000 270000	669000 150000	1.80	9230000 2080000		EE650170	650270
441.325 17.3750	660.400 26.0000	91.280 3.5937	1760000 396000	0.37	1.60	457000 103000	292000 65700	1.56	3630000 816000		EE737173	737260
444.500 17.5000	635.000 25.0000	120.650 4.7500	3280000 736000	0.33	1.80	849000 191000	484000 109000	1.76	6430000 1450000		M270744	M270710
447.675 17.6250	552.450 21.7500	44.450 1.7500	626000 141000	0.32	1.88	162000 36500	88600 19900	1.83	1550000 348000		80176	80217
447.675 17.6250	552.450 21.7500	44.450 1.7500	618000 139000	0.36	1.65	160000 36000	100000 22500	1.60	1510000 340000		LL469949	LL469910
447.675 17.6250	565.150 22.2500	44.450 1.7500	626000 141000	0.32	1.88	162000 36500	88600 19900	1.83	1550000 348000		80176	80222
447.675 17.6250	635.000 25.0000	120.650 4.7500	3280000 736000	0.33	1.80	849000 191000	484000 109000	1.76	6430000 1450000		M270749	M270710
450.850 17.7500	603.250 23.7500	85.725 3.3750	1490000 335000	0.45	1.32	386000 86800	300000 67300	1.29	3440000 773000		LM770945	LM770910
457.073 17.9950	573.088 22.5625	74.612 2.9375	1230000 277000	0.40	1.49	319000 71700	220000 49400	1.45	3170000 713000		L570648	L570610
457.200 18.0000	552.450 21.7500	44.450 1.7500	626000 141000	0.32	1.88	162000 36500	88600 19900	1.83	1550000 348000		80180	80217

<sup>(1)</sup>Based on 1 x 10<sup>6</sup> revolutions L<sub>10</sub> life, for the ISO life-calculation method.

<sup>(2)</sup>Consult your Timken engineer for instructions on use or review the Timken Engineering Manual on timken.com/catalogs.

<sup>(3)</sup>Based on 90 x 10<sup>6</sup> revolutions L<sub>10</sub> life, for The Timken Company life-calculation method. C<sub>90</sub> and C<sub>a90</sub> are radial and thrust values.

Bearing Dimensions											Geometry Factors			Bearing Weight
Width B	Width C	Eff. Ctr. a <sup>(4)</sup>	Shaft			Housing			Cage		G <sub>1</sub>	G <sub>2</sub>	C <sub>g</sub>	
			Max Shaft Fillet Radius R <sup>(5)</sup>	Backing Shoulder Dia. d <sub>a</sub>	mm in.	Max Housing Fillet Radius r <sup>(5)</sup>	Backing Shoulder Dia. D <sub>a</sub>	mm in.	A <sub>a</sub> <sup>(6)</sup>	A <sub>b</sub> <sup>(7)</sup>				
mm in.	mm in.	mm in.	mm in.	mm in.	mm in.	mm in.	mm in.	mm in.	mm in.	mm in.			kg lbs.	
46.038 1.8125	34.925 1.3750	23.4 0.92	3.3 0.13	446.0 17.56	450.0 17.72	3.3 0.13	510.0 20.08	510.0 20.08	4.1 0.16	1.2 0.05	3209.2	802.4	0.1815	21.55 47.49
50.800 2.0000	36.512 1.4375	25.9 1.02	3.3 0.13	445.0 17.52	450.0 17.72	3.3 0.13	522.0 20.55	516.0 20.31	* *	* *	3088.3	671.4	0.1850	22.81 50.26
44.450 1.7500	31.750 1.2500	26.2 1.03	3.3 0.13	452.0 17.80	456.0 17.95	3.3 0.13	531.0 20.91	531.0 20.91	5.8 0.23	4.4 0.18	3437.4	868.7	0.1880	25.07 55.25
44.450 1.7500	31.750 1.2500	26.2 1.03	3.3 0.13	452.0 17.80	456.0 17.95	3.3 0.13	531.0 20.91	537.0 21.14	5.8 0.23	4.4 0.18	3437.4	868.7	0.1880	27.83 61.34
74.612 2.9375	52.388 2.0625	50.0 1.97	3.3 0.13	453.0 17.83	457.0 17.99	3.3 0.13	549.0 21.61	537.0 21.14	11.3 0.44	-0.1 0.00	3719.4	491.5	0.2326	47.68 105.10
73.025 2.8750	50.800 2.0000	47.0 1.85	6.4 0.25	456.9 17.99	446.0 18.35	6.4 0.25	562.8 22.16	558.0 21.97	18.7 0.73	-1.5 -0.05	3353.8	551.6	0.2207	58.22 128.36
87.833 3.4580	60.325 2.3750	20.3 0.80	6.4 0.25	466.0 18.35	472.0 18.58	3.3 0.13	632.6 24.91	630.0 24.80	14.9 0.59	5.7 0.23	3621.0	321.8	0.2093	90.47 199.46
174.625 6.8750	142.875 5.6250	-36.3 -1.43	6.4 0.25	471.0 18.54	477.0 18.78	6.4 0.25	648.5 25.53	627.0 24.69	15.7 0.62	4.1 0.16	7668.4	341.3	0.2542	245.38 540.96
85.725 3.3750	62.705 2.4687	16.8 0.66	10.5 0.41	477.0 18.78	491.0 19.33	6.4 0.25	618.0 24.33	614.9 24.21	14.2 0.56	7.8 0.31	4809.1	573.4	0.2247	99.85 220.12
120.650 4.7500	95.250 3.7500	-8.1 -0.32	6.4 0.25	472.0 18.58	481.0 18.94	6.4 0.25	605.0 23.82	591.0 23.27	9.8 0.38	6.9 0.28	6865.6	481.9	0.2458	123.33 271.89
44.450 1.7500	31.750 1.2500	26.2 1.03	3.3 0.13	464.0 18.27	467.0 18.39	3.3 0.13	531.0 20.91	531.0 20.91	5.8 0.23	4.4 0.18	3437.4	868.7	0.1880	21.26 46.84
41.618 1.6385	32.545 1.2813	35.1 1.38	3.3 0.13	462.0 18.19	466.0 18.35	3.3 0.13	525.0 20.67	528.0 20.79	3.7 0.14	5.0 0.20	3159.1	928.3	0.1912	20.79 45.81
44.450 1.7500	31.750 1.2500	26.2 1.03	3.3 0.13	464.0 18.27	467.0 18.39	3.3 0.13	531.0 20.91	537.0 21.14	5.8 0.23	4.4 0.18	3437.4	868.7	0.1880	24.02 52.94
120.650 4.7500	95.250 3.7500	-8.1 -0.32	6.4 0.25	474.0 18.66	484.0 19.06	6.4 0.25	605.0 23.82	591.0 23.27	9.8 0.38	6.9 0.28	6865.6	481.9	0.2458	121.23 267.26
84.138 3.3125	60.325 2.3750	30.5 1.20	6.4 0.25	474.0 18.66	484.0 19.06	3.3 0.13	579.7 22.82	570.0 22.44	13.4 0.52	3.3 0.13	4660.5	534.5	0.2366	63.95 140.98
74.612 2.9375	57.150 2.2500	27.2 1.07	6.4 0.25	475.0 18.70	485.0 19.09	6.4 0.25	558.0 21.97	543.0 21.38	7.4 0.29	3.7 0.15	4970.4	478.5	0.2321	41.84 92.22
44.450 1.7500	31.750 1.2500	26.2 1.03	3.3 0.13	471.0 18.54	474.0 18.66	3.3 0.13	531.0 20.91	531.0 20.91	5.8 0.23	4.4 0.18	3437.4	868.7	0.1880	18.90 41.63

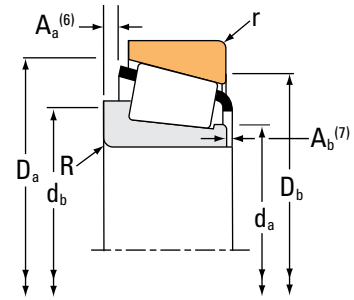
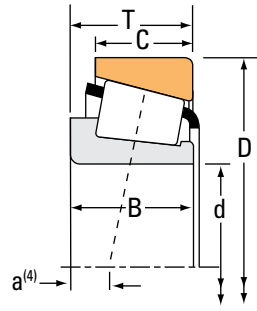
(4) Negative value indicates effective center inside cone (inner-ring) backface.  
 (5) These maximum fillet radii will be cleared by the bearing corners.  
 (6) Negative value indicates cage extends beyond cone (inner-ring) backface.  
 (7) Negative value indicates cage that does not extend beyond cone (inner-ring) front face.  
 (\*) Contact your Timken engineer for details.

Continued on next page.

# TAPERED ROLLER BEARINGS

## SINGLE-ROW • TYPE TS

### TYPE TS



Bearing Dimensions			Load Ratings							Part Number			
Bore d	O.D. D	Width T	Dynamic <sup>(1)</sup>		Factors <sup>(2)</sup>		Dynamic <sup>(3)</sup>		Factors <sup>(2)</sup>		Static C <sub>0</sub>	Inner	Outer
			C <sub>1</sub>	e	Y	C <sub>90</sub>	C <sub>a90</sub>	K	N	N			
mm in.	mm in.	mm in.	N lbf			N lbf	N lbf		N lbf				
457.200 18.0000	573.088 22.5625	74.612 2.9375	1230000 277000	0.40	1.49	319000 71700	220000 49400	1.45	3170000 713000			L570649	L570610
457.200 18.0000	596.900 23.5000	76.200 3.0000	1410000 318000	0.40	1.48	367000 82400	254000 57100	1.44	2890000 649000			EE244180	244235
457.200 18.0000	603.250 23.7500	85.725 3.3750	1490000 335000	0.45	1.32	386000 86800	300000 67300	1.29	3440000 773000			LM770949	LM770910
457.200 18.0000	615.950 24.2500	85.725 3.3750	1940000 436000	0.33	1.80	503000 113000	286000 64400	1.76	4100000 921000			LM272235	LM272210
457.200 18.0000	660.400 26.0000	91.280 3.5937	1760000 396000	0.37	1.60	457000 103000	292000 65700	1.56	3630000 816000			EE737181	737260
457.200 18.0000	660.400 26.0000	92.075 3.6250	1760000 396000	0.37	1.60	457000 103000	292000 65700	1.56	3630000 816000			EE737181X	737262
457.200 18.0000	730.148 28.7460	120.650 4.7500	2830000 635000	0.39	1.53	733000 165000	492000 111000	1.49	4870000 1100000			EE671801	672873
476.250 18.7500	565.150 22.2500	41.275 1.6250	469000 106000	0.47	1.28	122000 27400	97800 22000	1.24	1400000 315000			LL771948	LL771911
479.425 18.8750	679.450 26.7500	128.588 5.0625	3730000 839000	0.33	1.80	968000 218000	551000 124000	1.76	7400000 1660000			M272749	M272710
482.600 19.0000	615.950 24.2500	53.975 2.1250	656000 148000	0.35	1.72	170000 38200	102000 22900	1.67	1710000 384000			80480	80425
482.600 19.0000	615.950 24.2500	85.725 3.3750	1690000 380000	0.33	1.80	439000 98600	250000 56100	1.76	4100000 921000			LM272249	LM272210
482.600 19.0000	634.873 24.9950	80.963 3.1875	1470000 330000	0.34	1.75	380000 85500	223000 50200	1.70	3660000 822000			EE243190	243250
488.671 19.2390	660.400 26.0000	93.662 3.6875	2370000 533000	0.31	1.95	614000 138000	323000 72600	1.90	4590000 1030000			EE640191	640260
488.950 19.2500	634.873 24.9950	84.138 3.3125	1860000 418000	0.47	1.27	482000 108000	390000 87800	1.24	3870000 871000			LM772748	LM772710
488.950 19.2500	660.400 26.0000	93.662 3.6875	2370000 533000	0.31	1.95	614000 138000	323000 72600	1.90	4590000 1030000			EE640192	640260
489.026 19.2530	634.873 24.9950	80.963 3.1875	1470000 330000	0.34	1.75	380000 85500	223000 50200	1.70	3660000 822000			EE243192	243250
498.323 19.6190	634.873 24.9950	80.963 3.1875	1470000 330000	0.34	1.75	380000 85500	223000 50200	1.70	3660000 822000			EE243197	243250

<sup>(1)</sup>Based on 1 x 10<sup>6</sup> revolutions L<sub>10</sub> life, for the ISO life-calculation method.

<sup>(2)</sup>Consult your Timken engineer for instructions on use or review the Timken Engineering Manual on timken.com/catalogs.

<sup>(3)</sup>Based on 90 x 10<sup>6</sup> revolutions L<sub>10</sub> life, for The Timken Company life-calculation method. C<sub>90</sub> and C<sub>a90</sub> are radial and thrust values.

Bearing Dimensions											Geometry Factors			Bearing Weight
Width B	Width C	Eff. Ctr. a <sup>(4)</sup>	Shaft			Housing			Cage		G <sub>1</sub>	G <sub>2</sub>	C <sub>g</sub>	
			Max Shaft Fillet Radius R <sup>(5)</sup>	Backing Shoulder Dia. d <sub>a</sub>	Backing Shoulder Dia. d <sub>b</sub>	Max Housing Fillet Radius r <sup>(5)</sup>	Backing Shoulder Dia. D <sub>a</sub>	Backing Shoulder Dia. D <sub>b</sub>	A <sub>a</sub> <sup>(6)</sup>	A <sub>b</sub> <sup>(7)</sup>				
mm in.	mm in.	mm in.	mm in.	mm in.	mm in.	mm in.	mm in.	mm in.	mm in.	mm in.				kg lbs.
74.612 2.9375	57.150 2.2500	27.2 1.07	6.4 0.25	475.0 18.70	485.0 19.09	6.4 0.25	558.0 21.97	543.0 21.38	7.4 0.29	3.7 0.15	4970.4	478.5	0.2321	41.77 92.07
73.025 2.8750	53.975 2.1250	26.7 1.05	9.7 0.38	478.0 18.82	494.0 19.45	3.3 0.13	570.0 22.47	567.0 22.32	13.8 0.54	4.0 0.16	4411.8	627.1	0.2233	49.51 109.12
84.138 3.3125	60.325 2.3750	30.5 1.20	6.4 0.25	479.0 18.86	489.0 19.25	3.3 0.13	579.7 22.82	570.0 22.44	13.4 0.52	3.3 0.13	4660.5	534.5	0.2366	59.95 132.16
85.725 3.3750	66.675 2.6250	12.4 0.49	6.4 0.25	483.0 19.02	493.0 19.41	6.4 0.25	597.0 23.48	585.0 23.03	8.0 0.31	4.0 0.16	6037.2	665.8	0.2333	71.13 156.81
85.725 3.3750	62.705 2.4687	16.8 0.66	10.5 0.41	489.0 19.25	503.9 19.84	6.4 0.25	618.0 24.33	614.9 24.21	14.2 0.56	7.8 0.31	4809.1	573.4	0.2247	92.32 203.51
91.262 3.5930	63.500 2.5000	16.8 0.66	6.4 0.25	489.0 19.25	495.0 19.49	6.4 0.25	618.2 24.34	614.9 24.21	14.2 0.56	2.3 0.09	4809.1	573.4	0.2247	95.10 209.66
114.300 4.5000	82.550 3.2500	5.3 0.21	9.7 0.38	491.0 19.33	507.0 19.96	6.4 0.25	681.0 26.79	675.0 26.57	19.8 0.78	10.2 0.41	4968.3	343.4	0.2315	175.01 385.83
41.275 1.6250	31.750 1.2500	58.4 2.30	3.3 0.13	491.0 19.33	495.0 19.49	3.3 0.13	549.0 21.61	543.0 21.38	3.5 0.13	1.4 0.06	3792.4	1237.1	0.2189	18.78 41.40
128.588 5.0625	101.600 4.0000	-8.9 -0.35	6.4 0.25	507.0 19.96	516.0 20.31	6.4 0.25	648.0 25.52	633.0 24.92	9.9 0.39	7.7 0.30	8110.8	508.6	0.2598	149.07 328.63
46.038 1.8125	41.275 1.6250	36.6 1.44	3.3 0.13	501.0 19.72	504.0 19.84	3.3 0.13	579.0 22.80	582.0 22.91	6.2 0.24	3.0 0.12	4148.9	1071.4	0.2056	34.60 76.26
85.725 3.3750	66.675 2.6250	12.4 0.49	6.4 0.25	501.0 19.72	513.0 20.20	6.4 0.25	597.0 23.48	585.0 23.03	8.0 0.31	4.0 0.16	6037.2	665.8	0.2333	58.37 128.68
80.962 3.1875	63.500 2.5000	19.1 0.75	6.4 0.25	510.0 20.08	516.0 20.31	3.3 0.13	609.0 24.00	603.0 23.74	8.1 0.31	2.5 0.10	6057.3	726.6	0.2350	66.20 145.96
94.458 3.7188	69.850 2.7500	4.8 0.19	6.4 0.25	513.0 20.20	522.0 20.55	6.4 0.25	630.5 24.82	624.0 24.57	10.5 0.41	4.6 0.18	6322.4	601.7	0.2310	88.16 194.34
84.138 3.3125	61.912 2.4375	40.9 1.61	6.4 0.25	510.0 20.08	522.0 20.55	3.3 0.13	613.3 24.15	600.0 23.62	10.2 0.40	3.0 0.12	5447.5	602.2	0.2525	64.23 141.61
94.458 3.7188	69.850 2.7500	4.8 0.19	6.4 0.25	513.0 20.20	522.0 20.55	6.4 0.25	630.5 24.82	624.0 24.57	10.5 0.41	4.6 0.18	6322.4	601.7	0.2310	88.01 193.99
80.962 3.1875	63.500 2.5000	19.1 0.75	6.4 0.25	516.0 20.31	522.0 20.55	3.3 0.13	609.0 24.00	603.0 23.74	8.1 0.31	2.5 0.10	6057.3	726.6	0.2350	62.88 138.62
80.962 3.1875	63.500 2.5000	19.1 0.75	6.4 0.25	522.0 20.55	528.0 20.79	3.3 0.13	609.0 24.00	603.0 23.74	8.1 0.31	2.5 0.10	6057.3	726.6	0.2350	58.31 128.55

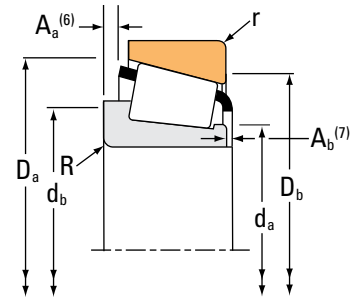
<sup>(4)</sup>Negative value indicates effective center inside cone (inner-ring) backface.  
<sup>(5)</sup>These maximum fillet radii will be cleared by the bearing corners.  
<sup>(6)</sup>Negative value indicates cage extends beyond cone (inner-ring) backface.  
<sup>(7)</sup>Negative value indicates cage that does not extend beyond cone (inner-ring) front face.

Continued on next page.

# TAPERED ROLLER BEARINGS

## SINGLE-ROW • TYPE TS

### TYPE TS



Bearing Dimensions			Load Ratings							Part Number		
Bore d	O.D. D	Width T	Dynamic <sup>(1)</sup>		Factors <sup>(2)</sup>		Dynamic <sup>(3)</sup>		Factors <sup>(2)</sup>	Static	Inner	Outer
			C <sub>1</sub>	e	Y	C <sub>90</sub>	C <sub>a90</sub>	K	C <sub>0</sub>			
mm in.	mm in.	mm in.	N lbf			N lbf	N lbf			N lbf		
498.475 19.6250	634.873 24.9950	80.963 3.1875	1470000 330000	0.34	1.75	380000 85500	223000 50200	1.70		3660000 822000	EE243196	243250
500.000 19.6850	640.000 25.1969	80.000 3.1496	1710000 384000	0.35	1.73	443000 99500	262000 59000	1.69		3750000 844000	NP267201	NP876612
501.650 19.7500	596.900 23.5000	53.975 2.1250	695000 156000	0.35	1.72	180000 40500	108000 24200	1.67		1710000 384000	80487	80418
501.650 19.7500	711.200 28.0000	136.525 5.3750	3530000 794000	0.33	1.80	916000 206000	521000 117000	1.76		8070000 1820000	M274149	M274110
508.000 20.0000	736.600 29.0000	88.900 3.5000	1990000 447000	0.47	1.27	516000 116000	418000 94000	1.23		3430000 772000	EE982003	982900
508.000 20.0000	838.200 33.0000	146.050 5.7500	3610000 812000	0.48	1.25	936000 210000	769000 173000	1.22		6530000 1470000	EE426200	426330
514.350 20.2500	736.600 29.0000	88.900 3.5000	1990000 447000	0.47	1.27	516000 116000	418000 94000	1.23		3430000 772000	EE982028	982900
520.700 20.5000	736.600 29.0000	88.900 3.5000	1990000 447000	0.47	1.27	516000 116000	418000 94000	1.23		3430000 772000	EE982051	982900
533.400 21.0000	635.000 25.0000	50.800 2.0000	892000 201000	0.41	1.48	231000 52000	161000 36100	1.44		2040000 459000	LL575343	LL575310
533.400 21.0000	784.225 30.8750	88.900 3.5000	2170000 487000	0.48	1.26	561000 126000	457000 103000	1.23		3880000 873000	EE522102	523087
536.575 21.1250	761.873 29.9950	146.050 5.7500	4010000 902000	0.33	1.80	1040000 234000	592000 133000	1.76		9250000 2080000	M276449	M276410
536.575 21.1250	780.000 30.7087	150.000 5.9055	4010000 902000	0.33	1.80	1040000 234000	592000 133000	1.76		9250000 2080000	NP266377	NP543910
539.750 21.2500	635.000 25.0000	50.800 2.0000	892000 201000	0.41	1.48	231000 52000	161000 36100	1.44		2040000 459000	LL575349	LL575310
546.100 21.5000	736.600 29.0000	76.200 3.0000	1400000 315000	0.51	1.18	363000 81600	316000 71000	1.15		3240000 728000	EE542215	542290
549.097 21.6180	692.150 27.2500	80.962 3.1875	1520000 342000	0.38	1.59	394000 88500	254000 57000	1.55		3970000 892000	L476548	L476510
549.275 21.6250	692.150 27.2500	80.962 3.1875	1520000 342000	0.38	1.59	394000 88500	254000 57000	1.55		3970000 892000	L476549	L476510
558.800 22.0000	723.900 28.5000	73.025 2.8750	1540000 345000	0.49	1.21	398000 89500	337000 75700	1.18		3440000 773000	EE647220	647285

<sup>(1)</sup>Based on 1 x 10<sup>6</sup> revolutions L<sub>10</sub> life, for the ISO life-calculation method.

<sup>(2)</sup>Consult your Timken engineer for instructions on use or review the Timken Engineering Manual on timken.com/catalogs.

<sup>(3)</sup>Based on 90 x 10<sup>6</sup> revolutions L<sub>10</sub> life, for The Timken Company life-calculation method. C<sub>90</sub> and C<sub>a90</sub> are radial and thrust values.

Bearing Dimensions											Geometry Factors			Bearing Weight
Width B	Width C	Eff. Ctr. a <sup>(4)</sup>	Shaft			Housing			Cage		G <sub>1</sub>	G <sub>2</sub>	C <sub>g</sub>	
			Max Shaft Fillet Radius R <sup>(5)</sup>	Backing Shoulder Dia. d <sub>a</sub>	Backing Shoulder Dia. d <sub>b</sub>	Max Housing Fillet Radius r <sup>(5)</sup>	Backing Shoulder Dia. D <sub>a</sub>	Backing Shoulder Dia. D <sub>b</sub>	A <sub>a</sub> <sup>(6)</sup>	A <sub>b</sub> <sup>(7)</sup>				
mm in.	mm in.	mm in.	mm in.	mm in.	mm in.	mm in.	mm in.	mm in.	mm in.	mm in.				kg lbs.
80.962 3.1875	63.500 2.5000	19.1 0.75	6.4 0.25	522.0 20.55	528.0 20.79	3.3 0.13	609.0 24.00	603.0 23.74	8.1 0.31	2.5 0.10	6057.3	726.6	0.2350	58.44 128.85
80.000 3.1496	63.500 2.5000	21.3 0.84	6.4 0.25	522.0 20.55	534.0 21.02	3.3 0.13	616.0 24.25	611.9 24.09	7.2 0.28	2.7 0.11	6257.5	879.0	0.2384	61.55 135.68
46.038 1.8125	41.275 1.6250	36.6 1.44	3.3 0.13	516.0 20.31	519.0 20.43	3.3 0.13	579.0 22.80	576.0 22.68	6.2 0.24	3.0 0.12	4148.9	1071.4	0.2056	23.50 51.79
136.525 5.3750	106.362 4.1875	-10.7 -0.42	6.4 0.25	534.0 21.02	540.0 21.26	6.4 0.25	677.9 26.69	663.0 26.10	12.2 0.48	8.6 0.34	9019.6	560.7	0.2690	170.67 376.26
81.758 3.2188	53.975 2.1250	45.5 1.79	6.4 0.25	543.0 21.38	549.0 21.61	3.3 0.13	693.0 27.28	693.0 27.28	18.5 0.72	7.7 0.31	4901.2	606.3	0.2429	107.55 237.10
139.700 5.5000	104.775 4.1250	23.9 0.94	9.7 0.38	552.0 21.73	564.0 22.20	9.7 0.38	767.7 30.23	759.0 29.88	21.5 0.84	8.3 0.33	6651.9	435.2	0.2722	290.75 640.99
81.758 3.2188	53.975 2.1250	45.5 1.79	6.4 0.25	549.0 21.61	555.0 21.85	3.3 0.13	693.0 27.28	693.0 27.28	18.5 0.72	7.7 0.31	4901.2	606.3	0.2429	104.29 229.91
81.758 3.2188	53.975 2.1250	45.5 1.79	6.4 0.25	552.0 21.73	558.0 21.97	3.3 0.13	693.0 27.28	693.0 27.28	18.5 0.72	7.7 0.31	4901.2	606.3	0.2429	100.98 222.62
50.800 2.0000	38.100 1.5000	50.8 2.00	6.4 0.25	549.0 21.61	558.0 21.97	6.4 0.25	621.0 24.45	612.0 24.09	4.5 0.18	2.8 0.11	4808.4	1201.1	0.2270	27.24 60.05
82.550 3.2500	53.975 2.1250	52.6 2.07	6.4 0.25	570.0 22.44	576.0 22.68	6.4 0.25	735.0 28.94	732.0 28.82	12.5 0.49	8.5 0.34	5013.3	457.2	0.2452	125.58 276.85
146.050 5.7500	114.300 4.5000	-9.7 -0.38	6.4 0.25	570.0 22.44	576.0 22.68	6.4 0.25	725.6 28.57	711.0 27.99	13.3 0.52	5.5 0.22	10625.0	614.5	0.2839	211.00 465.18
150.000 5.9055	114.300 4.5000	-13.7 -0.54	6.4 0.25	570.0 22.44	576.0 22.68	6.4 0.25	726.0 28.58	720.0 28.35	18.4 0.72	4.5 0.18	10625.0	614.5	0.2839	234.26 516.46
50.800 2.0000	38.100 1.5000	50.8 2.00	6.4 0.25	555.0 21.85	564.0 22.20	6.4 0.25	621.0 24.45	612.0 24.09	4.5 0.18	2.8 0.11	4808.4	1201.1	0.2270	25.10 55.34
76.200 3.0000	50.800 2.0000	64.8 2.55	6.4 0.25	576.0 22.68	585.0 23.03	6.4 0.25	705.1 27.76	696.0 27.40	16.6 0.65	1.6 0.07	5727.7	782.5	0.2604	84.23 185.69
80.962 3.1875	61.912 2.4375	32.3 1.27	6.4 0.25	570.0 22.44	579.0 22.80	6.4 0.25	666.0 26.22	657.0 25.87	8.5 0.33	2.6 0.11	7261.6	889.8	0.2567	67.13 148.00
80.962 3.1875	61.912 2.4375	32.3 1.27	6.4 0.25	570.0 22.44	579.0 22.80	6.4 0.25	666.0 26.22	657.0 25.87	8.5 0.33	2.6 0.11	7261.6	889.8	0.2567	66.85 147.39
73.025 2.8750	57.150 2.2500	64.5 2.54	4.8 0.19	582.0 22.91	588.0 23.15	4.8 0.19	701.1 27.60	687.0 27.05	8.5 0.33	3.5 0.14	5594.2	804.2	0.2566	73.36 161.74

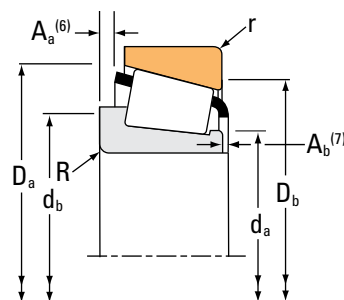
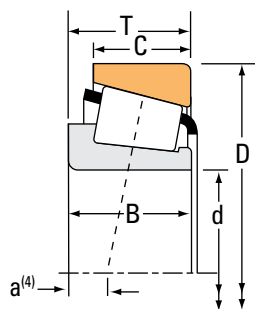
(4) Negative value indicates effective center inside cone (inner-ring) backface.  
 (5) These maximum fillet radii will be cleared by the bearing corners.  
 (6) Negative value indicates cage extends beyond cone (inner-ring) backface.  
 (7) Negative value indicates cage that does not extend beyond cone (inner-ring) front face.

Continued on next page.

# TAPERED ROLLER BEARINGS

## SINGLE-ROW • TYPE TS

### TYPE TS



Bearing Dimensions			Load Ratings							Part Number		
Bore d	O.D. D	Width T	Dynamic <sup>(1)</sup>		Factors <sup>(2)</sup>		Dynamic <sup>(3)</sup>		Factors <sup>(2)</sup>	Static	Inner	Outer
			C <sub>1</sub>	e	Y	C <sub>90</sub>	C <sub>a90</sub>	K	C <sub>0</sub>			
mm in.	mm in.	mm in.	N lbf			N lbf	N lbf			N lbf		
558.800 22.0000	736.600 29.0000	76.200 3.0000	1400000 315000	0.51	1.18	363000 81600	316000 71000	1.15		3240000 728000	EE542220	542290
558.800 22.0000	736.600 29.0000	88.108 3.4688	2070000 465000	0.34	1.75	536000 121000	315000 70700	1.70		4580000 1030000	EE843220	843290
558.800 22.0000	736.600 29.0000	104.775 4.1250	2570000 578000	0.35	1.73	667000 150000	395000 88800	1.69		6370000 1430000	LM377449	LM377410
558.800 22.0000	901.573 35.4950	134.938 5.3125	3790000 853000	0.41	1.47	984000 221000	687000 154000	1.43		6760000 1520000	EE327220	327355
571.500 22.5000	812.800 32.0000	155.575 6.1250	4530000 1020000	0.33	1.80	1180000 264000	669000 150000	1.76		10600000 2370000	M278749	M278710
571.500 22.5000	812.800 32.0000	160.350 6.3130	4530000 1020000	0.33	1.80	1180000 264000	669000 150000	1.76		10600000 2370000	NP794398	NP384818
584.200 23.0000	685.800 27.0000	49.212 1.9375	798000 179000	0.44	1.37	207000 46500	155000 34800	1.34		2280000 513000	LL778149	LL778110
584.200 23.0000	709.612 27.9375	58.738 2.3125	1210000 271000	0.48	1.26	313000 70300	254000 57200	1.23		2930000 659000	L778149	L778110
584.200 23.0000	901.700 35.5000	150.020 5.9063	4980000 1120000	0.33	1.81	1290000 290000	732000 165000	1.76		7590000 1710000	EE662303	663550
596.900 23.5000	685.800 27.0000	31.750 1.2500	344000 77300	0.53	1.14	89200 20000	80400 18100	1.11		963000 217000	680235	680270
602.945 23.7380	787.400 31.0000	93.662 3.6875	2610000 587000	0.37	1.62	677000 152000	430000 96600	1.58		5620000 1260000	EE649237	649310
607.720 23.9260	787.400 31.0000	93.662 3.6875	2610000 587000	0.37	1.62	677000 152000	430000 96600	1.58		5620000 1260000	EE649239	649310
609.346 23.9900	787.400 31.0000	93.662 3.6875	2610000 587000	0.37	1.62	677000 152000	430000 96600	1.58		5620000 1260000	EE649238	649310
609.397 23.9920	762.000 30.0000	95.250 3.7500	1980000 445000	0.49	1.23	513000 115000	428000 96300	1.20		5470000 1230000	L879946	L879910
609.600 24.0000	762.000 30.0000	95.250 3.7500	1980000 445000	0.49	1.23	513000 115000	428000 96300	1.20		5470000 1230000	L879947	L879910
609.600 24.0000	774.700 30.5000	85.725 3.3750	2020000 453000	0.40	1.49	523000 118000	360000 80900	1.45		4620000 1040000	L580049	L580010
609.600 24.0000	787.400 31.0000	93.662 3.6875	2610000 587000	0.37	1.62	677000 152000	430000 96600	1.58		5620000 1260000	EE649240	649310

<sup>(1)</sup>Based on 1 x 10<sup>6</sup> revolutions L<sub>10</sub> life, for the ISO life-calculation method.

<sup>(2)</sup>Consult your Timken engineer for instructions on use or review the Timken Engineering Manual on timken.com/catalogs.

<sup>(3)</sup>Based on 90 x 10<sup>6</sup> revolutions L<sub>10</sub> life, for The Timken Company life-calculation method. C<sub>90</sub> and C<sub>a90</sub> are radial and thrust values.



Bearing Dimensions											Geometry Factors			Bearing Weight
Width B	Width C	Eff. Ctr. a <sup>(4)</sup>	Shaft			Housing			Cage		G <sub>1</sub>	G <sub>2</sub>	C <sub>g</sub>	
			Max Shaft Fillet Radius R <sup>(5)</sup>	Backing Shoulder Dia. d <sub>a</sub>	Shoulder Dia. d <sub>b</sub>	Max Housing Fillet Radius r <sup>(5)</sup>	Backing Shoulder Dia. D <sub>a</sub>	Shoulder Dia. D <sub>b</sub>	A <sub>a</sub> <sup>(6)</sup>	A <sub>b</sub> <sup>(7)</sup>				
mm in.	mm in.	mm in.	mm in.	mm in.	mm in.	mm in.	mm in.	mm in.	mm in.	mm in.				kg lbs.
76.200 3.0000	50.800 2.0000	64.8 2.55	6.4 0.25	585.0 23.03	594.0 23.39	6.4 0.25	705.1 27.76	696.0 27.40	16.6 0.65	1.6 0.07	5727.7	782.5	0.2604	77.61 171.10
88.108 3.4688	63.500 2.5000	22.6 0.89	6.4 0.25	585.0 23.03	591.0 23.27	6.4 0.25	707.1 27.84	699.0 27.52	10.6 0.42	4.1 0.16	7097.5	714.8	0.2478	94.77 208.94
104.775 4.1250	80.962 3.1875	15.7 0.62	6.4 0.25	585.0 23.03	594.0 23.39	6.4 0.25	708.0 27.87	696.0 27.40	8.9 0.35	5.6 0.22	9314.8	907.6	0.2735	118.57 261.39
129.380 5.0937	101.600 4.0000	16.8 0.66	12.7 0.50	606.0 23.86	624.0 24.57	6.4 0.25	840.0 33.07	831.0 32.72	29.4 1.16	6.1 0.24	7790.8	478.4	0.2715	311.89 687.90
155.575 6.1250	120.650 4.7500	-11.4 -0.45	6.4 0.25	609.0 23.98	615.0 24.21	6.4 0.25	774.0 30.46	756.0 29.76	15.0 0.59	5.9 0.23	12425.1	669.4	0.2990	255.86 564.08
160.325 6.3120	125.425 4.9380	-12.7 -0.50	8.0 0.31	609.0 23.98	618.0 24.33	6.4 0.25	774.5 30.49	759.0 29.88	16.4 0.64	2.5 0.10	12425.1	669.4	0.2990	262.48 578.69
49.212 1.9375	34.925 1.3750	64.5 2.54	3.5 0.14	600.0 23.62	603.0 23.74	3.3 0.13	669.0 26.34	663.0 26.10	5.0 0.20	2.6 0.11	5980.0	1581.3	0.2494	29.06 64.06
57.150 2.2500	39.688 1.5625	68.8 2.71	3.5 0.14	603.0 23.74	606.0 23.86	3.3 0.13	690.6 27.19	684.0 26.93	5.7 0.22	6.2 0.25	5712.9	1057.7	0.2541	43.61 96.14
139.700 5.5000	107.950 4.2500	0.3 0.01	8.0 0.31	624.0 24.57	633.0 24.92	9.7 0.38	848.1 33.39	843.0 33.19	20.7 0.81	7.2 0.29	8756.7	477.1	0.2638	305.28 673.03
31.750 1.2500	25.400 1.0000	96.0 3.78	3.5 0.14	615.0 24.21	615.0 24.21	3.3 0.13	669.0 26.34	663.0 26.10	1.6 0.06	-0.3 -0.01	3739.1	1810.4	0.2225	16.50 36.38
93.662 3.6875	69.850 2.7500	31.5 1.24	6.4 0.25	630.0 24.80	639.0 25.16	6.4 0.25	755.3 29.74	747.0 29.41	11.1 0.43	6.2 0.25	9384.8	930.0	0.2790	116.23 256.19
93.662 3.6875	69.850 2.7500	31.5 1.24	6.4 0.25	633.0 24.92	642.0 25.28	6.4 0.25	755.3 29.74	747.0 29.41	11.1 0.43	6.2 0.25	9384.8	930.0	0.2790	112.90 248.85
93.662 3.6875	69.850 2.7500	31.5 1.24	6.4 0.25	633.0 24.92	642.0 25.28	6.4 0.25	755.3 29.74	747.0 29.41	11.1 0.43	6.2 0.25	9384.8	930.0	0.2790	111.76 246.34
92.075 3.6250	71.438 2.8125	57.9 2.28	6.4 0.25	633.0 24.92	642.0 25.28	6.4 0.25	741.0 29.17	720.0 28.35	11.7 0.46	5.1 0.20	9578.8	1006.3	0.3063	93.40 205.91
92.075 3.6250	71.438 2.8125	57.9 2.28	6.4 0.25	633.0 24.92	642.0 25.28	6.4 0.25	741.0 29.17	720.0 28.35	11.7 0.46	5.1 0.20	9578.8	1006.3	0.3063	93.26 205.60
79.375 3.1250	60.325 2.3750	45.2 1.78	6.4 0.25	633.0 24.92	642.0 25.28	6.4 0.25	749.5 29.51	741.0 29.17	-8.9 -0.35	3.9 0.15	7661.4	933.9	0.2671	86.98 191.74
93.662 3.6875	69.850 2.7500	31.5 1.24	6.4 0.25	633.0 24.92	642.0 25.28	6.4 0.25	755.3 29.74	747.0 29.41	11.1 0.43	6.2 0.25	9384.8	930.0	0.2790	111.58 245.95

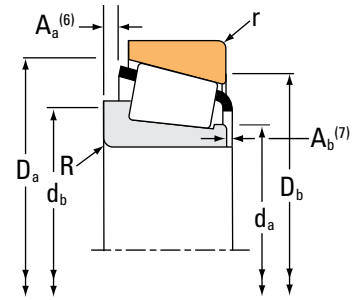
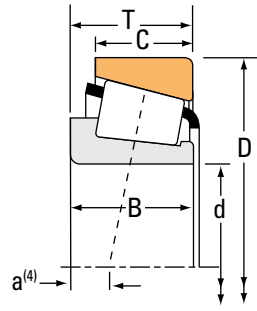
<sup>(4)</sup>Negative value indicates effective center inside cone (inner-ring) backface.  
<sup>(5)</sup>These maximum fillet radii will be cleared by the bearing corners.  
<sup>(6)</sup>Negative value indicates cage extends beyond cone (inner-ring) backface.  
<sup>(7)</sup>Negative value indicates cage that does not extend beyond cone (inner-ring) front face.

Continued on next page.

# TAPERED ROLLER BEARINGS

## SINGLE-ROW • TYPE TS

### TYPE TS



Bearing Dimensions			Load Ratings							Part Number			
Bore d	O.D. D	Width T	Dynamic <sup>(1)</sup>		Factors <sup>(2)</sup>		Dynamic <sup>(3)</sup>		Factors <sup>(2)</sup>		Static C <sub>0</sub>	Inner	Outer
			C <sub>1</sub>	e	Y	C <sub>90</sub>	C <sub>a90</sub>	K	N	N			
mm in.	mm in.	mm in.	N lbf			N lbf	N lbf		N lbf				
609.600 24.0000	787.400 31.0000	93.662 3.6875	2540000 570000	0.37	1.62	657000 148000	417000 93800	1.58	5390000 1210000		EE649240H	649310	
609.600 24.0000	812.800 32.0000	82.550 3.2500	2080000 467000	0.33	1.82	538000 121000	303000 68200	1.77	4060000 912000		EE743240	743320	
615.950 24.2500	708.025 27.8750	41.275 1.6250	605000 136000	0.39	1.55	157000 35200	104000 23400	1.51	1840000 414000		LL580049	LL580010	
630.000 24.8031	850.000 33.4646	108.000 4.2520	2890000 649000	0.40	1.51	748000 168000	510000 115000	1.47	5910000 1330000		JL580946	JL580914	
635.000 25.0000	736.600 29.0000	57.150 2.2500	654000 147000	0.44	1.37	169000 38100	127000 28600	1.33	1830000 412000		80780	80720	
635.000 25.0000	933.450 36.7500	179.388 7.0625	5860000 1320000	0.33	1.80	1520000 342000	865000 195000	1.76	13900000 3120000		M281635	M281610	
646.112 25.4375	857.250 33.7500	141.288 5.5625	4700000 1060000	0.33	1.80	1220000 274000	694000 156000	1.76	10400000 2330000		LM281049	LM281010	
660.235 25.9935	812.800 32.0000	95.250 3.7500	2530000 570000	0.33	1.80	657000 148000	374000 84100	1.76	5940000 1340000		L281146	L281110	
660.400 26.0000	812.800 32.0000	92.250 3.7500	2530000 570000	0.33	1.80	657000 148000	374000 84100	1.76	5940000 1340000		L281148	L281110	
660.400 26.0000	812.800 32.0000	95.250 3.7500	2730000 615000	0.33	1.80	709000 159000	404000 90700	1.76	6620000 1490000		L281147	L281110	
660.400 26.0000	854.075 33.6250	85.725 3.3750	2240000 504000	0.35	1.71	581000 131000	349000 78600	1.66	4620000 1040000		EE749260	749336	
660.400 26.0000	854.923 33.6584	85.113 3.3509	2240000 504000	0.35	1.71	581000 131000	349000 78600	1.66	4620000 1040000		EE749260	749334	
660.400 26.0000	939.800 37.0000	136.525 5.3750	3560000 800000	0.41	1.48	923000 207000	642000 144000	1.44	7800000 1750000		EE538261	538370	
660.400 26.0000	939.800 37.0000	136.525 5.3750	3560000 800000	0.41	1.48	923000 207000	642000 144000	1.44	7800000 1750000		EE538260	538370	
673.100 26.5000	793.750 31.2500	66.675 2.6250	1110000 249000	0.36	1.67	287000 64600	177000 39800	1.62	3140000 707000		LL481448	LL481411	
673.100 26.5000	922.731 36.3280	133.350 5.2500	5540000 1250000	0.28	2.12	1440000 323000	695000 156000	2.07	10700000 2410000		NP813945	NP216163	
679.450 26.7500	901.700 35.5000	142.875 5.6250	5020000 1130000	0.33	1.80	1300000 292000	741000 166000	1.76	11000000 2480000		LM281849	LM281810	

<sup>(1)</sup>Based on 1 x 10<sup>6</sup> revolutions L<sub>10</sub> life, for the ISO life-calculation method.

<sup>(2)</sup>Consult your Timken engineer for instructions on use or review the Timken Engineering Manual on timken.com/catalogs.

<sup>(3)</sup>Based on 90 x 10<sup>6</sup> revolutions L<sub>10</sub> life, for The Timken Company life-calculation method. C<sub>90</sub> and C<sub>a90</sub> are radial and thrust values.

Bearing Dimensions											Geometry Factors			Bearing Weight
Width B	Width C	Eff. Ctr. a <sup>(4)</sup>	Shaft			Housing			Cage		G <sub>1</sub>	G <sub>2</sub>	C <sub>g</sub>	
			Max Shaft Fillet Radius R <sup>(5)</sup>	Backing Shoulder Dia. d <sub>a</sub>	Backing Shoulder Dia. d <sub>b</sub>	Max Housing Fillet Radius r <sup>(5)</sup>	Backing Shoulder Dia. D <sub>a</sub>	Backing Shoulder Dia. D <sub>b</sub>	A <sub>a</sub> <sup>(6)</sup>	A <sub>b</sub> <sup>(7)</sup>				
mm in.	mm in.	mm in.	mm in.	mm in.	mm in.	mm in.	mm in.	mm in.	mm in.	mm in.				kg lbs.
93.662 3.6875	69.850 2.7500	31.5 1.24	6.4 0.25	633.0 24.92	642.0 25.28	6.4 0.25	755.3 29.74	747.0 29.41	13.7 0.54	5.1 0.20	9115.2	904.3	0.2761	106.87 235.60
82.550 3.2500	60.325 2.3750	29.7 1.17	6.4 0.25	636.0 25.04	645.0 25.39	6.4 0.25	768.0 30.24	768.0 30.24	10.8 0.42	4.4 0.18	7714.7	995.4	0.2499	109.52 241.45
41.275 1.6250	29.367 1.1562	61.7 2.43	3.5 0.14	630.0 24.80	633.0 24.92	3.3 0.13	690.0 27.17	687.0 27.05	3.1 0.12	2.8 0.11	6265.9	2025.9	0.2418	23.09 50.92
100.000 3.9370	78.000 3.0709	35.6 1.40	7.5 0.30	660.0 25.98	672.0 26.46	6.0 0.24	804.0 31.65	801.0 31.54	16.1 0.63	11.7 0.46	9816.1	894.2	0.2896	158.02 348.38
53.975 2.1250	41.275 1.6250	69.3 2.73	3.3 0.13	651.0 25.63	654.0 25.75	3.3 0.13	717.8 28.26	714.0 28.11	9.2 0.36	0.2 0.01	5883.6	1625.0	0.2465	33.83 74.57
177.800 7.0000	141.288 5.5625	-13.5 -0.53	12.0 0.47	687.0 27.05	699.0 27.52	6.4 0.25	889.5 35.02	870.0 34.25	17.9 0.70	9.7 0.38	17304.9	775.6	0.3335	418.43 922.49
141.288 5.5625	109.538 4.3125	3.0 0.12	6.4 0.25	678.0 26.69	684.0 26.93	6.4 0.25	824.5 32.46	810.0 31.89	13.3 0.52	7.5 0.30	14763.0	920.6	0.3153	219.31 483.50
95.250 3.7500	73.025 2.8750	27.9 1.10	6.4 0.25	681.0 26.81	693.0 27.28	6.4 0.25	789.0 31.04	777.0 30.59	8.9 0.35	4.5 0.18	11705.7	915.8	0.2888	99.84 220.13
95.250 3.7500	73.025 2.8750	27.9 1.10	6.4 0.25	681.0 26.81	693.0 27.28	6.4 0.25	789.0 31.04	777.0 30.59	8.9 0.35	5.3 0.21	11705.7	915.8	0.2888	99.94 220.33
95.250 3.7500	73.025 2.8750	27.9 1.10	6.4 0.25	681.0 26.81	693.0 27.28	6.4 0.25	789.0 31.04	777.0 30.59	8.7 0.34	5.1 0.20	12635.6	984.9	0.2968	103.68 228.59
85.468 3.3649	60.325 2.3750	39.4 1.55	9.7 0.38	687.0 27.05	702.0 27.64	6.4 0.25	813.0 32.01	813.0 32.01	11.6 0.45	2.4 0.10	9222.1	1151.5	0.2707	114.24 251.84
85.468 3.3649	59.898 2.3582	39.4 1.55	9.7 0.38	687.0 27.05	702.0 27.64	9.7 0.38	813.0 32.01	807.0 31.77	11.6 0.45	2.4 0.10	9222.1	1151.5	0.2707	113.89 251.05
127.000 5.0000	98.425 3.8750	30.7 1.21	6.4 0.25	696.0 27.40	708.0 27.87	6.4 0.25	883.9 34.80	876.0 34.49	22.0 0.86	8.3 0.33	11455.4	802.1	0.3078	275.36 607.05
127.000 5.0000	98.425 3.8750	30.7 1.21	6.4 0.25	696.0 27.40	708.0 27.87	6.4 0.25	883.9 34.80	876.0 34.49	22.0 0.86	8.3 0.33	11455.4	802.1	0.3078	275.36 607.05
61.912 2.4375	49.212 1.9375	53.8 2.12	6.4 0.25	690.0 27.17	702.0 27.64	6.4 0.25	771.0 30.35	765.0 30.12	4.0 0.16	1.6 0.07	8762.7	1649.9	0.2659	51.80 114.21
135.103 5.3190	110.061 4.3331	3.6 0.14	25.4 1.00	711.0 27.99	756.0 29.76	6.4 0.25	891.0 35.08	876.0 34.49	3.1 0.12	8.2 0.33	15064.3	922.1	0.3002	267.37 589.46
142.875 5.6250	111.125 4.3750	6.9 0.27	9.7 0.38	714.0 28.11	726.0 28.58	6.4 0.25	866.6 34.12	852.0 33.54	12.8 0.50	7.4 0.30	16257.4	961.7	0.3252	246.25 542.86

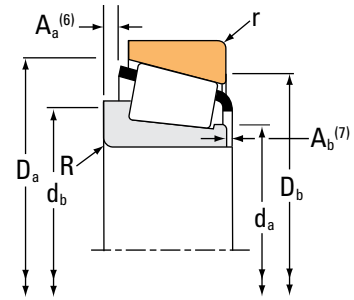
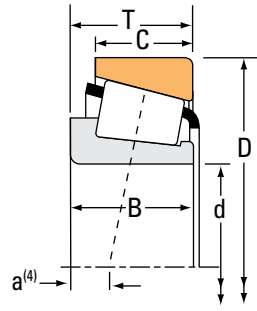
<sup>(4)</sup>Negative value indicates effective center inside cone (inner-ring) backface.  
<sup>(5)</sup>These maximum fillet radii will be cleared by the bearing corners.  
<sup>(6)</sup>Negative value indicates cage extends beyond cone (inner-ring) backface.  
<sup>(7)</sup>Negative value indicates cage that does not extend beyond cone (inner-ring) front face.

Continued on next page.

# TAPERED ROLLER BEARINGS

## SINGLE-ROW • TYPE TS

### TYPE TS



Bearing Dimensions			Load Ratings							Part Number			
Bore d	O.D. D	Width T	Dynamic <sup>(1)</sup>		Factors <sup>(2)</sup>		Dynamic <sup>(3)</sup>		Factors <sup>(2)</sup>		Static C <sub>0</sub>	Inner	Outer
			C <sub>1</sub>	e	Y	C <sub>90</sub>	C <sub>a90</sub>	K	N	N			
mm in.	mm in.	mm in.	N lbf			N lbf	N lbf		N lbf				
682.625 26.8750	965.200 38.0000	185.737 7.3125	6240000 1400000	0.33	1.80	1620000 364000	921000 207000	1.76	1490000 3340000			M282249	M282210
685.800 27.0000	876.300 34.5000	93.662 3.6875	2750000 619000	0.42	1.44	714000 160000	508000 114000	1.40	630000 1420000			EE655270	655345
698.500 27.5000	819.150 32.2500	63.500 2.5000	1050000 237000	0.35	1.72	273000 61500	164000 36800	1.67	3190000 716000			LL382149	LL382110
711.200 28.0000	914.400 36.0000	85.725 3.3750	2390000 536000	0.38	1.58	619000 139000	403000 90600	1.54	5190000 1170000			EE755280	755360
723.900 28.5000	914.400 36.0000	84.138 3.3125	2390000 536000	0.38	1.58	619000 139000	403000 90600	1.54	5190000 1170000			EE755285	755360
736.600 29.0000	825.500 32.5000	31.750 1.2500	424000 95300	0.40	1.51	110000 24700	74800 16800	1.47	1300000 291000			LL582949	LL582910
749.300 29.5000	965.200 38.0000	93.662 3.6875	2450000 552000	0.40	1.49	636000 143000	438000 98400	1.45	5510000 1240000			EE752295	752380
749.300 29.5000	990.600 39.0000	159.500 6.2795	5980000 1340000	0.33	1.80	1550000 349000	883000 198000	1.76	13500000 3050000			LM283649	LM283610
749.300 29.5000	990.600 39.0000	159.500 6.2795	5130000 1150000	0.33	1.80	1330000 299000	757000 170000	1.76	13200000 2980000			LM283649H	LM283610
759.925 29.9183	889.000 35.0000	69.850 2.7500	1570000 352000	0.38	1.58	406000 91400	263000 59200	1.54	4270000 960000			LL483448	LL483418
759.925 29.9183	889.000 35.0000	88.900 3.5000	2350000 529000	0.31	1.97	610000 137000	319000 71700	1.91	6230000 1400000			L183448	L183410
762.000 30.0000	889.000 35.0000	63.500 2.5000	1080000 243000	0.38	1.58	280000 62900	182000 40800	1.54	3390000 762000			EE175301	175350
762.000 30.0000	889.000 35.0000	69.850 2.7500	1080000 243000	0.38	1.58	280000 62900	182000 40800	1.54	3390000 762000			EE175300	175350
762.000 30.0000	889.000 35.0000	69.850 2.7500	1570000 352000	0.38	1.58	406000 91400	263000 59200	1.54	4270000 960000			LL483449	LL483418
762.000 30.0000	889.000 35.0000	88.900 3.5000	2350000 529000	0.31	1.97	610000 137000	319000 71700	1.91	6230000 1400000			L183449	L183410
762.000 30.0000	965.200 38.0000	93.662 3.6875	2450000 552000	0.40	1.49	636000 143000	438000 98400	1.45	5510000 1240000			EE752300	752380
774.700 30.5000	965.200 38.0000	93.662 3.6875	2450000 552000	0.40	1.49	636000 143000	438000 98400	1.45	5510000 1240000			EE752305	752380

<sup>(1)</sup>Based on 1 x 10<sup>6</sup> revolutions L<sub>10</sub> life, for the ISO life-calculation method.

<sup>(2)</sup>Consult your Timken engineer for instructions on use or review the Timken Engineering Manual on timken.com/catalogs.

<sup>(3)</sup>Based on 90 x 10<sup>6</sup> revolutions L<sub>10</sub> life, for The Timken Company life-calculation method. C<sub>90</sub> and C<sub>a90</sub> are radial and thrust values.

Bearing Dimensions											Geometry Factors			Bearing Weight
Width B	Width C	Eff. Ctr. a <sup>(4)</sup>	Shaft			Housing			Cage		G <sub>1</sub>	G <sub>2</sub>	C <sub>g</sub>	
			Max Shaft Fillet Radius R <sup>(5)</sup>	Backing Shoulder Dia. d <sub>a</sub> d <sub>b</sub>		Max Housing Fillet Radius r <sup>(5)</sup>	Backing Shoulder Dia. D <sub>a</sub> D <sub>b</sub>		A <sub>a</sub> <sup>(6)</sup>	A <sub>b</sub> <sup>(7)</sup>				
mm in.	mm in.	mm in.	mm in.	mm in.	mm in.	mm in.	mm in.	mm in.	mm in.	mm in.				kg lbs.
185.738 7.3125	142.875 5.6250	-15.2 -0.60	9.7 0.38	723.0 28.46	738.0 29.06	6.4 0.25	919.8 36.21	900.0 35.43	19.2 0.75	10.5 0.42	18773.0	843.1	0.3426	426.04 939.28
92.075 3.6250	69.850 2.7500	54.1 2.13	6.4 0.25	714.0 28.11	723.0 28.46	6.4 0.25	841.4 33.13	831.0 32.72	10.4 0.41	5.9 0.23	11844.1	1202.6	0.3119	134.15 295.74
63.500 2.5000	50.800 2.0000	54.6 2.15	3.3 0.13	717.0 28.23	720.0 28.35	3.3 0.13	795.6 31.32	792.0 31.18	7.2 0.28	-1.8 -0.07	9937.5	2090.8	0.2738	54.75 120.72
82.550 3.2500	60.325 2.3750	53.6 2.11	6.4 0.25	741.0 29.17	750.0 29.53	6.4 0.25	877.0 34.53	873.0 34.37	12.9 0.51	7.2 0.29	11122.5	1282.2	0.2952	132.52 292.15
80.962 3.1875	60.325 2.3750	55.1 2.17	5.5 0.22	750.0 29.53	756.0 29.76	6.4 0.25	877.0 34.53	873.0 34.37	11.3 0.44	7.2 0.29	11122.5	1282.2	0.2952	122.27 269.55
31.750 1.2500	25.400 1.0000	86.9 3.42	3.5 0.14	753.1 29.65	753.1 29.65	3.3 0.13	822.0 32.36	807.0 31.77	0.3 0.01	0.1 0.01	6526.9	3683.4	0.2436	20.39 44.93
80.962 3.1875	66.675 2.6250	63.5 2.50	6.4 0.25	780.0 30.71	789.0 31.06	3.3 0.13	923.5 36.36	921.0 36.26	14.3 0.56	10.5 0.42	12456.8	1880.8	0.3116	152.15 335.45
160.338 6.3125	123.000 4.8425	6.1 0.24	6.4 0.25	786.0 30.94	792.0 31.18	6.4 0.25	952.4 37.50	936.0 36.85	15.0 0.59	6.2 0.25	20904.8	1142.9	0.3534	329.67 726.81
160.338 6.3125	123.000 4.8425	6.1 0.24	6.4 0.25	786.0 30.94	792.0 31.18	6.4 0.25	952.4 37.50	936.0 36.85	19.1 0.75	4.2 0.17	20571.2	1126.8	0.3514	321.90 709.67
69.850 2.7500	50.800 2.0000	62.2 2.45	3.3 0.13	777.0 30.59	783.0 30.83	3.3 0.13	858.0 33.78	855.0 33.66	7.3 0.28	4.7 0.19	12883.1	1729.9	0.3070	68.81 151.73
88.900 3.5000	72.000 2.8346	34.5 1.36	3.3 0.13	780.0 30.71	783.0 30.83	3.3 0.13	872.0 34.33	864.0 34.02	4.6 0.18	6.1 0.24	16116.5	2023.1	0.3102	89.26 196.78
63.500 2.5000	50.800 2.0000	69.6 2.74	3.3 0.13	780.0 30.71	783.0 30.83	3.3 0.13	858.3 33.79	855.0 33.66	7.6 0.30	-1.1 -0.04	11527.7	2694.6	0.2945	62.42 137.64
69.850 2.7500	50.800 2.0000	63.2 2.49	3.3 0.13	780.0 30.71	783.0 30.83	3.3 0.13	858.3 33.79	855.0 33.66	13.9 0.55	-1.1 -0.04	11527.7	2694.6	0.2945	65.86 145.22
69.850 2.7500	50.800 2.0000	62.2 2.45	3.3 0.13	780.0 30.71	783.0 30.83	3.3 0.13	858.0 33.78	855.0 33.66	7.3 0.28	4.7 0.19	12883.1	1729.9	0.3070	67.39 148.59
88.900 3.5000	72.000 2.8346	34.5 1.36	3.3 0.13	780.0 30.71	783.0 30.83	3.3 0.13	872.0 34.33	864.0 34.02	4.6 0.18	6.1 0.24	16116.5	2023.1	0.3102	87.53 192.96
80.962 3.1875	66.675 2.6250	63.5 2.50	6.4 0.25	789.0 31.06	798.0 31.42	3.3 0.13	923.5 36.36	921.0 36.26	14.3 0.56	10.5 0.42	12456.8	1880.8	0.3116	142.57 314.33
80.962 3.1875	66.675 2.6250	63.5 2.50	6.4 0.25	798.0 31.42	810.0 31.89	3.3 0.13	923.5 36.36	921.0 36.26	14.3 0.56	10.5 0.42	12456.8	1880.8	0.3116	135.30 298.27

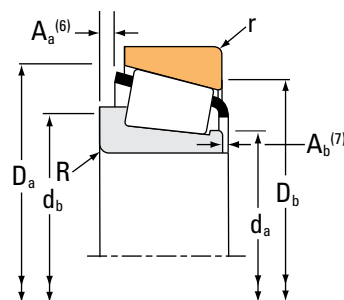
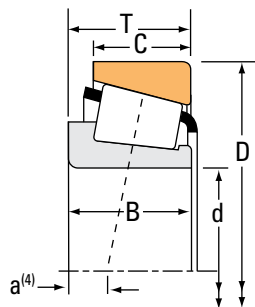
(4) Negative value indicates effective center inside cone (inner-ring) backface.  
 (5) These maximum fillet radii will be cleared by the bearing corners.  
 (6) Negative value indicates cage extends beyond cone (inner-ring) backface.  
 (7) Negative value indicates cage that does not extend beyond cone (inner-ring) front face.

Continued on next page.

# TAPERED ROLLER BEARINGS

## SINGLE-ROW • TYPE TS

### TYPE TS



Bearing Dimensions			Load Ratings							Part Number			
Bore d	O.D. D	Width T	Dynamic <sup>(1)</sup>		Factors <sup>(2)</sup>		Dynamic <sup>(3)</sup>		Factors <sup>(2)</sup>		Static C <sub>0</sub>	Inner	Outer
			C <sub>1</sub>	e	Y	C <sub>90</sub>	C <sub>a90</sub>	K	N	N			
mm in.	mm in.	mm in.	N lbf			N lbf	N lbf		N lbf				
801.688 31.5625	914.400 36.0000	58.738 2.3125	1090000 244000	0.40	1.51	281000 63300	191000 42900	1.47	3460000 778000		LL584449	LL584410	
825.500 32.5000	1041.400 41.0000	93.662 3.6875	2530000 569000	0.44	1.37	657000 148000	492000 111000	1.33	5930000 1330000		EE763325	763410	
836.612 32.9375	1041.400 41.0000	93.662 3.6875	2530000 569000	0.44	1.37	657000 148000	492000 111000	1.33	5930000 1330000		EE763329	763410	
838.200 33.0000	1041.400 41.0000	93.662 3.6875	2530000 569000	0.44	1.37	657000 148000	492000 111000	1.33	5930000 1330000		EE763330	763410	
857.250 33.7500	1092.200 43.0000	120.650 4.7500	2910000 654000	0.56	1.08	754000 169000	719000 162000	1.05	7630000 1710000		EE157337	157430	
863.600 34.0000	1130.300 44.5000	174.625 6.8750	6520000 1470000	0.33	1.80	1690000 380000	963000 216000	1.76	17400000 3920000		LM286249	LM286210	
887.000 34.9213	1123.950 44.2500	120.650 4.7500	2920000 655000	0.58	1.04	756000 170000	745000 167000	1.01	7740000 1740000		EE158349	158442	
889.000 35.0000	1123.950 44.2500	120.650 4.7500	2920000 655000	0.58	1.04	756000 170000	745000 167000	1.01	7740000 1740000		EE158350	158442	
928.000 36.5354	1060.000 41.7323	92.000 3.6220	2850000 641000	0.33	1.80	740000 166000	421000 94700	1.76	9330000 2100000		JL286948	JL286910	
928.000 36.5354	1060.000 41.7323	92.000 3.6220	2660000 599000	0.33	1.80	691000 155000	393000 88400	1.76	8460000 1900000		JL286948H	JL286910	
930.000 36.6142	1060.000 41.7323	92.000 3.6220	2850000 641000	0.33	1.80	740000 166000	421000 94700	1.76	9330000 2100000		JL286949	JL286910	
930.000 36.6142	1060.000 41.7323	92.000 3.6220	2660000 599000	0.33	1.80	691000 155000	393000 88400	1.76	8460000 1900000		JL286949H	JL286910	
946.150 37.2500	1194.435 47.0250	136.525 5.3750	6330000 1420000	0.37	1.61	1640000 369000	1050000 235000	1.57	14200000 3190000		NP957630	NP980281	
977.900 38.5000	1130.300 44.5000	66.675 2.6250	1670000 375000	0.44	1.38	433000 97300	323000 72700	1.34	5290000 1190000		LL687949	LL687910	
1016.000 40.0000	1270.000 50.0000	101.600 4.0000	2840000 640000	0.49	1.22	738000 166000	622000 140000	1.19	8030000 1800000		EE168400	168500	
1063.625 41.8750	1219.200 48.0000	65.088 2.5625	1720000 386000	0.48	1.26	445000 100000	362000 81400	1.23	5660000 1270000		LL788345	LL788310	
1066.800 42.0000	1219.200 48.0000	65.088 2.5625	1720000 386000	0.48	1.26	445000 100000	362000 81400	1.23	5660000 1270000		LL788349	LL788310	

<sup>(1)</sup>Based on 1 x 10<sup>6</sup> revolutions L<sub>10</sub> life, for the ISO life-calculation method.

<sup>(2)</sup>Consult your Timken engineer for instructions on use or review the Timken Engineering Manual on timken.com/catalogs.

<sup>(3)</sup>Based on 90 x 10<sup>6</sup> revolutions L<sub>10</sub> life, for The Timken Company life-calculation method. C<sub>90</sub> and C<sub>a90</sub> are radial and thrust values.

Bearing Dimensions											Geometry Factors			Bearing Weight
Width B	Width C	Eff. Ctr. a <sup>(4)</sup>	Shaft			Housing			Cage		G <sub>1</sub>	G <sub>2</sub>	C <sub>g</sub>	
			Max Shaft Fillet Radius R <sup>(5)</sup>	Backing Shoulder Dia. d <sub>a</sub>	Backing Shoulder Dia. d <sub>b</sub>	Max Housing Fillet Radius r <sup>(5)</sup>	Backing Shoulder Dia. D <sub>a</sub>	Backing Shoulder Dia. D <sub>b</sub>	A <sub>a</sub> <sup>(6)</sup>	A <sub>b</sub> <sup>(7)</sup>				
mm in.	mm in.	mm in.	mm in.	mm in.	mm in.	mm in.	mm in.	mm in.	mm in.	mm in.				kg lbs.
<b>58.738</b> 2.3125	<b>41.275</b> 1.6250	<b>79.0</b> 3.11	<b>3.5</b> 0.14	<b>819.0</b> 32.24	<b>822.0</b> 32.36	<b>3.3</b> 0.13	<b>894.0</b> 35.20	<b>888.0</b> 34.96	<b>7.9</b> 0.31	<b>3.2</b> 0.13	12417.2	2699.6	0.3058	<b>52.23</b> 115.17
<b>88.900</b> 3.5000	<b>66.675</b> 2.6250	<b>83.1</b> 3.27	<b>6.4</b> 0.25	<b>861.0</b> 33.90	<b>867.0</b> 34.13	<b>6.4</b> 0.25	<b>1000.9</b> 39.41	<b>996.0</b> 39.21	<b>16.1</b> 0.63	<b>4.8</b> 0.19	14677.1	1745.2	0.3374	<b>173.44</b> 382.38
<b>88.900</b> 3.5000	<b>66.675</b> 2.6250	<b>83.1</b> 3.27	<b>6.4</b> 0.25	<b>867.0</b> 34.13	<b>876.0</b> 34.49	<b>6.4</b> 0.25	<b>1000.9</b> 39.41	<b>996.0</b> 39.21	<b>16.1</b> 0.63	<b>4.8</b> 0.19	14677.1	1745.2	0.3374	<b>163.11</b> 359.61
<b>88.900</b> 3.5000	<b>66.675</b> 2.6250	<b>83.1</b> 3.27	<b>6.4</b> 0.25	<b>870.0</b> 34.25	<b>876.0</b> 34.49	<b>6.4</b> 0.25	<b>1000.9</b> 39.41	<b>996.0</b> 39.21	<b>16.1</b> 0.63	<b>4.8</b> 0.19	14677.1	1745.2	0.3374	<b>161.66</b> 356.40
<b>111.125</b> 4.3750	<b>76.200</b> 3.0000	<b>112.5</b> 4.43	<b>19.0</b> 0.75	<b>894.0</b> 35.20	<b>927.0</b> 36.50	<b>6.4</b> 0.25	<b>1047.4</b> 41.23	<b>1035.0</b> 40.75	<b>22.1</b> 0.87	<b>5.7</b> 0.23	16109.7	1534.4	0.3769	<b>236.94</b> 522.39
<b>185.738</b> 7.3125	<b>138.112</b> 5.4375	<b>14.2</b> 0.56	<b>9.7</b> 0.38	<b>906.0</b> 35.67	<b>915.0</b> 36.02	<b>12.7</b> 0.50	<b>1090.4</b> 42.93	<b>1065.0</b> 41.93	<b>14.6</b> 0.57	<b>-2.2</b> -0.08	28956.1	1086.1	0.3933	<b>465.42</b> 1026.07
<b>111.125</b> 4.3750	<b>76.200</b> 3.0000	<b>124.2</b> 4.89	<b>19.0</b> 0.75	<b>927.0</b> 36.50	<b>957.0</b> 37.68	<b>6.4</b> 0.25	<b>1078.9</b> 42.48	<b>1060.0</b> 41.73	<b>22.1</b> 0.87	<b>6.2</b> 0.25	16994.2	1630.2	0.3871	<b>249.38</b> 549.80
<b>111.125</b> 4.3750	<b>76.200</b> 3.0000	<b>124.2</b> 4.89	<b>19.0</b> 0.75	<b>927.0</b> 36.50	<b>957.0</b> 37.68	<b>6.4</b> 0.25	<b>1078.9</b> 42.48	<b>1060.0</b> 41.73	<b>22.1</b> 0.87	<b>6.2</b> 0.25	16994.2	1630.2	0.3871	<b>249.38</b> 549.80
<b>90.000</b> 3.5433	<b>76.000</b> 2.9921	<b>59.9</b> 2.36	<b>3.3</b> 0.13	<b>951.0</b> 37.44	<b>954.0</b> 37.56	<b>3.3</b> 0.13	<b>1040.0</b> 40.94	<b>1030.0</b> 40.55	<b>5.4</b> 0.21	<b>6.3</b> 0.25	29812.0	4331.9	0.3902	<b>121.25</b> 267.32
<b>90.000</b> 3.5433	<b>76.000</b> 2.9921	<b>59.9</b> 2.36	<b>3.3</b> 0.13	<b>951.0</b> 37.44	<b>954.0</b> 37.56	<b>3.3</b> 0.13	<b>1040.0</b> 40.94	<b>1030.0</b> 40.55	<b>3.5</b> 0.14	<b>8.4</b> 0.33	27827.6	4055.4	0.3807	<b>120.21</b> 265.02
<b>90.000</b> 3.5433	<b>76.000</b> 2.9921	<b>59.9</b> 2.36	<b>3.3</b> 0.13	<b>951.0</b> 37.44	<b>954.0</b> 37.56	<b>3.3</b> 0.13	<b>1040.0</b> 40.94	<b>1030.0</b> 40.55	<b>5.4</b> 0.21	<b>6.0</b> 0.24	29812.0	4331.9	0.3902	<b>119.25</b> 262.78
<b>90.000</b> 3.5433	<b>76.000</b> 2.9921	<b>59.9</b> 2.36	<b>3.3</b> 0.13	<b>951.0</b> 37.44	<b>954.0</b> 37.56	<b>3.3</b> 0.13	<b>1040.0</b> 40.94	<b>1030.0</b> 40.55	<b>3.5</b> 0.14	<b>8.4</b> 0.33	27827.6	4055.4	0.3807	<b>118.18</b> 260.54
<b>133.985</b> 5.2750	<b>110.109</b> 4.3350	<b>58.9</b> 2.32	<b>12.7</b> 0.50	<b>981.0</b> 38.62	<b>1000.0</b> 39.37	<b>12.7</b> 0.50	<b>1157.5</b> 45.57	<b>1135.1</b> 44.69	<b>5.9</b> 0.23	<b>9.3</b> 0.37	26604.7	1717.6	0.3945	<b>356.00</b> 784.86
<b>63.500</b> 2.5000	<b>47.625</b> 1.8750	<b>114.8</b> 4.52	<b>6.4</b> 0.25	<b>1005.0</b> 39.57	<b>1010.0</b> 39.76	<b>6.4</b> 0.25	<b>1100.4</b> 43.32	<b>1095.0</b> 43.11	<b>7.9</b> 0.31	<b>5.0</b> 0.20	18937.3	3190.6	0.3631	<b>101.90</b> 224.68
<b>101.600</b> 4.0000	<b>66.675</b> 2.6250	<b>127.8</b> 5.03	<b>9.7</b> 0.38	<b>1055.0</b> 41.54	<b>1070.0</b> 42.13	<b>9.7</b> 0.38	<b>1214.1</b> 47.80	<b>1210.0</b> 47.64	<b>21.0</b> 0.83	<b>-0.7</b> -0.03	22398.3	3110.1	0.4018	<b>266.85</b> 588.34
<b>65.088</b> 2.5625	<b>42.862</b> 1.6875	<b>142.5</b> 5.61	<b>3.3</b> 0.13	<b>1085.0</b> 42.72	<b>1090.0</b> 42.91	<b>3.3</b> 0.13	<b>1188.8</b> 46.80	<b>1185.0</b> 46.65	<b>7.9</b> 0.31	<b>3.8</b> 0.15	22182.4	4652.2	0.3922	<b>109.42</b> 241.24
<b>65.088</b> 2.5625	<b>42.862</b> 1.6875	<b>142.5</b> 5.61	<b>3.3</b> 0.13	<b>1090.0</b> 42.91	<b>1090.0</b> 42.91	<b>3.3</b> 0.13	<b>1188.8</b> 46.80	<b>1185.0</b> 46.65	<b>7.9</b> 0.31	<b>3.8</b> 0.15	22182.4	4652.2	0.3922	<b>106.72</b> 235.27

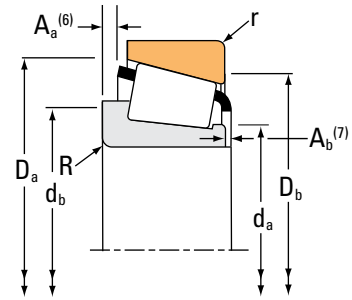
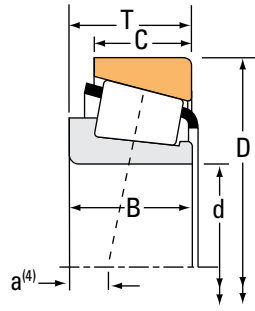
<sup>(4)</sup>Negative value indicates effective center inside cone (inner-ring) backface.  
<sup>(5)</sup>These maximum fillet radii will be cleared by the bearing corners.  
<sup>(6)</sup>Negative value indicates cage extends beyond cone (inner-ring) backface.  
<sup>(7)</sup>Negative value indicates cage that does not extend beyond cone (inner-ring) front face.

Continued on next page.

# TAPERED ROLLER BEARINGS

## SINGLE-ROW • TYPE TS

### TYPE TS



Bearing Dimensions			Load Ratings							Part Number		
Bore d	O.D. D	Width T	Dynamic <sup>(1)</sup>		Factors <sup>(2)</sup>		Dynamic <sup>(3)</sup>		Factors <sup>(2)</sup>	Static	Inner	Outer
			C <sub>1</sub>	e	Y	C <sub>90</sub>	C <sub>a90</sub>	K	C <sub>0</sub>			
mm in.	mm in.	mm in.	N lbf			N lbf	N lbf			N lbf		
<b>1066.800</b> 42.0000	<b>1320.800</b> 52.0000	<b>95.250</b> 3.7500	<b>2670000</b> 599000	0.57	1.05	<b>691000</b> 155000	<b>676000</b> 152000	1.02		<b>6990000</b> 1570000	EE776420	776520
<b>1092.200</b> 43.0000	<b>1320.800</b> 52.0000	* *	<b>2670000</b> 599000	0.57	1.05	<b>691000</b> 155000	<b>676000</b> 152000	1.02		<b>6990000</b> 1570000	EE776430	776520
<b>1155.700</b> 45.5000	<b>1435.100</b> 56.5000	<b>120.650</b> 4.7500	<b>4040000</b> 908000	0.36	1.66	<b>1050000</b> 235000	<b>647000</b> 146000	1.62		<b>13000000</b> 2920000	EE277455	277565
<b>1270.000</b> 50.0000	<b>1435.100</b> 56.5000	<b>69.850</b> 2.7500	<b>1840000</b> 414000	0.57	1.05	<b>478000</b> 107000	<b>467000</b> 105000	1.02		<b>6650000</b> 1500000	LL889049	LL889010
<b>1562.100</b> 61.5000	<b>1806.575</b> 71.1250	<b>127.000</b> 5.0000	<b>4540000</b> 1020000	0.47	1.27	<b>1180000</b> 265000	<b>955000</b> 215000	1.23		<b>16800000</b> 3770000	EE299615	299711

<sup>(1)</sup>Based on  $1 \times 10^6$  revolutions  $L_{10}$  life, for the ISO life-calculation method.

<sup>(2)</sup>Consult your Timken engineer for instructions on use or review the Timken Engineering Manual on [timken.com/catalogs](http://timken.com/catalogs).

<sup>(3)</sup>Based on  $90 \times 10^6$  revolutions  $L_{10}$  life, for The Timken Company life-calculation method.  $C_{90}$  and  $C_{a90}$  are radial and thrust values.

<sup>(\*)</sup>Contact your Timken engineer for details.



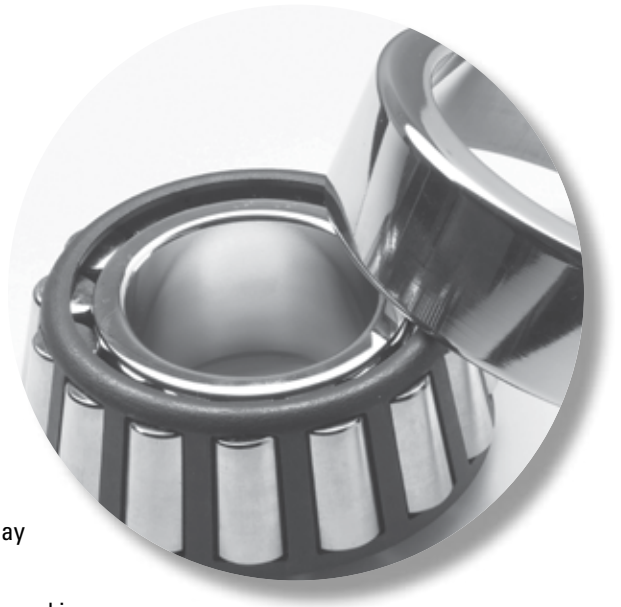
Bearing Dimensions											Geometry Factors			Bearing Weight
Width B	Width C	Eff. Ctr. a <sup>(4)</sup>	Shaft			Housing			Cage		G <sub>1</sub>	G <sub>2</sub>	C <sub>g</sub>	
			Max Shaft Fillet Radius R <sup>(5)</sup>	Backing Shoulder Dia. d <sub>a</sub>	mm in.	Max Housing Fillet Radius r <sup>(5)</sup>	Backing Shoulder Dia. D <sub>a</sub>	mm in.	A <sub>a</sub> <sup>(6)</sup>	A <sub>b</sub> <sup>(7)</sup>				
mm in.	mm in.	mm in.	mm in.	mm in.	mm in.	mm in.	mm in.	mm in.	mm in.	mm in.			kg lbs.	
<b>88.900</b> 3.5000	<b>69.850</b> 2.7500	<b>175.8</b> 6.92	<b>6.4</b> 0.25	<b>1115.0</b> 43.90	<b>1115.0</b> 43.90	<b>6.4</b> 0.25	<b>1273.5</b> 50.14	<b>1260.0</b> 49.61	<b>15.5</b> 0.61	<b>4.9</b> 0.20	23201.8	2946.7	0.4231	<b>268.22</b> 591.29
<b>88.900</b> 3.5000	<b>69.850</b> 2.7500	<b>175.8</b> 6.92	<b>6.4</b> 0.25	<b>1130.0</b> 44.49	<b>1135.0</b> 44.69	<b>6.4</b> 0.25	<b>1273.5</b> 50.14	<b>1260.0</b> 49.61	<b>15.5</b> 0.61	<b>4.9</b> 0.20	23201.8	2946.7	0.4231	<b>238.26</b> 525.24
<b>120.650</b> 4.7500	<b>95.250</b> 3.7500	<b>87.9</b> 3.46	<b>6.4</b> 0.25	<b>1195.0</b> 47.05	<b>1205.0</b> 47.44	<b>6.4</b> 0.25	<b>1370.0</b> 53.94	<b>1370.0</b> 53.94	<b>15.6</b> 0.61	<b>1.6</b> 0.07	40981.4	4107.8	0.4449	<b>432.22</b> 952.86
<b>65.088</b> 2.5625	<b>47.625</b> 1.8750	<b>216.9</b> 8.54	<b>6.4</b> 0.25	<b>1300.0</b> 51.18	<b>1305.0</b> 51.38	<b>6.4</b> 0.25	<b>1403.2</b> 55.24	<b>1395.0</b> 54.92	<b>6.7</b> 0.26	<b>5.9</b> 0.23	31422.7	5654.9	0.4637	<b>147.09</b> 324.30
<b>123.825</b> 4.8750	<b>85.725</b> 3.3750	<b>190.5</b> 7.50	<b>9.7</b> 0.38	<b>1600.0</b> 62.99	<b>1615.0</b> 63.58	<b>9.7</b> 0.38	<b>1757.5</b> 69.19	<b>1700.0</b> 66.93	<b>23.5</b> 0.92	<b>5.6</b> 0.22	69875.1	7454.3	0.5753	<b>477.64</b> 1053.01

(4) Negative value indicates effective center inside cone (inner-ring) backface.  
 (5) These maximum fillet radii will be cleared by the bearing corners.  
 (6) Negative value indicates cage extends beyond cone (inner-ring) backface.  
 (7) Negative value indicates cage that does not extend beyond cone (inner-ring) front face.



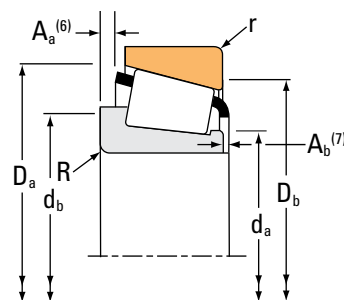
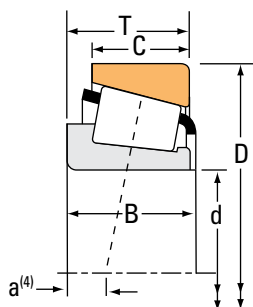
### ***METRIC SINGLE-ROW TAPERED ROLLER BEARINGS***

- Timken offers a comprehensive range of metric part numbers (ISO series and J-prefix).
- Ratings published in this section reflect the standard rating for each part number. Higher performance may be available upon request.
- Consult your Timken engineer before making a final bearing selection to help ensure suitability, availability and the most cost-effective solution.



# TAPERED ROLLER BEARINGS

SINGLE-ROW • Metric



Bearing Dimensions			Load Ratings							Part Number	
Bore d	O.D. D	Width T	Dynamic <sup>(1)</sup>		Factors <sup>(2)</sup>		Dynamic <sup>(3)</sup>		Factors <sup>(2)</sup>	Static C <sub>0</sub>	Assembly Inner/Outer
			C <sub>1</sub>	e	Y	C <sub>90</sub>	C <sub>a90</sub>	K			
mm in.	mm in.	mm in.	N lbf			N lbf	N lbf		N lbf		
15.000 0.5906	42.000 1.6535	14.250 0.5610	26000 5850	0.29	2.11	6750 1520	3290 740	2.05	22200 4980	30302	
17.000 0.6693	40.000 1.5748	13.250 0.5217	21300 4800	0.35	1.74	5530 1240	3270 735	1.69	19900 4460	30203	
17.000 0.6693	47.000 1.8504	15.250 0.6004	32700 7360	0.29	2.11	8480 1910	4140 931	2.05	28400 6390	30303	
20.000 0.7874	42.000 1.6535	15.000 0.5906	27700 6240	0.37	1.60	7190 1620	4600 1040	1.56	29400 6600	32004X	
20.000 0.7874	42.000 1.6535	15.000 0.5906	27700 6240	0.37	1.60	7190 1620	4600 1040	1.56	29400 6600	XAA32004X/YAA32004X	
20.000 0.7874	47.000 1.8504	15.250 0.6004	33200 7470	0.35	1.74	8620 1940	5090 1140	1.69	33000 7420	30204	
20.000 0.7874	47.000 1.8504	19.250 0.7579	41800 9390	0.33	1.81	10800 2430	6150 1380	1.76	43000 9660	32204	
20.000 0.7874	52.000 2.0472	16.250 0.6398	38500 8660	0.30	2.00	9980 2240	5130 1150	1.95	34500 7760	30304	
20.000 0.7874	52.000 2.0472	22.250 0.8760	55200 12400	0.30	2.00	14300 3220	7350 1650	1.95	55000 12400	32304	
25.000 0.9843	47.000 1.8504	15.000 0.5906	30800 6920	0.43	1.39	7980 1790	5880 1320	1.36	35400 7960	32005X	
25.000 0.9843	47.000 1.8504	15.000 0.5906	30800 6920	0.43	1.39	7980 1790	5880 1320	1.36	35400 7960	XAA32005X/YAA32005X	
25.000 0.9843	52.000 2.0472	16.250 0.6398	36900 8300	0.37	1.60	9570 2150	6150 1380	1.56	38300 8620	30205	
25.000 0.9843	52.000 2.0472	19.250 0.7579	42000 9440	0.36	1.67	10900 2450	6710 1510	1.62	42100 9470	32205	
25.000 0.9843	52.000 2.0472	19.250 0.7579	39700 8920	0.58	1.03	10300 2310	10300 2310	1.00	46300 10400	32205B	
25.000 0.9843	52.000 2.0472	22.000 0.8661	55100 12400	0.35	1.71	14300 3210	8590 1930	1.66	63600 14300	33205	
25.000 0.9843	62.000 2.4409	18.250 0.7185	53800 12100	0.30	2.00	13900 3130	7160 1610	1.95	49600 11200	30305	
25.000 0.9843	62.000 2.4409	25.250 0.9941	72400 16300	0.30	2.00	18800 4220	9640 2170	1.95	72400 16300	32305	

<sup>(1)</sup>Based on 1 x 10<sup>6</sup> revolutions L<sub>10</sub> life, for the ISO life-calculation method.

<sup>(2)</sup>Consult your Timken engineer for instructions on use or review the Timken Engineering Manual on timken.com/catalogs.

<sup>(3)</sup>Based on 90 x 10<sup>6</sup> revolutions L<sub>10</sub> life, for The Timken Company life-calculation method. C<sub>90</sub> and C<sub>a90</sub> are radial and thrust values.

Bearing Dimensions											Geometry Factors			Bearing Weight
Width B	Width C	Eff. Ctr. a <sup>(4)</sup>	Shaft			Housing			Cage		G <sub>1</sub>	G <sub>2</sub>	C <sub>g</sub>	
			Max Shaft Fillet Radius R <sup>(5)</sup>	Backing Shoulder Dia. d <sub>a</sub> d <sub>b</sub>		Max Housing Fillet Radius r <sup>(5)</sup>	Backing Shoulder Dia. D <sub>a</sub> D <sub>b</sub>		A <sub>a</sub> <sup>(6)</sup>	A <sub>b</sub> <sup>(7)</sup>				
mm in.	mm in.	mm in.	mm in.	mm in.	mm in.	mm in.	mm in.	mm in.	mm in.	mm in.			kg lbs.	
13.000 0.5118	11.000 0.4331	-4.6 -0.18	1.0 0.04	19.0 0.75	20.5 0.81	1.0 0.04	38.5 1.52	36.5 1.44	-0.4 -0.02	2.1 0.09	4.3	4.6	0.0375	0.11 0.22
12.000 0.4724	11.000 0.4331	-3.6 -0.14	1.0 0.04	21.0 0.83	22.0 0.87	1.0 0.04	37.0 1.46	35.0 1.38	0.1 0.00	1.6 0.07	4.2	6.0	0.0398	0.08 0.18
14.000 0.5512	12.000 0.4724	-4.8 -0.19	1.0 0.04	21.5 0.85	22.5 0.89	1.0 0.04	43.0 1.69	41.5 1.63	-0.3 -0.01	2.2 0.09	5.8	5.0	0.0412	0.14 0.29
15.000 0.5906	12.000 0.4724	-4.6 -0.18	0.6 0.03	25.5 1.00	26.5 1.04	0.6 0.03	39.5 1.56	37.0 1.46	0.4 0.01	1.5 0.06	6.2	6.1	0.0469	0.10 0.21
15.000 0.5906	12.000 0.4724	-4.6 -0.18	2.0 0.08	25.5 1.00	29.0 1.14	1.0 0.04	39.5 1.56	36.5 1.44	0.4 0.01	1.5 0.06	6.2	6.1	0.0469	0.10 0.21
14.000 0.5512	12.000 0.4724	-4.3 -0.17	1.0 0.04	26.0 1.02	27.5 1.08	1.0 0.04	43.5 1.71	41.0 1.61	-0.5 -0.02	2.8 0.11	7.1	7.3	0.0474	0.13 0.28
18.000 0.7087	15.000 0.5906	-6.6 -0.26	1.0 0.04	26.5 1.04	28.5 1.12	1.0 0.04	43.5 1.71	40.5 1.59	0.0 0.00	2.5 0.10	8.2	6.5	0.0493	0.16 0.36
15.000 0.5906	13.000 0.5118	-4.8 -0.19	1.5 0.06	24.5 0.96	27.0 1.06	1.5 0.06	47.5 1.87	45.5 1.79	-0.6 -0.03	2.6 0.11	7.5	5.5	0.0458	2.66 0.38
21.000 0.8268	18.000 0.7087	-7.9 -0.31	1.5 0.06	27.0 1.06	31.0 1.22	1.5 0.06	47.5 1.87	44.0 1.73	-0.1 -0.01	1.8 0.07	10.3	5.9	0.0512	0.24 0.53
15.000 0.5906	11.500 0.4528	-3.3 -0.13	0.6 0.03	30.0 1.18	31.5 1.24	0.6 0.03	44.5 1.75	41.5 1.63	0.0 0.00	1.8 0.07	8.6	8.7	0.0546	0.11 0.25
15.000 0.5906	11.500 0.4528	-3.3 -0.13	3.3 0.13	30.0 1.18	37.0 1.46	1.0 0.04	44.5 1.75	41.0 1.61	0.5 0.02	1.2 0.05	8.6	8.7	0.0546	0.11 0.25
15.000 0.5906	13.000 0.5118	-3.8 -0.15	1.0 0.04	31.0 1.22	32.5 1.28	1.0 0.04	48.5 1.91	45.5 1.79	0.4 0.01	1.9 0.08	9.0	8.0	0.0529	0.15 0.34
18.000 0.7087	16.000 0.6299	-5.3 -0.21	1.0 0.04	31.0 1.22	34.0 1.34	1.0 0.04	49.0 1.93	46.5 1.83	0.5 0.02	1.8 0.07	9.4	7.3	0.0528	0.18 0.40
18.000 0.7087	15.000 0.5906	-3.0 -0.12	1.0 0.04	31.0 1.22	36.0 1.42	1.0 0.04	49.5 1.95	43.5 1.71	1.7 0.06	1.6 0.07	10.2	9.1	0.0637	0.19 0.42
22.000 0.8661	18.000 0.7087	-7.6 -0.30	1.0 0.04	30.5 1.20	34.0 1.34	1.0 0.04	49.0 1.93	44.5 1.75	0.6 0.02	2.0 0.08	13.4	8.6	0.0594	0.23 0.50
17.000 0.6693	15.000 0.5906	-5.1 -0.20	1.5 0.06	32.5 1.28	34.5 1.36	1.5 0.06	57.5 2.26	55.0 2.17	-0.5 -0.02	3.3 0.13	11.8	8.5	0.0532	0.26 0.58
24.000 0.9449	20.000 0.7874	-9.7 -0.38	1.5 0.06	31.5 1.24	35.0 1.38	1.5 0.06	57.0 2.24	54.0 2.13	2.1 0.08	2.3 0.09	15.1	7.2	0.0580	0.37 0.81

<sup>(4)</sup>Negative value indicates effective center inside cone (inner-ring) backface.

<sup>(5)</sup>These maximum fillet radii will be cleared by the bearing corners.

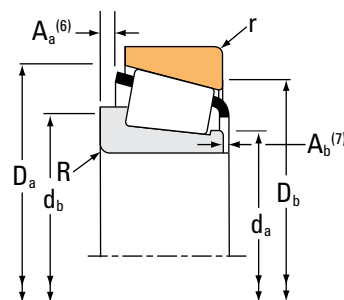
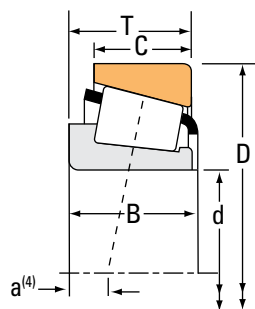
<sup>(6)</sup>Negative value indicates cage extends beyond cone (inner-ring) backface.

<sup>(7)</sup>Negative value indicates cage that does not extend beyond cone (inner-ring) front face.

Continued on next page.

# TAPERED ROLLER BEARINGS

SINGLE-ROW • Metric



Bearing Dimensions			Load Ratings							Part Number	
Bore d	O.D. D	Width T	Dynamic <sup>(1)</sup>		Factors <sup>(2)</sup>		Dynamic <sup>(3)</sup>		Factors <sup>(2)</sup>	Static C <sub>0</sub>	Assembly Inner/Outer
			C <sub>1</sub>	e	Y	C <sub>90</sub>	C <sub>a90</sub>	K	C <sub>0</sub>		
mm in.	mm in.	mm in.	N lbf			N lbf	N lbf		N lbf		
30.000 1.1811	55.000 2.1654	17.000 0.6693	39200 8810	0.43	1.39	10200 2280	7480 1680	1.36	45300 10200	32006X	
30.000 1.1811	62.000 2.4409	17.250 0.6791	49300 11100	0.37	1.60	12800 2880	8210 1850	1.56	43800 9860	30206	
30.000 1.1811	62.000 2.4409	21.250 0.8366	64100 14400	0.37	1.60	16600 3740	10700 2400	1.56	71900 16200	32206	
30.000 1.1811	62.000 2.4409	21.250 0.8366	55800 12500	0.56	1.07	14500 3250	13900 3130	1.04	62300 14000	32206B	
30.000 1.1811	62.000 2.4409	25.000 0.9843	73900 16600	0.34	1.76	19200 4310	11200 2520	1.71	82200 18500	33206	
30.000 1.1811	72.000 2.8346	20.750 0.8169	67700 15200	0.31	1.90	17500 3940	9460 2130	1.85	65300 14700	30306	
30.000 1.1811	72.000 2.8346	28.750 1.1319	87600 19700	0.31	1.90	22700 5110	12300 2750	1.85	89800 20200	32306	
30.000 1.1811	72.000 2.8346	29.370 1.1563	87000 19600	0.55	1.10	22600 5070	21100 4740	1.07	111000 24900	JHM88540/JHM88513	
35.000 1.3780	62.000 2.4409	18.000 0.7087	47700 10700	0.45	1.32	12400 2780	9600 2160	1.29	57600 12900	32007X	
35.000 1.3780	72.000 2.8346	18.250 0.7185	60600 13600	0.37	1.60	15700 3530	10100 2270	1.56	63600 14300	30207	
35.000 1.3780	72.000 2.8346	24.250 0.9547	74900 16800	0.37	1.60	19400 4370	12500 2800	1.56	82300 18500	32207	
35.000 1.3780	72.000 2.8346	28.000 1.1024	99900 22500	0.35	1.70	25900 5820	15700 3520	1.65	116000 26200	33207	
35.000 1.3780	80.000 3.1496	22.750 0.8957	72800 16400	0.83	0.73	18900 4250	26700 6000	0.71	74800 16800	31307	
35.000 1.3780	80.000 3.1496	22.750 0.8957	87200 19600	0.31	1.90	22600 5080	12200 2740	1.85	86100 19300	30307	
35.000 1.3780	80.000 3.1496	32.750 1.2894	116000 26000	0.31	1.90	30000 6740	16200 3640	1.85	123000 27700	32307	
40.000 1.5748	68.000 2.6772	19.000 0.7480	55500 12500	0.38	1.58	14400 3240	9330 2100	1.54	71600 16100	32008X	
40.000 1.5748	68.000 2.6772	19.000 0.7480	55500 12500	0.38	1.58	14400 3240	9330 2100	1.54	71600 16100	XAA32008X/Y32008X	

<sup>(1)</sup>Based on 1 x 10<sup>6</sup> revolutions L<sub>10</sub> life, for the ISO life-calculation method.

<sup>(2)</sup>Consult your Timken engineer for instructions on use or review the Timken Engineering Manual on timken.com/catalogs.

<sup>(3)</sup>Based on 90 x 10<sup>6</sup> revolutions L<sub>10</sub> life, for The Timken Company life-calculation method. C<sub>90</sub> and C<sub>a90</sub> are radial and thrust values.

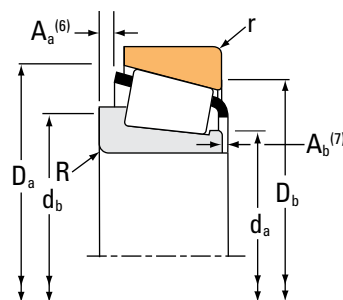
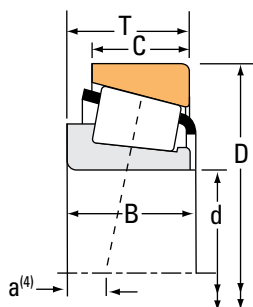
Bearing Dimensions											Geometry Factors			Bearing Weight
Width B	Width C	Eff. Ctr. a <sup>(4)</sup>	Shaft			Housing			Cage		G <sub>1</sub>	G <sub>2</sub>	C <sub>g</sub>	
			Max Shaft Fillet Radius R <sup>(5)</sup>	Backing Shoulder Dia. d <sub>a</sub> d <sub>b</sub>		Max Housing Fillet Radius r <sup>(5)</sup>	Backing Shoulder Dia. D <sub>a</sub> D <sub>b</sub>		A <sub>a</sub> <sup>(6)</sup>	A <sub>b</sub> <sup>(7)</sup>				
mm in.	mm in.	mm in.	mm in.	mm in.	mm in.	mm in.	mm in.	mm in.	mm in.	mm in.			kg lbs.	
17.000 0.6693	13.000 0.5118	-3.3 -0.13	1.0 0.04	36.0 1.42	37.5 1.48	1.0 0.04	52.0 2.05	49.0 1.93	0.9 0.03	1.3 0.06	12.1	10.5	0.0611	0.18 0.38
16.000 0.6299	14.000 0.5512	-3.3 -0.13	1.0 0.04	35.0 1.38	36.0 1.42	1.0 0.04	58.0 2.28	55.0 2.17	0.2 0.00	2.4 0.10	11.9	9.4	0.0577	0.23 0.51
20.000 0.7874	17.000 0.6693	-5.6 -0.22	1.0 0.04	37.0 1.46	43.0 1.69	1.0 0.04	59.0 2.32	54.0 2.13	0.7 0.03	2.6 0.11	16.8	10.9	0.0652	0.29 0.66
20.000 0.7874	17.000 0.6693	-3.3 -0.13	1.0 0.04	36.5 1.44	39.5 1.56	1.0 0.04	59.0 2.32	53.0 2.09	1.6 0.06	2.9 0.12	14.1	8.9	0.0700	0.30 0.65
25.000 0.9843	19.500 0.7677	-9.1 -0.36	1.0 0.04	36.5 1.44	40.0 1.57	1.0 0.04	59.0 2.32	55.0 2.17	1.0 0.04	2.8 0.11	18.6	9.8	0.0654	0.35 0.78
19.000 0.7480	16.000 0.6299	-5.6 -0.22	1.5 0.06	38.0 1.50	40.0 1.57	1.5 0.06	67.0 2.64	63.0 2.48	1.2 0.04	3.3 0.13	16.8	10.3	0.0609	0.39 0.88
27.000 1.0630	23.000 0.9055	-10.7 -0.42	1.5 0.06	37.0 1.46	40.5 1.59	1.5 0.06	66.0 2.60	62.0 2.44	2.9 0.11	2.8 0.11	20.6	8.6	0.0654	0.56 1.23
27.783 1.0938	23.020 0.9063	-5.6 -0.22	1.3 0.05	42.5 1.67	44.5 1.75	3.3 0.13	69.0 2.72	58.0 2.28	1.5 0.06	2.3 0.09	26.3	8.7	0.0857	0.61 1.34
18.000 0.7087	14.000 0.5512	-2.5 -0.10	1.0 0.04	41.5 1.63	43.0 1.69	1.0 0.04	59.5 2.34	55.0 2.17	0.8 0.03	1.4 0.06	16.7	15.7	0.0691	0.22 0.50
17.000 0.6693	15.000 0.5906	-3.3 -0.13	1.5 0.06	42.5 1.67	44.5 1.75	1.5 0.06	67.0 2.64	64.0 2.52	0.0 0.00	3.3 0.13	18.0	13.3	0.0662	0.34 0.74
23.000 0.9055	19.000 0.7480	-6.3 -0.25	1.5 0.06	41.5 1.63	43.5 1.71	1.5 0.06	67.0 2.64	63.0 2.48	1.9 0.07	1.8 0.07	21.5	11.4	0.0705	0.44 0.96
28.000 1.1024	22.000 0.8661	-9.4 -0.37	1.5 0.06	42.0 1.65	45.5 1.79	1.5 0.06	68.0 2.68	63.0 2.48	1.5 0.06	2.8 0.11	27.5	11.1	0.0754	0.53 1.17
21.000 0.8268	15.000 0.5906	3.3 0.13	2.0 0.08	45.0 1.77	56.0 2.20	1.5 0.06	76.0 2.99	68.0 2.68	2.5 0.10	3.6 0.14	17.8	8.7	0.0839	0.55 1.21
21.000 0.8268	18.000 0.7087	-5.8 -0.23	2.0 0.08	43.5 1.71	46.5 1.83	1.5 0.06	75.0 2.95	72.0 2.83	0.5 0.02	4.0 0.16	22.9	10.1	0.0674	0.53 1.16
31.000 1.2205	25.000 0.9843	-12.2 -0.48	2.0 0.08	43.0 1.69	46.0 1.81	1.5 0.06	74.0 2.91	70.0 2.76	3.6 0.14	2.8 0.11	29.0	10.1	0.0733	0.75 1.66
19.000 0.7480	14.500 0.5709	-3.8 -0.15	1.0 0.04	45.5 1.79	47.0 1.85	1.0 0.04	65.0 2.56	61.0 2.40	0.9 0.03	1.7 0.07	23.8	16.1	0.0732	0.27 0.61
19.000 0.7480	14.500 0.5709	-3.8 -0.15	3.5 0.14	45.5 1.79	52.1 2.05	1.0 0.04	65.0 2.56	61.0 2.40	0.9 0.03	1.7 0.07	23.8	16.1	0.0732	0.27 0.61

<sup>(4)</sup>Negative value indicates effective center inside cone (inner-ring) backface.  
<sup>(5)</sup>These maximum fillet radii will be cleared by the bearing corners.  
<sup>(6)</sup>Negative value indicates cage extends beyond cone (inner-ring) backface.  
<sup>(7)</sup>Negative value indicates cage that does not extend beyond cone (inner-ring) front face.  
<sup>(\*)</sup>Contact your Timken engineer for details.

Continued on next page.

# TAPERED ROLLER BEARINGS

SINGLE-ROW • Metric



Bearing Dimensions			Load Ratings							Part Number	
Bore d	O.D. D	Width T	Dynamic <sup>(1)</sup>		Factors <sup>(2)</sup>		Dynamic <sup>(3)</sup>		Factors <sup>(2)</sup>	Static C <sub>0</sub>	Assembly Inner/Outer
			C <sub>1</sub>	e	Y	C <sub>90</sub>	C <sub>a90</sub>	K			
mm in.	mm in.	mm in.	N lbf			N lbf	N lbf		N lbf		
40.000 1.5748	75.000 2.9528	26.000 1.0236	88000 19800	0.36	1.69	22800 5130	13900 3120	1.64	105000 23600	33108	
40.000 1.5748	75.000 2.9528	26.000 1.0236	88000 19800	0.36	1.69	22800 5130	13900 3120	1.64	105000 23600	XAA33108/Y33108	
40.000 1.5748	80.000 3.1496	19.750 0.7776	70900 15900	0.37	1.60	18400 4130	11800 2650	1.56	74700 16800	30208	
40.000 1.5748	80.000 3.1496	24.750 0.9744	88300 19900	0.37	1.60	22900 5150	14700 3310	1.56	98000 22000	32208	
40.000 1.5748	80.000 3.1496	32.000 1.2598	121000 27200	0.36	1.68	31300 7040	19200 4310	1.63	144000 32400	33208	
40.000 1.5748	85.000 3.3465	33.000 1.2992	137000 30800	0.34	1.74	35500 7990	20900 4710	1.70	160000 35900	JF4049/JF4010	
40.000 1.5748	90.000 3.5433	25.250 0.9941	85300 19200	0.83	0.73	22100 4970	31200 7020	0.71	88100 19800	31308	
40.000 1.5748	90.000 3.5433	25.250 0.9941	98700 22200	0.35	1.74	25600 5760	15100 3400	1.69	102000 23000	30308	
40.000 1.5748	90.000 3.5433	35.250 1.3878	133000 30000	0.35	1.74	34600 7770	20400 4590	1.69	150000 33700	32308	
40.000 1.5748	90.000 3.5433	35.250 1.3878	132000 29700	0.55	1.10	34300 7710	32100 7210	1.07	160000 36100	32308B	
45.000 1.7717	75.000 2.9528	20.000 0.7874	66400 14900	0.39	1.53	17200 3870	11600 2600	1.49	84300 19000	32009X	
45.000 1.7717	75.000 2.9528	20.000 0.7874	66400 14900	0.39	1.53	17200 3870	11600 2600	1.49	84300 19000	XAA32009X/Y32009X	
45.000 1.7717	80.000 3.1496	26.000 1.0236	95100 21400	0.38	1.57	24600 5540	16200 3640	1.52	119000 26800	33109	
45.000 1.7717	85.000 3.3465	20.750 0.8169	80000 18000	0.40	1.48	20700 4660	14400 3230	1.44	89000 20000	30209	
45.000 1.7717	85.000 3.3465	24.750 0.9744	87500 19700	0.40	1.48	22700 5100	15700 3540	1.44	98700 22200	32209	
45.000 1.7717	85.000 3.3465	32.000 1.2598	125000 28200	0.39	1.56	32500 7310	21500 4820	1.51	155000 34800	33209	
45.000 1.7717	95.000 3.7402	29.000 1.1417	99900 22500	0.87	0.69	25900 5820	38400 8630	0.67	114000 25600	JW4549/JW4510	

<sup>(1)</sup>Based on 1 x 10<sup>6</sup> revolutions L<sub>10</sub> life, for the ISO life-calculation method.

<sup>(2)</sup>Consult your Timken engineer for instructions on use or review the Timken Engineering Manual on timken.com/catalogs.

<sup>(3)</sup>Based on 90 x 10<sup>6</sup> revolutions L<sub>10</sub> life, for The Timken Company life-calculation method. C<sub>90</sub> and C<sub>a90</sub> are radial and thrust values.



Bearing Dimensions											Geometry Factors			Bearing Weight
Width B	Width C	Eff. Ctr. a <sup>(4)</sup>	Shaft			Housing			Cage		G <sub>1</sub>	G <sub>2</sub>	C <sub>g</sub>	
			Max Shaft Fillet Radius R <sup>(5)</sup>	Backing Shoulder Dia. d <sub>a</sub> d <sub>b</sub>		Max Housing Fillet Radius r <sup>(5)</sup>	Backing Shoulder Dia. D <sub>a</sub> D <sub>b</sub>		A <sub>a</sub> <sup>(6)</sup>	A <sub>b</sub> <sup>(7)</sup>				
mm in.	mm in.	mm in.	mm in.	mm in.	mm in.	mm in.	mm in.	mm in.	mm in.	mm in.			kg lbs.	
26.000 1.0236	20.500 0.8071	-7.6 -0.30	1.5 0.06	47.0 1.85	51.0 2.01	1.5 0.06	72.0 2.83	67.0 2.64	1.3 0.05	2.3 0.09	29.4	14.9	0.0771	0.49 1.08
26.000 1.0236	20.500 0.8071	-7.6 -0.30	3.5 0.14	47.0 1.85	55.0 2.17	1.5 0.06	72.0 2.83	67.0 2.64	1.8 0.07	1.7 0.07	29.4	14.9	0.0771	0.50 1.09
18.000 0.7087	16.000 0.6299	-3.0 -0.12	1.5 0.06	47.5 1.87	49.5 1.95	1.5 0.06	75.0 2.95	71.0 2.80	0.0 0.00	3.6 0.14	22.5	14.3	0.0712	0.43 0.94
23.000 0.9055	19.000 0.7480	-5.6 -0.22	1.5 0.06	46.0 1.81	48.5 1.91	1.5 0.06	75.0 2.95	71.0 2.80	1.6 0.06	2.5 0.10	25.0	11.4	0.0738	0.53 1.17
32.000 1.2598	25.000 0.9843	-10.9 -0.43	1.5 0.06	47.0 1.85	51.0 2.01	1.5 0.06	76.0 2.99	70.0 2.76	2.8 0.11	2.5 0.10	35.9	11.4	0.0827	0.73 1.61
32.500 1.2795	28.000 1.1024	-10.2 -0.40	2.5 0.10	49.0 1.93	55.0 2.17	2.0 0.08	80.0 3.15	75.0 2.95	0.5 0.02	2.5 0.10	39.5	13.6	0.0841	0.90 1.99
23.000 0.9055	17.000 0.6693	4.1 0.16	2.0 0.08	52.0 2.05	61.0 2.40	1.5 0.06	86.0 3.39	76.0 2.99	4.0 0.16	3.1 0.13	22.9	10.3	0.0910	0.73 1.59
23.000 0.9055	20.000 0.7874	-5.8 -0.23	2.0 0.08	46.5 1.83	50.0 1.97	1.5 0.06	84.0 3.31	80.0 3.15	1.8 0.07	2.8 0.11	30.1	11.6	0.0762	0.73 1.61
33.000 1.2992	27.000 1.0630	-11.9 -0.47	2.0 0.08	51.0 2.01	55.0 2.17	1.5 0.06	83.0 3.27	78.0 3.07	3.8 0.15	2.8 0.11	38.5	12.6	0.0832	1.02 2.26
33.000 1.2992	27.000 1.0630	-7.4 -0.29	2.0 0.08	49.0 1.93	58.0 2.28	1.5 0.06	84.0 3.31	76.0 2.99	3.5 0.13	3.4 0.14	38.1	14.0	0.0966	1.10 2.43
20.000 0.7874	15.500 0.6102	-3.3 -0.13	1.0 0.04	51.0 2.01	53.0 2.09	1.0 0.04	72.0 2.83	68.0 2.68	0.5 0.02	2.2 0.09	28.7	16.2	0.0788	0.34 0.76
20.000 0.7874	15.500 0.6102	-3.3 -0.13	3.0 0.12	51.0 2.01	57.0 2.24	1.0 0.04	72.0 2.83	68.0 2.68	0.5 0.02	2.2 0.09	28.7	16.2	0.0788	0.34 0.76
26.000 1.0236	20.500 0.8071	-6.6 -0.26	1.5 0.06	52.0 2.05	55.0 2.17	1.5 0.06	76.0 2.99	71.0 2.80	1.9 0.07	1.7 0.07	35.7	16.5	0.0843	0.54 1.17
19.000 0.7480	16.000 0.6299	-2.5 -0.10	1.5 0.06	53.0 2.09	55.0 2.17	1.5 0.06	80.0 3.15	76.0 2.99	1.0 0.04	3.9 0.16	28.3	16.3	0.0789	0.49 1.08
23.000 0.9055	19.000 0.7480	-4.3 -0.17	1.5 0.06	51.0 2.01	54.0 2.13	1.5 0.06	81.0 3.19	76.0 2.99	1.6 0.06	2.6 0.10	30.5	13.8	0.0809	0.58 1.27
32.000 1.2598	25.000 0.9843	-9.9 -0.39	1.5 0.06	52.0 2.05	57.0 2.24	1.5 0.06	81.0 3.19	74.0 2.91	2.9 0.11	2.5 0.10	41.9	14.5	0.0892	0.79 1.73
26.500 1.0433	20.000 0.7874	4.0 0.16	2.5 0.10	54.0 2.13	64.0 2.52	2.5 0.10	90.0 3.56	78.0 3.07	3.8 0.15	3.6 0.14	30.7	12.9	0.1020	0.91 2.00

<sup>(4)</sup>Negative value indicates effective center inside cone (inner-ring) backface.

<sup>(5)</sup>These maximum fillet radii will be cleared by the bearing corners.

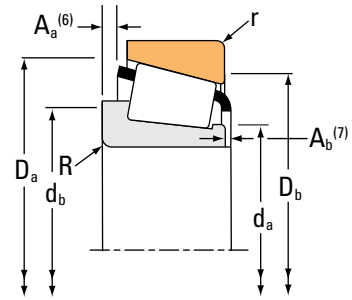
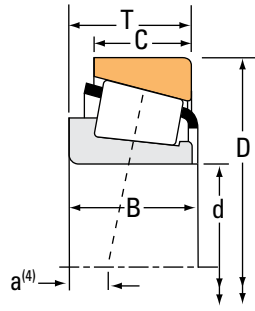
<sup>(6)</sup>Negative value indicates cage extends beyond cone (inner-ring) backface.

<sup>(7)</sup>Negative value indicates cage that does not extend beyond cone (inner-ring) front face.

Continued on next page.

# TAPERED ROLLER BEARINGS

SINGLE-ROW • Metric



Bearing Dimensions			Load Ratings							Part Number		
Bore d	O.D. D	Width T	Dynamic <sup>(1)</sup>		Factors <sup>(2)</sup>		Dynamic <sup>(3)</sup>		Factors <sup>(2)</sup>		Static C <sub>0</sub>	Assembly Inner/Outer
			C <sub>1</sub>	e	Y	C <sub>90</sub>	C <sub>a90</sub>	K	C <sub>0</sub>			
mm in.	mm in.	mm in.	N lbf			N lbf	N lbf		N lbf			
45.000 1.7717	100.000 3.9370	27.250 1.0728	106000 23800	0.83	0.73	27400 6160	38700 8700	0.71	113000 25400		31309	
45.000 1.7717	100.000 3.9370	27.250 1.0728	129000 29000	0.35	1.74	33500 7530	19800 4450	1.69	139000 31300		30309	
45.000 1.7717	100.000 3.9370	38.250 1.5059	154000 34600	0.35	1.74	39900 8980	23600 5300	1.69	171000 38600		32309	
45.000 1.7717	100.000 3.9370	38.250 1.5059	159000 35800	0.55	1.10	41300 9290	38600 8680	1.07	187000 42100		32309B	
50.000 1.9685	80.000 3.1496	20.000 0.7874	69800 15700	0.42	1.42	18100 4070	13100 2950	1.38	92700 20800		32010X	
50.000 1.9685	80.000 3.1496	20.000 0.7874	69800 15700	0.42	1.42	18100 4070	13100 2950	1.38	92700 20800		XAA32010X/Y32010X	
50.000 1.9685	80.000 3.1496	20.000 0.7874	69800 15700	0.42	1.42	18100 4070	13100 2950	1.38	92700 20800		XAB32010X/Y32010X	
50.000 1.9685	80.000 3.1496	24.000 0.9449	80600 18100	0.32	1.90	20900 4700	11300 2550	1.85	112000 25300		33010	
50.000 1.9685	82.000 3.2283	21.500 0.8465	81300 18300	0.31	1.97	21100 4740	11000 2470	1.91	104000 23400		JLM104948/JLM104910	
50.000 1.9685	84.000 3.3071	22.000 0.8661	81400 18300	0.44	1.37	21100 4740	15800 3550	1.34	104000 23500		JLM704649/JLM704610	
50.000 1.9685	85.000 3.3465	26.000 1.0236	96700 21700	0.41	1.46	25100 5630	17600 3970	1.42	125000 28100		33110	
50.000 1.9685	90.000 3.5433	21.750 0.8563	79500 17900	0.42	1.43	20600 4630	14800 3330	1.39	87400 19700		30210	
50.000 1.9685	90.000 3.5433	24.750 0.9744	99800 22400	0.42	1.43	25900 5820	18600 4180	1.39	118000 26500		32210	
50.000 1.9685	90.000 3.5433	28.000 1.1024	124000 27800	0.33	1.82	32100 7210	18100 4060	1.78	154000 34600		JM205149/JM205110	
50.000 1.9685	90.000 3.5433	32.000 1.2598	130000 29200	0.41	1.45	33600 7560	23800 5360	1.41	166000 37300		33210	
50.000 1.9685	105.000 4.1339	32.000 1.2598	119000 26800	0.87	0.69	31000 6960	45900 10300	0.67	138000 31000		JW5049/JW5010	
50.000 1.9685	105.000 4.1339	37.000 1.4567	172000 38600	0.49	1.23	44500 10000	37100 8350	1.20	223000 50200		JHM807045/JHM807012	

<sup>(1)</sup>Based on 1 x 10<sup>6</sup> revolutions L<sub>10</sub> life, for the ISO life-calculation method.

<sup>(2)</sup>Consult your Timken engineer for instructions on use or review the Timken Engineering Manual on timken.com/catalogs.

<sup>(3)</sup>Based on 90 x 10<sup>6</sup> revolutions L<sub>10</sub> life, for The Timken Company life-calculation method. C<sub>90</sub> and C<sub>a90</sub> are radial and thrust values.

Bearing Dimensions											Geometry Factors			Bearing Weight
Width B	Width C	Eff. Ctr. a <sup>(4)</sup>	Shaft			Housing			Cage		G <sub>1</sub>	G <sub>2</sub>	C <sub>g</sub>	
			Max Shaft Fillet Radius R <sup>(5)</sup>	Backing Shoulder Dia. d <sub>a</sub> d <sub>b</sub>		Max Housing Fillet Radius r <sup>(5)</sup>	Backing Shoulder Dia. D <sub>a</sub> D <sub>b</sub>		A <sub>a</sub> <sup>(6)</sup>	A <sub>b</sub> <sup>(7)</sup>				
mm in.	mm in.	mm in.	mm in.	mm in.	mm in.	mm in.	mm in.	mm in.	mm in.	mm in.				kg lbs.
25.000 0.9843	18.000 0.7087	4.3 0.17	2.0 0.08	56.0 2.20	67.0 2.64	1.5 0.06	95.5 3.76	85.0 3.35	5.4 0.21	3.8 0.15	30.4	12.7	0.1001	0.94 2.07
25.000 0.9843	22.000 0.8661	-6.1 -0.24	2.0 0.08	56.0 2.20	59.0 2.32	1.5 0.06	93.0 3.66	89.0 3.50	0.7 0.02	4.0 0.16	41.9	18.4	0.0836	1.01 2.22
36.000 1.4173	30.000 1.1811	-13.0 -0.51	2.0 0.08	54.0 2.13	57.0 2.24	1.5 0.06	93.0 3.66	87.0 3.43	4.1 0.16	3.6 0.14	47.5	14.2	0.0891	1.36 3.01
36.000 1.4173	30.000 1.1811	-7.9 -0.31	2.0 0.08	54.0 2.13	68.0 2.68	1.5 0.06	95.0 3.74	84.0 3.31	3.5 0.14	1.8 0.08	45.0	17.2	0.1018	1.42 3.13
20.000 0.7874	15.500 0.6102	-2.0 -0.08	1.0 0.04	56.0 2.20	58.0 2.28	1.0 0.04	77.0 3.03	73.0 2.87	0.9 0.03	2.1 0.09	34.0	20.3	0.0853	0.36 0.82
20.000 0.7874	15.500 0.6102	-2.0 -0.08	2.3 0.09	56.0 2.20	60.0 2.36	1.0 0.04	77.0 3.03	73.0 2.87	0.9 0.03	2.1 0.09	34.0	20.3	0.0853	0.36 0.82
20.000 0.7874	15.500 0.6102	-2.0 -0.08	3.0 0.12	55.0 2.17	62.0 2.44	1.0 0.04	77.0 3.03	73.0 2.87	0.5 0.02	2.5 0.10	34.0	20.3	0.0853	0.36 0.82
24.000 0.9449	19.000 0.7480	-6.6 -0.26	1.0 0.04	55.0 2.17	57.0 2.24	1.0 0.04	77.0 3.03	73.0 2.87	0.8 0.03	2.5 0.10	42.3	28.0	0.0836	0.45 1.00
21.500 0.8465	17.000 0.6693	-5.3 -0.21	3.0 0.12	55.0 2.17	60.0 2.36	0.5 0.02	78.0 3.07	76.0 2.99	0.3 0.01	2.8 0.11	38.8	19.3	0.0801	0.45 1.00
22.000 0.8661	17.500 0.6890	-2.3 -0.09	3.5 0.14	56.0 2.20	64.0 2.52	1.5 0.06	80.0 3.15	76.0 2.99	0.8 0.03	2.0 0.08	35.6	16.7	0.0876	0.47 1.03
26.000 1.0236	20.000 0.7874	-5.3 -0.21	1.5 0.06	57.0 2.24	61.0 2.40	1.5 0.06	82.0 3.23	76.0 2.99	2.3 0.09	1.7 0.07	40.6	20.7	0.0899	0.58 1.29
20.000 0.7874	17.000 0.6693	-2.0 -0.08	1.5 0.06	56.0 2.20	59.0 2.32	1.5 0.06	85.0 3.35	81.0 3.19	1.3 0.05	3.1 0.13	30.3	15.9	0.0814	0.54 1.19
23.000 0.9055	19.000 0.7480	-3.6 -0.14	1.5 0.06	58.0 2.28	61.0 2.40	1.5 0.06	86.0 3.39	81.0 3.19	1.5 0.06	3.8 0.15	37.4	17.2	0.0877	0.63 1.39
28.000 1.1024	23.000 0.9055	-7.6 -0.30	3.0 0.12	57.0 2.24	63.0 2.48	2.5 0.10	85.0 3.35	80.0 3.15	0.3 0.01	2.8 0.11	48.2	15.2	0.0885	0.74 1.64
32.000 1.2598	24.500 0.9646	-8.6 -0.34	1.5 0.06	57.0 2.24	61.0 2.40	1.5 0.06	86.0 3.39	80.0 3.15	2.8 0.11	3.0 0.12	48.4	16.9	0.0957	0.84 1.86
29.000 1.1417	22.000 0.8661	4.3 0.17	3.0 0.12	60.0 2.36	76.0 2.99	3.0 0.12	100.0 3.94	86.0 3.39	4.1 0.16	4.1 0.16	39.0	14.6	0.1100	1.23 2.72
36.000 1.4173	29.000 1.1417	-7.6 -0.30	3.0 0.12	63.0 2.48	69.0 2.72	2.5 0.10	100.0 3.94	90.0 3.54	3.0 0.12	3.0 0.12	63.9	17.1	0.0760	1.50 3.31

<sup>(4)</sup>Negative value indicates effective center inside cone (inner-ring) backface.

<sup>(5)</sup>These maximum fillet radii will be cleared by the bearing corners.

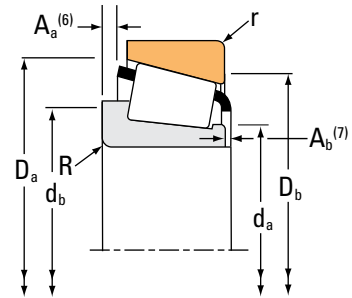
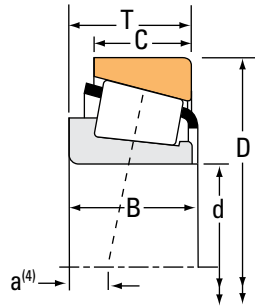
<sup>(6)</sup>Negative value indicates cage extends beyond cone (inner-ring) backface.

<sup>(7)</sup>Negative value indicates cage that does not extend beyond cone (inner-ring) front face.

Continued on next page.

# TAPERED ROLLER BEARINGS

SINGLE-ROW • Metric



Bearing Dimensions			Load Ratings							Part Number		
Bore d	O.D. D	Width T	Dynamic <sup>(1)</sup>		Factors <sup>(2)</sup>		Dynamic <sup>(3)</sup>		Factors <sup>(2)</sup>		Static C <sub>0</sub>	Assembly Inner/Outer
			C <sub>1</sub>	e	Y	C <sub>90</sub>	C <sub>a90</sub>	K	C <sub>0</sub>			
mm in.	mm in.	mm in.	N lbf			N lbf	N lbf		N lbf			
50.000 1.9685	110.000 4.3307	29.250 1.1516	124000 28000	0.83	0.73	32300 7250	45600 10200	0.71	132000 29700		31310	
50.000 1.9685	110.000 4.3307	29.250 1.1516	149000 33400	0.35	1.74	38500 8660	22700 5110	1.69	160000 36000		30310	
50.000 1.9685	110.000 4.3307	42.250 1.6634	187000 42000	0.35	1.74	48400 10900	28600 6430	1.69	211000 47500		32310	
50.000 1.9685	110.000 4.3307	42.250 1.6634	193000 43400	0.55	1.10	50000 11200	46800 10500	1.07	241000 54300		32310B	
55.000 2.1654	90.000 3.5433	23.000 0.9055	91800 20600	0.40	1.49	23800 5350	16400 3680	1.45	123000 27600		JLM506849/JLM506810	
55.000 2.1654	90.000 3.5433	23.000 0.9055	94900 21300	0.41	1.48	24600 5530	17100 3850	1.44	126000 28300		32011X	
55.000 2.1654	90.000 3.5433	27.000 1.0630	99500 22400	0.31	1.92	25800 5800	13800 3100	1.87	141000 31700		33011	
55.000 2.1654	95.000 3.7402	29.000 1.1417	131000 29300	0.33	1.79	33800 7610	19400 4360	1.74	168000 37700		JM207049/JM207010	
55.000 2.1654	95.000 3.7402	30.000 1.1811	133000 29900	0.37	1.60	34500 7760	22100 4970	1.56	166000 37200		33111	
55.000 2.1654	100.000 3.9370	22.750 0.8957	107000 24000	0.40	1.48	27700 6230	19200 4320	1.44	122000 27400		30211	
55.000 2.1654	100.000 3.9370	26.750 1.0531	121000 27200	0.40	1.48	31300 7040	21700 4880	1.44	141000 31600		32211	
55.000 2.1654	100.000 3.9370	35.000 1.3780	162000 36400	0.40	1.50	42000 9440	28700 6460	1.46	202000 45300		33211	
55.000 2.1654	110.000 4.3307	39.000 1.5354	210000 47200	0.35	1.73	54400 12200	32300 7260	1.69	251000 56500		JH307749/JH307710	
55.000 2.1654	115.000 4.5276	34.000 1.3386	145000 32700	0.87	0.69	37700 8470	55800 12600	0.67	175000 39200		JW5549/JW5510	
55.000 2.1654	120.000 4.7244	31.500 1.2402	174000 39100	0.35	1.74	45100 10100	26600 5990	1.69	190000 42700		30311	
55.000 2.1654	120.000 4.7244	31.500 1.2402	145000 32600	0.83	0.73	37600 8460	53100 11900	0.71	157000 35300		31311	
55.000 2.1654	120.000 4.7244	45.500 1.7913	228000 51200	0.35	1.74	59100 13300	34900 7840	1.69	265000 59700		32311	

<sup>(1)</sup>Based on 1 x 10<sup>6</sup> revolutions L<sub>10</sub> life, for the ISO life-calculation method.

<sup>(2)</sup>Consult your Timken engineer for instructions on use or review the Timken Engineering Manual on timken.com/catalogs.

<sup>(3)</sup>Based on 90 x 10<sup>6</sup> revolutions L<sub>10</sub> life, for The Timken Company life-calculation method. C<sub>90</sub> and C<sub>a90</sub> are radial and thrust values.

Bearing Dimensions											Geometry Factors			Bearing Weight
Width B	Width C	Eff. Ctr. a <sup>(4)</sup>	Shaft			Housing			Cage		G <sub>1</sub>	G <sub>2</sub>	C <sub>g</sub>	
			Max Shaft Fillet Radius R <sup>(5)</sup>	Backing Shoulder Dia. d <sub>a</sub> d <sub>b</sub>		Max Housing Fillet Radius r <sup>(5)</sup>	Backing Shoulder Dia. D <sub>a</sub> D <sub>b</sub>		A <sub>a</sub> <sup>(6)</sup>	A <sub>b</sub> <sup>(7)</sup>				
mm in.	mm in.	mm in.	mm in.	mm in.	mm in.	mm in.	mm in.	mm in.	mm in.	mm in.			kg lbs.	
27.000 1.0630	19.000 0.7480	5.6 0.22	2.5 0.10	63.0 2.48	75.0 2.95	2.0 0.08	104.5 4.11	93.0 3.66	4.8 0.19	4.2 0.17	37.1	14.7	0.0734	1.21 2.67
27.000 1.0630	23.000 0.9055	-6.1 -0.24	2.5 0.10	58.0 2.28	62.0 2.44	2.0 0.08	103.0 4.06	98.0 3.86	1.9 0.07	3.2 0.13	48.7	16.7	0.0892	1.25 2.77
40.000 1.5748	33.000 1.2992	-14.2 -0.56	2.5 0.10	60.0 2.36	65.0 2.56	2.0 0.08	103.0 4.06	95.0 3.74	4.5 0.18	2.9 0.12	60.6	16.0	0.0965	1.83 4.03
40.000 1.5748	33.000 1.2992	-8.6 -0.34	2.5 0.10	60.0 2.36	71.0 2.80	2.0 0.08	103.0 4.06	93.0 3.66	4.3 0.17	3.3 0.13	62.7	17.9	0.0783	1.94 4.27
23.000 0.9055	18.500 0.7283	-2.8 -0.11	1.5 0.06	62.0 2.44	65.0 2.56	0.5 0.02	86.0 3.39	82.0 3.23	0.5 0.02	2.0 0.08	45.6	20.4	0.0925	0.55 1.21
23.000 0.9055	17.500 0.6890	-3.0 -0.12	1.5 0.06	62.0 2.44	65.0 2.56	1.5 0.06	86.5 3.41	82.0 3.23	1.7 0.06	2.1 0.08	46.0	28.0	0.0931	0.56 1.25
27.000 1.0630	21.000 0.8268	-7.9 -0.31	1.5 0.06	61.0 2.40	63.0 2.48	1.5 0.06	87.0 3.43	82.0 3.23	2.3 0.09	1.9 0.08	56.5	27.9	0.0915	0.66 1.46
29.000 1.1417	23.500 0.9252	-7.6 -0.30	1.5 0.06	62.0 2.44	64.0 2.52	2.5 0.10	91.0 3.58	85.0 3.35	0.8 0.03	3.0 0.12	56.4	19.9	0.0937	0.84 1.84
30.000 1.1811	23.000 0.9055	-7.6 -0.30	1.5 0.06	61.0 2.40	67.0 2.64	1.5 0.06	91.0 3.58	85.0 3.35	1.8 0.07	3.3 0.13	52.1	20.1	0.0946	0.84 1.86
21.000 0.8268	18.000 0.7087	-1.8 -0.07	2.0 0.08	64.0 2.52	67.0 2.64	1.5 0.06	95.0 3.74	91.0 3.58	1.5 0.06	3.6 0.14	41.9	22.8	0.0897	0.72 1.58
25.000 0.9843	21.000 0.8268	-4.1 -0.16	2.0 0.08	62.0 2.44	65.0 2.56	1.5 0.06	95.0 3.74	90.0 3.54	1.5 0.06	3.6 0.14	46.1	18.3	0.0928	0.84 1.84
35.000 1.3780	27.000 1.0630	-9.7 -0.38	2.0 0.08	62.0 2.44	68.0 2.68	1.5 0.06	96.0 3.78	89.0 3.50	2.8 0.11	2.8 0.11	59.3	17.2	0.1010	1.16 2.55
39.000 1.5354	32.000 1.2598	-11.7 -0.46	3.0 0.12	64.0 2.52	71.0 2.80	2.5 0.10	104.0 4.09	97.0 3.82	0.3 0.01	3.8 0.15	72.0	16.9	0.0706	1.68 3.71
31.000 1.2205	23.500 0.9252	5.8 0.23	3.0 0.12	66.0 2.59	78.0 3.07	3.0 0.12	109.0 4.29	95.0 3.74	4.3 0.17	4.3 0.17	51.1	15.8	0.0831	1.57 3.46
29.000 1.1417	25.000 0.9843	-6.6 -0.26	2.5 0.10	70.0 2.76	71.0 2.80	2.0 0.08	113.0 4.45	108.0 4.25	2.0 0.08	2.6 0.11	62.8	24.0	0.0947	1.63 3.58
29.000 1.1417	21.000 0.8268	6.9 0.27	2.5 0.10	68.0 2.68	82.0 3.23	2.0 0.08	115.0 4.53	103.0 4.06	4.3 0.17	3.8 0.15	45.5	20.0	0.0785	1.57 3.45
43.000 1.6929	35.000 1.3780	-15.2 -0.60	2.5 0.10	66.0 2.60	70.0 2.76	2.0 0.08	112.0 4.41	105.0 4.13	5.6 0.22	3.4 0.14	77.5	18.5	0.0720	2.32 5.14

<sup>(4)</sup>Negative value indicates effective center inside cone (inner-ring) backface.

<sup>(5)</sup>These maximum fillet radii will be cleared by the bearing corners.

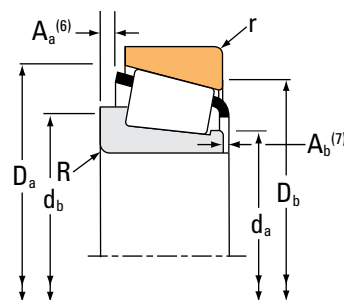
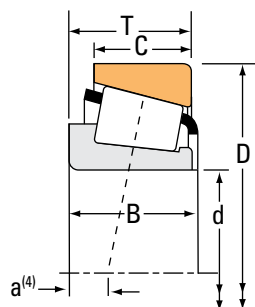
<sup>(6)</sup>Negative value indicates cage extends beyond cone (inner-ring) backface.

<sup>(7)</sup>Negative value indicates cage that does not extend beyond cone (inner-ring) front face.

Continued on next page.

# TAPERED ROLLER BEARINGS

SINGLE-ROW • Metric



Bearing Dimensions			Load Ratings							Part Number	
Bore d	O.D. D	Width T	Dynamic <sup>(1)</sup>		Factors <sup>(2)</sup>		Dynamic <sup>(3)</sup>		Factors <sup>(2)</sup>	Static C <sub>0</sub>	Assembly Inner/Outer
			C <sub>1</sub>	e	Y	C <sub>90</sub>	C <sub>a90</sub>	K			
mm in.	mm in.	mm in.	N lbf			N lbf	N lbf		N lbf		
55.000 2.1654	120.000 4.7244	45.500 1.7913	223000 50100	0.55	1.10	57700 13000	54000 12100	1.07	286000 64300	32311B	
60.000 2.3622	95.000 3.7402	23.000 0.9055	96700 21700	0.43	1.39	25100 5640	18500 4150	1.36	132000 29600	32012X	
60.000 2.3622	95.000 3.7402	24.000 0.9449	97600 21900	0.40	1.49	25300 5690	17400 3910	1.45	135000 30400	JLM508748/JLM508710	
60.000 2.3622	95.000 3.7402	27.000 1.0630	103000 23100	0.33	1.83	26600 5980	14900 3360	1.78	150000 33600	33012	
60.000 2.3622	100.000 3.9370	21.000 0.8268	87300 19600	0.47	1.27	22600 5090	18300 4120	1.24	101000 22800	JP6049/JP6010	
60.000 2.3622	100.000 3.9370	30.000 1.1811	137000 30700	0.40	1.51	35400 7970	24100 5420	1.47	180000 40500	33112	
60.000 2.3622	110.000 4.3307	23.750 0.9350	107000 24100	0.40	1.48	27700 6240	19200 4320	1.44	117000 26200	30212	
60.000 2.3622	110.000 4.3307	29.750 1.1712	149000 33400	0.40	1.48	38600 8680	26800 6020	1.44	178000 40100	32212	
60.000 2.3622	110.000 4.3307	38.000 1.4961	198000 44400	0.40	1.48	51200 11500	35500 7970	1.44	253000 56800	33212	
60.000 2.3622	110.000 4.3307	38.000 1.4961	198000 44400	0.40	1.48	51200 11500	35500 7970	1.44	253000 56800	XAB33212/Y33212	
60.000 2.3622	115.000 4.5276	40.000 1.5748	231000 51900	0.33	1.80	59900 13500	34100 7660	1.76	279000 62800	JF6049/JF6010	
60.000 2.3622	125.000 4.9213	37.000 1.4567	172000 38600	0.82	0.73	44500 10000	62500 14000	0.71	210000 47100	JW6049/JW6010	
60.000 2.3622	130.000 5.1181	33.500 1.3189	201000 45300	0.35	1.74	52200 11700	30800 6930	1.69	221000 49800	30312	
60.000 2.3622	130.000 5.1181	33.500 1.3189	171000 38500	0.83	0.73	44400 9990	62800 14100	0.71	188000 42200	31312	
60.000 2.3622	130.000 5.1181	48.500 1.9094	264000 59400	0.35	1.74	68500 15400	40400 9090	1.69	310000 69800	32312	
60.000 2.3622	130.000 5.1181	48.500 1.9094	264000 59400	0.55	1.10	68500 15400	64100 14400	1.07	343000 77000	32312B	
65.000 2.5591	100.000 3.9370	23.000 0.9055	98000 22000	0.46	1.31	25400 5710	20000 4490	1.27	137000 30900	32013X	

<sup>(1)</sup>Based on 1 x 10<sup>6</sup> revolutions L<sub>10</sub> life, for the ISO life-calculation method.

<sup>(2)</sup>Consult your Timken engineer for instructions on use or review the Timken Engineering Manual on timken.com/catalogs.

<sup>(3)</sup>Based on 90 x 10<sup>6</sup> revolutions L<sub>10</sub> life, for The Timken Company life-calculation method. C<sub>90</sub> and C<sub>a90</sub> are radial and thrust values.

Bearing Dimensions											Geometry Factors			Bearing Weight
Width B	Width C	Eff. Ctr. a <sup>(4)</sup>	Shaft			Housing			Cage		G <sub>1</sub>	G <sub>2</sub>	C <sub>g</sub>	
			Max Shaft Fillet Radius R <sup>(5)</sup>	Backing Shoulder Dia. d <sub>a</sub> d <sub>b</sub>		Max Housing Fillet Radius r <sup>(5)</sup>	Backing Shoulder Dia. D <sub>a</sub> D <sub>b</sub>		A <sub>a</sub> <sup>(6)</sup>	A <sub>b</sub> <sup>(7)</sup>				
mm in.	mm in.	mm in.	mm in.	mm in.	mm in.	mm in.	mm in.	mm in.	mm in.	mm in.			kg lbs.	
43.000 1.6929	35.000 1.3780	-8.6 -0.34	2.5 0.10	66.0 2.60	82.0 3.23	2.0 0.08	114.0 4.49	101.0 3.98	4.5 0.17	3.6 0.14	78.8	24.6	0.0844	2.45 5.40
23.000 0.9055	17.500 0.6890	-1.8 -0.07	1.5 0.06	66.0 2.60	68.0 2.68	1.5 0.06	91.0 3.58	86.0 3.39	1.8 0.07	2.1 0.08	51.2	31.4	0.0982	0.60 1.32
24.000 0.9449	19.000 0.7480	-2.8 -0.11	5.0 0.20	66.0 2.60	75.0 2.95	2.5 0.10	91.0 3.58	85.0 3.35	1.0 0.04	2.0 0.08	54.2	27.5	0.0979	0.60 1.33
27.000 1.0630	21.000 0.8268	-7.1 -0.28	1.5 0.06	65.0 2.56	69.0 2.72	1.5 0.06	91.0 3.58	86.0 3.39	2.4 0.09	1.9 0.08	63.0	31.1	0.0964	0.69 1.53
20.000 0.7874	15.500 0.6102	1.3 0.05	2.0 0.08	66.0 2.60	69.0 2.72	2.0 0.08	95.5 3.76	91.0 3.58	0.8 0.03	3.6 0.14	39.5	22.5	0.0922	0.59 1.31
30.000 1.1811	23.000 0.9055	-6.4 -0.25	1.5 0.06	67.0 2.64	72.0 2.83	1.5 0.06	96.0 3.78	90.0 3.54	2.4 0.09	2.5 0.10	61.7	23.9	0.1021	0.92 2.00
22.000 0.8661	19.000 0.7480	-1.8 -0.07	2.0 0.08	66.0 2.60	70.0 2.76	1.5 0.06	103.0 4.06	99.0 3.90	1.4 0.05	3.6 0.14	44.1	19.5	0.0909	0.88 1.96
28.000 1.1024	24.000 0.9449	-5.1 -0.20	2.0 0.08	67.0 2.64	71.0 2.80	1.5 0.06	104.0 4.09	98.0 3.86	0.5 0.02	3.3 0.13	59.3	21.1	0.0911	1.16 2.57
38.000 1.4961	29.000 1.1417	-9.9 -0.39	2.0 0.08	68.0 2.68	74.0 2.91	1.5 0.06	105.0 4.13	98.0 3.86	3.9 0.15	2.5 0.10	76.2	20.0	0.0758	1.53 3.37
38.000 1.4961	29.000 1.1417	-9.9 -0.39	5.0 0.20	68.0 2.68	83.0 3.27	1.5 0.06	105.0 4.13	98.0 3.86	3.9 0.15	2.5 0.10	76.2	20.0	0.0758	1.53 3.37
39.000 1.5354	33.000 1.2992	-11.9 -0.47	2.5 0.10	68.0 2.68	76.0 2.99	2.5 0.10	109.0 4.29	103.0 4.06	0.8 0.03	4.1 0.16	81.9	20.3	0.0726	1.86 4.11
33.500 1.3189	26.000 1.0236	4.8 0.19	3.0 0.12	72.0 2.83	89.0 3.50	3.0 0.12	119.0 4.69	104.0 4.09	4.8 0.19	4.8 0.19	64.1	18.6	0.0883	2.02 4.46
31.000 1.2205	26.000 1.0236	-7.1 -0.28	3.0 0.12	69.0 2.72	74.0 2.91	2.5 0.10	121.0 4.76	116.0 4.57	2.5 0.10	4.0 0.16	75.8	22.2	0.0710	1.96 4.32
31.000 1.2205	22.000 0.8661	7.6 0.30	3.0 0.12	74.0 2.91	89.0 3.50	2.5 0.10	123.0 4.84	111.0 4.37	5.5 0.21	4.2 0.17	56.2	23.5	0.0842	1.97 4.35
46.000 1.8110	37.000 1.4567	-16.5 -0.65	3.0 0.12	72.0 2.83	78.0 3.07	2.5 0.10	121.0 4.76	113.0 4.45	6.9 0.27	3.4 0.14	94.1	21.2	0.0768	2.89 6.35
46.000 1.8110	37.000 1.4567	-9.7 -0.38	3.0 0.12	72.0 2.83	90.0 3.54	2.5 0.10	122.0 4.80	110.0 4.33	5.5 0.21	4.2 0.17	95.9	23.6	0.0901	3.07 6.74
23.000 0.9055	17.500 0.6890	-0.3 -0.01	1.5 0.06	71.0 2.80	73.0 2.87	1.5 0.06	97.0 3.82	91.0 3.58	1.9 0.07	2.0 0.08	57.4	35.6	0.1039	0.64 1.40

<sup>(4)</sup>Negative value indicates effective center inside cone (inner-ring) backface.

<sup>(5)</sup>These maximum fillet radii will be cleared by the bearing corners.

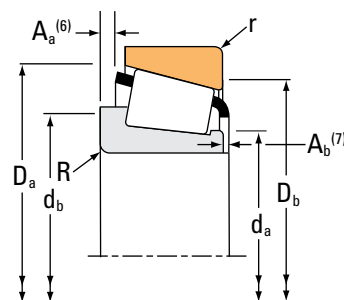
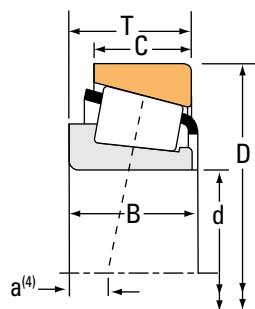
<sup>(6)</sup>Negative value indicates cage extends beyond cone (inner-ring) backface.

<sup>(7)</sup>Negative value indicates cage that does not extend beyond cone (inner-ring) front face.

Continued on next page.

# TAPERED ROLLER BEARINGS

SINGLE-ROW • Metric



Bearing Dimensions			Load Ratings							Part Number	
Bore d	O.D. D	Width T	Dynamic <sup>(1)</sup>		Factors <sup>(2)</sup>		Dynamic <sup>(3)</sup>		Factors <sup>(2)</sup>	Static C <sub>0</sub>	Assembly Inner/Outer
			C <sub>1</sub>	e	Y	C <sub>90</sub>	C <sub>a90</sub>	K	C <sub>0</sub>		
mm in.	mm in.	mm in.	N lbf			N lbf	N lbf		N lbf		
65.000 2.5591	100.000 3.9370	27.000 1.0630	107000 24100	0.35	1.72	27800 6240	16600 3720	1.68	162000 36400	33013	
65.000 2.5591	105.000 4.1339	24.000 0.9449	108000 24300	0.45	1.32	28000 6310	21800 4900	1.29	139000 31300	JLM710949C/JLM710910	
65.000 2.5591	110.000 4.3307	28.000 1.1024	141000 31700	0.40	1.49	36600 8220	25200 5660	1.45	195000 43900	JM511946/JM511910	
65.000 2.5591	110.000 4.3307	31.000 1.2205	163000 36600	0.33	1.81	42200 9490	23900 5380	1.76	212000 47700	JD6549/JD6510	
65.000 2.5591	110.000 4.3307	34.000 1.3386	167000 37500	0.39	1.55	43300 9730	28700 6460	1.51	225000 50600	33113	
65.000 2.5591	120.000 4.7244	24.750 0.9744	138000 31100	0.40	1.48	35900 8070	24900 5600	1.44	158000 35500	30213	
65.000 2.5591	120.000 4.7244	32.750 1.2894	174000 39100	0.40	1.48	45100 10100	31200 7030	1.44	209000 46900	32213	
65.000 2.5591	120.000 4.7244	39.000 1.5354	223000 50100	0.34	1.78	57800 13000	33400 7500	1.73	283000 63600	JH211749/JH211710	
65.000 2.5591	120.000 4.7244	41.000 1.6142	221000 49700	0.39	1.54	57300 12900	38300 8600	1.50	280000 62900	33213	
65.000 2.5591	130.000 5.1181	37.000 1.4567	175000 39400	0.87	0.69	45500 10200	67400 15200	0.67	220000 49400	JW6549/JW6510	
65.000 2.5591	140.000 5.5118	36.000 1.4173	196000 44100	0.83	0.73	50800 11400	71800 16100	0.71	217000 48700	31313	
65.000 2.5591	140.000 5.5118	36.000 1.4173	222000 50000	0.35	1.74	57600 13000	34000 7650	1.69	242000 54400	30313	
65.000 2.5591	140.000 5.5118	51.000 2.0078	320000 72000	0.35	1.74	83000 18700	49000 11000	1.69	388000 87200	32313	
70.000 2.7559	110.000 4.3307	21.000 0.8268	91600 20600	0.46	1.30	23700 5340	18700 4210	1.27	112000 25200	JP7049/JP7010	
70.000 2.7559	110.000 4.3307	25.000 0.9843	112000 25200	0.43	1.38	29100 6550	21700 4870	1.34	163000 36700	32014X	
70.000 2.7559	110.000 4.3307	26.000 1.0236	115000 25700	0.49	1.23	29700 6680	24800 5570	1.20	168000 37800	JLM813049/JLM813010	
70.000 2.7559	110.000 4.3307	31.000 1.2205	153000 34500	0.28	2.11	39800 8940	19400 4360	2.05	236000 53000	33014	

<sup>(1)</sup>Based on 1 x 10<sup>6</sup> revolutions L<sub>10</sub> life, for the ISO life-calculation method.

<sup>(2)</sup>Consult your Timken engineer for instructions on use or review the Timken Engineering Manual on timken.com/catalogs.

<sup>(3)</sup>Based on 90 x 10<sup>6</sup> revolutions L<sub>10</sub> life, for The Timken Company life-calculation method. C<sub>90</sub> and C<sub>a90</sub> are radial and thrust values.



Bearing Dimensions											Geometry Factors			Bearing Weight
Width B	Width C	Eff. Ctr. a <sup>(4)</sup>	Shaft			Housing			Cage		G <sub>1</sub>	G <sub>2</sub>	C <sub>g</sub>	
			Max Shaft Fillet Radius R <sup>(5)</sup>	Backing Shoulder Dia. d <sub>a</sub> d <sub>b</sub>		Max Housing Fillet Radius r <sup>(5)</sup>	Backing Shoulder Dia. D <sub>a</sub> D <sub>b</sub>		A <sub>a</sub> <sup>(6)</sup>	A <sub>b</sub> <sup>(7)</sup>				
mm in.	mm in.	mm in.	mm in.	mm in.	mm in.	mm in.	mm in.	mm in.	mm in.	mm in.			kg lbs.	
27.000 1.0630	21.000 0.8268	-6.1 -0.24	1.5 0.06	70.0 2.76	74.0 2.91	1.5 0.06	96.0 3.78	91.0 3.58	2.5 0.10	2.0 0.08	72.4	36.1	0.1029	0.74 1.64
23.000 0.9055	18.500 0.7283	-0.3 -0.01	3.0 0.12	72.0 2.83	78.0 3.07	1.0 0.04	100.5 3.96	96.0 3.78	1.0 0.04	3.6 0.14	55.5	24.5	0.1020	0.75 1.66
28.000 1.1024	22.500 0.8858	-3.3 -0.13	3.0 0.12	72.0 2.83	78.0 3.07	2.5 0.10	105.0 4.13	99.0 3.90	0.3 0.01	2.8 0.11	76.3	23.6	0.1100	1.06 2.34
31.000 1.2205	25.000 0.9843	-7.6 -0.30	2.0 0.08	73.0 2.87	76.0 2.99	2.0 0.08	105.0 4.13	99.0 3.90	0.3 0.01	3.8 0.15	78.1	27.3	0.1040	1.17 2.59
34.000 1.3386	26.500 1.0433	-7.9 -0.31	1.5 0.06	73.0 2.87	77.0 3.03	1.5 0.06	106.0 4.17	99.0 3.90	2.4 0.09	2.5 0.10	80.1	24.5	0.1105	1.27 2.78
23.000 0.9055	20.000 0.7874	-1.5 -0.06	2.0 0.08	74.0 2.91	77.0 3.03	1.5 0.06	113.5 4.47	110.0 4.33	2.0 0.08	4.6 0.19	60.4	27.5	0.0694	1.14 2.52
31.000 1.2205	27.000 1.0630	-5.6 -0.22	2.0 0.08	73.0 2.87	77.0 3.03	1.5 0.06	114.0 4.49	108.0 4.25	3.6 0.14	3.2 0.13	72.9	23.4	0.0742	1.51 3.33
38.500 1.5157	32.000 1.2598	-10.8 -0.42	3.0 0.12	74.0 2.91	80.0 3.15	2.5 0.10	114.0 4.49	107.0 4.21	0.5 0.02	4.1 0.16	94.0	22.5	0.0764	1.89 4.16
41.000 1.6142	32.000 1.2598	-11.2 -0.44	2.0 0.08	74.0 2.91	79.0 3.11	1.5 0.06	115.0 4.53	107.0 4.21	3.4 0.13	2.8 0.11	90.3	21.8	0.0791	1.97 4.35
33.500 1.3189	26.000 1.0236	7.9 0.31	3.0 0.12	76.0 2.99	94.0 3.70	3.0 0.12	124.0 4.88	109.0 4.29	5.1 0.20	4.3 0.17	71.0	18.2	0.0927	2.15 4.74
33.000 1.2992	23.000 0.9055	8.1 0.32	3.0 0.12	80.0 3.15	96.0 3.78	2.5 0.10	132.5 5.22	120.0 4.72	5.7 0.22	5.0 0.20	67.1	22.2	0.0839	2.39 5.27
33.000 1.2992	28.000 1.1024	-7.6 -0.30	3.0 0.12	75.0 2.95	80.0 3.15	2.5 0.10	131.0 5.16	125.0 4.92	2.4 0.09	4.7 0.19	87.4	22.9	0.0743	2.47 5.43
48.000 1.8898	39.000 1.5354	-16.5 -0.65	3.0 0.12	80.0 3.15	88.0 3.46	2.5 0.10	132.0 5.20	124.0 4.88	4.1 0.16	5.6 0.22	119.7	30.9	0.0783	3.62 7.97
20.000 0.7874	15.500 0.6102	2.5 0.10	2.0 0.08	76.0 2.99	80.0 3.15	2.0 0.08	105.4 4.15	101.0 3.98	0.8 0.03	3.6 0.14	51.1	31.0	0.0995	0.67 1.48
25.000 0.9843	19.000 0.7480	-1.0 -0.04	1.5 0.06	76.0 2.99	78.0 3.07	1.5 0.06	105.0 4.13	100.0 3.94	2.3 0.09	1.9 0.08	74.1	44.8	0.1112	0.86 1.91
25.000 0.9843	20.500 0.8071	0.3 0.01	1.0 0.04	77.0 3.03	78.0 3.07	2.5 0.10	105.0 4.13	98.0 3.86	1.3 0.05	3.3 0.13	73.5	26.3	0.1150	0.88 1.93
31.000 1.2205	25.500 1.0039	-8.6 -0.34	1.5 0.06	77.0 3.03	79.0 3.11	1.5 0.06	106.0 4.17	101.0 3.98	0.5 0.02	3.6 0.15	105.3	50.1	0.1092	1.11 2.43

<sup>(4)</sup>Negative value indicates effective center inside cone (inner-ring) backface.

<sup>(5)</sup>These maximum fillet radii will be cleared by the bearing corners.

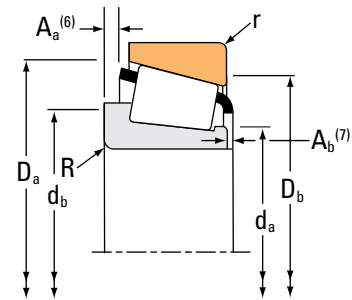
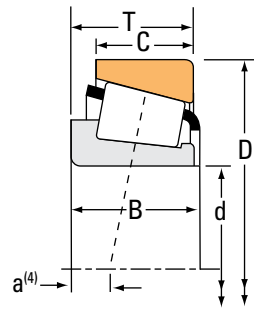
<sup>(6)</sup>Negative value indicates cage extends beyond cone (inner-ring) backface.

<sup>(7)</sup>Negative value indicates cage that does not extend beyond cone (inner-ring) front face.

Continued on next page.

# TAPERED ROLLER BEARINGS

SINGLE-ROW • Metric



Bearing Dimensions			Load Ratings							Part Number	
Bore d	O.D. D	Width T	Dynamic <sup>(1)</sup>		Factors <sup>(2)</sup>		Dynamic <sup>(3)</sup>		Factors <sup>(2)</sup>	Static C <sub>0</sub>	Assembly Inner/Outer
			C <sub>1</sub>	e	Y	C <sub>90</sub>	C <sub>a90</sub>	K			
mm in.	mm in.	mm in.	N lbf			N lbf	N lbf		N lbf		
70.000 2.7559	115.000 4.5276	29.000 1.1417	150000 33700	0.43	1.39	38900 8740	28600 6440	1.36	198000 44500	JM612949/JM612910	
70.000 2.7559	120.000 4.7244	37.000 1.4567	198000 44500	0.38	1.58	51300 11500	33300 7480	1.54	270000 60800	33114	
70.000 2.7559	125.000 4.9213	26.250 1.0335	138000 31000	0.42	1.43	35800 8050	25700 5790	1.39	157000 35300	30214	
70.000 2.7559	125.000 4.9213	33.250 1.3091	182000 41000	0.42	1.43	47300 10600	34000 7640	1.39	224000 50400	32214	
70.000 2.7559	125.000 4.9213	41.000 1.6142	238000 53400	0.41	1.47	61600 13800	43100 9700	1.43	314000 70700	33214	
70.000 2.7559	130.000 5.1181	43.000 1.6929	275000 61700	0.33	1.80	71200 16000	40600 9130	1.75	360000 80800	JF7049/JF7010	
70.000 2.7559	130.000 5.1181	43.000 1.6929	275000 61700	0.33	1.80	71200 16000	40600 9130	1.75	360000 80800	JF7049A/JF7010	
70.000 2.7559	140.000 5.5118	39.000 1.5354	204000 45800	0.87	0.69	52800 11900	78300 17600	0.67	257000 57800	JW7049/JW7010	
70.000 2.7559	150.000 5.9055	38.000 1.4961	213000 47900	0.83	0.73	55200 12400	78000 17500	0.71	235000 52900	31314	
70.000 2.7559	150.000 5.9055	38.000 1.4961	251000 56500	0.35	1.74	65100 14600	38500 8650	1.69	276000 62000	30314	
70.000 2.7559	150.000 5.9055	41.275 1.6250	230000 51700	0.78	0.77	59600 13400	79900 18000	0.75	256000 57500	JH913848/JH913811	
70.000 2.7559	150.000 5.9055	54.000 2.1260	366000 82300	0.35	1.74	94900 21300	56000 12600	1.69	448000 101000	32314	
75.000 2.9528	115.000 4.5276	25.000 0.9842	114000 25600	0.46	1.31	29500 6640	23200 5210	1.27	170000 38200	32015X	
75.000 2.9528	115.000 4.5276	25.000 0.9843	118000 26600	0.46	1.31	30700 6900	24100 5420	1.27	167000 37500	JLM714149/JLM714110	
75.000 2.9528	115.000 4.5276	31.000 1.2205	158000 35400	0.30	2.01	40900 9180	20900 4690	1.96	239000 53700	33015	
75.000 2.9528	120.000 4.7244	31.000 1.2205	159000 35800	0.44	1.35	41300 9290	31400 7070	1.31	229000 51500	JM714249/JM714210	
75.000 2.9528	125.000 4.9213	37.000 1.4567	205000 46000	0.40	1.51	53000 11900	36100 8110	1.47	287000 64500	33115	

<sup>(1)</sup>Based on 1 x 10<sup>6</sup> revolutions L<sub>10</sub> life, for the ISO life-calculation method.

<sup>(2)</sup>Consult your Timken engineer for instructions on use or review the Timken Engineering Manual on timken.com/catalogs.

<sup>(3)</sup>Based on 90 x 10<sup>6</sup> revolutions L<sub>10</sub> life, for The Timken Company life-calculation method. C<sub>90</sub> and C<sub>a90</sub> are radial and thrust values.

Bearing Dimensions											Geometry Factors			Bearing Weight
Width B	Width C	Eff. Ctr. a <sup>(4)</sup>	Shaft			Housing			Cage		G <sub>1</sub>	G <sub>2</sub>	C <sub>g</sub>	
			Max Shaft Fillet Radius R <sup>(5)</sup>	Backing Shoulder Dia. d <sub>a</sub> d <sub>b</sub>		Max Housing Fillet Radius r <sup>(5)</sup>	Backing Shoulder Dia. D <sub>a</sub> D <sub>b</sub>		A <sub>a</sub> <sup>(6)</sup>	A <sub>b</sub> <sup>(7)</sup>				
mm in.	mm in.	mm in.	mm in.	mm in.	mm in.	mm in.	mm in.	mm in.	mm in.	mm in.			kg lbs.	
29.000 1.1417	23.000 0.9055	-2.5 -0.10	3.0 0.12	77.0 3.03	83.0 3.27	2.5 0.10	110.0 4.33	103.0 4.06	0.5 0.02	2.8 0.11	76.7	25.7	0.1010	1.13 2.49
37.000 1.4567	29.000 1.1417	-8.6 -0.34	2.0 0.08	79.0 3.11	85.0 3.35	1.5 0.06	115.0 4.53	108.0 4.25	2.7 0.10	2.4 0.10	99.5	31.6	0.0809	1.69 3.70
24.000 0.9449	21.000 0.8268	-0.5 -0.02	2.0 0.08	77.0 3.03	80.0 3.15	1.5 0.06	118.0 4.65	115.0 4.53	1.8 0.07	3.9 0.15	63.7	24.8	0.0714	1.23 2.73
31.000 1.2205	27.000 1.0630	-4.6 -0.18	2.0 0.08	79.0 3.11	82.0 3.23	1.5 0.06	119.0 4.69	114.0 4.49	3.4 0.13	3.3 0.13	81.4	25.6	0.0779	1.63 3.59
41.000 1.6142	32.000 1.2598	-9.9 -0.39	2.0 0.08	79.0 3.11	85.0 3.35	1.5 0.06	120.0 4.72	112.0 4.41	3.6 0.14	3.6 0.14	104.5	25.6	0.0794	2.10 4.63
42.000 1.6535	35.000 1.3780	-12.4 -0.49	3.0 0.12	81.0 3.17	86.0 3.39	2.5 0.10	124.0 4.88	116.0 4.57	1.5 0.06	4.6 0.18	120.7	24.5	0.0828	2.49 5.49
42.000 1.6535	35.000 1.3780	-12.4 -0.49	7.0 0.28	81.0 3.17	94.0 3.70	2.5 0.10	124.0 4.88	116.0 4.57	1.5 0.06	4.6 0.18	120.7	24.5	0.0828	2.45 5.40
35.500 1.3976	27.000 1.0630	8.6 0.34	3.0 0.12	82.0 3.23	95.0 3.74	3.0 0.12	133.0 5.25	117.0 4.61	4.3 0.17	5.3 0.21	85.2	23.4	0.0984	2.63 5.79
35.000 1.3780	25.000 0.9843	9.1 0.36	3.0 0.12	85.0 3.35	101.0 3.98	2.5 0.10	141.5 5.57	129.0 5.08	5.9 0.23	4.8 0.19	75.8	29.5	0.0873	2.92 6.46
35.000 1.3780	30.000 1.1811	-8.1 -0.32	3.0 0.12	83.0 3.27	88.0 3.46	2.5 0.10	139.5 5.49	135.0 5.31	3.1 0.12	4.9 0.20	102.4	27.4	0.0737	2.97 6.53
39.688 1.5625	25.400 1.0000	4.3 0.17	2.0 0.08	82.3 3.24	92.0 3.62	3.3 0.13	146.0 5.75	126.0 4.96	7.4 0.29	4.6 0.18	78.5	17.3	0.0927	3.05 6.73
51.000 2.0079	42.000 1.6535	-16.8 -0.66	3.0 0.12	86.0 3.39	94.0 3.70	2.5 0.10	141.0 5.55	133.0 5.24	4.0 0.15	4.9 0.20	141.9	33.1	0.0828	4.39 9.69
25.000 0.9843	19.000 0.7480	0.5 0.02	1.5 0.06	82.0 3.23	84.0 3.31	1.5 0.06	110.0 4.33	105.0 4.13	2.4 0.09	1.9 0.08	81.8	49.9	0.1166	0.91 2.01
25.000 0.9843	19.000 0.7480	0.5 0.02	3.0 0.12	81.0 3.19	87.0 3.43	2.5 0.10	110.0 4.33	104.0 4.09	1.5 0.06	2.8 0.11	76.3	33.7	0.1030	0.88 1.93
31.000 1.2205	25.500 1.0039	-7.6 -0.30	1.5 0.06	83.0 3.27	90.0 3.54	1.5 0.06	110.0 4.33	104.0 4.09	1.5 0.05	2.5 0.10	109.4	47.2	0.1122	1.15 2.54
29.500 1.1614	25.000 0.9843	-2.0 -0.08	3.0 0.12	82.9 3.26	88.0 3.46	2.5 0.10	115.0 4.53	108.0 4.25	1.5 0.06	3.3 0.13	95.0	32.8	0.1220	1.28 2.81
37.000 1.4567	29.000 1.1417	-7.4 -0.29	2.0 0.08	83.0 3.27	88.0 3.46	1.5 0.06	120.0 4.72	112.0 4.41	2.8 0.11	2.4 0.10	110.7	26.3	0.0851	1.76 3.87

<sup>(4)</sup>Negative value indicates effective center inside cone (inner-ring) backface.

<sup>(5)</sup>These maximum fillet radii will be cleared by the bearing corners.

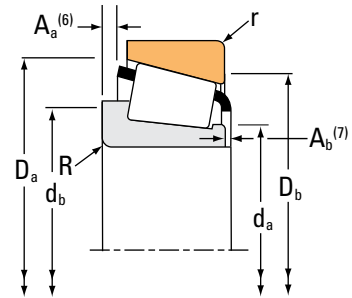
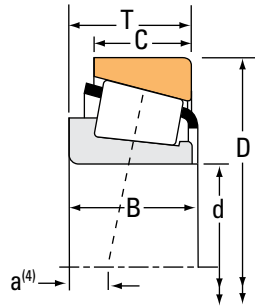
<sup>(6)</sup>Negative value indicates cage extends beyond cone (inner-ring) backface.

<sup>(7)</sup>Negative value indicates cage that does not extend beyond cone (inner-ring) front face.

Continued on next page.

# TAPERED ROLLER BEARINGS

SINGLE-ROW • Metric



Bearing Dimensions			Load Ratings							Part Number	
Bore d	O.D. D	Width T	Dynamic <sup>(1)</sup>		Factors <sup>(2)</sup>		Dynamic <sup>(3)</sup>		Factors <sup>(2)</sup>	Static C <sub>0</sub>	Assembly Inner/Outer
			C <sub>1</sub>	e	Y	C <sub>90</sub>	C <sub>a90</sub>	K			
mm in.	mm in.	mm in.	N lbf			N lbf	N lbf		N lbf		
75.000 2.9528	130.000 5.1181	27.250 1.0728	158000 35500	0.44	1.38	40900 9200	30500 6850	1.34	189000 42500	30215	
75.000 2.9528	130.000 5.1181	33.250 1.3091	184000 41300	0.44	1.38	47700 10700	35500 7980	1.34	227000 51100	32215	
75.000 2.9528	130.000 5.1181	41.000 1.6142	236000 53100	0.43	1.40	61200 13800	44900 10100	1.37	316000 71000	33215	
75.000 2.9528	145.000 5.7087	51.000 2.0079	347000 78000	0.36	1.66	89900 20200	55700 12500	1.61	463000 104000	JH415647/JH415610	
75.000 2.9528	150.000 5.9055	42.000 1.6535	231000 52000	0.87	0.69	59900 13500	88900 20000	0.67	294000 66200	JW7549/JW7510	
75.000 2.9528	160.000 6.2992	40.000 1.5748	248000 55800	0.83	0.73	64400 14500	90900 20400	0.71	278000 62500	31315	
75.000 2.9528	160.000 6.2992	40.000 1.5748	299000 67200	0.35	1.74	77500 17400	45800 10300	1.69	338000 76000	30315	
75.000 2.9528	160.000 6.2992	58.000 2.2835	357000 80300	0.35	1.74	92600 20800	54700 12300	1.69	421000 94600	32315	
80.000 3.1496	125.000 4.9213	29.000 1.1417	166000 37300	0.42	1.42	43000 9670	31200 7010	1.38	238000 53600	32016X	
80.000 3.1496	125.000 4.9213	36.000 1.4173	210000 47100	0.28	2.16	54300 12200	25900 5820	2.10	315000 70900	33016	
80.000 3.1496	130.000 5.1181	35.000 1.3780	199000 44700	0.39	1.54	51500 11600	34200 7700	1.50	283000 63500	JM515649/JM515610	
80.000 3.1496	130.000 5.1181	37.000 1.4567	209000 47100	0.42	1.44	54100 12200	38500 8660	1.40	300000 67300	33116	
80.000 3.1496	130.000 5.1181	37.000 1.4567	209000 47100	0.42	1.44	54100 12200	38500 8660	1.40	300000 67300	XA33116/Y33116	
80.000 3.1496	140.000 5.5118	28.250 1.1122	164000 36800	0.42	1.43	42400 9530	30500 6860	1.39	187000 42000	30216	
80.000 3.1496	140.000 5.5118	35.250 1.3878	206000 46200	0.42	1.43	53300 12000	38300 8620	1.39	249000 56000	32216	
80.000 3.1496	140.000 5.5118	46.000 1.8110	297000 66700	0.43	1.41	76900 17300	56000 12600	1.37	409000 91900	33216	
80.000 3.1496	160.000 6.2992	45.000 1.7717	264000 59300	0.87	0.69	68400 15400	101000 22800	0.67	339000 76100	JW8049/JW8010	

<sup>(1)</sup>Based on 1 x 10<sup>6</sup> revolutions L<sub>10</sub> life, for the ISO life-calculation method.

<sup>(2)</sup>Consult your Timken engineer for instructions on use or review the Timken Engineering Manual on timken.com/catalogs.

<sup>(3)</sup>Based on 90 x 10<sup>6</sup> revolutions L<sub>10</sub> life, for The Timken Company life-calculation method. C<sub>90</sub> and C<sub>a90</sub> are radial and thrust values.

Bearing Dimensions											Geometry Factors			Bearing Weight
Width B	Width C	Eff. Ctr. a <sup>(4)</sup>	Shaft			Housing			Cage		G <sub>1</sub>	G <sub>2</sub>	C <sub>g</sub>	
			Max Shaft Fillet Radius R <sup>(5)</sup>	Backing Shoulder Dia. d <sub>a</sub> d <sub>b</sub>		Max Housing Fillet Radius r <sup>(5)</sup>	Backing Shoulder Dia. D <sub>a</sub> D <sub>b</sub>		A <sub>a</sub> <sup>(6)</sup>	A <sub>b</sub> <sup>(7)</sup>				
mm in.	mm in.	mm in.	mm in.	mm in.	mm in.	mm in.	mm in.	mm in.	mm in.	mm in.			kg lbs.	
25.000 0.9843	22.000 0.8661	0.0 0.00	2.0 0.08	85.0 3.35	88.0 3.46	1.5 0.06	124.0 4.88	120.0 4.72	2.0 0.08	3.8 0.15	74.3	23.5	0.0761	1.35 2.97
31.000 1.2205	27.000 1.0630	-3.6 -0.14	2.0 0.08	84.0 3.31	88.0 3.46	1.5 0.06	125.0 4.92	117.0 4.61	3.5 0.13	3.4 0.14	87.5	26.9	0.0806	1.69 3.72
41.000 1.6142	31.000 1.2205	-8.6 -0.34	2.0 0.08	83.0 3.27	89.0 3.50	1.5 0.06	125.0 4.92	117.0 4.61	4.2 0.16	2.8 0.11	111.4	27.0	0.0874	2.17 4.77
51.000 2.0079	42.000 1.6535	-14.2 -0.56	3.0 0.12	89.0 3.50	94.0 3.70	2.5 0.10	139.0 5.47	129.0 5.08	1.5 0.06	3.8 0.15	158.3	26.4	0.0931	3.82 8.42
38.000 1.4961	29.000 1.1417	9.4 0.37	3.0 0.12	88.0 3.46	107.0 4.21	1.1 0.05	142.0 5.59	126.0 4.96	5.6 0.22	5.3 0.21	100.3	24.2	0.1040	3.23 7.11
37.000 1.4567	26.000 1.0236	10.2 0.40	3.0 0.12	91.0 3.58	108.0 4.25	2.5 0.10	151.5 5.96	138.0 5.43	6.9 0.27	5.0 0.20	91.5	21.4	0.0930	3.46 7.63
37.000 1.4567	31.000 1.2205	-8.1 -0.32	3.0 0.12	89.0 3.50	94.0 3.70	2.5 0.10	149.0 5.87	145.0 5.71	2.7 0.10	5.7 0.23	126.6	26.7	0.0841	3.65 8.05
55.000 2.1654	45.000 1.7717	-17.3 -0.68	3.0 0.12	93.0 3.66	97.0 3.82	2.5 0.10	149.0 5.87	141.0 5.55	6.6 0.26	1.5 0.06	145.2	26.7	0.0831	5.06 11.15
29.000 1.1417	22.000 0.8661	-1.8 -0.07	1.5 0.06	87.0 3.43	91.0 3.58	1.5 0.06	120.0 4.72	114.0 4.49	2.8 0.11	2.4 0.10	104.0	36.3	0.1234	1.27 2.80
36.000 1.4173	29.500 1.1614	-10.2 -0.40	1.5 0.06	88.0 3.46	90.0 3.54	1.5 0.06	120.0 4.72	115.0 4.53	0.8 0.03	3.6 0.14	139.4	49.4	0.0769	1.61 3.56
34.000 1.3386	28.500 1.1220	-5.1 -0.20	3.0 0.12	88.0 3.46	94.0 3.70	2.5 0.10	125.0 4.92	117.0 4.61	1.0 0.04	3.3 0.13	118.5	31.1	0.0863	1.71 3.77
37.000 1.4567	29.000 1.1417	-6.1 -0.24	2.0 0.08	89.0 3.50	94.0 3.70	1.5 0.06	125.0 4.92	119.0 4.69	3.4 0.13	2.5 0.10	121.6	37.9	0.0891	1.86 4.10
37.000 1.4567	29.000 1.1417	-6.1 -0.24	2.0 0.08	89.0 3.50	94.0 3.70	1.5 0.06	125.0 4.92	119.0 4.69	3.4 0.13	2.5 0.10	121.6	37.9	0.0838	1.85 4.10
26.000 1.0236	22.000 0.8661	0.0 0.00	2.5 0.10	89.0 3.50	93.0 3.66	2.0 0.08	133.0 5.24	127.0 5.00	1.8 0.07	3.6 0.14	80.7	28.4	0.0771	1.63 3.58
33.000 1.2992	28.000 1.1024	-4.6 -0.18	2.5 0.10	91.0 3.58	96.0 3.78	2.0 0.08	134.0 5.28	128.0 5.04	3.8 0.15	4.1 0.16	98.4	28.7	0.0828	2.07 4.55
46.000 1.8110	35.000 1.3780	-10.7 -0.42	2.5 0.10	89.0 3.50	97.0 3.82	2.0 0.08	135.0 5.31	125.0 4.92	5.3 0.21	2.9 0.12	142.7	38.0	0.0948	2.95 6.49
41.000 1.6142	31.000 1.2205	9.7 0.38	3.0 0.12	93.0 3.67	108.0 4.25	3.0 0.12	152.0 5.98	134.0 5.28	5.8 0.23	5.3 0.21	117.3	27.2	0.1090	4.04 8.90

<sup>(4)</sup>Negative value indicates effective center inside cone (inner-ring) backface.

<sup>(5)</sup>These maximum fillet radii will be cleared by the bearing corners.

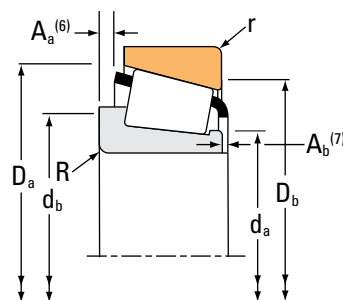
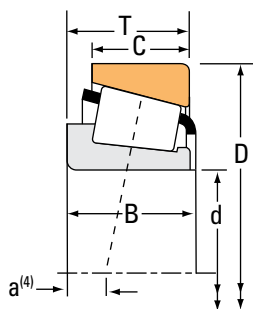
<sup>(6)</sup>Negative value indicates cage extends beyond cone (inner-ring) backface.

<sup>(7)</sup>Negative value indicates cage that does not extend beyond cone (inner-ring) front face.

Continued on next page.

# TAPERED ROLLER BEARINGS

SINGLE-ROW • Metric



Bearing Dimensions			Load Ratings							Part Number	
Bore d	O.D. D	Width T	Dynamic <sup>(1)</sup>		Factors <sup>(2)</sup>		Dynamic <sup>(3)</sup>		Factors <sup>(2)</sup>	Static C <sub>0</sub>	Assembly Inner/Outer
			C <sub>1</sub>	e	Y	C <sub>90</sub>	C <sub>a90</sub>	K			
mm in.	mm in.	mm in.	N lbf			N lbf	N lbf		N lbf		
80.000 3.1496	170.000 6.6929	42.500 1.6732	271000 60900	0.83	0.73	70200 15800	99100 22300	0.71	312000 70100	31316	
80.000 3.1496	170.000 6.6929	42.500 1.6732	334000 75200	0.35	1.74	86700 19500	51200 11500	1.69	381000 85600	30316	
80.000 3.1496	170.000 6.6929	61.500 2.4213	448000 101000	0.35	1.74	116000 26100	68700 15400	1.69	566000 127000	32316	
85.000 3.3465	130.000 5.1181	29.000 1.1417	163000 36500	0.44	1.36	42100 9470	31900 7170	1.32	235000 52900	32017X	
85.000 3.3465	130.000 5.1181	29.000 1.1417	163000 36500	0.44	1.36	42100 9470	31900 7170	1.32	235000 52900	XAA32017X/Y32017X	
85.000 3.3465	130.000 5.1181	30.000 1.1811	161000 36300	0.44	1.35	41800 9400	31800 7150	1.31	245000 55100	JM716648/JM716610	
85.000 3.3465	130.000 5.1181	30.000 1.1811	161000 36300	0.44	1.35	41800 9400	31800 7150	1.31	245000 55100	JM716649/JM716610	
85.000 3.3465	130.000 5.1181	36.000 1.4173	220000 49500	0.29	2.06	57100 12800	28500 6410	2.00	343000 77100	33017	
85.000 3.3465	140.000 5.5118	39.000 1.5354	238000 53400	0.41	1.47	61600 13800	42900 9650	1.43	339000 76300	JHM516849/JHM516810	
85.000 3.3465	140.000 5.5118	41.000 1.6142	254000 57100	0.41	1.48	65800 14800	45800 10300	1.44	386000 86800	33117	
85.000 3.3465	150.000 5.9055	30.500 1.2008	199000 44800	0.42	1.43	51700 11600	37200 8350	1.39	236000 53000	30217	
85.000 3.3465	150.000 5.9055	38.500 1.5157	245000 55100	0.42	1.43	63600 14300	45700 10300	1.39	305000 68700	32217	
85.000 3.3465	150.000 5.9055	46.000 1.8110	332000 74600	0.33	1.80	86000 19300	49000 11000	1.76	446000 100000	JH217249/JH217210	
85.000 3.3465	150.000 5.9055	49.000 1.9291	351000 79000	0.42	1.43	91000 20500	65200 14700	1.40	483000 109000	33217	
85.000 3.3465	170.000 6.6929	48.000 1.8898	319000 71700	.80	0.75	82700 18600	113000 25500	0.73	423000 95200	JW8549/JW8510	
85.000 3.3465	180.000 7.0866	44.500 1.7520	284000 63900	0.83	0.73	73700 16600	104000 23400	0.71	366000 82300	31317	
85.000 3.3465	180.000 7.0866	44.500 1.7520	313000 70500	0.35	1.74	81300 18300	48000 10800	1.69	346000 77700	30317	

<sup>(1)</sup>Based on 1 x 10<sup>6</sup> revolutions L<sub>10</sub> life, for the ISO life-calculation method.

<sup>(2)</sup>Consult your Timken engineer for instructions on use or review the Timken Engineering Manual on timken.com/catalogs.

<sup>(3)</sup>Based on 90 x 10<sup>6</sup> revolutions L<sub>10</sub> life, for The Timken Company life-calculation method. C<sub>90</sub> and C<sub>a90</sub> are radial and thrust values.

Bearing Dimensions											Geometry Factors			Bearing Weight
Width B	Width C	Eff. Ctr. a <sup>(4)</sup>	Shaft			Housing			Cage		G <sub>1</sub>	G <sub>2</sub>	C <sub>g</sub>	
			Max Shaft Fillet Radius R <sup>(5)</sup>	Backing Shoulder Dia. d <sub>a</sub> d <sub>b</sub>		Max Housing Fillet Radius r <sup>(5)</sup>	Backing Shoulder Dia. D <sub>a</sub> D <sub>b</sub>		A <sub>a</sub> <sup>(6)</sup>	A <sub>b</sub> <sup>(7)</sup>				
mm in.	mm in.	mm in.	mm in.	mm in.	mm in.	mm in.	mm in.	mm in.	mm in.	mm in.				kg lbs.
39.000 1.5354	27.000 1.0630	10.7 0.42	3.0 0.12	97.0 3.82	114.0 4.49	2.5 0.10	159.5 6.28	146.0 5.75	6.9 0.27	5.3 0.21	105.0	21.4	0.0973	4.06 8.95
39.000 1.5354	33.000 1.2992	-8.1 -0.32	3.0 0.12	96.0 3.78	100.0 3.94	2.5 0.10	159.0 6.26	154.0 6.06	3.2 0.12	4.5 0.18	147.1	37.6	0.0831	4.31 9.50
58.000 2.2835	48.000 1.8898	-19.0 -0.75	3.0 0.12	100.0 3.94	105.0 4.13	2.5 0.10	159.0 6.26	152.0 5.98	6.9 0.27	4.0 0.16	196.5	27.7	0.0923	6.34 13.99
29.000 1.1417	22.000 0.8661	-0.5 -0.02	1.5 0.06	92.0 3.62	95.0 3.74	1.5 0.06	125.0 4.92	119.0 4.69	2.1 0.08	2.8 0.11	109.2	34.9	0.1270	1.33 2.93
29.000 1.1417	22.000 0.8661	-0.5 -0.02	6.5 0.26	92.0 3.62	106.0 4.17	1.5 0.06	125.0 4.92	119.0 4.69	2.1 0.08	2.8 0.11	109.2	34.9	0.1270	1.31 2.89
29.000 1.1417	24.000 0.9449	-0.3 -0.01	6.0 0.24	92.0 3.62	104.0 4.09	2.5 0.10	125.0 4.92	117.0 4.61	1.8 0.07	3.0 0.12	117.1	38.4	0.1300	1.32 2.92
29.000 1.1417	24.000 0.9449	-0.3 -0.01	3.0 0.12	92.0 3.62	98.0 3.86	2.5 0.10	125.0 4.92	117.0 4.61	1.8 0.07	3.0 0.12	117.1	38.4	0.1180	1.34 2.96
36.000 1.4173	29.500 1.1614	-9.4 -0.37	1.5 0.06	93.0 3.66	96.0 3.78	1.5 0.06	125.0 4.92	120.0 4.72	1.5 0.05	2.8 0.11	157.9	55.6	0.0865	1.73 3.83
38.000 1.4961	31.500 1.2402	-5.8 -0.23	3.0 0.12	94.0 3.70	100.0 3.94	2.5 0.10	134.0 5.28	125.0 4.92	0.8 0.03	4.3 0.17	140.9	35.2	0.0929	2.27 5.00
41.000 1.6142	32.000 1.2598	-8.1 -0.32	2.5 0.10	96.0 3.78	102.0 4.02	2.0 0.08	135.0 5.31	126.0 4.96	4.4 0.17	2.8 0.11	160.9	39.6	0.0972	2.45 5.42
28.000 1.1024	24.000 0.9449	-0.3 -0.01	2.5 0.10	93.0 3.66	97.0 3.82	2.0 0.08	142.0 5.59	137.0 5.39	2.0 0.08	4.2 0.17	101.2	24.9	0.0833	2.07 4.57
36.000 1.4173	30.000 1.1811	-4.6 -0.18	2.5 0.10	94.0 3.70	100.0 3.94	2.0 0.08	142.0 5.59	134.0 5.28	4.0 0.16	3.2 0.13	121.4	32.6	0.0888	2.62 5.78
46.000 1.8110	38.000 1.4961	-11.9 -0.47	3.0 0.12	95.0 3.74	101.0 3.98	2.5 0.10	142.0 5.59	134.0 5.28	0.5 0.02	4.1 0.16	169.3	33.3	0.0924	3.34 7.36
49.000 1.9291	37.000 1.4567	-11.7 -0.46	2.5 0.10	94.0 3.70	103.0 4.06	2.0 0.08	144.0 5.67	134.0 5.28	5.6 0.22	3.3 0.13	167.6	33.3	0.0995	3.60 7.92
45.000 1.7717	33.000 1.2992	7.4 0.29	4.0 0.16	100.0 3.94	123.0 4.84	4.0 0.16	161.5 6.36	142.0 5.59	6.4 .25	4.8 .19	148.7	29.9	0.1160	4.80 10.60
41.000 1.6142	28.000 1.1024	11.9 0.47	4.0 0.16	110.0 4.33	120.0 4.72	1.7 0.07	169.0 6.65	154.0 6.06	8.1 0.32	5.6 0.22	145.7	31.3	0.1090	4.97 10.95
41.000 1.6142	34.000 1.3386	-9.7 -0.38	4.0 0.16	100.0 3.94	106.0 4.17	3.0 0.12	166.5 6.56	162.0 6.38	6.0 0.23	3.6 0.14	143.9	41.7	0.0823	4.78 10.54

<sup>(4)</sup>Negative value indicates effective center inside cone (inner-ring) backface.

<sup>(5)</sup>These maximum fillet radii will be cleared by the bearing corners.

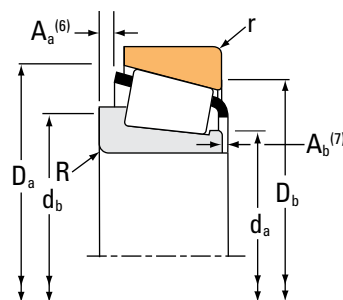
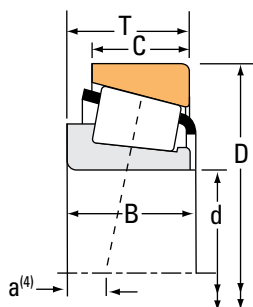
<sup>(6)</sup>Negative value indicates cage extends beyond cone (inner-ring) backface.

<sup>(7)</sup>Negative value indicates cage that does not extend beyond cone (inner-ring) front face.

Continued on next page.

# TAPERED ROLLER BEARINGS

SINGLE-ROW • Metric



Bearing Dimensions			Load Ratings							Part Number		
Bore d	O.D. D	Width T	Dynamic <sup>(1)</sup>		Factors <sup>(2)</sup>		Dynamic <sup>(3)</sup>		Factors <sup>(2)</sup>		Static C <sub>0</sub>	Assembly Inner/Outer
			C <sub>1</sub>	e	Y	C <sub>90</sub>	C <sub>a90</sub>	K	C <sub>0</sub>			
mm in.	mm in.	mm in.	N lbf			N lbf	N lbf		N lbf			
85.000 3.3465	180.000 7.0866	63.500 2.5000	481000 108000	0.35	1.74	125000 28000	73600 16500	1.69	588000 132000		32317	
90.000 3.5433	140.000 5.5118	32.000 1.2598	183000 41200	0.42	1.42	47500 10700	34400 7740	1.38	264000 59400		32018X	
90.000 3.5433	140.000 5.5118	32.000 1.2598	183000 41200	0.42	1.42	47500 10700	34400 7740	1.38	264000 59400		XAA32018X/Y32018X	
90.000 3.5433	140.000 5.5118	39.000 1.5354	247000 55600	0.27	2.23	64100 14400	29500 6630	2.17	377000 84700		33018	
90.000 3.5433	145.000 5.7087	35.000 1.3780	222000 50000	0.44	1.35	57700 13000	43900 9860	1.31	313000 70500		JM718149/JM718110	
90.000 3.5433	150.000 5.9055	42.000 1.6535	252000 56600	0.55	1.10	65300 14700	61000 13700	1.07	386000 86800		JT9049/JT9010	
90.000 3.5433	150.000 5.9055	45.000 1.7717	306000 68800	0.40	1.51	79400 17800	54000 12100	1.47	447000 100000		33118	
90.000 3.5433	155.000 6.1024	44.000 1.7323	331000 74400	0.34	1.76	85800 19300	50100 11300	1.71	447000 101000		JHM318448/JHM318410	
90.000 3.5433	160.000 6.2992	32.500 1.2795	240000 54100	0.42	1.43	62300 14000	44800 10100	1.39	295000 66200		30218	
90.000 3.5433	160.000 6.2992	42.500 1.6732	312000 70200	0.42	1.43	81000 18200	58200 13100	1.39	406000 91200		32218	
90.000 3.5433	190.000 7.4803	46.500 1.8307	324000 72800	0.83	0.73	84000 18900	119000 26700	0.71	421000 94600		31318	
90.000 3.5433	190.000 7.4803	46.500 1.8307	375000 84200	0.35	1.74	97100 21800	57400 12900	1.69	429000 96500		30318	
90.000 3.5433	190.000 7.4803	57.150 2.2500	534000 120000	0.33	1.79	138000 31100	79300 17800	1.74	692000 156000		JHH221436/JHH221413	
90.000 3.5433	190.000 7.4803	67.500 2.6574	575000 129000	0.35	1.74	149000 33500	88000 19800	1.69	683000 153000		32318	
95.000 3.7402	135.000 5.3150	20.000 0.7874	83000 18700	0.58	1.03	21500 4840	21500 4830	1.00	133000 29900		JL819349/JL819310	
95.000 3.7402	145.000 5.7087	32.000 1.2598	186000 41800	0.44	1.36	48200 10800	36500 8200	1.32	274000 61500		32019X	
95.000 3.7402	145.000 5.7087	39.000 1.5354	246000 55300	0.28	2.16	63800 14300	30400 6830	2.10	378000 85100		33019	

<sup>(1)</sup>Based on 1 x 10<sup>6</sup> revolutions L<sub>10</sub> life, for the ISO life-calculation method.

<sup>(2)</sup>Consult your Timken engineer for instructions on use or review the Timken Engineering Manual on timken.com/catalogs.

<sup>(3)</sup>Based on 90 x 10<sup>6</sup> revolutions L<sub>10</sub> life, for The Timken Company life-calculation method. C<sub>90</sub> and C<sub>a90</sub> are radial and thrust values.



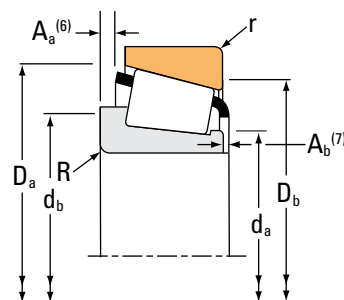
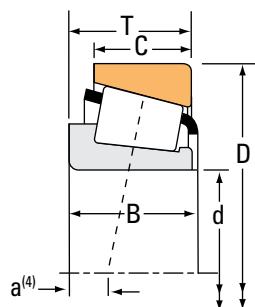
Bearing Dimensions											Geometry Factors			Bearing Weight
Width B	Width C	Eff. Ctr. a <sup>(4)</sup>	Shaft			Housing			Cage		G <sub>1</sub>	G <sub>2</sub>	C <sub>g</sub>	
			Max Shaft Fillet Radius R <sup>(5)</sup>	Backing Shoulder Dia. d <sub>a</sub> d <sub>b</sub>		Max Housing Fillet Radius r <sup>(5)</sup>	Backing Shoulder Dia. D <sub>a</sub> D <sub>b</sub>		A <sub>a</sub> <sup>(6)</sup>	A <sub>b</sub> <sup>(7)</sup>				
mm in.	mm in.	mm in.	mm in.	mm in.	mm in.	mm in.	mm in.	mm in.	mm in.	mm in.			kg lbs.	
60.000 2.3622	49.000 1.9291	-20.8 -0.82	4.0 0.16	103.0 4.06	112.0 4.41	3.0 0.12	167.0 6.57	161.0 6.34	6.6 0.26	6.9 0.27	205.6	31.5	0.0993	7.24 15.97
32.000 1.2598	24.000 0.9449	-2.0 -0.08	2.0 0.08	98.0 3.86	102.0 4.02	1.5 0.06	134.0 5.28	128.0 5.04	3.2 0.12	2.2 0.09	127.5	41.1	0.1317	1.70 3.75
32.000 1.2598	24.000 0.9449	-2.0 -0.08	6.0 0.24	98.0 3.86	111.0 4.37	1.5 0.06	134.0 5.28	128.0 5.04	3.2 0.12	2.2 0.09	127.5	41.1	0.1317	1.70 3.75
39.000 1.5354	32.500 1.2795	-10.9 -0.43	2.0 0.08	98.0 3.86	101.0 3.98	1.5 0.06	135.0 5.31	131.0 5.16	1.8 0.07	2.4 0.10	183.4	56.0	0.0884	2.20 4.85
34.000 1.3386	27.000 1.0630	-2.0 -0.08	3.0 0.12	99.0 3.90	106.0 4.17	2.5 0.10	138.8 5.46	131.0 5.16	1.5 0.06	4.6 0.18	138.0	34.9	0.0946	2.14 4.72
40.000 1.5748	34.000 1.3386	-0.8 -0.03	5.0 0.20	100.0 3.94	114.0 4.49	3.0 0.12	144.0 5.67	132.0 5.20	2.3 0.09	4.3 0.17	163.5	48.6	0.1010	2.90 6.40
45.000 1.7717	35.000 1.3780	-9.4 -0.37	2.5 0.10	100.0 3.94	108.0 4.25	2.0 0.08	145.0 5.71	135.0 5.31	3.8 0.15	3.0 0.12	180.1	43.2	0.1001	3.15 6.93
44.000 1.7323	35.500 1.3976	-9.9 -0.39	3.0 0.12	100.0 3.94	106.0 4.17	2.5 0.10	148.0 5.83	140.0 5.51	0.8 0.03	3.8 0.15	178.9	32.4	0.0948	3.32 7.32
30.000 1.1811	26.000 1.0236	-0.5 -0.02	2.5 0.10	102.0 4.02	106.0 4.17	2.0 0.08	152.0 5.98	146.0 5.75	3.9 0.15	4.6 0.18	125.9	47.7	0.0844	2.63 5.79
40.000 1.5748	34.000 1.3386	-6.1 -0.24	2.5 0.10	101.0 3.98	109.0 4.29	2.0 0.08	152.5 6.00	145.0 5.71	2.3 0.09	6.4 0.25	157.8	44.2	0.0914	3.47 7.66
43.000 1.6929	30.000 1.1811	13.2 0.52	4.0 0.16	117.0 4.61	128.0 5.04	3.0 0.12	180.0 7.09	164.0 6.46	6.9 0.27	6.6 0.26	169.3	37.1	0.1140	5.93 13.07
43.000 1.6929	36.000 1.4173	-9.4 -0.37	4.0 0.16	105.0 4.13	112.0 4.41	2.5 0.10	176.0 6.93	173.0 6.81	3.8 0.15	6.4 0.25	176.8	31.8	0.0882	5.56 12.25
57.531 2.2650	46.038 1.8125	-15.0 -0.59	8.0 0.31	106.0 4.17	121.0 4.76	3.3 0.13	179.0 7.05	171.0 6.73	2.0 0.08	3.8 0.15	265.6	28.4	0.1070	7.70 16.97
64.000 2.5197	53.000 2.0866	-19.6 -0.77	4.0 0.16	104.0 4.09	120.0 4.72	3.0 0.12	176.5 6.95	169.0 6.65	4.3 0.17	4.3 0.17	226.8	30.7	0.0963	8.51 18.77
20.000 0.7874	14.000 0.5512	10.9 0.43	5.0 0.20	102.0 4.02	111.0 4.37	2.5 0.10	129.0 5.08	123.0 4.84	2.0 0.08	2.0 0.08	93.3	70.6	0.1170	0.85 1.88
32.000 1.2598	24.000 0.9449	-0.5 -0.02	2.0 0.08	104.0 4.09	107.0 4.21	1.5 0.06	139.0 5.47	133.0 5.24	2.5 0.10	3.0 0.12	138.7	45.2	0.1240	1.77 3.91
39.000 1.5354	32.500 1.2795	-10.2 -0.40	2.0 0.08	102.0 4.02	106.0 4.17	1.5 0.06	139.0 5.47	133.0 5.24	1.3 0.05	3.0 0.12	192.5	48.4	0.0907	2.23 4.93

<sup>(4)</sup>Negative value indicates effective center inside cone (inner-ring) backface.  
<sup>(5)</sup>These maximum fillet radii will be cleared by the bearing corners.  
<sup>(6)</sup>Negative value indicates cage extends beyond cone (inner-ring) backface.  
<sup>(7)</sup>Negative value indicates cage that does not extend beyond cone (inner-ring) front face.

Continued on next page.

# TAPERED ROLLER BEARINGS

SINGLE-ROW • Metric



Bearing Dimensions			Load Ratings							Part Number	
Bore d	O.D. D	Width T	Dynamic <sup>(1)</sup>		Factors <sup>(2)</sup>		Dynamic <sup>(3)</sup>		Factors <sup>(2)</sup>	Static C <sub>0</sub>	Assembly Inner/Outer
			C <sub>1</sub>	e	Y	C <sub>90</sub>	C <sub>a90</sub>	K			
mm in.	mm in.	mm in.	N lbf			N lbf	N lbf		N lbf		
95.000 3.7402	145.000 5.7087	39.000 1.5354	246000 55300	0.28	2.16	63800 14300	30400 6830	2.10	378000 85100	XAA33019/Y33019	
95.000 3.7402	150.000 5.9055	35.000 1.3780	215000 48300	0.44	1.36	55700 12500	42100 9470	1.32	316000 71100	JM719149/JM719113	
95.000 3.7402	160.000 6.2992	46.000 1.8110	354000 79700	0.34	1.77	91900 20700	53200 12000	1.73	506000 114000	JF9549/JF9510	
95.000 3.7402	170.000 6.6929	34.500 1.3583	265000 59700	0.42	1.43	68800 15500	49500 11100	1.39	327000 73400	30219	
95.000 3.7402	170.000 6.6929	45.500 1.7913	316000 71100	0.42	1.43	82000 18400	59000 13300	1.39	401000 90100	32219	
95.000 3.7402	200.000 7.8740	49.500 1.9488	428000 96200	0.35	1.74	111000 24900	65500 14700	1.69	492000 111000	30319	
95.000 3.7402	200.000 7.8740	49.500 1.9488	360000 81000	0.83	0.73	93400 21000	132000 29700	0.71	438000 98400	31319	
95.000 3.7402	200.000 7.8740	71.500 2.8150	578000 130000	0.35	1.74	150000 33700	88500 19900	1.69	714000 161000	32319	
100.000 3.9370	145.000 5.7087	24.000 0.9449	125000 28200	0.47	1.27	32500 7310	26300 5920	1.24	172000 38700	JP10049/JP10010	
100.000 3.9370	145.000 5.7087	24.000 0.9449	125000 28200	0.47	1.27	32500 7310	26300 5920	1.24	172000 38700	JP10049A/JP10010A	
100.000 3.9370	150.000 5.9055	32.000 1.2598	195000 43700	0.46	1.31	50400 11300	39600 8900	1.27	295000 66400	32020X	
100.000 3.9370	150.000 5.9055	32.000 1.2598	162000 36500	0.50	1.20	42100 9470	36200 8130	1.16	242000 54400	JLM820048/JLM820012	
100.000 3.9370	150.000 5.9055	39.000 1.5354	251000 56300	0.29	2.09	65000 14600	31900 7180	2.03	393000 88300	33020	
100.000 3.9370	155.000 6.1024	36.000 1.4173	231000 52000	0.47	1.27	60000 13500	48600 10900	1.24	355000 79900	JM720249/JM720210	
100.000 3.9370	160.000 6.2992	41.000 1.6142	279000 62800	0.47	1.28	72400 16300	58300 13100	1.24	416000 93500	JHM720249/JHM720210	
100.000 3.9370	180.000 7.0866	37.000 1.4567	301000 67600	0.42	1.43	78000 17500	56100 12600	1.39	375000 84300	30220	
100.000 3.9370	180.000 7.0866	49.000 1.9291	368000 82700	0.42	1.43	95300 21400	68600 15400	1.39	478000 107000	32220	

<sup>(1)</sup>Based on 1 x 10<sup>6</sup> revolutions L<sub>10</sub> life, for the ISO life-calculation method.

<sup>(2)</sup>Consult your Timken engineer for instructions on use or review the Timken Engineering Manual on timken.com/catalogs.

<sup>(3)</sup>Based on 90 x 10<sup>6</sup> revolutions L<sub>10</sub> life, for The Timken Company life-calculation method. C<sub>90</sub> and C<sub>a90</sub> are radial and thrust values.

Bearing Dimensions											Geometry Factors			Bearing Weight
Width B	Width C	Eff. Ctr. a <sup>(4)</sup>	Shaft			Housing			Cage		G <sub>1</sub>	G <sub>2</sub>	C <sub>g</sub>	
			Max Shaft Fillet Radius R <sup>(5)</sup>	Backing Shoulder Dia. d <sub>a</sub> d <sub>b</sub>		Max Housing Fillet Radius r <sup>(5)</sup>	Backing Shoulder Dia. D <sub>a</sub> D <sub>b</sub>		A <sub>a</sub> <sup>(6)</sup>	A <sub>b</sub> <sup>(7)</sup>				
mm in.	mm in.	mm in.	mm in.	mm in.	mm in.	mm in.	mm in.	mm in.	mm in.	mm in.			kg lbs.	
39.000 1.5354	32.500 1.2795	-10.2 -0.40	6.0 0.24	102.0 4.02	114.0 4.49	1.5 0.06	139.0 5.47	133.0 5.24	1.8 0.07	2.3 0.09	192.5	48.4	0.0907	2.23 4.93
34.000 1.3386	27.000 1.0630	-1.6 -0.06	3.0 0.12	104.0 4.09	109.0 4.29	2.5 0.10	143.0 5.63	135.0 5.31	2.8 0.11	3.6 0.14	150.5	36.1	0.1410	2.15 4.75
46.000 1.8110	38.000 1.4961	-10.7 -0.42	3.0 0.12	105.4 4.15	111.0 4.37	3.0 0.12	154.0 6.06	145.0 5.71	0.8 0.03	3.8 0.15	209.8	39.7	0.0939	3.73 8.22
32.000 1.2598	27.000 1.0630	-0.8 -0.03	3.0 0.12	104.0 4.09	109.0 4.29	2.5 0.10	159.0 6.26	155.0 6.10	3.1 0.12	4.5 0.18	127.7	36.9	0.0898	3.02 6.65
43.000 1.6929	37.000 1.4567	-6.3 -0.25	3.0 0.12	106.0 4.17	111.0 4.37	2.5 0.10	161.0 6.34	152.0 5.98	4.7 0.18	3.0 0.12	165.5	35.3	0.0984	4.06 8.94
45.000 1.7717	38.000 1.4961	-9.4 -0.37	4.0 0.16	111.0 4.37	118.0 4.65	3.0 0.12	184.0 7.24	182.0 7.17	3.8 0.15	6.1 0.24	203.6	34.7	0.0925	6.64 14.65
45.000 1.7717	32.000 1.2598	12.7 0.50	4.0 0.16	117.0 4.61	134.0 5.28	3.0 0.12	189.0 7.44	171.0 6.73	8.1 0.32	7.1 0.28	167.0	29.8	0.1140	6.63 14.62
67.000 2.6378	55.000 2.1654	-23.4 -0.92	4.0 0.16	114.0 4.49	124.0 4.88	3.8 0.15	185.9 7.32	180.1 7.09	9.7 0.38	5.6 0.22	261.5	36.5	0.1010	9.74 21.47
22.500 0.8858	17.500 0.6890	6.1 0.24	3.0 0.12	106.0 4.17	112.0 4.41	3.0 0.12	140.0 5.51	134.0 5.28	1.3 0.05	3.8 0.15	104.0	40.9	0.1260	1.13 2.49
22.500 0.8858	17.500 0.6890	6.1 0.24	5.0 0.20	106.0 4.17	116.0 4.57	0.8 0.03	140.0 5.51	136.0 5.35	1.3 0.05	3.8 0.15	104.0	40.9	0.1260	1.15 2.54
32.000 1.2598	24.000 0.9449	0.8 0.03	2.0 0.08	108.0 4.25	112.0 4.41	1.5 0.06	145.0 5.71	137.0 5.39	3.5 0.13	2.3 0.09	153.8	50.3	0.1296	1.89 4.17
30.000 1.1811	26.000 1.0236	4.6 0.18	2.3 0.09	107.0 4.21	111.0 4.37	2.3 0.09	144.0 5.67	135.0 5.31	1.8 0.07	1.8 0.07	133.1	38.3	0.1410	1.81 3.99
39.000 1.5354	32.500 1.2795	-9.4 -0.37	2.0 0.08	107.0 4.21	111.0 4.37	1.5 0.06	144.0 5.67	139.0 5.47	1.9 0.07	2.4 0.10	206.3	65.1	0.0938	2.36 5.22
35.000 1.3780	28.000 1.1024	0.3 0.01	3.0 0.12	109.0 4.29	115.0 4.53	2.5 0.10	149.0 5.87	140.0 5.51	2.3 0.09	3.8 0.15	174.8	48.5	0.1040	2.36 5.20
40.000 1.5748	32.000 1.2598	-2.5 -0.10	3.0 0.12	109.4 4.30	117.0 4.61	2.5 0.10	153.9 6.06	143.0 5.63	2.8 0.11	4.3 0.17	187.7	45.3	0.1010	2.99 6.60
34.000 1.3386	29.000 1.1417	-0.8 -0.03	3.0 0.12	115.0 4.53	119.0 4.69	2.5 0.10	169.0 6.65	163.0 6.42	2.1 0.08	4.7 0.19	167.4	51.9	0.0927	3.76 8.30
46.000 1.8110	39.000 1.5354	-7.1 -0.28	3.0 0.12	112.0 4.41	117.0 4.61	2.5 0.10	170.0 6.69	163.0 6.42	5.8 0.22	3.3 0.13	198.1	39.4	0.1046	4.92 10.84

<sup>(4)</sup>Negative value indicates effective center inside cone (inner-ring) backface.

<sup>(5)</sup>These maximum fillet radii will be cleared by the bearing corners.

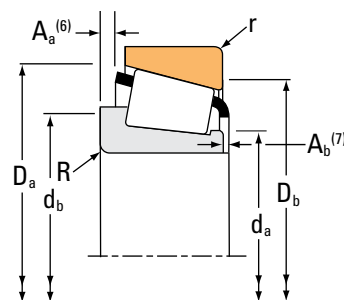
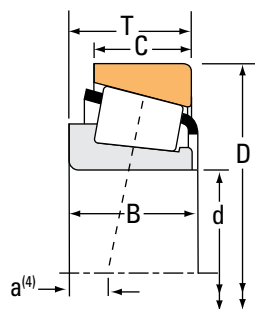
<sup>(6)</sup>Negative value indicates cage extends beyond cone (inner-ring) backface.

<sup>(7)</sup>Negative value indicates cage that does not extend beyond cone (inner-ring) front face.

Continued on next page.

# TAPERED ROLLER BEARINGS

SINGLE-ROW • Metric



Bearing Dimensions			Load Ratings							Part Number	
Bore d	O.D. D	Width T	Dynamic <sup>(1)</sup>		Factors <sup>(2)</sup>		Dynamic <sup>(3)</sup>		Factors <sup>(2)</sup>	Static	Assembly Inner/Outer
			C <sub>1</sub>	e	Y	C <sub>90</sub>	C <sub>a90</sub>	K	C <sub>0</sub>		
mm in.	mm in.	mm in.	N lbf			N lbf	N lbf		N lbf		
100.000 3.9370	180.000 7.0866	63.000 2.4803	488000 110000	0.40	1.48	127000 28500	87600 19700	1.44	679000 153000	33220	
100.000 3.9370	215.000 8.4646	51.500 2.0276	423000 95200	0.35	1.74	110000 24700	64800 14600	1.69	579000 130000	30320	
100.000 3.9370	215.000 8.4646	56.500 2.2244	416000 93600	0.83	0.73	108000 24300	152000 34300	0.71	526000 118000	31320X	
100.000 3.9370	215.000 8.4646	66.675 2.6250	642000 144000	0.33	1.84	166000 37400	92800 20900	1.79	906000 204000	JHH224333/JHH224315	
100.000 3.9370	215.000 8.4646	77.500 3.0512	586000 132000	0.35	1.74	152000 34200	89800 20200	1.69	883000 198000	32320	
105.000 4.1339	160.000 6.2992	35.000 1.3780	227000 51000	0.44	1.35	58900 13200	44800 10100	1.31	339000 76200	32021X	
105.000 4.1339	160.000 6.2992	43.000 1.6929	291000 65400	0.28	2.12	75400 17000	36500 8200	2.07	449000 101000	33021	
105.000 4.1339	190.000 7.4803	39.000 1.5354	325000 73200	0.42	1.43	84400 19000	60700 13600	1.39	407000 91400	30221	
105.000 4.1339	190.000 7.4803	53.000 2.0866	398000 89600	0.42	1.43	103000 23200	74300 16700	1.39	516000 116000	32221	
105.000 4.1338	225.000 8.8582	81.500 3.2086	726000 163000	0.35	1.74	188000 42300	111000 25000	1.69	989000 222000	32321	
110.000 4.3307	165.000 6.4961	35.000 1.3780	227000 51100	0.50	1.21	58900 13200	50100 11300	1.18	356000 80100	JM822049/JM822010	
110.000 4.3307	170.000 6.6929	38.000 1.4961	282000 63300	0.43	1.39	73000 16400	53700 12100	1.36	433000 97300	32022X	
110.000 4.3307	170.000 6.6929	47.000 1.8504	341000 76600	0.29	2.09	88300 19900	43400 9750	2.03	563000 126000	33022	
110.000 4.3307	180.000 7.0900	47.000 1.8504	371000 83500	0.41	1.48	96300 21600	66900 15000	1.44	554000 125000	JHM522649/JHM522610	
110.000 4.3307	180.000 7.0866	56.000 2.2047	412000 92700	0.42	1.43	107000 24000	76600 17200	1.40	635000 143000	33122	
110.000 4.3307	200.000 7.8740	41.000 1.6142	374000 84000	0.42	1.43	96900 21800	69700 15700	1.39	475000 107000	30222	
110.000 4.3307	200.000 7.8740	56.000 2.2047	493000 111000	0.42	1.43	128000 28700	91900 20700	1.39	668000 150000	32222	

<sup>(1)</sup>Based on 1 x 10<sup>6</sup> revolutions L<sub>10</sub> life, for the ISO life-calculation method.

<sup>(2)</sup>Consult your Timken engineer for instructions on use or review the Timken Engineering Manual on timken.com/catalogs.

<sup>(3)</sup>Based on 90 x 10<sup>6</sup> revolutions L<sub>10</sub> life, for The Timken Company life-calculation method. C<sub>90</sub> and C<sub>a90</sub> are radial and thrust values.

Bearing Dimensions											Geometry Factors			Bearing Weight
Width B	Width C	Eff. Ctr. a <sup>(4)</sup>	Shaft			Housing			Cage		G <sub>1</sub>	G <sub>2</sub>	C <sub>g</sub>	
			Max Shaft Fillet Radius R <sup>(5)</sup>	Backing Shoulder Dia. d <sub>a</sub> d <sub>b</sub>		Max Housing Fillet Radius r <sup>(5)</sup>	Backing Shoulder Dia. D <sub>a</sub> D <sub>b</sub>		A <sub>a</sub> <sup>(6)</sup>	A <sub>b</sub> <sup>(7)</sup>				
mm in.	mm in.	mm in.	mm in.	mm in.	mm in.	mm in.	mm in.	mm in.	mm in.	mm in.			kg lbs.	
63.000 2.4803	48.000 1.8898	-17.3 -0.68	3.0 0.12	112.0 4.41	122.0 4.80	2.5 0.10	172.0 6.77	160.0 6.30	6.9 0.27	4.3 0.17	256.3	44.0	0.1060	6.59 14.53
47.000 1.8504	39.000 1.5354	-7.9 -0.31	4.0 0.16	118.0 4.65	124.0 4.88	3.0 0.12	197.0 7.76	197.0 7.76	2.8 0.11	5.1 0.20	282.4	51.2	0.1030	8.37 18.45
51.000 2.0079	35.000 1.3780	11.4 0.45	4.0 0.16	122.9 4.84	144.0 5.67	3.0 0.12	202.0 7.95	183.9 7.24	9.7 0.38	8.6 0.34	196.1	30.1	0.1200	8.76 19.32
66.675 2.6250	53.975 2.1250	-18.9 -0.74	7.0 0.28	120.0 4.72	131.0 5.16	3.3 0.13	201.7 7.94	193.0 7.60	4.1 0.16	3.6 0.14	366.6	47.9	0.1180	11.52 25.40
73.000 2.8740	60.000 2.3622	-26.9 -1.06	4.0 0.16	124.0 4.88	129.0 5.08	3.0 0.12	200.0 7.87	193.0 7.60	13.0 0.51	6.1 0.24	376.3	54.8	0.1150	12.92 28.49
35.000 1.3780	26.000 1.0236	-0.3 -0.01	2.5 0.10	113.0 4.45	119.0 4.69	2.0 0.08	154.0 6.06	146.0 5.79	3.2 0.12	2.7 0.11	176.5	50.7	0.1024	2.40 5.28
43.000 1.6929	34.000 1.3386	-12.2 -0.48	2.5 0.10	113.0 4.45	118.0 4.65	2.0 0.08	153.0 6.02	147.0 5.79	3.1 0.12	3.1 0.13	236.3	54.8	0.0975	2.94 6.50
36.000 1.4173	30.000 1.1811	-1.3 -0.05	3.0 0.12	120.0 4.72	124.0 4.88	2.5 0.10	179.0 7.05	172.0 6.77	4.5 0.18	1.1 0.05	186.7	59.4	0.0960	4.47 9.86
50.000 1.9685	43.000 1.6929	-7.9 -0.31	3.0 0.12	120.0 4.72	127.0 5.00	2.5 0.10	180.0 7.09	171.0 6.73	5.1 0.20	2.7 0.11	219.9	43.5	0.1082	5.94 13.09
77.000 3.0315	63.000 2.4803	-27.2 -1.07	4.0 0.16	128.0 5.04	138.0 5.43	3.0 0.12	209.0 8.23	202.0 7.95	11.2 0.44	6.3 0.25	368.1	37.6	0.1130	13.99 30.85
35.000 1.3780	26.500 1.0433	3.0 0.12	3.0 0.12	119.0 4.69	125.0 4.92	2.5 0.10	159.0 6.26	149.0 5.87	2.5 0.10	2.5 0.10	191.5	45.8	0.1590	2.45 5.39
38.000 1.4961	29.000 1.1417	-1.0 -0.04	2.5 0.10	119.0 4.69	124.0 4.88	2.0 0.08	164.0 6.46	156.0 6.14	3.2 0.12	3.0 0.12	222.1	49.3	0.1095	3.06 6.74
47.000 1.8504	37.000 1.4567	-13.7 -0.54	2.5 0.10	118.0 4.65	122.0 4.80	2.0 0.08	163.0 6.42	156.0 6.14	3.8 0.15	4.1 0.16	299.7	60.5	0.1000	3.82 8.42
46.000 1.8110	38.000 1.4961	-5.8 -0.23	3.0 0.12	122.0 4.80	127.0 5.00	2.5 0.10	172.0 6.77	162.0 6.38	2.0 0.08	4.6 0.18	259.2	52.1	0.1070	4.51 9.91
56.000 2.2047	43.000 1.6929	-11.9 -0.47	2.5 0.10	121.0 4.76	130.0 5.12	2.0 0.08	173.5 6.83	162.0 6.38	6.1 0.24	3.3 0.13	285.0	57.3	0.1110	5.38 11.86
38.000 1.4961	32.000 1.2598	-1.5 -0.06	3.0 0.12	126.0 4.96	130.0 5.12	2.5 0.10	187.0 7.36	181.0 7.13	4.1 0.16	5.7 0.23	219.5	59.8	0.1014	5.24 11.54
53.000 2.0866	46.000 1.8110	-10.1 -0.40	3.0 0.12	125.0 4.92	135.0 5.31	2.5 0.10	190.5 7.50	179.0 7.05	3.8 0.15	5.2 0.21	277.3	55.7	0.1102	7.28 16.06

<sup>(4)</sup>Negative value indicates effective center inside cone (inner-ring) backface.

<sup>(5)</sup>These maximum fillet radii will be cleared by the bearing corners.

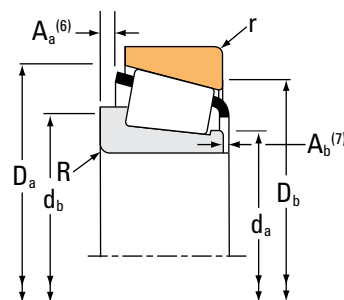
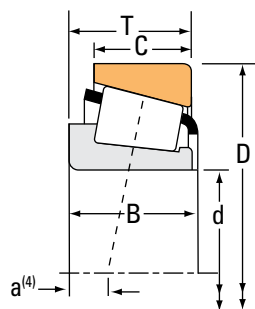
<sup>(6)</sup>Negative value indicates cage extends beyond cone (inner-ring) backface.

<sup>(7)</sup>Negative value indicates cage that does not extend beyond cone (inner-ring) front face.

Continued on next page.

# TAPERED ROLLER BEARINGS

SINGLE-ROW • Metric



Bearing Dimensions			Load Ratings							Part Number	
Bore d	O.D. D	Width T	Dynamic <sup>(1)</sup>		Factors <sup>(2)</sup>		Dynamic <sup>(3)</sup>		Factors <sup>(2)</sup>	Static	Assembly Inner/Outer
			C <sub>1</sub>	e	Y	C <sub>90</sub>	C <sub>a90</sub>	K	C <sub>0</sub>		
mm in.	mm in.	mm in.	N lbf			N lbf	N lbf		N lbf		
110.000 4.3307	240.000 9.4488	54.500 2.1457	502000 113000	0.35	1.74	130000 29300	76900 17300	1.69	732000 165000	30322	
110.000 4.3307	240.000 9.4488	63.000 2.4803	523000 117000	0.83	0.73	135000 30500	191000 43000	0.71	663000 149000	31322X	
110.000 4.3307	240.000 9.4488	84.500 3.3268	760000 171000	0.35	1.74	197000 44300	116000 26200	1.69	1020000 229000	32322	
115.000 4.5276	165.000 6.4961	28.000 1.1024	160000 35900	0.46	1.31	41400 9310	32500 7310	1.27	245000 55100	JLM722948/JLM722912	
120.000 4.7244	165.000 6.4961	29.000 1.1417	179000 40300	0.35	1.72	46500 10500	27800 6240	1.68	308000 69300	32924	
120.000 4.7244	170.000 6.6929	25.400 1.0000	145000 32600	0.46	1.31	37600 8450	29500 6640	1.27	231000 52000	JL724348/JL724314	
120.000 4.7244	170.000 6.6929	27.000 1.0630	165000 37200	0.47	1.27	42900 9640	34700 7800	1.24	238000 53500	JP12049/JP12010	
120.000 4.7244	170.000 6.6929	27.000 1.0630	165000 37200	0.47	1.27	42900 9640	34700 7800	1.24	238000 53500	JP12049A/JP12010	
120.000 4.7244	180.000 7.0866	36.000 1.4173	247000 55500	0.41	1.45	64000 14400	45300 10200	1.41	377000 84700	JM624649/JM624610	
120.000 4.7244	180.000 7.0866	38.000 1.4961	292000 65700	0.46	1.31	75800 17000	59500 13400	1.27	466000 105000	32024X	
120.000 4.7244	180.000 7.0866	38.000 1.4961	292000 65700	0.46	1.31	75800 17000	59500 13400	1.27	466000 105000	XAA32024X/Y32024X	
120.000 4.7244	180.000 7.0866	48.000 1.8898	352000 79200	0.31	1.97	91300 20500	47700 10700	1.91	603000 135000	33024	
120.000 4.7244	215.000 8.4646	43.500 1.7126	374000 84100	0.44	1.38	97000 21800	72300 16200	1.34	508000 114000	30224	
120.000 4.7244	215.000 8.4646	61.500 2.4213	553000 124000	0.44	1.38	143000 32200	107000 24000	1.34	831000 187000	32224	
120.000 4.7244	260.000 10.2362	59.500 2.3425	624000 140000	0.35	1.74	162000 36400	95500 21500	1.69	807000 181000	30324	
120.000 4.7244	260.000 10.2362	68.000 2.6772	606000 136000	0.83	0.73	157000 35300	222000 49900	0.71	777000 175000	31324X	
120.000 4.7244	260.000 10.2362	90.500 3.5630	908000 204000	0.35	1.74	235000 52900	139000 31200	1.69	1250000 281000	32324	

<sup>(1)</sup>Based on 1 x 10<sup>6</sup> revolutions L<sub>10</sub> life, for the ISO life-calculation method.

<sup>(2)</sup>Consult your Timken engineer for instructions on use or review the Timken Engineering Manual on timken.com/catalogs.

<sup>(3)</sup>Based on 90 x 10<sup>6</sup> revolutions L<sub>10</sub> life, for The Timken Company life-calculation method. C<sub>90</sub> and C<sub>a90</sub> are radial and thrust values.

Bearing Dimensions											Geometry Factors			Bearing Weight
Width B	Width C	Eff. Ctr. a <sup>(4)</sup>	Shaft			Housing			Cage		G <sub>1</sub>	G <sub>2</sub>	C <sub>g</sub>	
			Max Shaft Fillet Radius R <sup>(5)</sup>	Backing Shoulder Dia. d <sub>a</sub> d <sub>b</sub>		Max Housing Fillet Radius r <sup>(5)</sup>	Backing Shoulder Dia. D <sub>a</sub> D <sub>b</sub>		A <sub>a</sub> <sup>(6)</sup>	A <sub>b</sub> <sup>(7)</sup>				
mm in.	mm in.	mm in.	mm in.	mm in.	mm in.	mm in.	mm in.	mm in.	mm in.	mm in.				kg lbs.
50.000 1.9685	42.000 1.6535	-6.9 -0.27	4.0 0.16	130.0 5.12	137.0 5.39	4.5 0.18	220.0 8.66	223.0 8.78	2.8 0.11	5.1 0.20	393.4	67.6	0.1150	11.50 25.35
57.000 2.2441	38.000 1.4961	11.7 0.46	4.0 0.16	135.0 5.35	150.0 5.94	3.0 0.12	224.5 8.84	206.0 8.11	13.2 0.52	9.1 0.36	250.5	34.3	0.1380	12.13 26.73
80.000 3.1496	65.000 2.5591	-27.9 -1.10	4.0 0.16	136.0 5.35	143.0 5.63	3.0 0.12	222.5 8.76	215.0 8.46	12.4 0.49	6.6 0.26	400.6	44.5	0.1160	16.99 37.45
27.000 1.0630	21.000 0.8268	5.6 0.22	3.3 0.13	121.0 4.76	127.0 5.00	3.0 0.12	158.0 6.22	151.0 5.94	1.8 0.07	3.0 0.12	161.0	57.2	0.1450	1.75 3.86
29.000 1.1417	23.000 0.9055	0.3 0.01	1.5 0.06	128.0 5.04	130.0 5.12	1.5 0.06	160.0 6.30	155.0 6.10	2.1 0.08	2.5 0.10	226.8	103.0	0.1488	1.78 3.92
25.400 1.0000	19.050 0.7500	7.9 0.31	3.3 0.13	127.0 5.00	132.0 5.20	3.3 0.13	163.0 6.42	156.0 6.14	2.0 0.08	2.0 0.08	170.2	70.6	0.1470	1.62 3.56
25.000 0.9843	19.500 0.7677	7.9 0.31	3.0 0.12	127.0 5.00	133.0 5.24	3.0 0.12	164.5 6.48	157.0 6.18	2.3 0.09	4.3 0.17	157.8	76.7	0.1310	1.71 3.76
25.000 0.9843	19.500 0.7677	7.9 0.31	6.0 0.24	127.0 5.00	139.0 5.47	3.0 0.12	164.5 6.48	157.0 6.18	2.3 0.09	4.3 0.17	157.8	76.7	0.1310	1.69 3.72
36.000 1.4173	26.000 1.0236	0.0 0.00	3.5 0.14	128.0 5.04	135.0 5.31	1.5 0.06	173.0 6.81	166.0 6.54	3.3 0.13	3.3 0.13	226.8	61.6	0.1080	2.93 6.46
38.000 1.4961	29.000 1.1417	1.5 0.06	2.5 0.10	130.0 5.12	134.0 5.28	2.0 0.08	174.0 6.85	165.0 6.50	3.4 0.13	3.0 0.12	255.1	58.3	0.1169	3.27 7.22
38.000 1.4961	29.000 1.1417	1.5 0.06	5.0 0.20	130.0 5.12	141.0 5.55	2.0 0.08	174.0 6.85	165.0 6.50	3.4 0.13	3.0 0.12	255.1	58.3	0.1169	3.25 7.19
48.000 1.8898	38.000 1.4961	-11.9 -0.47	2.5 0.10	130.0 5.12	134.0 5.28	2.0 0.08	172.0 6.77	166.0 6.54	3.8 0.15	3.3 0.13	342.0	93.7	0.1070	4.19 9.24
40.000 1.5748	34.000 1.3386	0.3 0.01	3.0 0.12	136.0 5.35	140.0 5.51	2.5 0.10	201.0 7.91	195.0 7.68	3.7 0.14	6.3 0.25	252.0	64.9	0.1072	6.24 13.75
58.000 2.2835	50.000 1.9685	-10.2 -0.40	3.0 0.12	135.0 5.31	147.0 5.79	2.5 0.10	204.5 8.05	191.0 7.52	5.6 0.22	6.9 0.27	352.0	68.1	0.1210	9.27 20.43
55.000 2.1654	46.000 1.8110	-8.1 -0.32	4.0 0.16	142.0 5.59	147.0 5.79	3.0 0.12	236.5 9.31	238.0 9.37	3.3 0.13	5.3 0.21	387.6	53.6	0.1140	14.17 31.23
62.000 2.4409	42.000 1.6535	13.2 0.52	4.0 0.16	147.1 5.79	172.0 6.77	3.0 0.12	244.1 9.61	223.0 8.78	13.5 0.53	10.4 0.41	303.2	37.8	0.1380	15.37 33.89
86.000 3.3858	69.000 2.7165	-29.5 -1.16	4.0 0.16	149.0 5.87	155.0 6.10	3.0 0.12	239.5 9.43	233.0 9.17	14.2 0.56	5.6 0.22	498.3	52.0	0.1250	21.52 47.45

<sup>(4)</sup>Negative value indicates effective center inside cone (inner-ring) backface.

<sup>(5)</sup>These maximum fillet radii will be cleared by the bearing corners.

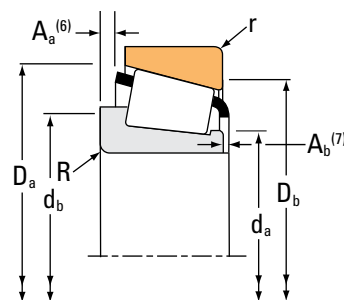
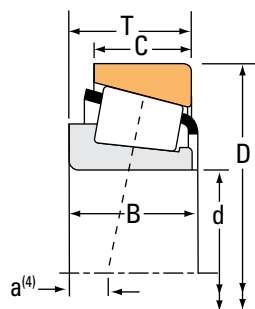
<sup>(6)</sup>Negative value indicates cage extends beyond cone (inner-ring) backface.

<sup>(7)</sup>Negative value indicates cage that does not extend beyond cone (inner-ring) front face.

Continued on next page.

# TAPERED ROLLER BEARINGS

SINGLE-ROW • Metric



Bearing Dimensions			Load Ratings							Part Number	
Bore d	O.D. D	Width T	Dynamic <sup>(1)</sup>		Factors <sup>(2)</sup>		Dynamic <sup>(3)</sup>		Factors <sup>(2)</sup>	Static	Assembly Inner/Outer
			C <sub>1</sub>	e	Y	C <sub>90</sub>	C <sub>a90</sub>	K	C <sub>0</sub>		
mm in.	mm in.	mm in.	N lbf			N lbf	N lbf		N lbf		
125.000 4.9213	175.000 6.8898	25.400 1.0000	150000 33700	0.48	1.26	38900 8750	31700 7130	1.23	246000 55300	JL725346/JL725316	
130.000 5.1181	180.000 7.0866	32.000 1.2598	210000 47200	0.34	1.77	54400 12200	31600 7110	1.72	356000 80000	32926	
130.000 5.1181	185.000 7.2835	29.000 1.1417	196000 44000	0.47	1.27	50800 11400	41100 9250	1.24	283000 63600	JP13049/JP13010	
130.000 5.1181	185.000 7.2835	29.000 1.1417	196000 44000	0.47	1.27	50800 11400	41100 9250	1.24	283000 63600	JP13049A/JP13010	
130.000 5.1181	200.000 7.8740	45.000 1.7717	386000 86900	0.43	1.38	100000 22500	74600 16800	1.34	617000 139000	32026X	
130.000 5.1181	230.000 9.0551	43.750 1.7224	407000 91500	0.44	1.38	105000 23700	78600 17700	1.34	550000 124000	30226	
130.000 5.1181	230.000 9.0551	67.750 2.6673	644000 145000	0.44	1.38	167000 37600	124000 28000	1.34	982000 221000	32226	
130.000 5.1181	240.000 9.4488	76.000 2.9921	618000 139000	0.36	1.67	160000 36000	98800 22200	1.62	955000 215000	JH429148/JH429111	
130.000 5.1181	280.000 11.0236	63.750 2.5098	752000 169000	0.35	1.74	195000 43800	115000 25900	1.69	990000 223000	30326	
130.000 5.1181	280.000 11.0236	63.750 2.5098	691000 155000	0.83	0.73	179000 40300	253000 56900	0.71	966000 217000	31326X	
130.000 5.1181	280.000 11.0236	98.750 3.8878	1120000 252000	0.35	1.74	291000 65300	172000 38600	1.69	1460000 329000	32326	
140.000 5.5118	190.000 7.4803	32.000 1.2598	227000 51000	0.36	1.67	58900 13200	36300 8160	1.62	405000 91100	32928	
140.000 5.5118	195.000 7.6772	29.000 1.1417	203000 45700	0.50	1.19	52700 11800	45400 10200	1.16	304000 68400	JP14049/JP14010	
140.000 5.5118	210.000 8.2677	45.000 1.7717	371000 83500	0.46	1.31	96300 21600	75600 17000	1.27	644000 145000	32028X	
140.000 5.5118	210.000 8.2677	45.000 1.7717	371000 83500	0.46	1.31	96300 21600	75600 17000	1.27	644000 145000	XAA32028X/Y32028X	
140.000 5.5118	250.000 9.8425	45.750 1.8012	474000 107000	0.44	1.38	123000 27600	91500 20600	1.34	649000 146000	30228	
140.000 5.5118	250.000 9.8425	71.750 2.8248	707000 159000	0.44	1.38	183000 41200	136000 30700	1.34	1070000 241000	32228	

<sup>(1)</sup>Based on 1 x 10<sup>6</sup> revolutions L<sub>10</sub> life, for the ISO life-calculation method.

<sup>(2)</sup>Consult your Timken engineer for instructions on use or review the Timken Engineering Manual on timken.com/catalogs.

<sup>(3)</sup>Based on 90 x 10<sup>6</sup> revolutions L<sub>10</sub> life, for The Timken Company life-calculation method. C<sub>90</sub> and C<sub>a90</sub> are radial and thrust values.



Bearing Dimensions											Geometry Factors			Bearing Weight
Width B	Width C	Eff. Ctr. a <sup>(4)</sup>	Shaft			Housing			Cage		G <sub>1</sub>	G <sub>2</sub>	C <sub>g</sub>	
			Max Shaft Fillet Radius R <sup>(5)</sup>	Backing Shoulder Dia. d <sub>a</sub> d <sub>b</sub>		Max Housing Fillet Radius r <sup>(5)</sup>	Backing Shoulder Dia. D <sub>a</sub> D <sub>b</sub>		A <sub>a</sub> <sup>(6)</sup>	A <sub>b</sub> <sup>(7)</sup>				
mm in.	mm in.	mm in.	mm in.	mm in.	mm in.	mm in.	mm in.	mm in.	mm in.	mm in.			kg lbs.	
25.400 1.0000	18.288 0.7200	9.1 0.36	3.3 0.13	133.0 5.24	138.0 5.43	3.3 0.13	168.0 6.61	161.0 6.34	2.3 0.09	2.3 0.09	186.6	77.7	0.1530	1.69 3.72
32.000 1.2598	25.000 0.9843	0.0 0.00	2.0 0.08	139.0 5.47	141.0 5.55	1.5 0.06	174.0 6.85	170.0 6.69	1.5 0.06	2.3 0.09	268.5	151.7	0.1410	2.36 5.19
27.000 1.0630	21.000 0.8268	8.9 0.35	3.0 0.12	137.0 5.39	143.0 5.63	3.0 0.12	179.0 7.05	172.0 6.77	1.5 0.06	4.8 0.19	192.2	60.3	0.1060	2.16 4.76
27.000 1.0630	21.000 0.8268	9.1 0.36	6.0 0.24	139.0 5.47	150.0 5.91	3.0 0.12	179.0 7.05	172.0 6.77	2.0 0.08	4.6 0.18	207.5	64.6	0.1030	2.19 4.83
45.000 1.7717	34.000 1.3386	-1.0 -0.04	2.5 0.10	142.0 5.59	148.0 5.83	2.0 0.08	193.0 7.60	184.0 7.24	3.9 0.15	2.0 0.08	338.4	97.3	0.1189	4.98 10.98
40.000 1.5748	34.000 1.3386	2.0 0.08	4.0 0.16	146.0 5.75	152.0 5.98	3.0 0.12	217.0 8.54	210.0 8.27	2.8 0.11	7.1 0.28	287.4	77.1	0.1118	7.06 15.56
64.000 2.5197	54.000 2.1260	-11.9 -0.47	4.0 0.16	145.0 5.71	161.0 6.34	3.0 0.12	221.0 8.70	206.0 8.11	6.1 0.24	6.4 0.25	424.6	78.3	0.1290	11.40 25.14
72.000 2.8346	60.000 2.3622	-19.3 -0.76	4.0 0.16	153.0 6.02	156.0 6.14	4.3 0.17	225.0 8.86	213.0 8.39	5.8 0.23	5.1 0.20	474.3	87.9	0.1250	14.25 31.41
58.000 2.2835	49.000 1.9291	-10.2 -0.40	5.0 0.20	152.0 5.98	161.0 6.34	4.0 0.16	255.0 10.04	253.0 9.96	4.8 0.19	8.6 0.34	478.0	40.1	0.1230	17.43 38.42
66.000 2.5984	44.000 1.7323	14.7 0.58	5.0 0.20	163.0 6.42	186.0 7.32	4.0 0.16	262.0 10.31	238.0 9.37	15.7 0.62	9.4 0.37	411.8	42.2	0.1280	19.16 42.23
93.000 3.6614	78.000 3.0709	-28.7 -1.13	5.0 0.20	156.0 6.14	171.0 6.73	5.0 0.20	261.0 10.28	251.0 9.88	11.4 0.45	6.4 0.25	557.1	47.5	0.1290	26.99 59.50
32.000 1.2598	25.000 0.9843	2.3 0.09	2.0 0.08	148.0 5.83	151.0 5.94	1.5 0.06	184.0 7.24	179.0 7.05	1.5 0.06	2.7 0.11	314.5	144.7	0.1509	2.50 5.53
27.000 1.0630	21.000 0.8268	12.2 0.48	3.0 0.12	149.0 5.87	153.0 6.02	3.0 0.12	189.0 7.44	182.0 7.17	1.3 0.05	5.6 0.22	219.5	68.2	0.1100	2.31 5.07
45.000 1.7717	34.000 1.3386	1.4 0.06	2.5 0.10	151.0 5.94	158.0 6.22	2.0 0.08	203.0 7.99	193.0 7.60	3.0 0.12	3.0 0.12	374.2	108.2	0.1250	5.29 11.66
45.000 1.7717	34.000 1.3386	1.4 0.06	6.5 0.26	151.0 5.94	158.0 6.22	2.0 0.08	203.0 7.99	193.0 7.60	3.9 0.15	2.0 0.08	374.2	108.2	0.1249	5.23 11.54
42.000 1.6535	36.000 1.4173	2.8 0.11	4.0 0.16	157.0 6.18	164.0 6.46	3.0 0.12	234.0 9.21	227.0 8.94	4.3 0.17	7.4 0.29	347.8	75.8	0.1191	8.92 19.65
68.000 2.6772	58.000 2.2835	-10.2 -0.40	4.0 0.16	159.0 6.26	171.0 6.73	3.0 0.01	238.5 9.39	223.0 8.78	6.6 0.26	5.3 0.21	492.8	64.7	0.1350	14.33 31.58

<sup>(4)</sup>Negative value indicates effective center inside cone (inner-ring) backface.

<sup>(5)</sup>These maximum fillet radii will be cleared by the bearing corners.

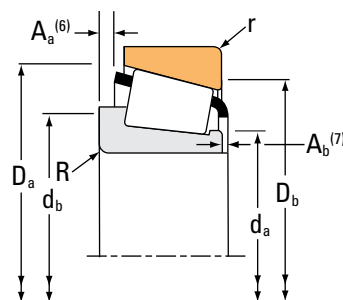
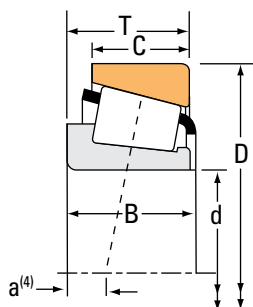
<sup>(6)</sup>Negative value indicates cage extends beyond cone (inner-ring) backface.

<sup>(7)</sup>Negative value indicates cage that does not extend beyond cone (inner-ring) front face.

Continued on next page.

# TAPERED ROLLER BEARINGS

SINGLE-ROW • Metric



Bearing Dimensions			Load Ratings							Part Number	
Bore d	O.D. D	Width T	Dynamic <sup>(1)</sup>		Factors <sup>(2)</sup>		Dynamic <sup>(3)</sup>		Factors <sup>(2)</sup>	Static	Assembly Inner/Outer
			C <sub>1</sub>	e	Y	C <sub>90</sub>	C <sub>a90</sub>	K	C <sub>0</sub>		
mm in.	mm in.	mm in.	N lbf			N lbf	N lbf		N lbf		
140.000 5.5118	300.000 11.8110	77.000 3.0315	785000 176000	0.83	0.73	203000 45700	287000 64600	0.71	1020000 230000	31328X	
150.000 5.9055	205.000 8.0709	28.575 1.1250	183000 41100	0.46	1.31	47400 10700	37200 8370	1.27	339000 76100	JL730646/JL730612	
150.000 5.9055	210.000 8.2677	38.000 1.4961	306000 68800	0.33	1.83	79300 17800	44500 10000	1.78	573000 129000	32930	
150.000 5.9055	225.000 8.8583	48.000 1.8898	418000 94000	0.46	1.31	108000 24400	85100 19100	1.27	730000 164000	32030X	
150.000 5.9055	225.000 8.8583	59.000 2.3228	530000 119000	0.36	1.65	137000 30900	85800 19300	1.60	949000 213000	33030	
150.000 5.9055	270.000 10.6299	49.000 1.9291	533000 120000	0.44	1.38	138000 31100	103000 23100	1.34	735000 165000	30230	
150.000 5.9055	270.000 10.6299	77.000 3.0315	804000 181000	0.44	1.38	208000 46800	155000 34900	1.34	1230000 276000	32230	
150.000 5.9055	320.000 12.5984	82.000 3.2283	862000 194000	0.83	0.73	224000 50300	316000 71000	0.71	1200000 270000	31330X	
160.000 6.2992	220.000 8.6614	32.000 1.2598	229000 51400	0.49	1.23	59300 13300	49300 11100	1.20	372000 83700	JP16049/JP16010	
160.000 6.2992	240.000 9.4488	46.000 1.8110	401000 90200	0.44	1.37	104000 23400	77900 17500	1.34	759000 171000	JM734445/JM734410	
160.000 6.2992	240.000 9.4488	51.000 2.0079	487000 109000	0.46	1.31	126000 28400	99100 22300	1.27	867000 195000	32032X	
160.000 6.2992	255.000 10.0394	63.500 2.5000	600000 135000	0.26	2.27	156000 35000	70400 15800	2.21	1040000 233000	JHM133449/JHM133417	
160.000 6.2992	290.000 11.4173	52.000 2.0472	573000 129000	0.44	1.38	149000 33400	111000 24900	1.34	868000 195000	30232	
160.000 6.2992	290.000 11.4173	84.000 3.3071	1020000 229000	0.44	1.38	264000 59400	197000 44200	1.34	1630000 366000	32232	
170.000 6.6929	230.000 9.0551	32.000 1.2598	252000 56700	0.46	1.30	65400 14700	51700 11600	1.27	436000 98100	JP17049/JP17010	
170.000 6.6929	230.000 9.0551	38.000 1.4961	329000 74000	0.38	1.57	85300 19200	56000 12600	1.52	637000 143000	32934	
170.000 6.6929	230.000 9.0551	39.000 1.5354	316000 71100	0.38	1.57	82000 18400	53800 12100	1.52	590000 133000	JHM534149/JHM534110	

<sup>(1)</sup>Based on 1 x 10<sup>6</sup> revolutions L<sub>10</sub> life, for the ISO life-calculation method.

<sup>(2)</sup>Consult your Timken engineer for instructions on use or review the Timken Engineering Manual on timken.com/catalogs.

<sup>(3)</sup>Based on 90 x 10<sup>6</sup> revolutions L<sub>10</sub> life, for The Timken Company life-calculation method. C<sub>90</sub> and C<sub>a90</sub> are radial and thrust values.

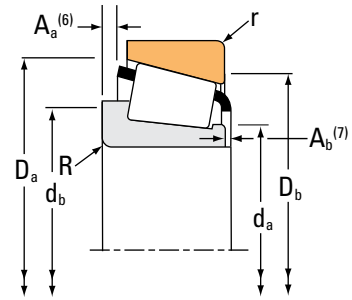
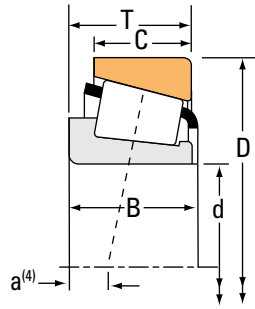
Bearing Dimensions											Geometry Factors			Bearing Weight
Width B	Width C	Eff. Ctr. a <sup>(4)</sup>	Shaft			Housing			Cage		G <sub>1</sub>	G <sub>2</sub>	C <sub>g</sub>	
			Max Shaft Fillet Radius R <sup>(5)</sup>	Backing Shoulder Dia. d <sub>a</sub> d <sub>b</sub>		Max Housing Fillet Radius r <sup>(5)</sup>	Backing Shoulder Dia. D <sub>a</sub> D <sub>b</sub>		A <sub>a</sub> <sup>(6)</sup>	A <sub>b</sub> <sup>(7)</sup>				
mm in.	mm in.	mm in.	mm in.	mm in.	mm in.	mm in.	mm in.	mm in.	mm in.	mm in.			kg lbs.	
70.000 2.7559	47.000 1.8504	16.5 0.65	5.0 0.20	171.0 6.73	199.0 7.83	4.0 0.16	280.4 11.04	257.0 10.12	16.5 0.65	9.7 0.38	424.5	45.2	0.1290	22.85 50.37
28.575 1.1250	21.438 0.8440	11.4 0.45	3.3 0.13	158.0 6.22	164.0 6.46	3.3 0.13	198.0 7.80	190.0 7.48	2.0 0.08	2.0 0.08	295.2	103.6	0.1760	2.61 5.76
38.000 1.4961	30.000 1.1811	-1.5 -0.06	2.5 0.10	160.0 6.30	163.0 6.42	2.0 0.08	203.0 7.99	197.0 7.76	1.5 0.06	3.9 0.16	428.9	157.2	0.1167	3.99 8.82
48.000 1.8898	36.000 1.4173	1.0 0.04	3.0 0.12	163.0 6.42	169.0 6.65	2.5 0.10	217.0 8.54	206.0 8.11	2.9 0.11	4.0 0.16	437.0	114.5	0.1314	6.38 14.08
59.000 2.3228	46.000 1.8110	-10.9 -0.43	3.0 0.12	161.0 6.34	169.0 6.65	2.5 0.10	218.0 8.58	207.0 8.15	4.6 0.18	4.6 0.18	541.5	102.4	0.1320	8.00 17.63
45.000 1.7717	38.000 1.4961	3.6 0.14	4.0 0.16	168.0 6.61	174.0 6.85	3.0 0.12	250.0 9.84	245.0 9.65	2.9 0.11	7.5 0.30	407.0	78.5	0.1254	11.03 24.29
73.000 2.8740	60.000 2.3622	-11.7 -0.46	4.0 0.16	170.0 6.69	183.0 7.20	3.0 0.12	254.0 10.02	244.0 9.61	9.1 0.36	5.6 0.22	579.4	64.2	0.1190	17.69 38.99
75.000 2.9528	50.000 1.9685	18.0 0.71	5.0 0.20	187.0 7.36	210.0 8.27	4.0 0.16	300.0 11.81	276.0 10.87	18.5 0.73	8.9 0.35	544.4	54.9	0.1410	28.15 62.07
30.000 1.1811	23.000 0.9055	13.0 0.51	3.0 0.12	169.0 6.65	174.0 6.85	3.0 0.12	213.1 8.39	206.0 8.11	3.0 0.12	4.8 0.19	294.4	123.3	0.1230	3.11 6.86
44.500 1.7520	37.000 1.4567	5.1 0.20	3.0 0.12	173.0 6.81	178.0 7.01	2.5 0.10	232.0 9.13	222.0 8.74	2.0 0.08	4.8 0.19	548.5	117.5	0.1160	7.13 15.73
51.000 2.0079	38.000 1.4961	1.8 0.07	3.0 0.12	174.0 6.85	181.0 7.13	2.5 0.10	234.0 9.21	221.0 8.70	3.5 0.13	4.1 0.16	521.7	133.9	0.1166	7.81 17.21
69.850 2.7500	52.388 2.0625	-17.3 -0.68	1.5 0.06	173.0 6.81	173.0 6.81	3.3 0.13	233.7 9.20	231.0 9.09	1.5 0.06	1.8 0.07	668.6	103.2	0.1340	12.45 27.44
48.000 1.8898	40.000 1.5748	5.1 0.20	4.0 0.16	178.0 7.01	185.0 7.28	3.0 0.12	269.0 10.59	266.0 10.47	5.3 0.21	6.1 0.24	543.0	78.0	0.1160	13.77 30.35
80.000 3.1496	67.000 2.6378	-12.7 -0.50	4.0 0.16	185.0 7.28	197.0 7.76	3.0 0.12	274.5 10.81	261.0 10.28	8.4 0.33	6.6 0.26	766.7	69.4	0.1310	23.41 51.62
30.000 1.1811	23.000 0.9055	13.0 0.51	3.0 0.12	179.0 7.05	184.0 7.24	3.0 0.12	223.0 8.78	217.0 8.54	2.8 0.11	4.8 0.19	361.9	156.4	0.1020	3.44 7.59
38.000 1.4961	30.000 1.1811	3.8 0.15	2.5 0.10	179.0 7.05	183.0 7.20	2.0 0.08	223.0 8.78	215.0 8.46	2.0 0.08	4.6 0.18	519.3	180.0	0.1305	4.40 9.71
38.000 1.4961	31.000 1.2205	4.6 0.18	3.0 0.12	178.0 7.01	184.0 7.24	2.5 0.10	224.0 8.82	217.0 8.54	0.5 0.02	4.1 0.16	479.6	89.8	0.1350	4.31 9.49

<sup>(4)</sup>Negative value indicates effective center inside cone (inner-ring) backface.  
<sup>(5)</sup>These maximum fillet radii will be cleared by the bearing corners.  
<sup>(6)</sup>Negative value indicates cage extends beyond cone (inner-ring) backface.  
<sup>(7)</sup>Negative value indicates cage that does not extend beyond cone (inner-ring) front face.

Continued on next page.

# TAPERED ROLLER BEARINGS

SINGLE-ROW • Metric



Bearing Dimensions			Load Ratings							Part Number		
Bore d	O.D. D	Width T	Dynamic <sup>(1)</sup>		Factors <sup>(2)</sup>		Dynamic <sup>(3)</sup>		Factors <sup>(2)</sup>		Static C <sub>0</sub>	Assembly Inner/Outer
			C <sub>1</sub>	e	Y	C <sub>90</sub>	C <sub>a90</sub>	K	C <sub>0</sub>			
mm in.	mm in.	mm in.	N lbf			N lbf	N lbf		N lbf			
170.000 6.6929	240.000 9.4488	46.000 1.8110	401000 90200	0.44	1.37	104000 23400	77900 17500	1.34	759000 171000		JM734449/JM734410	
170.000 6.6929	260.000 10.2362	57.000 2.2441	576000 129000	0.44	1.35	149000 33600	114000 25500	1.31	1020000 229000		32034X	
170.000 6.6929	310.000 12.2047	57.000 2.4401	680000 153000	0.44	1.38	176000 39600	131000 29500	1.34	1000000 225000		30234	
170.000 6.6929	310.000 12.2047	91.000 3.5827	1110000 250000	0.44	1.38	288000 64800	215000 48300	1.34	1750000 394000		32234	
180.000 7.0866	250.000 9.8425	45.000 1.7717	403000 90600	0.48	1.25	105000 23500	85900 19300	1.22	795000 179000		32936	
180.000 7.0866	240.000 9.4488	32.000 1.2598	239000 53600	0.48	1.24	61800 13900	51300 11500	1.21	409000 92000		JP18049/JP18010	
180.000 7.0866	250.000 9.8425	47.000 1.8504	409000 92000	0.48	1.25	106000 23800	87200 19600	1.22	786000 177000		JM736149/JM736110	
180.000 7.0866	280.000 11.0236	64.000 2.5197	707000 159000	0.42	1.42	183000 41200	133000 29800	1.38	1240000 280000		32036X	
180.000 7.0866	320.000 12.5984	57.000 2.2441	690000 155000	0.45	1.33	179000 40200	138000 31000	1.30	1050000 235000		30236	
180.000 7.0866	320.000 12.5984	91.000 3.5827	1140000 255000	0.46	1.30	294000 66200	227000 51000	1.27	1900000 427000		32236	
190.000 7.4803	260.000 10.2362	45.000 1.7720	398000 89500	0.48	1.26	103000 23200	84300 19000	1.22	833000 187000		32938	
190.000 7.4803	260.000 10.2362	46.000 1.8110	407000 91500	0.48	1.26	105000 23700	86200 19400	1.22	807000 181000		JM738249/JM738210	
190.000 7.4803	290.000 11.4173	64.000 2.5197	719000 162000	0.44	1.36	186000 41900	141000 31700	1.32	1290000 290000		32038X	
190.000 7.4803	340.000 13.3858	60.000 2.3622	839000 189000	0.44	1.38	217000 48900	162000 36400	1.34	1390000 312000		30238	
190.000 7.4803	340.000 13.3858	97.000 3.8189	1360000 305000	0.44	1.38	352000 79200	262000 59000	1.34	2210000 496000		32238	
200.000 7.8740	280.000 11.0236	51.000 2.0079	530000 119000	0.39	1.52	137000 30900	92800 20900	1.48	1050000 235000		32940	
200.000 7.8740	300.000 11.8110	65.000 2.5591	695000 156000	0.52	1.15	180000 40500	161000 36200	1.12	1280000 287000		JHM840449/JHM840410	

<sup>(1)</sup>Based on 1 x 10<sup>6</sup> revolutions L<sub>10</sub> life, for the ISO life-calculation method.

<sup>(2)</sup>Consult your Timken engineer for instructions on use or review the Timken Engineering Manual on timken.com/catalogs.

<sup>(3)</sup>Based on 90 x 10<sup>6</sup> revolutions L<sub>10</sub> life, for The Timken Company life-calculation method. C<sub>90</sub> and C<sub>a90</sub> are radial and thrust values.

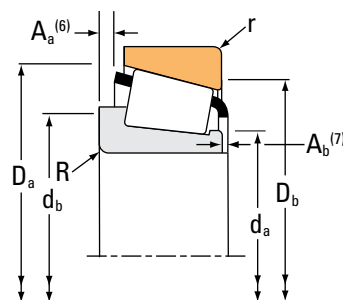
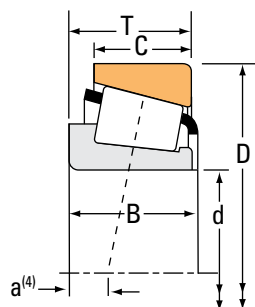
Bearing Dimensions											Geometry Factors			Bearing Weight
Width B	Width C	Eff. Ctr. a <sup>(4)</sup>	Shaft			Housing			Cage		G <sub>1</sub>	G <sub>2</sub>	C <sub>g</sub>	
			Max Shaft Fillet Radius R <sup>(5)</sup>	Backing Shoulder Dia. d <sub>a</sub> d <sub>b</sub>		Max Housing Fillet Radius r <sup>(5)</sup>	Backing Shoulder Dia. D <sub>a</sub> D <sub>b</sub>		A <sub>a</sub> <sup>(6)</sup>	A <sub>b</sub> <sup>(7)</sup>				
mm in.	mm in.	mm in.	mm in.	mm in.	mm in.	mm in.	mm in.	mm in.	mm in.	mm in.			kg lbs.	
44.500 1.7520	37.000 1.4567	5.1 0.20	3.0 0.12	180.0 7.09	185.0 7.28	2.5 0.10	232.0 9.13	222.0 8.74	2.0 0.08	4.8 0.19	548.5	117.5	0.1160	6.24 13.76
57.000 2.2441	43.000 1.6929	-0.3 -0.01	3.0 0.12	187.0 7.36	192.0 7.56	2.5 0.10	249.0 9.80	238.0 9.37	5.6 0.22	3.8 0.15	628.5	142.4	0.1230	10.52 23.18
52.000 2.0472	43.000 1.6929	5.8 0.23	5.0 0.20	191.0 7.52	198.0 7.80	4.0 0.16	288.0 11.34	285.0 11.22	4.3 0.17	6.9 0.27	615.2	89.8	0.1200	17.10 37.70
86.000 3.3858	71.000 2.7953	-14.5 -0.57	5.0 0.20	198.0 7.80	210.0 8.27	4.0 0.16	293.5 11.56	279.0 10.98	8.1 0.32	8.1 0.32	858.1	72.5	0.1360	28.37 62.54
45.000 1.7717	34.000 1.3386	8.9 0.35	2.5 0.10	192.0 7.56	195.0 7.72	2.0 0.08	243.0 9.57	231.0 9.09	4.0 0.15	2.3 0.09	601.8	184.5	0.1236	6.47 14.27
30.000 1.1811	23.000 0.9055	16.00 0.63	3.00 0.12	189.0 7.44	194.0 7.64	3.0 0.12	233.0 9.17	227.0 8.94	2.8 0.11	4.8 0.19	369.2	161.8	0.1040	3.53 7.80
45.000 1.7717	37.000 1.4567	8.9 0.35	3.0 0.12	190.5 7.50	196.0 7.72	2.5 0.10	242.6 9.55	232.0 9.13	2.8 0.11	4.8 0.19	589.4	128.0	0.1230	6.71 14.78
64.000 2.5197	48.000 1.8898	-3.6 -0.14	3.0 0.12	197.0 7.76	203.0 7.99	2.5 0.10	270.0 10.63	256.0 10.08	6.2 0.24	3.8 0.15	760.6	147.5	0.1289	13.98 30.81
52.000 2.0472	43.000 1.6929	8.6 0.34	5.0 0.20	200.0 7.87	209.0 8.23	4.0 0.16	297.0 11.71	294.0 11.57	4.3 0.17	7.1 0.28	676.6	100.2	0.1260	17.95 39.58
86.000 3.3858	71.000 2.7953	-11.4 -0.45	5.0 0.20	210.0 8.27	220.0 8.66	4.0 0.16	303.0 11.93	288.0 11.34	8.6 0.34	8.1 0.32	988.6	103.7	0.1440	30.26 66.71
45.000 1.7717	34.000 1.3386	10.4 0.41	2.5 0.10	201.0 7.91	205.0 8.07	2.0 0.08	251.0 9.88	242.1 9.53	3.3 0.13	3.8 0.15	695.8	184.4	0.1290	6.91 15.23
44.000 1.7323	36.500 1.4370	10.9 0.43	3.3 0.12	200.0 7.87	206.0 8.11	2.5 0.10	252.0 9.92	242.0 9.53	2.5 0.10	4.8 0.19	653.1	146.7	0.1260	6.89 15.20
64.000 2.5197	48.000 1.8898	-0.5 -0.02	3.0 0.12	207.0 8.15	214.0 8.43	2.5 0.10	281.0 11.06	267.0 10.51	6.4 0.25	4.0 0.16	828.7	161.7	0.1344	14.60 32.18
55.000 2.1654	46.000 1.8110	7.1 0.28	5.0 0.20	214.9 8.43	222.0 8.70	4.0 0.16	318.5 12.54	310.0 12.20	3.8 0.15	10.7 0.42	940.6	103.1	0.1390	22.49 49.58
92.000 3.6220	75.000 2.9528	-15.7 -0.62	5.0 0.20	219.0 8.62	230.0 9.05	4.0 0.16	323.0 12.72	305.0 12.01	11.2 0.44	9.9 0.39	1114.6	89.9	0.1480	36.36 80.15
51.000 2.0079	39.000 1.5354	3.0 0.12	3.0 0.12	213.0 8.39	217.0 8.54	2.5 0.10	272.0 10.71	262.0 10.31	4.6 0.18	1.4 0.06	843.3	220.2	0.1298	9.45 20.84
62.000 2.4409	51.000 2.0079	8.1 0.32	3.5 0.14	215.0 8.46	226.0 8.90	2.5 0.10	288.9 11.37	273.0 10.75	3.8 0.15	7.1 0.28	853.6	126.4	0.1430	15.57 34.32

<sup>(4)</sup>Negative value indicates effective center inside cone (inner-ring) backface.  
<sup>(5)</sup>These maximum fillet radii will be cleared by the bearing corners.  
<sup>(6)</sup>Negative value indicates cage extends beyond cone (inner-ring) backface.  
<sup>(7)</sup>Negative value indicates cage that does not extend beyond cone (inner-ring) front face.

Continued on next page.

# TAPERED ROLLER BEARINGS

SINGLE-ROW • Metric



Bearing Dimensions			Load Ratings							Part Number	
Bore d	O.D. D	Width T	Dynamic <sup>(1)</sup>		Factors <sup>(2)</sup>		Dynamic <sup>(3)</sup>		Factors <sup>(2)</sup>	Static C <sub>0</sub>	Assembly Inner/Outer
			C <sub>1</sub>	e	Y	C <sub>90</sub>	C <sub>a90</sub>	K			
mm in.	mm in.	mm in.	N lbf			N lbf	N lbf		N lbf		
200.000 7.8740	310.000 12.2047	70.000 2.7559	847000 191000	0.43	1.39	220000 49400	162000 36400	1.36	1520000 342000	32040X	
200.000 7.8740	360.000 14.1732	64.000 2.5197	891000 200000	0.44	1.38	231000 51900	172000 38700	1.34	1330000 299000	30240	
200.000 7.8740	360.000 14.1732	104.000 4.0945	1390000 312000	0.41	1.48	360000 80900	250000 56300	1.44	2250000 506000	32240	
220.000 8.6614	300.000 11.8110	51.000 2.0079	561000 126000	0.43	1.41	145000 32700	106000 23800	1.37	1090000 245000	32944	
220.000 8.6614	340.000 13.3858	76.000 2.9921	994000 223000	0.43	1.39	258000 57900	190000 42700	1.36	1800000 405000	32044X	
220.000 8.6614	400.000 15.7480	72.000 2.8346	1100000 247000	0.42	1.43	285000 64000	205000 46000	1.39	1560000 350000	30244	
220.000 8.6614	400.000 15.7480	114.000 4.4882	1850000 415000	0.44	1.38	479000 108000	357000 80200	1.34	3010000 677000	32244	
240.000 9.4488	320.000 12.5984	42.000 1.6535	440000 99000	0.46	1.31	114000 25700	89300 20100	1.28	808000 182000	JP24049/JP24010	
240.000 9.4488	320.000 12.5984	51.000 2.0079	571000 128000	0.46	1.31	148000 33300	116000 26100	1.27	1150000 258000	32948	
240.000 9.4488	360.000 14.1732	76.000 2.9921	1030000 232000	0.46	1.31	267000 60100	210000 47200	1.27	1940000 435000	32048X	
240.000 9.4488	440.000 17.3228	127.000 5.0000	2230000 501000	0.44	1.38	578000 130000	430000 96700	1.34	3680000 828000	32248	
260.000 10.2362	360.000 14.1732	63.500 2.5000	829000 186000	0.41	1.48	215000 48300	150000 33600	1.44	1690000 379000	32952	
260.000 10.2362	400.000 15.7480	87.000 3.4252	1320000 298000	0.43	1.38	343000 77100	255000 57400	1.34	2440000 548000	32052X	
260.000 10.2362	480.000 18.8976	137.000 5.3937	2490000 560000	0.43	1.39	646000 145000	476000 107000	1.36	4140000 930000	32252	
280.000 11.0236	380.000 14.9606	63.500 2.5000	850000 191000	0.43	1.39	220000 49500	163000 36700	1.35	1780000 401000	32956	
280.000 11.0236	420.000 16.5354	87.000 3.4252	1380000 309000	0.46	1.31	357000 80200	280000 63000	1.27	2620000 590000	32056X	
300.000 11.8110	420.000 16.5354	76.000 2.9921	1180000 265000	0.39	1.52	306000 68700	207000 464000	1.48	2430000 547000	32960	

<sup>(1)</sup>Based on 1 x 10<sup>6</sup> revolutions L<sub>10</sub> life, for the ISO life-calculation method.

<sup>(2)</sup>Consult your Timken engineer for instructions on use or review the Timken Engineering Manual on timken.com/catalogs.

<sup>(3)</sup>Based on 90 x 10<sup>6</sup> revolutions L<sub>10</sub> life, for The Timken Company life-calculation method. C<sub>90</sub> and C<sub>a90</sub> are radial and thrust values.

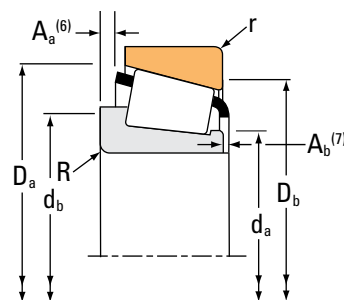
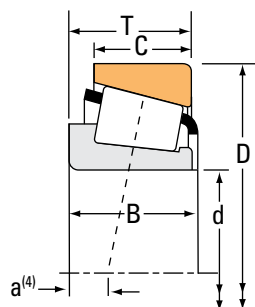
Bearing Dimensions											Geometry Factors			Bearing Weight
Width B	Width C	Eff. Ctr. a <sup>(4)</sup>	Shaft			Housing			Cage		G <sub>1</sub>	G <sub>2</sub>	C <sub>g</sub>	
			Max Shaft Fillet Radius R <sup>(5)</sup>	Backing Shoulder Dia. d <sub>a</sub> d <sub>b</sub>		Max Housing Fillet Radius r <sup>(5)</sup>	Backing Shoulder Dia. D <sub>a</sub> D <sub>b</sub>		A <sub>a</sub> <sup>(6)</sup>	A <sub>b</sub> <sup>(7)</sup>				
mm in.	mm in.	mm in.	mm in.	mm in.	mm in.	mm in.	mm in.	mm in.	mm in.	mm in.			kg lbs.	
70.000 2.7559	53.000 2.0866	-3.3 -0.13	3.0 0.12	220.0 8.66	225.0 8.86	2.5 0.10	297.0 11.69	284.0 11.18	7.4 0.29	5.6 0.22	977.7	113.4	0.1410	18.68 41.18
58.000 2.2835	48.000 1.8898	7.9 0.31	5.0 0.20	227.0 8.94	231.0 9.09	4.0 0.16	335.5 13.21	331.0 13.03	4.6 0.18	9.7 0.38	876.8	106.9	0.1350	25.67 56.60
98.000 3.8583	82.000 3.2283	-20.3 -0.80	5.0 0.20	229.0 9.21	240.0 9.45	4.0 0.16	340.0 13.39	326.0 12.83	15.5 0.61	7.4 0.29	1227.1	110.8	0.1490	42.51 93.72
51.000 2.0079	39.000 1.5354	8.1 0.32	3.0 0.12	232.0 9.13	237.0 9.33	2.5 0.10	290.0 11.42	281.0 11.06	4.7 0.18	3.4 0.14	909.0	153.0	0.1361	9.89 21.81
76.000 2.9921	57.000 2.2441	-3.3 -0.13	4.0 0.16	241.0 9.49	248.0 9.76	3.0 0.12	325.0 12.80	312.0 12.28	10.3 0.40	4.0 0.16	1207.8	127.4	0.1509	23.97 52.86
65.000 2.5591	54.000 2.1260	5.1 0.20	5.1 0.20	245.0 9.65	252.0 9.92	4.0 0.16	371.0 14.61	364.0 14.33	7.9 0.31	9.6 0.38	1012.1	104.0	0.1400	35.25 77.71
108.000 4.2520	90.000 3.5433	-15.0 -0.59	5.0 0.20	251.0 9.88	268.0 10.55	4.0 0.16	379.5 14.94	362.0 14.25	11.0 0.43	7.0 0.28	1607.6	113.5	0.1669	59.41 130.98
39.000 1.5354	30.000 1.1811	19.6 0.77	3.0 0.12	252.0 9.92	257.0 10.12	1.5 0.12	310.0 12.20	304.0 11.97	3.3 0.13	5.8 0.23	804.0	198.2	0.1330	8.20 18.08
51.000 2.0079	39.000 1.5354	14.0 0.55	3.0 0.12	251.0 9.88	258.0 10.16	2.5 0.10	311.5 12.26	300.0 11.81	4.1 0.16	4.3 0.17	1020.3	205.6	0.1450	10.35 22.83
76.000 2.9921	57.000 2.2441	2.2 0.09	4.0 0.16	259.0 10.20	268.0 10.55	3.0 0.12	346.0 13.62	331.0 13.03	10.5 0.41	4.4 0.17	1385.0	145.0	0.1610	25.73 56.71
120.000 4.7244	100.000 3.9370	-17.5 -0.69	5.0 0.20	280.0 11.02	293.0 11.54	4.0 0.16	415.0 16.34	394.0 15.51	10.9 0.43	8.6 0.34	2021.3	103.0	0.1800	81.12 178.85
63.500 2.5000	48.000 1.8898	6.1 0.24	3.0 0.12	275.0 10.83	280.0 11.02	3.0 0.12	347.5 13.68	337.0 13.27	6.1 0.24	4.6 0.18	1503.1	206.8	0.1580	18.60 41.01
87.000 3.4252	65.000 2.5591	-1.5 -0.06	5.0 0.20	284.0 11.18	293.0 11.54	4.0 0.16	382.5 15.06	367.0 14.45	10.9 0.43	4.0 0.16	1752.5	154.0	0.1711	37.84 83.44
130.000 5.1181	106.000 4.1732	-22.8 -0.90	6.0 0.24	306.0 12.05	315.0 12.40	5.0 0.20	454.5 17.89	432.0 17.01	18.2 0.72	9.3 0.37	2419.2	141.7	0.1902	103.96 229.19
63.500 2.5000	48.000 1.8898	11.4 0.45	3.0 0.12	296.0 11.65	300.0 11.81	2.5 0.10	368.0 14.49	356.0 14.02	7.3 0.29	3.4 0.14	1696.5	236.2	0.1680	19.81 43.69
87.000 3.4252	65.000 2.5591	3.8 0.15	5.0 0.20	302.0 11.89	314.0 12.36	4.0 0.16	402.0 15.83	388.1 15.28	11.3 0.44	4.1 0.16	1981.1	175.3	0.1812	40.30 88.84
76.000 2.9921	57.000 2.2441	4.3 0.17	4.0 0.16	318.0 12.52	324.0 12.76	3.0 0.12	405.5 15.96	393.0 15.47	7.9 0.31	6.1 0.24	2228.2	250.1	0.1790	31.23 68.84

<sup>(4)</sup>Negative value indicates effective center inside cone (inner-ring) backface.  
<sup>(5)</sup>These maximum fillet radii will be cleared by the bearing corners.  
<sup>(6)</sup>Negative value indicates cage extends beyond cone (inner-ring) backface.  
<sup>(7)</sup>Negative value indicates cage that does not extend beyond cone (inner-ring) front face.

Continued on next page.

# TAPERED ROLLER BEARINGS

SINGLE-ROW • Metric



Bearing Dimensions			Load Ratings							Part Number	
Bore d	O.D. D	Width T	Dynamic <sup>(1)</sup>		Factors <sup>(2)</sup>		Dynamic <sup>(3)</sup>		Factors <sup>(2)</sup>	Static C <sub>0</sub>	Assembly Inner/Outer
			C <sub>1</sub>	e	Y	C <sub>90</sub>	C <sub>a90</sub>	K			
mm in.	mm in.	mm in.	N lbf			N lbf	N lbf		N lbf		
300.000 11.8110	460.000 18.1102	100.000 3.9370	1730000 389000	0.43	1.38	449000 101000	334000 75100	1.34	3170000 712000	32060X	
300.000 11.8110	540.000 21.2598	149.000 5.8661	3090000 695000	0.43	1.38	802000 180000	597000 134000	1.34	5310000 1190000	32260	
320.000 12.5984	480.000 18.8976	100.000 3.9370	1800000 406000	0.46	1.31	468000 105000	367000 82600	1.27	3420000 768000	32064X	
340.000 13.3858	460.000 18.1102	76.000 2.9921	1220000 274000	0.44	1.37	316000 71000	237000 53200	1.34	2640000 594000	32968	
360.000 14.1732	480.000 18.8976	76.000 2.9921	1250000 281000	0.46	1.31	324000 72800	254000 57100	1.27	2780000 624000	32972	

<sup>(1)</sup>Based on 1 x 10<sup>6</sup> revolutions L<sub>10</sub> life, for the ISO life-calculation method.

<sup>(2)</sup>Consult your Timken engineer for instructions on use or review the Timken Engineering Manual on timken.com/catalogs.

<sup>(3)</sup>Based on 90 x 10<sup>6</sup> revolutions L<sub>10</sub> life, for The Timken Company life-calculation method. C<sub>90</sub> and C<sub>a90</sub> are radial and thrust values.



Bearing Dimensions											Geometry Factors			Bearing Weight
Width B	Width C	Eff. Ctr. a <sup>(4)</sup>	Shaft			Housing			Cage		G <sub>1</sub>	G <sub>2</sub>	C <sub>g</sub>	
			Max Shaft Fillet Radius R <sup>(5)</sup>	Backing Shoulder Dia. d <sub>a</sub> d <sub>b</sub>		Max Housing Fillet Radius r <sup>(5)</sup>	Backing Shoulder Dia. D <sub>a</sub> D <sub>b</sub>		A <sub>a</sub> <sup>(6)</sup>	A <sub>b</sub> <sup>(7)</sup>				
mm in.	mm in.	mm in.	mm in.	mm in.	mm in.	mm in.	mm in.	mm in.	mm in.	mm in.				kg lbs.
<b>100.000</b> 3.9370	<b>74.000</b> 2.9134	<b>-1.8</b> -0.07	<b>5.0</b> 0.20	<b>323.0</b> 12.72	<b>336.0</b> 13.23	<b>4.0</b> 0.16	<b>439.0</b> 17.28	<b>423.0</b> 16.65	<b>11.7</b> 0.46	<b>6.9</b> 0.27	2353.5	203.9	0.1890	<b>56.32</b> 124.17
<b>140.000</b> 5.5118	<b>115.000</b> 4.5276	<b>-17.8</b> -0.70	<b>6.0</b> 0.24	<b>345.0</b> 13.58	<b>359.0</b> 14.13	<b>5.0</b> 0.20	<b>511.0</b> 20.12	<b>483.1</b> 19.02	<b>15.8</b> 0.62	<b>8.9</b> 0.35	3303.4	165.8	0.2120	<b>139.93</b> 308.48
<b>100.000</b> 3.9370	<b>74.000</b> 2.9134	<b>4.3</b> 0.17	<b>5.0</b> 0.20	<b>343.0</b> 13.50	<b>357.0</b> 14.06	<b>4.0</b> 0.16	<b>461.0</b> 18.15	<b>442.0</b> 17.40	<b>13.5</b> 0.53	<b>5.3</b> 0.21	2667.3	201.4	0.1998	<b>59.62</b> 131.44
<b>76.000</b> 2.9921	<b>57.000</b> 2.2441	<b>14.7</b> 0.58	<b>4.0</b> 0.16	<b>359.0</b> 14.13	<b>364.0</b> 14.33	<b>3.0</b> 0.12	<b>446.0</b> 17.56	<b>432.0</b> 17.01	<b>10.5</b> 0.41	<b>4.2</b> 0.17	2703.6	309.5	0.1967	<b>34.46</b> 75.96
<b>76.000</b> 2.9921	<b>57.000</b> 2.2441	<b>20.6</b> 0.81	<b>4.0</b> 0.16	<b>378.0</b> 14.88	<b>385.0</b> 15.16	<b>3.0</b> 0.12	<b>466.0</b> 18.35	<b>451.0</b> 17.76	<b>10.8</b> 0.42	<b>4.2</b> 0.17	2984.5	344.6	0.2061	<b>45.22</b> 79.84

<sup>(4)</sup>Negative value indicates effective center inside cone (inner-ring) backface.  
<sup>(5)</sup>These maximum fillet radii will be cleared by the bearing corners.  
<sup>(6)</sup>Negative value indicates cage extends beyond cone (inner-ring) backface.  
<sup>(7)</sup>Negative value indicates cage that does not extend beyond cone (inner-ring) front face.



### ***TYPE TSF***

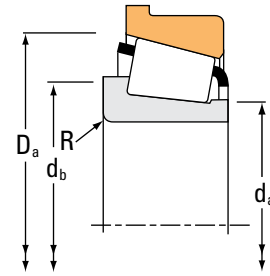
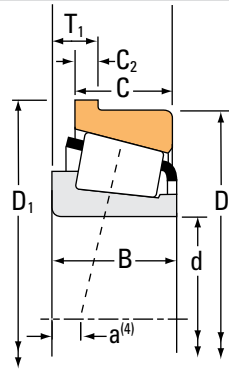
- Type TSF is a single-row bearing with a flange on the outer ring.
- The flange is used for axial location in a housing.
- Through-boring of the housing results in accurately aligned seats.
- The flange is not normally clamped in position.
- Flanged outer rings can be used with any single inner ring from the same series.
- The most commonly specified inner ring part numbers are shown in the tables provided.
- Consult your Timken engineer before making a final bearing selection to help ensure suitability, availability and the most cost-effective application.



# TAPERED ROLLER BEARINGS

## SINGLE-ROW • TYPE TSF

### TYPE TSF



Bearing Dimensions			Load Ratings							Part Number	
Bore d	O.D. D	Width T <sub>1</sub>	Dynamic <sup>(1)</sup>			Dynamic <sup>(3)</sup>			Static C <sub>0</sub>	Inner	Outer
			C <sub>1</sub>	e	Y	C <sub>90</sub>	C <sub>a90</sub>	K			
mm in.	mm in.	mm in.	N lbf			N lbf	N lbf		N lbf		
7.937 0.3125	31.991 1.2595	4.458 0.1755	10800 2430	0.41	1.48	2800 630	1940 437	1.44	9230 2070	A2031	A2126-B
9.525 0.3750	31.991 1.2595	4.458 0.1755	10800 2430	0.41	1.48	2800 630	1940 437	1.44	9230 2070	A2037	A2126-B
**11.987 0.4719	31.991 1.2595	4.458 0.1755	10800 2430	0.41	1.48	2800 630	1940 437	1.44	9230 2070	A2047	A2126-B
12.700 0.5000	34.988 1.3775	4.630 0.1823	13200 2960	0.45	1.32	3410 767	2640 594	1.29	11500 2580	A4050	A4138-B
**14.989 0.5901	34.988 1.3775	4.630 0.1823	13200 2960	0.45	1.32	3410 767	2640 594	1.29	11500 2580	A4059	A4138-B
15.875 0.6250	47.000 1.8504	6.038 0.2377	26700 6010	0.36	1.68	6930 1560	4230 952	1.64	25400 5720	05062	05185-B
15.875 0.6250	42.862 1.6875	6.350 0.2500	31400 7070	0.33	1.81	8150 1830	4620 1040	1.76	29200 6560	17580	17520-B
15.875 0.6250	39.992 1.5745	4.851 0.1910	13400 3020	0.53	1.14	3480 782	3140 705	1.11	12300 2770	A6062	A6157-B
16.993 0.6690	47.000 1.8504	6.038 0.2377	26700 6010	0.36	1.68	6930 1560	4230 952	1.64	25400 5720	05066	05185-B
16.993 0.6690	39.992 1.5745	4.851 0.1910	13400 3020	0.53	1.14	3480 782	3140 705	1.11	12300 2770	A6067	A6157-B
19.050 0.7500	56.896 2.2400	7.455 0.2935	45400 10200	0.31	1.95	11800 2650	6200 1390	1.90	45300 10200	1775	1729-B
19.050 0.7500	53.975 2.1250	10.317 0.4062	55100 12400	0.59	1.02	14300 3210	14400 3250	0.99	42500 9560	21075	21212-B
19.050 0.7500	49.225 1.9380	6.998 0.2755	42800 9630	0.27	2.26	11100 2500	5050 1140	2.20	40500 9100	09067	09195AB
19.050 0.7500	47.000 1.8504	6.038 0.2377	26700 6010	0.36	1.68	6930 1560	4230 952	1.64	25400 5720	05075	05185-B
19.050 0.7500	47.000 1.8504	14.381 0.5662	26700 6010	0.36	1.68	6930 1560	4230 952	1.64	25400 5720	05075X	05185-B
19.050 0.7500	39.992 1.5745	4.851 0.1910	13400 3020	0.53	1.14	3480 782	3140 705	1.11	12300 2770	A6075	A6157-B
*19.987 0.7869	47.000 1.8504	6.048 0.2381	26700 6010	0.36	1.68	6930 1560	4230 952	1.64	25400 5720	05079	05185-B

<sup>(1)</sup>Based on 1 x 10<sup>6</sup> revolutions L<sub>10</sub> life, for the ISO life-calculation method.

<sup>(2)</sup>Consult your Timken engineer for instructions on use or review the Timken Engineering Manual on timken.com/catalogs.

<sup>(3)</sup>Based on 90 x 10<sup>6</sup> revolutions L<sub>10</sub> life, for The Timken Company life-calculation method. C<sub>90</sub> and C<sub>a90</sub> are radial and thrust values.

\*\*For standard class (2 or 4) only, the maximum metric value is a whole millimeter dimension.

Bearing Dimensions									Geometry Factors			Bearing Weight
Width B	Width C	Eff. Ctr. a <sup>(4)</sup>	Outer Ring Flange O.D. D <sub>1</sub>	Flange Width C <sub>2</sub>	Shaft			Housing	G <sub>1</sub>	G <sub>2</sub>	C <sub>g</sub>	
					Max Shaft Fillet Radius R <sup>(5)</sup>	Backing Shoulder Dia.		Backing Shoulder Dia. D <sub>a</sub>				
mm in.	mm in.	mm in.	mm in.	mm in.	mm in.	mm in.	mm in.	mm in.				kg lbs.
10.785 0.4246	7.938 0.3125	-3.0 -0.12	35.166 1.3845	2.388 0.0940	0.5 0.02	12.5 0.49	13.0 0.51	30.0 1.18	1.7	3.2	0.0308	0.05 0.11
10.785 0.4246	7.938 0.3125	-3.0 -0.12	35.166 1.3845	2.388 0.0940	1.3 0.05	13.5 0.53	15.0 0.59	30.0 1.18	1.7	3.2	0.0308	0.05 0.11
10.785 0.4246	7.938 0.3125	-3.0 -0.12	35.166 1.3845	2.388 0.0940	0.8 0.03	15.5 0.61	16.5 0.65	30.0 1.18	1.7	3.2	0.0308	0.04 0.10
10.988 0.4326	8.730 0.3437	-2.5 -0.10	38.062 1.4985	2.362 0.0930	1.3 0.05	17.0 0.67	18.5 0.73	33.5 1.32	2.3	4.1	0.0355	0.05 0.12
10.988 0.4326	8.730 0.3437	-2.5 -0.10	38.062 1.4985	2.362 0.0930	0.8 0.03	19.0 0.75	19.5 0.77	33.5 1.32	2.3	4.1	0.0355	0.04 0.12
14.381 0.5662	11.112 0.4375	-4.1 -0.16	50.861 2.0024	2.769 0.1090	1.5 0.06	21.0 0.83	23.5 0.93	44.5 1.75	5.8	5.5	0.0448	0.14 0.31
16.670 0.6563	13.495 0.5313	-5.8 -0.23	45.936 1.8085	3.175 0.1250	1.5 0.06	21.0 0.83	23.0 0.91	40.5 1.59	5.3	4.5	0.0423	0.12 0.29
11.153 0.4391	9.525 0.3750	-1.5 -0.06	43.066 1.6955	2.362 0.0930	1.3 0.05	20.5 0.81	22.0 0.87	38.0 1.50	2.9	5.6	0.0404	0.09 0.17
14.381 0.5662	11.112 0.4375	-4.1 -0.16	50.861 2.0024	2.769 0.1090	1.5 0.06	22.0 0.87	24.5 0.96	44.5 1.75	5.8	5.5	0.0448	0.14 0.30
11.153 0.4391	9.525 0.3750	-1.5 -0.06	43.066 1.6955	2.362 0.0930	0.8 0.03	21.0 0.83	22.0 0.87	38.0 1.50	2.9	5.6	0.0404	0.09 0.17
19.837 0.7810	15.875 0.6250	-6.9 -0.27	60.757 2.3920	3.962 0.1560	1.5 0.06	25.0 0.98	27.0 1.06	53.0 2.09	10.6	5.4	0.0521	0.27 0.62
21.839 0.8598	15.875 0.6250	-5.8 -0.23	57.841 2.2772	3.967 0.1562	1.5 0.06	26.0 1.03	31.5 1.24	52.0 2.05	7.0	4.1	0.0558	0.26 0.57
19.050 0.7500	14.288 0.5625	-7.4 -0.29	53.081 2.0898	3.251 0.1280	1.3 0.05	24.0 0.94	25.5 1.00	46.5 1.83	8.0	4.0	0.0452	0.18 0.40
14.381 0.5662	11.112 0.4375	-4.1 -0.16	50.861 2.0024	2.769 0.1090	1.3 0.05	23.5 0.93	25.0 0.98	44.5 1.75	5.8	5.5	0.0448	0.13 0.29
14.381 0.5662	11.112 0.4375	-4.1 -0.16	50.861 2.0024	2.769 0.1090	1.5 0.06	23.5 0.93	25.4 1.00	44.5 1.75	5.8	5.5	0.0448	0.13 0.29
11.153 0.4391	9.525 0.3750	-1.5 -0.06	43.066 1.6955	2.362 0.0930	1.0 0.04	23.0 0.91	24.0 0.94	38.0 1.50	2.9	5.6	0.0404	0.08 0.16
14.381 0.5662	11.112 0.4375	-4.1 -0.16	50.861 2.0024	2.769 0.1090	1.5 0.06	24.0 0.94	26.5 1.04	44.5 1.75	5.8	5.5	0.0448	0.13 0.28

<sup>(4)</sup>Negative value indicates effective center inside cone Metric.

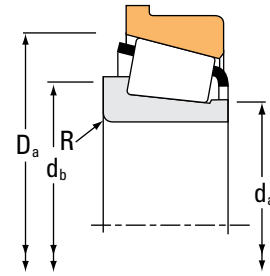
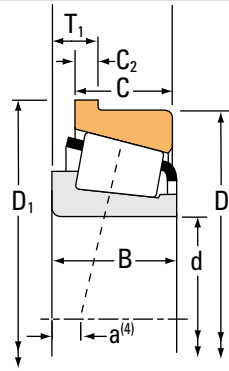
<sup>(5)</sup>These maximum fillet radii will be cleared by the bearing corners.

Continued on next page.

# TAPERED ROLLER BEARINGS

## SINGLE-ROW • TYPE TSF

### TYPE TSF



Bearing Dimensions			Load Ratings							Part Number			
Bore d	O.D. D	Width T <sub>1</sub>	Dynamic <sup>(1)</sup>		Factors <sup>(2)</sup>		Dynamic <sup>(3)</sup>		Factors <sup>(2)</sup>		Static C <sub>0</sub>	Inner	Outer
			C <sub>1</sub>	e	Y	C <sub>90</sub>	C <sub>a90</sub>	K	N	N			
mm in.	mm in.	mm in.	N lbf			N lbf	N lbf		N lbf				
**20.000 0.7874	51.994 2.0470	5.080 0.2000	29100 6540	0.40	1.49	7550 1700	5190 1170	1.45	29600 6650		07079	07204-B	
20.625 0.8120	49.225 1.9380	8.809 0.3468	42800 9630	0.27	2.26	11100 2500	5050 1140	2.20	40500 9100		09081	09195AB	
20.637 0.8125	61.912 2.4375	9.525 0.3750	88600 19900	0.28	2.13	23000 5160	11100 2500	2.07	89800 20200		3660	3620-B	
22.225 0.8750	66.421 2.6150	8.725 0.3435	76600 17200	0.25	2.36	19900 4470	8640 1940	2.30	81700 18400		2684	2631-B	
22.225 0.8750	60.325 2.3750	7.938 0.3125	48400 10900	0.33	1.82	12500 2820	7080 1590	1.77	50200 11300		1975	1931-B	
22.225 0.8750	56.896 2.2400	7.463 0.2938	45400 10200	0.31	1.95	11800 2650	6200 1390	1.90	45300 10200		1755	1729-B	
22.225 0.8750	51.994 2.0470	5.080 0.2000	29100 6540	0.40	1.49	7550 1700	5190 1170	1.45	29600 6650		07087	07204-B	
22.225 0.8750	50.800 2.0000	5.080 0.2000	29100 6540	0.40	1.49	7550 1700	5190 1170	1.45	29600 6650		07087X	07210XB	
22.225 0.8750	50.005 1.9687	6.749 0.2657	29100 6540	0.40	1.49	7550 1700	5190 1170	1.45	29600 6650		07087	07196-B	
23.812 0.9375	72.000 2.8346	7.087 0.2790	58800 13200	0.36	1.67	15200 3420	9390 2110	1.62	60100 13500		26093	26283-B	
23.812 0.9375	56.896 2.2400	7.463 0.2938	45400 10200	0.31	1.95	11800 2650	6200 1390	1.90	45300 10200		1779	1729-B	
23.812 0.9375	51.994 2.0470	5.080 0.2000	29100 6540	0.40	1.49	7550 1700	5190 1170	1.45	29600 6650		07093	07204-B	
24.981 0.9835	51.994 2.0470	5.080 0.2000	29100 6540	0.40	1.49	7550 1700	5190 1170	1.45	29600 6650		07098	07204-B	
24.981 0.9835	50.005 1.9687	6.749 0.2657	29100 6540	0.40	1.49	7550 1700	5190 1170	1.45	29600 6650		07098	07196-B	
25.400 1.0000	72.625 2.8593	11.112 0.4375	94800 21300	0.33	1.80	24600 5520	14000 3140	1.76	102000 22800		3189	3120-B	
25.400 1.0000	72.625 2.8593	12.700 0.5000	82600 18600	0.60	1.00	21400 4820	22100 4960	0.97	64100 14400		41100	41286-B	
25.400 1.0000	72.000 2.8346	7.087 0.2790	58800 13200	0.36	1.67	15200 3420	9390 2110	1.62	60100 13500		26100	26283-B	

<sup>(1)</sup>Based on  $1 \times 10^6$  revolutions  $L_{10}$  life, for the ISO life-calculation method.

<sup>(2)</sup>Consult your Timken engineer for instructions on use or review the Timken Engineering Manual on [timken.com/catalogs](http://timken.com/catalogs).

<sup>(3)</sup>Based on  $90 \times 10^6$  revolutions  $L_{10}$  life, for The Timken Company life-calculation method.  $C_{90}$  and  $C_{a90}$  are radial and thrust values.

\*\*For standard class (2 or 4) only, the maximum metric value is a whole millimeter dimension.

Bearing Dimensions									Geometry Factors			Bearing Weight
Width B	Width C	Eff. Ctr. a <sup>(4)</sup>	Outer Ring Flange O.D. D <sub>1</sub>	Flange Width C <sub>2</sub>	Shaft			Housing	G <sub>1</sub>	G <sub>2</sub>	C <sub>g</sub>	
					Max Shaft Fillet Radius R <sup>(5)</sup>	Backing Shoulder Dia.		Backing Shoulder Dia. D <sub>a</sub>				
mm in.	mm in.	mm in.	mm in.	mm in.	mm in.	mm in.	mm in.	mm in.				kg lbs.
14.260 0.5614	12.700 0.5000	-2.8 -0.11	55.855 2.1990	2.769 0.1090	1.5 0.06	26.0 1.02	27.5 1.08	50.0 1.97	7.6	7.1	0.0509	0.17 0.38
21.539 0.8480	14.288 0.5625	-9.1 -0.36	53.081 2.0898	3.251 0.1280	1.5 0.06	25.4 1.00	27.5 1.08	46.5 1.83	8.0	4.0	0.0452	0.18 0.40
30.417 1.1975	23.812 0.9375	-11.9 -0.47	66.571 2.6209	4.762 0.1875	2.3 0.09	29.5 1.16	33.5 1.32	59.0 2.32	17.0	6.4	0.0592	0.49 1.07
25.433 1.0013	19.050 0.7500	-9.4 -0.37	70.282 2.7670	3.962 0.1560	1.5 0.06	32.0 1.26	34.0 1.34	62.0 2.44	19.3	8.0	0.0598	0.47 1.04
19.355 0.7620	15.875 0.6250	-5.8 -0.23	64.186 2.5270	3.967 0.1562	0.8 0.03	29.5 1.16	30.5 1.20	57.0 2.24	12.5	6.3	0.0565	0.30 0.68
19.837 0.7810	15.875 0.6250	-6.9 -0.27	60.757 2.3920	3.962 0.1560	1.3 0.05	27.5 1.08	29.0 1.14	53.0 2.09	10.6	5.4	0.0521	0.26 0.58
14.260 0.5614	12.700 0.5000	-2.8 -0.11	55.855 2.1990	2.769 0.1090	1.3 0.05	27.0 1.06	28.5 1.12	50.0 1.97	7.6	7.1	0.0509	0.16 0.36
14.260 0.5614	12.700 0.5000	-2.8 -0.11	54.762 2.1560	2.769 0.1090	1.5 0.06	27.0 1.06	29.0 1.14	49.0 1.93	7.6	7.1	0.0509	0.15 0.34
14.260 0.5614	9.525 0.3750	-2.8 -0.11	53.871 2.1209	2.779 0.1094	1.3 0.05	27.0 1.06	28.5 1.12	49.0 1.93	7.6	7.1	0.0509	0.13 0.30
18.923 0.7450	15.875 0.6250	-4.1 -0.16	75.857 2.9865	3.962 0.1560	2.3 0.09	31.0 1.22	35.0 1.38	66.0 2.60	16.1	10.1	0.0630	0.43 0.96
19.837 0.7810	15.875 0.6250	-6.9 -0.27	60.757 2.3920	3.962 0.1560	0.8 0.03	28.5 1.12	29.5 1.16	53.0 2.09	10.6	5.4	0.0521	0.25 0.56
14.260 0.5614	12.700 0.5000	-2.8 -0.11	55.855 2.1990	2.769 0.1090	1.5 0.06	28.5 1.12	30.5 1.20	50.0 1.97	7.6	7.1	0.0509	0.16 0.34
14.260 0.5614	12.700 0.5000	-2.8 -0.11	55.855 2.1990	2.769 0.1090	1.5 0.06	29.0 1.14	31.0 1.22	50.0 1.97	7.6	7.1	0.0509	0.15 0.33
14.260 0.5614	9.525 0.3750	-2.8 -0.11	53.871 2.1209	2.779 0.1094	1.5 0.06	29.0 1.14	31.0 1.22	49.0 1.93	7.6	7.1	0.0509	0.12 0.27
29.997 1.1810	23.812 0.9375	-10.2 -0.40	77.300 3.0433	4.762 0.1875	0.8 0.03	35.0 1.38	35.5 1.40	69.0 2.72	23.4	8.8	0.0697	0.68 1.49
24.257 0.9550	17.462 0.6875	-4.1 -0.16	78.082 3.0741	5.555 0.2187	2.3 0.09	36.5 1.44	41.0 1.61	70.0 2.76	13.0	5.8	0.0686	0.52 1.16
18.923 0.7450	15.875 0.6250	-4.1 -0.16	75.857 2.9865	3.962 0.1560	1.5 0.06	32.5 1.28	34.5 1.36	66.0 2.60	16.1	10.1	0.0630	0.42 0.94

<sup>(4)</sup>Negative value indicates effective center inside cone Metric.

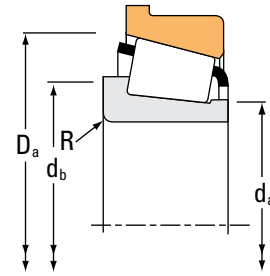
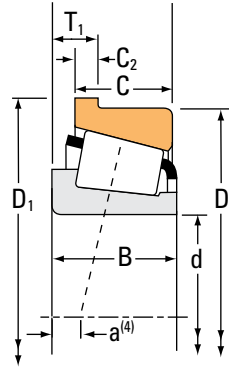
<sup>(5)</sup>These maximum fillet radii will be cleared by the bearing corners.

Continued on next page.

# TAPERED ROLLER BEARINGS

## SINGLE-ROW • TYPE TSF

### TYPE TSF



Bearing Dimensions			Load Ratings							Part Number		
Bore d	O.D. D	Width T <sub>1</sub>	Dynamic <sup>(1)</sup>		Factors <sup>(2)</sup>		Dynamic <sup>(3)</sup>		Factors <sup>(2)</sup>	Static	Inner	Outer
			C <sub>1</sub>	e	Y	C <sub>90</sub>	C <sub>a90</sub>	K	C <sub>0</sub>			
mm in.	mm in.	mm in.	N lbf			N lbf	N lbf		N lbf			
25.400 1.0000	68.262 2.6875	8.730 0.3437	63800 14300	0.42	1.44	16500 3720	11800 2650	1.40	70200 15800		02473	02420-B
25.400 1.0000	66.421 2.6150	8.725 0.3435	76600 17200	0.25	2.36	19900 4470	8640 1940	2.30	81700 18400		2687	2631-B
25.400 1.0000	65.088 2.5625	10.320 0.4063	54600 12300	0.73	0.82	14200 3180	17700 3990	0.80	55800 12500		23100	23256-B
25.400 1.0000	60.325 2.3750	7.938 0.3125	48400 10900	0.33	1.82	12500 2820	7080 1590	1.77	50200 11300		1986	1931-B
25.400 1.0000	58.738 2.3125	7.938 0.3125	48400 10900	0.33	1.82	12500 2820	7080 1590	1.77	50200 11300		1986	1932-B
25.400 1.0000	57.150 2.2500	7.938 0.3125	54500 12300	0.35	1.73	14100 3180	8380 1880	1.69	50100 11300		15578	15520-B
25.400 1.0000	50.800 2.0000	5.080 0.2000	29100 6540	0.40	1.49	7550 1700	5190 1170	1.45	29600 6650		07100-SA	07210XB
26.975 1.0620	60.325 2.3750	7.938 0.3125	48400 10900	0.33	1.82	12500 2820	7080 1590	1.77	50200 11300		1987	1931-B
26.987 1.0625	72.625 2.8593	12.700 0.5000	82600 18600	0.60	1.00	21400 4820	22100 4960	0.97	64100 14400		41106	41286-B
26.987 1.0625	66.421 2.6150	8.725 0.3435	76600 17200	0.25	2.36	19900 4470	8640 1940	2.30	81700 18400		2688	2631-B
28.575 1.1250	72.625 2.8593	11.112 0.4375	94800 21300	0.33	1.80	24600 5520	14000 3140	1.76	102000 22800		3198	3120-B
28.575 1.1250	72.625 2.8593	11.112 0.4375	94800 21300	0.33	1.80	24600 5520	14000 3140	1.76	102000 22800		3192	3120-B
28.575 1.1250	72.625 2.8593	12.700 0.5000	82600 18600	0.60	1.00	21400 4820	22100 4960	0.97	64100 14400		41125	41286-B
28.575 1.1250	72.000 2.8346	7.087 0.2790	69600 15700	0.36	1.67	18100 4060	11100 2500	1.62	60100 13500		26112	26283-B
28.575 1.1250	69.850 2.7500	8.733 0.3438	83700 18800	0.27	2.19	21700 4880	10200 2280	2.14	94400 21200		2578	2523-B
28.575 1.1250	66.421 2.6150	8.725 0.3435	76600 17200	0.25	2.36	19900 4470	8640 1940	2.30	81700 18400		2689	2631-B
28.575 1.1250	60.325 2.3750	7.938 0.3125	48400 10900	0.33	1.82	12500 2820	7080 1590	1.77	50200 11300		1985	1931-B

<sup>(1)</sup>Based on  $1 \times 10^6$  revolutions  $L_{10}$  life, for the ISO life-calculation method.

<sup>(2)</sup>Consult your Timken engineer for instructions on use or review the Timken Engineering Manual on [timken.com/catalogs](http://timken.com/catalogs).

<sup>(3)</sup>Based on  $90 \times 10^6$  revolutions  $L_{10}$  life, for The Timken Company life-calculation method.  $C_{90}$  and  $C_{a90}$  are radial and thrust values.



Bearing Dimensions									Geometry Factors			Bearing Weight
Width B	Width C	Eff. Ctr. a <sup>(4)</sup>	Outer Ring Flange O.D. D <sub>1</sub>	Flange Width C <sub>2</sub>	Shaft			Housing	G <sub>1</sub>	G <sub>2</sub>	C <sub>g</sub>	
					Max Shaft Fillet Radius R <sup>(5)</sup>	Backing Shoulder Dia.		Backing Shoulder Dia. D <sub>a</sub>				
mm in.	mm in.	mm in.	mm in.	mm in.	mm in.	mm in.	mm in.	mm in.				kg lbs.
22.225 0.8750	17.462 0.6875	-5.1 -0.20	72.128 2.8397	3.967 0.1562	0.8 0.03	33.5 1.32	34.5 1.36	65.0 2.56	17.5	8.5	0.0681	0.48 1.06
25.433 1.0013	19.050 0.7500	-9.4 -0.37	70.282 2.7670	3.962 0.1560	1.3 0.05	31.5 1.24	33.5 1.32	62.0 2.44	19.3	8.0	0.0598	0.44 0.99
21.463 0.8450	15.875 0.6250	-2.3 -0.09	68.953 2.7147	3.970 0.1563	1.5 0.06	34.5 1.36	39.0 1.54	63.0 2.48	11.3	6.6	0.0700	0.37 0.83
19.355 0.7620	15.875 0.6250	-5.8 -0.23	64.186 2.5270	3.967 0.1562	1.3 0.05	32.0 1.26	34.0 1.34	57.0 2.24	12.5	6.3	0.0565	0.29 0.64
19.355 0.7620	15.080 0.5937	-5.8 -0.23	62.598 2.4645	3.967 0.1562	1.3 0.05	32.0 1.26	34.0 1.34	56.0 2.20	12.5	6.3	0.0565	0.27 0.59
17.462 0.6875	13.495 0.5313	-5.1 -0.20	61.016 2.4022	3.970 0.1563	1.3 0.05	30.5 1.20	32.5 1.28	60.0 2.36	12.7	10.3	0.0577	0.24 0.52
14.260 0.5614	12.700 0.5000	-2.8 -0.11	54.762 2.1560	2.769 0.1090	3.3 0.13	29.5 1.16	35.0 1.38	49.0 1.93	7.6	7.1	0.0509	0.14 0.30
19.355 0.7620	15.875 0.6250	-5.8 -0.23	64.186 2.5270	3.967 0.1562	0.8 0.03	31.5 1.24	32.5 1.28	57.0 2.24	12.5	6.3	0.0565	0.28 0.62
24.257 0.9550	17.462 0.6875	-4.1 -0.16	78.082 3.0741	5.555 0.2187	2.3 0.09	36.5 1.44	42.0 1.65	70.0 2.76	13.0	5.8	0.0686	0.51 1.13
25.433 1.0013	19.050 0.7500	-9.4 -0.37	70.282 2.7670	3.962 0.1560	1.5 0.06	33.0 1.30	35.0 1.38	62.0 2.44	19.3	8.0	0.0598	0.43 0.96
29.997 1.1810	23.812 0.9375	-10.2 -0.40	77.300 3.0433	4.762 0.1875	1.3 0.05	37.0 1.46	39.0 1.54	69.0 2.72	23.4	8.8	0.0697	0.65 1.42
29.997 1.1810	23.812 0.9375	-10.2 -0.40	77.300 3.0433	4.762 0.1875	3.5 0.14	37.0 1.46	43.5 1.71	69.0 2.72	23.4	8.8	0.0697	0.64 1.41
24.257 0.9550	17.462 0.6875	-4.1 -0.16	78.082 3.0741	5.555 0.2187	4.8 0.19	36.5 1.44	48.0 1.89	70.0 2.76	13.0	5.8	0.0686	0.49 1.09
18.923 0.7450	15.875 0.6250	-4.1 -0.16	75.857 2.9865	3.962 0.1560	1.5 0.06	35.0 1.38	37.0 1.46	66.0 2.60	16.1	10.1	0.0630	0.40 0.90
25.357 0.9983	19.050 0.7500	-8.6 -0.34	73.711 2.9020	3.962 0.1560	2.3 0.09	35.0 1.38	39.0 1.54	66.0 2.60	23.6	9.6	0.0656	0.49 1.09
25.433 1.0013	19.050 0.7500	-9.4 -0.37	70.282 2.7670	3.962 0.1560	1.3 0.05	36.0 1.42	37.5 1.48	62.0 2.44	19.3	8.0	0.0598	0.42 0.93
19.355 0.7620	15.875 0.6250	-5.8 -0.23	64.186 2.5270	3.967 0.1562	0.8 0.03	33.5 1.32	34.0 1.34	57.0 2.24	12.5	6.3	0.0565	0.27 0.59

<sup>(4)</sup>Negative value indicates effective center inside cone (inner-ring) backface.

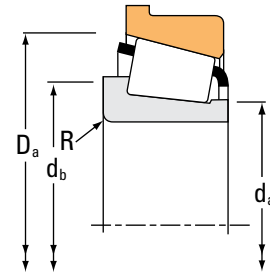
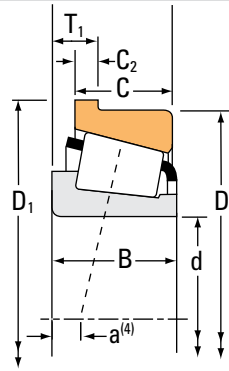
<sup>(5)</sup>These maximum fillet radii will be cleared by the bearing corners.

Continued on next page.

# TAPERED ROLLER BEARINGS

## SINGLE-ROW • TYPE TSF

### TYPE TSF



Bearing Dimensions			Load Ratings							Part Number		
Bore d	O.D. D	Width T <sub>1</sub>	Dynamic <sup>(1)</sup>		Factors <sup>(2)</sup>		Dynamic <sup>(3)</sup>		Factors <sup>(2)</sup>	Static	Inner	Outer
			C <sub>1</sub>	e	Y	C <sub>90</sub>	C <sub>a90</sub>	K	C <sub>0</sub>			
mm in.	mm in.	mm in.	N lbf			N lbf	N lbf		N lbf			
28.575 1.1250	57.150 2.2500	7.938 0.3215	46000 10300	0.35	1.73	11900 2680	7070 1590	1.69	50100 11300		15590	15520-B
29.367 1.1562	66.421 2.6150	8.725 0.3435	76600 17200	0.25	2.36	19900 4470	8640 1940	2.30	81700 18400		2690	2631-B
29.367 1.1562	66.421 2.6150	8.725 0.3435	76600 17200	0.25	2.36	19900 4470	8640 1940	2.30	81700 18400		2691	2631-B
29.987 1.1806	72.000 2.8346	7.087 0.2790	69600 15700	0.36	1.67	18100 4060	11100 2500	1.62	60100 13500		26118	26283-B
29.987 1.1806	68.262 2.6875	8.730 0.3437	63800 14300	0.42	1.44	16500 3720	11800 2650	1.40	70200 15800		02474A	02420-B
**29.987 1.1806	62.000 2.4409	5.270 0.2075	43200 9720	0.38	1.57	11200 2520	7340 1650	1.53	44100 9910		17118	17244-B
30.000 1.1811	72.625 2.8593	11.112 0.4375	94800 21300	0.33	1.80	24600 5520	14000 3140	1.76	102000 22800		3190	3120-B
30.000 1.1811	72.000 2.8346	7.087 0.2790	69600 15700	0.36	1.67	18100 4060	11100 2500	1.62	60100 13500		26118-S	26283-B
30.000 1.1811	69.012 2.7170	7.932 0.3123	54600 12300	0.38	1.57	14200 3180	9260 2080	1.53	61700 13900		14118	14276-B
30.000 1.1811	69.012 2.7170	7.932 0.3123	54600 12300	0.38	1.57	14200 3180	9260 2080	1.53	61700 13900		14117A	14276-B
30.162 1.1875	80.000 3.1496	7.938 0.3125	79500 17900	0.27	2.20	20600 4640	9640 2170	2.14	83400 18700		334	332-B
30.162 1.1875	80.000 3.1496	9.100 0.3583	75200 16900	0.40	1.49	19500 4390	13400 3020	1.45	68900 15500		28118	28315-B
30.162 1.1875	79.375 3.1250	10.320 0.4063	105000 23500	0.37	1.64	27100 6100	17000 3820	1.60	119000 26800		3474	3420-B
30.162 1.1875	72.625 2.8593	11.112 0.4375	94800 21300	0.33	1.80	24600 5520	14000 3140	1.76	102000 22800		3191	3120-B
30.162 1.1875	72.625 2.8593	11.112 0.4375	94800 21300	0.33	1.80	24600 5520	14000 3140	1.76	102000 22800		3187	3120-B
30.162 1.1875	69.850 2.7500	8.733 0.3438	83700 18800	0.27	2.19	21700 4880	10200 2280	2.14	94400 21200		2558	2523-B
30.162 1.1875	64.292 2.5312	8.763 0.3450	60200 13500	0.55	1.10	15600 3510	14600 3280	1.07	71700 16100		M86649	M86611-B

<sup>(1)</sup>Based on  $1 \times 10^6$  revolutions  $L_{10}$  life, for the ISO life-calculation method.

<sup>(2)</sup>Consult your Timken engineer for instructions on use or review the Timken Engineering Manual on [timken.com/catalogs](http://timken.com/catalogs).

<sup>(3)</sup>Based on  $90 \times 10^6$  revolutions  $L_{10}$  life, for The Timken Company life-calculation method.  $C_{90}$  and  $C_{a90}$  are radial and thrust values.

\*\*For standard class (2 or 4) only, the maximum metric value is a whole millimeter dimension.

Bearing Dimensions									Geometry Factors			Bearing Weight
Width B	Width C	Eff. Ctr. a <sup>(4)</sup>	Outer Ring Flange O.D. D <sub>1</sub>	Flange Width C <sub>2</sub>	Shaft			Housing	G <sub>1</sub>	G <sub>2</sub>	C <sub>g</sub>	
					Max Shaft Fillet Radius R <sup>(5)</sup>	Backing Shoulder Dia.		Backing Shoulder Dia. D <sub>a</sub>				
mm in.	mm in.	mm in.	mm in.	mm in.	mm in.	mm in.	mm in.	mm in.				kg lbs.
17.462 0.6875	13.495 0.5313	-5.1 -0.20	61.016 2.4022	3.970 0.1563	3.5 0.14	33.5 1.32	39.5 1.56	60.0 2.36	12.7	10.3	0.0577	0.22 0.47
25.433 1.0013	19.050 0.7500	-9.4 -0.37	70.282 2.7670	3.962 0.1560	3.5 0.14	35.0 1.38	41.0 1.61	62.0 2.44	19.3	8.0	0.0598	0.40 0.91
25.433 1.0013	19.050 0.7500	-9.4 -0.37	70.282 2.7670	3.962 0.1560	0.8 0.03	36.5 1.44	37.5 1.48	62.0 2.44	19.3	8.0	0.0598	0.41 0.92
18.923 0.7450	15.875 0.6250	-4.1 -0.16	75.857 2.9865	3.962 0.1560	1.5 0.06	36.0 1.42	38.0 1.50	66.0 2.60	16.1	10.1	0.0630	0.39 0.88
22.225 0.8750	17.462 0.6875	-5.1 -0.20	72.128 2.8397	3.967 0.1562	0.8 0.03	38.5 1.52	39.5 1.56	65.0 2.56	17.5	8.5	0.0681	0.45 0.99
16.566 0.6522	14.288 0.5625	-3.6 -0.14	65.862 2.5930	3.556 0.1400	1.5 0.06	36.0 1.42	38.5 1.52	59.0 2.32	11.8	7.5	0.0579	0.23 0.53
29.997 1.1810	23.812 0.9375	-10.2 -0.40	77.300 3.0433	4.762 0.1875	3.5 0.14	38.0 1.50	44.5 1.75	69.0 2.72	23.4	8.8	0.0697	0.63 1.37
18.923 0.7450	15.875 0.6250	-4.1 -0.16	75.857 2.9865	3.962 0.1560	1.5 0.06	36.0 1.42	38.0 1.50	66.0 2.60	16.1	10.1	0.0630	0.39 0.88
19.202 0.7560	15.875 0.6250	-4.3 -0.17	72.873 2.8690	3.962 0.1560	0.8 0.03	36.5 1.44	37.0 1.46	65.0 2.56	18.0	13.3	0.0668	0.36 0.82
19.583 0.7710	15.875 0.6250	-4.3 -0.17	72.873 2.8690	3.962 0.1560	3.5 0.14	41.0 1.61	44.0 1.73	65.0 2.56	18.0	13.3	0.0668	0.36 0.82
22.403 0.8820	17.826 0.7018	-6.4 -0.25	84.658 3.3330	4.762 0.1875	0.8 0.03	38.0 1.50	39.0 1.54	77.0 3.03	26.5	13.0	0.0676	0.59 1.32
20.940 0.8244	15.875 0.6250	-4.8 -0.19	83.858 3.3015	3.970 0.1563	1.5 0.06	37.5 1.48	40.0 1.57	73.0 2.87	20.7	12.5	0.0709	0.54 1.21
29.771 1.1721	23.812 0.9375	-8.6 -0.34	84.049 3.3090	4.762 0.1875	0.8 0.03	40.0 1.57	41.0 1.61	76.0 2.99	29.9	11.2	0.0781	0.79 1.73
29.997 1.1810	23.812 0.9375	-10.2 -0.40	77.300 3.0433	4.762 0.1875	3.5 0.14	38.5 1.52	44.5 1.75	69.0 2.72	23.4	8.8	0.0697	0.62 1.37
29.997 1.1810	23.812 0.9375	-10.2 -0.40	77.300 3.0433	4.762 0.1875	0.8 0.03	38.5 1.52	39.0 1.54	69.0 2.72	23.4	8.8	0.0697	0.63 1.38
25.357 0.9983	19.050 0.7500	-8.6 -0.34	73.711 2.9020	3.962 0.1560	2.3 0.09	36.5 1.44	40.0 1.57	66.0 2.60	23.6	9.6	0.0656	0.48 1.06
21.433 0.8438	16.670 0.6563	-3.3 -0.13	70.000 2.7559	4.000 0.1575	1.5 0.06	38.0 1.50	44.0 1.73	63.0 2.48	16.8	7.4	0.0736	0.36 0.79

<sup>(4)</sup>Negative value indicates effective center inside cone Metric.

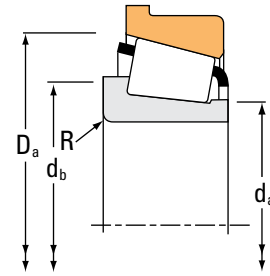
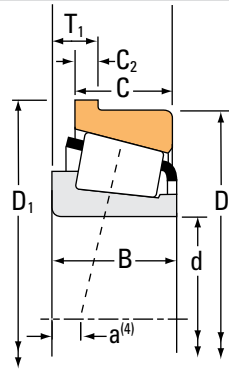
<sup>(5)</sup>These maximum fillet radii will be cleared by the bearing corners.

Continued on next page.

# TAPERED ROLLER BEARINGS

## SINGLE-ROW • TYPE TSF

### TYPE TSF



Bearing Dimensions			Load Ratings							Part Number	
Bore d	O.D. D	Width T <sub>1</sub>	Dynamic <sup>(1)</sup>			Dynamic <sup>(3)</sup>			Static C <sub>0</sub>	Inner	Outer
			C <sub>1</sub>	e	Y	C <sub>90</sub>	C <sub>a90</sub>	K			
mm in.	mm in.	mm in.	N lbf			N lbf	N lbf		N lbf		
30.162 1.1875	62.000 2.4409	5.270 0.2075	43200 9720	0.38	1.57	11200 2520	7340 1650	1.53	44100 9910	17119	17244-B
30.213 1.1895	63.500 2.5000	8.730 0.3437	59900 13500	0.35	1.71	15500 3490	9310 2090	1.67	53900 12100	15118	15250-B
31.750 1.2500	80.000 3.1496	7.938 0.3125	94300 21200	0.27	2.20	24400 5490	11400 2570	2.14	83400 18700	346	332-B
31.750 1.2500	79.375 3.1250	10.320 0.4063	105000 23500	0.37	1.64	27100 6100	17000 3820	1.60	119000 26800	3476	3420-B
31.750 1.2500	72.625 2.8593	11.112 0.4375	94800 21300	0.33	1.80	24600 5520	14000 3140	1.76	102000 22800	3188	3120-B
31.750 1.2500	72.625 2.8593	11.112 0.4375	94800 21300	0.33	1.80	24600 5520	14000 3140	1.76	102000 22800	3199	3120-B
31.750 1.2500	72.625 2.8593	11.112 0.4375	94800 21300	0.33	1.80	24600 5520	14000 3140	1.76	102000 22800	3193	3120-B
31.750 1.2500	69.850 2.7500	8.732 0.3438	83700 18800	0.27	2.19	21700 4880	10200 2280	2.14	94400 21200	2582	2523-B
31.750 1.2500	69.850 2.7500	8.733 0.3438	83700 18800	0.27	2.19	21700 4880	10200 2280	2.14	94400 21200	2580	2523-B
31.750 1.2500	69.012 2.7170	7.932 0.3123	54600 12300	0.38	1.57	14200 3180	9260 2080	1.53	61700 13900	14125A	14276-B
31.750 1.2500	68.262 2.6875	8.730 0.3437	63800 14300	0.42	1.44	16500 3720	11800 2650	1.40	70200 15800	02476	02420-B
31.750 1.2500	68.262 2.6875	8.730 0.3437	63800 14300	0.42	1.44	16500 3720	11800 2650	1.40	70200 15800	02475	02420-B
31.750 1.2500	63.500 2.5000	7.841 0.3087	59900 13500	0.35	1.71	15500 3490	9310 2090	1.67	53900 12100	15123	15250-B
31.750 1.2500	63.500 2.5000	8.730 0.3437	59900 13500	0.35	1.71	15500 3490	9310 2090	1.67	53900 12100	15125	15250-B
31.750 1.2500	59.131 2.3280	6.833 0.2690	46700 10500	0.41	1.46	12100 2720	8550 1920	1.42	44600 10000	LM67047	LM67010-B
31.750 1.2500	59.131 2.3280	6.833 0.2690	46700 10500	0.41	1.46	12100 2720	8550 1920	1.42	44600 10000	LM67048	LM67010-B
31.750 1.2500	58.877 2.3180	6.833 0.2690	46700 10500	0.41	1.46	12100 2720	8550 1920	1.42	44600 10000	LM67048	LM67010-BA

<sup>(1)</sup>Based on  $1 \times 10^6$  revolutions  $L_{10}$  life, for the ISO life-calculation method.

<sup>(2)</sup>Consult your Timken engineer for instructions on use or review the Timken Engineering Manual on [timken.com/catalogs](http://timken.com/catalogs).

<sup>(3)</sup>Based on  $90 \times 10^6$  revolutions  $L_{10}$  life, for The Timken Company life-calculation method.  $C_{90}$  and  $C_{a90}$  are radial and thrust values.

Bearing Dimensions									Geometry Factors			Bearing Weight
Width B	Width C	Eff. Ctr. a <sup>(4)</sup>	Outer Ring Flange O.D. D <sub>1</sub>	Flange Width C <sub>2</sub>	Shaft			Housing	G <sub>1</sub>	G <sub>2</sub>	C <sub>g</sub>	
					Max Shaft Fillet Radius R <sup>(5)</sup>	Backing Shoulder Dia.		Backing Shoulder Dia. D <sub>a</sub>				
mm in.	mm in.	mm in.	mm in.	mm in.	mm in.	mm in.	mm in.	mm in.				kg lbs.
16.566 0.6522	14.288 0.5625	-3.6 -0.14	65.862 2.5930	3.556 0.1400	1.5 0.06	34.5 1.36	37.0 1.46	59.0 2.32	11.8	7.5	0.0579	0.23 0.53
20.638 0.8125	15.875 0.6250	-5.8 -0.23	67.366 2.6522	3.967 0.1562	3.5 0.14	36.5 1.44	43.0 1.69	60.0 2.36	14.6	10.0	0.0606	0.31 0.68
22.403 0.8820	17.826 0.7018	-6.4 -0.25	84.658 3.3330	4.762 0.1875	0.8 0.03	39.5 1.56	40.0 1.57	77.0 3.03	26.5	13.0	0.0676	0.58 1.29
29.771 1.1721	23.812 0.9375	-8.6 -0.34	84.049 3.3090	4.762 0.1875	1.3 0.05	41.0 1.61	43.0 1.69	76.0 2.99	29.9	11.2	0.0781	0.77 1.69
29.997 1.1810	23.812 0.9375	-10.2 -0.40	77.300 3.0433	4.762 0.1875	0.8 0.03	39.5 1.56	40.0 1.57	69.0 2.72	23.4	8.8	0.0697	0.61 1.34
29.997 1.1810	23.812 0.9375	-10.2 -0.40	77.300 3.0433	4.762 0.1875	2.3 0.09	39.5 1.56	43.0 1.69	69.0 2.72	23.4	8.8	0.0697	0.61 1.34
29.997 1.1810	23.812 0.9375	-10.2 -0.40	77.300 3.0433	4.762 0.1875	3.5 0.14	39.5 1.56	45.5 1.79	69.0 2.72	23.4	8.8	0.0697	0.61 1.33
25.357 0.9983	19.050 0.7500	-8.6 -0.34	73.711 2.9020	3.962 0.1560	3.5 0.14	37.5 1.48	44.0 1.73	66.0 2.60	23.6	9.6	0.0656	0.46 1.02
25.357 0.9983	19.050 0.7500	-8.6 -0.34	73.711 2.9020	3.962 0.1560	0.8 0.03	37.5 1.48	38.5 1.52	66.0 2.60	23.6	9.6	0.0656	0.46 1.03
19.583 0.7710	15.875 0.6250	-4.3 -0.17	72.873 2.8690	3.962 0.1560	3.5 0.14	39.0 1.54	45.0 1.77	65.0 2.56	18.0	13.3	0.0668	0.35 0.79
22.225 0.8750	17.462 0.6875	-5.1 -0.20	72.128 2.8397	3.967 0.1562	0.8 0.03	38.5 1.52	39.0 1.54	65.0 2.56	17.5	8.5	0.0681	0.43 0.95
22.225 0.8750	17.462 0.6875	-5.1 -0.20	72.128 2.8397	3.967 0.1562	3.5 0.14	38.5 1.52	44.5 1.75	65.0 2.56	17.5	8.5	0.0681	0.43 0.94
19.050 0.7500	15.875 0.6250	-4.8 -0.19	67.366 2.6522	3.967 0.1562	3.5 0.14	38.0 1.50	44.0 1.73	60.0 2.36	14.6	10.0	0.0606	0.28 0.62
20.638 0.8125	15.875 0.6250	-5.8 -0.23	67.366 2.6522	3.967 0.1562	3.5 0.14	36.5 1.44	42.5 1.67	60.0 2.36	14.6	10.0	0.0606	0.30 0.65
16.764 0.6600	11.811 0.4650	-3.0 -0.12	61.912 2.4375	2.769 0.1090	2.3 0.09	36.0 1.42	40.0 1.57	57.0 2.24	12.8	9.7	0.0612	0.18 0.41
16.764 0.6600	11.811 0.4650	-3.0 -0.12	61.912 2.4375	2.769 0.1090	3.5 0.14	36.0 1.42	42.5 1.67	57.0 2.24	12.8	9.7	0.0612	0.18 0.39
16.764 0.6600	11.811 0.4650	-3.0 -0.12	61.722 2.4300	2.769 0.1090	3.5 0.14	36.0 1.42	42.5 1.67	57.0 2.24	12.8	9.7	0.0612	0.19 0.40

<sup>(4)</sup>Negative value indicates effective center inside cone (inner-ring) backface.

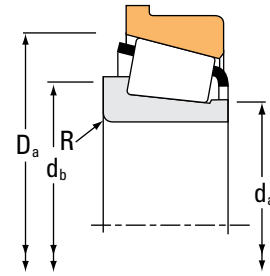
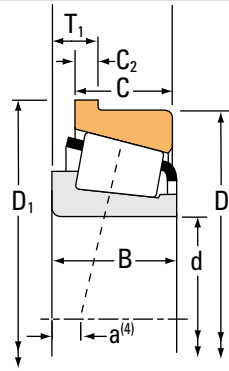
<sup>(5)</sup>These maximum fillet radii will be cleared by the bearing corners.

Continued on next page.

# TAPERED ROLLER BEARINGS

## SINGLE-ROW • TYPE TSF

### TYPE TSF



Bearing Dimensions			Load Ratings							Part Number		
Bore d	O.D. D	Width T <sub>1</sub>	Dynamic <sup>(1)</sup>		Factors <sup>(2)</sup>		Dynamic <sup>(3)</sup>		Factors <sup>(2)</sup>	Static	Inner	Outer
			C <sub>1</sub>	e	Y	C <sub>90</sub>	C <sub>a90</sub>	K	C <sub>0</sub>			
mm in.	mm in.	mm in.	N lbf			N lbf	N lbf		N lbf			
31.750 1.2500	58.738 2.3125	6.736 0.2652	31700 7130	0.47	1.27	8220 1850	6670 1500	1.23	35000 7880		08125	08231-B
32.004 1.2600	72.000 2.8346	7.087 0.2790	58800 13200	0.36	1.67	15200 3420	9390 2110	1.62	60100 13500		26126	26283-B
33.337 1.3125	80.000 3.1496	7.938 0.3125	94300 21200	0.27	2.20	24400 5490	11400 2570	2.14	83400 18700		335-S	332-B
33.337 1.3125	79.375 3.1250	10.320 0.4063	105000 23500	0.37	1.64	27100 6100	17000 3820	1.60	119000 26800		3477	3420-B
33.337 1.3125	79.375 3.1250	10.320 0.4063	105000 23500	0.37	1.64	27100 6100	17000 3820	1.60	119000 26800		3483	3420-B
33.337 1.3125	76.200 3.0000	11.112 0.4375	110000 24800	0.55	1.10	28600 6440	26800 6020	1.07	119000 26700		HM89443	HM89410-B
33.337 1.3125	72.625 2.8593	11.112 0.4375	94800 21300	0.33	1.80	24600 5520	14000 3140	1.76	102000 22800		3197	3120-B
33.337 1.3125	72.625 2.8593	11.112 0.4375	94800 21300	0.33	1.80	24600 5520	14000 3140	1.76	102000 22800		3196	3120-B
33.337 1.3125	72.238 2.8440	8.733 0.3438	56600 12700	0.40	1.49	14700 3300	10100 2270	1.45	65800 14800		16131	16284-B
33.337 1.3125	72.000 2.8346	7.087 0.2790	69600 15700	0.36	1.67	18100 4060	11100 2500	1.62	60100 13500		26131	26283-B
33.337 1.3125	72.000 2.8346	7.087 0.2790	69600 15700	0.36	1.67	18100 4060	11100 2500	1.62	60100 13500		26132	26283-B
33.337 1.3125	69.850 2.7500	8.725 0.3435	83700 18800	0.27	2.19	21700 4880	10200 2280	2.14	94400 21200		2581	2523-B
33.337 1.3125	69.850 2.7500	8.733 0.3438	83700 18800	0.27	2.19	21700 4880	10200 2280	2.14	94400 21200		2585	2523-B
33.338 1.3125	69.012 2.7170	7.938 0.3125	54600 12300	0.38	1.57	14200 3180	9260 2080	1.53	61700 13900		14131	14276-B
33.338 1.3125	69.012 2.7170	7.938 0.3125	54600 12300	0.38	1.57	14200 3180	9260 2080	1.53	61700 13900		14130	14276-B
34.925 1.3750	95.250 3.7500	11.115 0.4376	127000 28500	0.28	2.11	32900 7400	16000 3600	2.05	144000 32400		449	432-B
34.925 1.3750	92.075 3.6250	11.115 0.4376	127000 28500	0.28	2.11	32900 7400	16000 3600	2.05	144000 32400		449	432AB

<sup>(1)</sup>Based on  $1 \times 10^6$  revolutions  $L_{10}$  life, for the ISO life-calculation method.

<sup>(2)</sup>Consult your Timken engineer for instructions on use or review the Timken Engineering Manual on [timken.com/catalogs](http://timken.com/catalogs).

<sup>(3)</sup>Based on  $90 \times 10^6$  revolutions  $L_{10}$  life, for The Timken Company life-calculation method.  $C_{90}$  and  $C_{a90}$  are radial and thrust values.

Bearing Dimensions									Geometry Factors			Bearing Weight
Width B	Width C	Eff. Ctr. a <sup>(4)</sup>	Outer Ring Flange O.D. D <sub>1</sub>	Flange Width C <sub>2</sub>	Shaft			Housing	G <sub>1</sub>	G <sub>2</sub>	C <sub>g</sub>	
					Max Shaft Fillet Radius R <sup>(5)</sup>	Backing Shoulder Dia.		Backing Shoulder Dia. D <sub>a</sub>				
mm in.	mm in.	mm in.	mm in.	mm in.	mm in.	mm in.	mm in.	mm in.				kg lbs.
15.080 0.5937	10.716 0.4219	-1.3 -0.05	62.598 2.4645	2.769 0.1090	1.0 0.04	36.0 1.42	37.5 1.48	57.0 2.24	10.7	10.6	0.0601	0.17 0.38
18.923 0.7450	15.875 0.6250	-4.1 -0.16	75.857 2.9865	3.962 0.1560	1.5 0.06	37.5 1.48	39.5 1.56	66.0 2.60	16.1	10.1	0.0630	0.38 0.85
22.403 0.8820	17.826 0.7018	-6.4 -0.25	84.658 3.3330	4.762 0.1875	0.8 0.03	40.5 1.59	41.0 1.61	77.0 3.03	26.5	13.0	0.0676	0.57 1.26
29.771 1.1721	23.812 0.9375	-8.6 -0.34	84.049 3.3090	4.762 0.1875	3.5 0.14	42.5 1.67	49.0 1.93	76.0 2.99	29.9	11.2	0.0781	0.74 1.64
29.771 1.1721	23.812 0.9375	-8.6 -0.34	84.049 3.3090	4.762 0.1875	0.8 0.03	42.5 1.67	43.0 1.69	76.0 2.99	29.9	11.2	0.0781	0.75 1.65
28.575 1.1250	23.020 0.9063	-5.6 -0.22	80.863 3.1836	4.762 0.1875	0.8 0.03	44.5 1.75	46.5 1.83	75.0 2.95	28.9	9.9	0.0883	0.67 1.49
29.997 1.1810	23.812 0.9375	-10.2 -0.40	77.300 3.0433	4.762 0.1875	0.8 0.03	40.5 1.59	41.5 1.63	69.0 2.72	23.4	8.8	0.0697	0.59 1.30
29.997 1.1810	23.812 0.9375	-10.2 -0.40	77.300 3.0433	4.762 0.1875	3.5 0.14	40.5 1.59	47.0 1.85	69.0 2.72	23.4	8.8	0.0697	0.59 1.29
20.638 0.8125	15.875 0.6250	-4.1 -0.16	76.098 2.9960	3.970 0.1563	3.5 0.14	39.5 1.56	46.0 1.81	69.0 2.72	20.3	14.5	0.0707	0.41 0.91
18.923 0.7450	15.875 0.6250	-4.1 -0.16	75.857 2.9865	3.962 0.1560	3.5 0.14	38.5 1.52	44.5 1.75	66.0 2.60	16.1	10.1	0.0630	0.36 0.81
18.923 0.7450	15.875 0.6250	-4.1 -0.16	75.857 2.9865	3.962 0.1560	1.5 0.06	38.5 1.52	40.5 1.59	66.0 2.60	16.1	10.1	0.0630	0.37 0.82
25.357 0.9983	19.050 0.7500	-8.6 -0.34	73.711 2.9020	3.962 0.1560	0.8 0.03	39.0 1.54	39.5 1.56	66.0 2.60	23.6	9.6	0.0656	0.45 0.99
25.357 0.9983	19.050 0.7500	-8.6 -0.34	73.711 2.9020	3.962 0.1560	3.5 0.14	39.0 1.54	45.0 1.77	66.0 2.60	23.6	9.6	0.0656	0.45 0.98
19.583 0.7710	15.875 0.6250	-4.3 -0.17	72.873 2.8690	3.962 0.1560	0.8 0.03	40.0 1.57	41.0 1.61	65.0 2.56	18.0	13.3	0.0668	0.34 0.77
19.583 0.7710	15.875 0.6250	-4.3 -0.17	72.873 2.8690	3.962 0.1560	3.5 0.14	40.0 1.57	46.5 1.83	65.0 2.56	18.0	13.3	0.0668	0.34 0.78
29.900 1.1772	22.225 0.8750	-9.1 -0.36	100.686 3.9640	5.558 0.2188	0.8 0.03	43.5 1.71	44.0 1.73	87.0 3.43	42.5	11.3	0.0805	1.12 2.47
29.900 1.1772	22.225 0.8750	-9.1 -0.36	97.536 3.8400	5.558 0.2188	0.8 0.03	43.5 1.71	44.0 1.73	87.0 3.43	42.5	11.3	0.0805	1.03 2.28

<sup>(4)</sup>Negative value indicates effective center inside cone (inner-ring) backface.

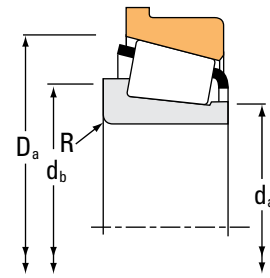
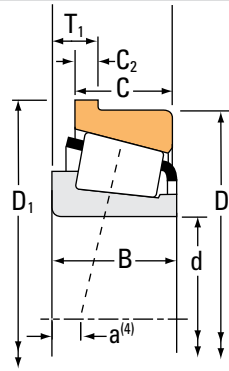
<sup>(5)</sup>These maximum fillet radii will be cleared by the bearing corners.

Continued on next page.

# TAPERED ROLLER BEARINGS

## SINGLE-ROW • TYPE TSF

### TYPE TSF



Bearing Dimensions			Load Ratings							Part Number		
Bore d	O.D. D	Width T <sub>1</sub>	Dynamic <sup>(1)</sup>		Factors <sup>(2)</sup>		Dynamic <sup>(3)</sup>		Factors <sup>(2)</sup>	Static C <sub>0</sub>	Inner	Outer
			C <sub>1</sub>	e	Y	C <sub>90</sub>	C <sub>a90</sub>	K	C <sub>0</sub>			
mm in.	mm in.	mm in.	N lbf			N lbf	N lbf		N lbf			
34.925 1.3750	87.312 3.4375	11.112 0.4375	113000 25500	0.31	1.96	29400 6610	15400 3460	1.91	134000 30100		3581	3525-B
34.925 1.3750	81.755 3.2187	10.320 0.4063	115000 25800	0.27	2.20	29800 6700	13900 3130	2.14	129000 29100		3379	3329-B
34.925 1.3750	80.167 3.1562	10.320 0.4063	115000 25800	0.27	2.20	29800 6700	13900 3130	2.14	129000 29100		3379	3320-B
34.925 1.3750	80.000 3.1496	7.938 0.3125	79500 17900	0.27	2.20	20600 4640	9640 2170	2.14	83400 18700		343	332-B
34.925 1.3750	80.000 3.1496	7.938 0.3125	94300 21200	0.27	2.20	24400 5490	11400 2570	2.14	83400 18700		335	332-B
34.925 1.3750	80.000 3.1496	9.101 0.3583	75200 16900	0.40	1.49	19500 4390	13400 3020	1.45	68900 15500		28137	28315-B
34.925 1.3750	79.375 3.1250	10.320 0.4063	105000 23500	0.37	1.64	27100 6100	17000 3820	1.60	119000 26800		3478	3420-B
34.925 1.3750	79.375 3.1250	10.320 0.4063	105000 23500	0.37	1.64	27100 6100	17000 3820	1.60	119000 26800		3482	3420-B
34.925 1.3750	76.200 3.0000	10.320 0.4063	94700 21300	0.40	1.49	24600 5520	16900 3800	1.45	107000 24100		31593	31520-B
34.925 1.3750	76.200 3.0000	11.112 0.4375	86900 19500	0.30	1.98	22500 5060	11700 2630	1.93	102000 23000		2796	2720-B
34.925 1.3750	76.200 3.0000	11.112 0.4375	86900 19500	0.30	1.98	22500 5060	11700 2630	1.93	102000 23000		2786	2720-B
34.925 1.3750	76.200 3.0000	11.112 0.4375	86900 19500	0.30	1.98	22500 5060	11700 2630	1.93	102000 23000		2793	2720-B
34.925 1.3750	76.200 3.0000	11.112 0.4375	110000 24800	0.55	1.10	28600 6440	26800 6020	1.07	119000 26700	HM89446	HM89410-B	
34.925 1.3750	72.238 2.8440	8.733 0.3438	56600 12700	0.40	1.49	14700 3300	10100 2270	1.45	65800 14800		16137	16284-B
34.925 1.3750	69.012 2.7170	7.938 0.3125	54600 12300	0.38	1.57	14200 3180	9260 2080	1.53	61700 13900		14137A	14276-B
34.925 1.3750	69.012 2.7170	7.938 0.3125	54600 12300	0.38	1.57	14200 3180	9260 2080	1.53	61700 13900		14138A	14276-B
34.976 1.3770	80.000 3.1496	9.101 0.3583	63500 14300	0.40	1.49	16500 3700	11300 2550	1.45	68900 15500		28138	28315-B

<sup>(1)</sup>Based on 1 x 10<sup>6</sup> revolutions L<sub>10</sub> life, for the ISO life-calculation method.

<sup>(2)</sup>Consult your Timken engineer for instructions on use or review the Timken Engineering Manual on timken.com/catalogs.

<sup>(3)</sup>Based on 90 x 10<sup>6</sup> revolutions L<sub>10</sub> life, for The Timken Company life-calculation method. C<sub>90</sub> and C<sub>a90</sub> are radial and thrust values.



Bearing Dimensions									Geometry Factors			Bearing Weight
Width B	Width C	Eff. Ctr. a <sup>(4)</sup>	Outer Ring Flange O.D. D <sub>1</sub>	Flange Width C <sub>2</sub>	Shaft			Housing	G <sub>1</sub>	G <sub>2</sub>	C <sub>g</sub>	
					Max Shaft Fillet Radius R <sup>(5)</sup>	Backing Shoulder Dia.		Backing Shoulder Dia. D <sub>a</sub>				
mm in.	mm in.	mm in.	mm in.	mm in.	mm in.	mm in.	mm in.	mm in.				kg lbs.
30.886 1.2160	23.812 0.9375	-10.2 -0.40	91.986 3.6215	4.750 0.1870	3.5 0.14	43.0 1.69	49.5 1.95	82.0 3.23	39.5	12.5	0.0808	0.95 2.07
30.391 1.1965	23.812 0.9375	-10.9 -0.43	86.413 3.4021	4.762 0.1875	3.5 0.14	41.5 1.63	48.0 1.89	77.0 3.03	34.6	12.1	0.0744	0.79 1.76
30.391 1.1965	23.812 0.9375	-10.9 -0.43	84.826 3.3396	4.762 0.1875	3.5 0.14	41.5 1.63	48.0 1.89	77.0 3.03	34.6	12.1	0.0744	0.77 1.72
22.403 0.8820	17.826 0.7018	-6.4 -0.25	84.658 3.3330	4.762 0.1875	3.5 0.14	41.5 1.63	48.0 1.89	77.0 3.03	26.5	13.0	0.0676	0.55 1.21
22.403 0.8820	17.826 0.7018	-6.4 -0.25	84.658 3.3330	4.762 0.1875	0.8 0.03	41.5 1.63	42.5 1.67	77.0 3.03	26.5	13.0	0.0676	0.55 1.22
20.940 0.8244	15.875 0.6250	-4.8 -0.19	83.858 3.3015	3.970 0.1563	1.5 0.06	41.0 1.61	43.5 1.71	73.0 2.87	20.7	12.5	0.0709	0.50 1.12
29.771 1.1721	23.812 0.9375	-8.6 -0.34	84.049 3.3090	4.762 0.1875	3.5 0.14	43.5 1.71	50.0 1.97	76.0 2.99	29.9	11.2	0.0781	0.72 1.59
29.771 1.1721	23.812 0.9375	-8.6 -0.34	84.049 3.3090	4.762 0.1875	0.8 0.03	43.5 1.71	44.0 1.73	76.0 2.99	29.9	11.2	0.0781	0.73 1.61
28.575 1.1250	23.812 0.9375	-7.6 -0.30	80.863 3.1836	4.762 0.1875	3.5 0.14	43.5 1.71	50.0 1.97	74.0 2.91	26.3	9.1	0.0773	0.64 1.42
25.654 1.0100	19.050 0.7500	-8.1 -0.32	82.550 3.2500	6.350 0.2500	3.5 0.14	41.0 1.61	47.5 1.87	73.0 2.87	28.7	12.2	0.0725	0.59 1.29
25.654 1.0100	19.050 0.7500	-8.1 -0.32	82.550 3.2500	6.350 0.2500	5.0 0.20	41.0 1.61	51.0 2.01	73.0 2.87	28.7	12.2	0.0725	0.58 1.26
25.654 1.0100	19.050 0.7500	-8.1 -0.32	82.550 3.2500	6.350 0.2500	0.8 0.03	41.0 1.61	42.0 1.65	73.0 2.87	28.7	12.2	0.0725	0.59 1.29
28.575 1.1250	23.020 0.9063	-5.6 -0.22	80.863 3.1836	4.762 0.1875	3.5 0.14	44.5 1.75	56.0 2.20	75.0 2.95	28.9	9.9	0.0883	0.65 1.45
20.638 0.8125	15.875 0.6250	-4.1 -0.16	76.098 2.9960	3.970 0.1563	3.5 0.14	40.5 1.59	47.0 1.85	69.0 2.72	20.3	14.5	0.0707	0.40 0.88
19.583 0.7710	15.875 0.6250	-4.3 -0.17	72.873 2.8690	3.962 0.1560	1.5 0.06	41.5 1.63	43.5 1.71	65.0 2.56	18.0	13.3	0.0668	0.33 0.74
19.583 0.7710	15.875 0.6250	-4.3 -0.17	72.873 2.8690	3.962 0.1560	3.5 0.14	41.5 1.63	48.0 1.89	65.0 2.56	18.0	13.3	0.0668	0.33 0.74
20.940 0.8244	15.875 0.6250	-4.8 -0.19	83.858 3.3015	3.970 0.1563	1.5 0.06	41.0 1.61	43.5 1.71	73.0 2.87	20.7	12.5	0.0709	0.50 1.12

<sup>(4)</sup>Negative value indicates effective center inside cone (inner-ring) backface.

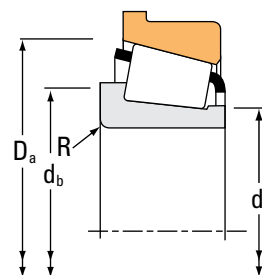
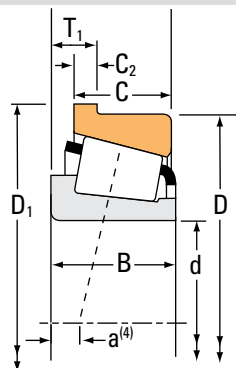
<sup>(5)</sup>These maximum fillet radii will be cleared by the bearing corners.

Continued on next page.

# TAPERED ROLLER BEARINGS

## SINGLE-ROW • TYPE TSF

### TYPE TSF



Bearing Dimensions			Load Ratings							Part Number	
Bore d	O.D. D	Width T <sub>1</sub>	Dynamic <sup>(1)</sup>			Dynamic <sup>(3)</sup>			Static C <sub>0</sub>	Inner	Outer
			C <sub>1</sub>	e	Y	C <sub>90</sub>	C <sub>a90</sub>	K			
mm in.	mm in.	mm in.	N lbf			N lbf	N lbf		N lbf		
34.976 1.3770	72.000 2.8346	6.286 0.2475	50700 11400	0.44	1.35	13100 2960	10000 2250	1.31	57800 13000	19138	19283-B
34.976 1.3770	69.012 2.7170	7.932 0.3123	54600 12300	0.38	1.57	14200 3180	9260 2080	1.53	61700 13900	14139	14276-B
35.000 1.3780	95.250 3.7500	11.115 0.4376	127000 28500	0.28	2.11	32900 7400	16000 3600	2.05	144000 32400	441	432-B
35.000 1.3780	92.075 3.6250	11.115 0.4376	127000 28500	0.28	2.11	32900 7400	16000 3600	2.05	144000 32400	441	432AB
35.000 1.3780	80.000 3.1496	7.938 0.3125	94300 21200	0.27	2.20	24400 5490	11400 2570	2.14	83400 18700	339	332-B
35.000 1.3780	80.000 3.1496	9.250 0.3642	87200 19600	0.31	1.90	22600 5080	12200 2740	1.85	86100 19300	X30307M	Y30307RM
35.000 1.3780	79.375 3.1250	10.320 0.4063	105000 23500	0.37	1.64	27100 6100	17000 3820	1.60	119000 26800	3480	3420-B
35.000 1.3780	72.000 2.8346	6.286 0.2475	50700 11400	0.44	1.35	13100 2960	10000 2250	1.31	57800 13000	19138X	19283-B
35.000 1.3780	68.262 2.6875	7.539 0.2968	50700 11400	0.44	1.35	13100 2960	10000 2250	1.31	57800 13000	19138X	19268-B
36.512 1.4375	88.500 3.4843	13.492 0.5312	99800 22400	0.78	0.77	25900 5810	34600 7770	0.75	88600 19900	44143	44348-B
36.512 1.4375	79.375 3.1250	10.320 0.4063	105000 23500	0.37	1.64	27100 6100	17000 3820	1.60	119000 26800	3479	3420-B
36.512 1.4375	76.200 3.0000	11.112 0.4375	110000 24800	0.55	1.10	28600 6440	26800 6020	1.07	119000 26700	HM89449	HM89410-B
36.512 1.4375	76.200 3.0000	11.112 0.4375	110000 24800	0.55	1.10	28600 6440	26800 6020	1.07	119000 26700	HM89448	HM89410-B
36.512 1.4375	72.238 2.8440	8.733 0.3438	56600 12700	0.40	1.49	14700 3300	10100 2270	1.45	65800 14800	16143	16284-B
36.512 1.4375	72.000 2.8346	6.286 0.2475	50700 11400	0.44	1.35	13100 2960	10000 2250	1.31	57800 13000	19143	19283-B
36.512 1.4375	68.262 2.6875	7.539 0.2968	50700 11400	0.44	1.35	13100 2960	10000 2250	1.31	57800 13000	19143	19268-B
38.100 1.5000	111.125 4.3750	14.288 0.5625	172000 38700	0.30	2.02	44600 10000	22700 5090	1.97	206000 46200	542	532-B

<sup>(1)</sup>Based on 1 x 10<sup>6</sup> revolutions L<sub>10</sub> life, for the ISO life-calculation method.

<sup>(2)</sup>Consult your Timken engineer for instructions on use or review the Timken Engineering Manual on timken.com/catalogs.

<sup>(3)</sup>Based on 90 x 10<sup>6</sup> revolutions L<sub>10</sub> life, for The Timken Company life-calculation method. C<sub>90</sub> and C<sub>a90</sub> are radial and thrust values.

Bearing Dimensions									Geometry Factors			Bearing Weight
Width B	Width C	Eff. Ctr. a <sup>(4)</sup>	Outer Ring Flange O.D. D <sub>1</sub>	Flange Width C <sub>2</sub>	Shaft			Housing	G <sub>1</sub>	G <sub>2</sub>	C <sub>g</sub>	
					Max Shaft Fillet Radius R <sup>(5)</sup>	Backing Shoulder Dia.		Backing Shoulder Dia. D <sub>a</sub>				
mm in.	mm in.	mm in.	mm in.	mm in.	mm in.	mm in.	mm in.	mm in.				kg lbs.
16.520 0.6504	14.288 0.5625	-1.5 -0.06	75.857 2.9865	3.556 0.1400	1.5 0.06	40.5 1.59	42.5 1.67	68.0 2.68	17.5	11.5	0.0694	0.33 0.73
19.583 0.7710	15.875 0.6250	-4.3 -0.17	72.873 2.8690	3.962 0.1560	1.3 0.05	41.5 1.63	43.5 1.71	65.0 2.56	18.0	13.3	0.0668	0.33 0.74
29.900 1.1772	22.225 0.8750	-9.1 -0.36	100.686 3.9640	5.558 0.2188	3.5 0.14	43.5 1.71	50.0 1.97	87.0 3.43	42.5	11.3	0.0805	1.11 2.45
29.900 1.1772	22.225 0.8750	-9.1 -0.36	97.536 3.8400	5.558 0.2188	3.5 0.14	43.5 1.71	50.0 1.97	87.0 3.43	42.5	11.3	0.0805	1.02 2.27
22.403 0.8820	17.826 0.7018	-6.4 -0.25	84.658 3.3330	4.762 0.1875	0.8 0.03	41.5 1.63	42.5 1.67	77.0 3.03	26.5	13.0	0.0676	0.55 1.22
21.000 0.8268	18.000 0.7087	-5.8 -0.23	85.000 3.3464	4.500 0.1772	2.0 0.08	43.5 1.71	46.5 1.83	78.0 3.07	22.9	12.6	0.0675	0.55 1.21
29.771 1.1721	23.812 0.9375	-8.6 -0.34	84.049 3.3090	4.762 0.1875	1.5 0.06	43.5 1.71	46.0 1.81	76.0 2.99	29.9	11.2	0.0781	0.73 1.60
16.520 0.6504	14.288 0.5625	-1.5 -0.06	75.857 2.9865	3.556 0.1400	2.0 0.08	40.5 1.59	43.5 1.71	68.0 2.68	17.5	11.5	0.0694	0.33 0.73
16.520 0.6504	11.908 0.4688	-1.5 -0.06	72.128 2.8397	3.571 0.1406	2.0 0.08	40.5 1.59	43.5 1.71	67.0 2.64	17.5	11.5	0.0694	0.28 0.60
23.698 0.9330	17.462 0.6875	2.3 0.09	93.937 3.6983	5.555 0.2187	2.3 0.09	50.0 1.97	54.0 2.13	86.0 3.39	22.9	8.7	0.0899	0.77 1.68
29.771 1.1721	23.812 0.9375	-8.6 -0.34	84.049 3.3090	4.762 0.1875	0.8 0.03	44.5 1.75	45.5 1.79	76.0 2.99	29.9	11.2	0.0781	0.71 1.56
28.575 1.1250	23.020 0.9063	-5.6 -0.22	80.863 3.1836	4.762 0.1875	3.5 0.14	44.5 1.75	57.0 2.24	75.0 2.95	28.9	9.9	0.0883	0.63 1.41
28.575 1.1250	23.020 0.9063	-5.6 -0.22	80.863 3.1836	4.762 0.1875	0.8 0.03	44.5 1.75	48.5 1.91	75.0 2.95	28.9	9.9	0.0883	0.63 1.41
20.638 0.8125	15.875 0.6250	-4.1 -0.16	76.098 2.9960	3.970 0.1563	3.5 0.14	42.0 1.65	48.5 1.91	69.0 2.72	20.3	14.5	0.0707	0.38 0.84
16.520 0.6504	14.288 0.5625	-1.5 -0.06	75.857 2.9865	3.556 0.1400	1.5 0.06	41.5 1.63	44.0 1.73	68.0 2.68	17.5	11.5	0.0694	0.32 0.71
16.520 0.6504	11.908 0.4688	-1.5 -0.06	72.128 2.8397	3.571 0.1406	1.5 0.06	41.5 1.63	44.0 1.73	67.0 2.64	17.5	11.5	0.0694	0.27 0.58
36.957 1.4550	30.162 1.1875	-12.2 -0.48	117.373 4.6210	6.350 0.2500	3.5 0.14	49.0 1.93	55.0 2.17	100.0 3.94	64.3	16.1	0.0938	2.01 4.43

<sup>(4)</sup>Negative value indicates effective center inside cone (inner-ring) backface.

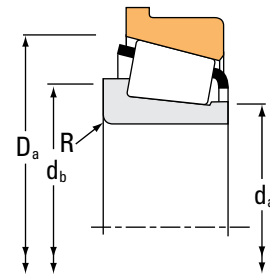
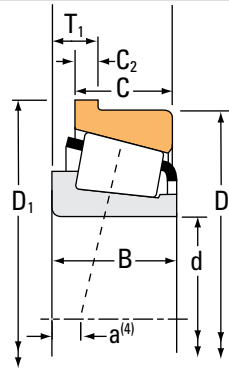
<sup>(5)</sup>These maximum fillet radii will be cleared by the bearing corners.

Continued on next page.

# TAPERED ROLLER BEARINGS

## SINGLE-ROW • TYPE TSF

### TYPE TSF



Bearing Dimensions			Load Ratings							Part Number	
Bore d	O.D. D	Width T <sub>1</sub>	Dynamic <sup>(1)</sup>			Dynamic <sup>(3)</sup>			Static C <sub>0</sub>	Inner	Outer
			C <sub>1</sub>	e	Y	C <sub>90</sub>	C <sub>a90</sub>	K			
mm in.	mm in.	mm in.	N lbf			N lbf	N lbf		N lbf		
38.100 1.5000	95.250 3.7500	11.115 0.4376	127000 28500	0.28	2.11	32900 7400	16000 3600	2.05	144000 32400	440	432-B
38.100 1.5000	95.250 3.7500	11.115 0.4376	127000 28500	0.28	2.11	32900 7400	16000 3600	2.05	144000 32400	444	432-B
38.100 1.5000	92.075 3.6250	11.115 0.4376	127000 28500	0.28	2.11	32900 7400	16000 3600	2.05	144000 32400	440	432AB
38.100 1.5000	92.075 3.6250	11.115 0.4376	127000 28500	0.28	2.11	32900 7400	16000 3600	2.05	144000 32400	444	432AB
38.100 1.5000	88.500 3.4843	13.492 0.5312	99800 22400	0.78	0.77	25900 5810	34600 7770	0.75	88600 19900	44150	44348-B
38.100 1.5000	87.312 3.4375	11.112 0.4375	113000 25500	0.31	1.96	29400 6610	15400 3460	1.91	134000 30100	3580	3525-B
38.100 1.5000	87.312 3.4375	11.112 0.4375	113000 25500	0.31	1.96	29400 6610	15400 3460	1.91	134000 30100	3583	3525-B
38.100 1.5000	81.755 3.2187	10.320 0.4063	115000 25800	0.27	2.20	29800 6700	13900 3130	2.14	129000 29100	3381	3329-B
38.100 1.5000	81.755 3.2187	10.320 0.4063	115000 25800	0.27	2.20	29800 6700	13900 3130	2.14	129000 29100	3387	3329-B
38.100 1.5000	80.167 3.1562	10.320 0.4063	115000 25800	0.27	2.20	29800 6700	13900 3130	2.14	129000 29100	3381	3320-B
38.100 1.5000	80.167 3.1562	10.320 0.4063	115000 25800	0.27	2.20	29800 6700	13900 3130	2.14	129000 29100	3387	3320-B
38.100 1.5000	80.000 3.1496	7.938 0.3125	79500 17900	0.27	2.20	20600 4640	9640 2170	2.14	83400 18700	347	332-B
38.100 1.5000	80.000 3.1496	9.100 0.3583	75200 16900	0.40	1.49	19500 4390	13400 3020	1.45	68900 15500	28150	28315-B
38.100 1.5000	80.000 3.1496	9.101 0.3583	63500 14300	0.40	1.49	16500 3700	11300 2550	1.45	68900 15500	28151	28315-B
38.100 1.5000	79.375 3.1250	10.320 0.4063	105000 23500	0.37	1.64	27100 6100	17000 3820	1.60	119000 26800	3490	3420-B
38.100 1.5000	76.200 3.0000	11.112 0.4375	86900 19500	0.30	1.98	22500 5060	11700 2630	1.93	102000 23000	2788	2720-B
38.100 1.5000	72.238 2.8440	8.733 0.3438	56600 12700	0.40	1.49	14700 3300	10100 2270	1.45	65800 14800	16150	16284-B

<sup>(1)</sup>Based on  $1 \times 10^6$  revolutions  $L_{10}$  life, for the ISO life-calculation method.

<sup>(2)</sup>Consult your Timken engineer for instructions on use or review the Timken Engineering Manual on [timken.com/catalogs](http://timken.com/catalogs).

<sup>(3)</sup>Based on  $90 \times 10^6$  revolutions  $L_{10}$  life, for The Timken Company life-calculation method.  $C_{90}$  and  $C_{a90}$  are radial and thrust values.

Bearing Dimensions									Geometry Factors			Bearing Weight
Width B	Width C	Eff. Ctr. a <sup>(4)</sup>	Outer Ring Flange O.D. D <sub>1</sub>	Flange Width C <sub>2</sub>	Shaft			Housing	G <sub>1</sub>	G <sub>2</sub>	C <sub>g</sub>	
					Max Shaft Fillet Radius R <sup>(5)</sup>	Backing Shoulder Dia.		Backing Shoulder Dia. D <sub>a</sub>				
mm in.	mm in.	mm in.	mm in.	mm in.	mm in.	mm in.	mm in.	mm in.				kg lbs.
29.900 1.1772	22.225 0.8750	-9.1 -0.36	100.686 3.9640	5.558 0.2188	0.8 0.03	45.5 1.79	46.5 1.83	87.0 3.43	42.5	11.3	0.0805	1.08 2.37
29.900 1.1772	22.225 0.8750	-9.1 -0.36	100.686 3.9640	5.558 0.2188	3.5 0.14	45.5 1.79	52.0 2.05	87.0 3.43	42.5	11.3	0.0805	1.07 2.36
29.900 1.1772	22.225 0.8750	-9.1 -0.36	97.536 3.8400	5.558 0.2188	0.8 0.03	45.5 1.79	46.5 1.83	87.0 3.43	42.5	11.3	0.0805	0.99 2.19
29.900 1.1772	22.225 0.8750	-9.1 -0.36	97.536 3.8400	5.558 0.2188	3.5 0.14	45.5 1.79	52.0 2.05	87.0 3.43	42.5	11.3	0.0805	0.98 2.18
23.698 0.9330	17.462 0.6875	2.3 0.09	93.937 3.6983	5.555 0.2187	2.3 0.09	50.8 2.00	55.0 2.17	86.0 3.39	22.9	8.7	0.0899	0.75 1.64
30.886 1.2160	23.812 0.9375	-10.2 -0.40	91.986 3.6215	4.750 0.1870	1.5 0.06	45.5 1.79	48.0 1.89	82.0 3.23	39.5	12.5	0.0808	0.91 1.98
30.886 1.2160	23.812 0.9375	-10.2 -0.40	91.986 3.6215	4.750 0.1870	3.5 0.14	45.5 1.79	52.0 2.05	82.0 3.23	39.5	12.5	0.0808	0.90 1.97
30.391 1.1965	23.812 0.9375	-10.9 -0.43	86.413 3.4021	4.762 0.1875	3.5 0.14	44.5 1.75	51.0 2.01	77.0 3.03	34.6	12.1	0.0744	0.75 1.66
30.391 1.1965	23.812 0.9375	-10.9 -0.43	86.413 3.4021	4.762 0.1875	0.8 0.03	44.5 1.75	45.0 1.77	77.0 3.03	34.6	12.1	0.0744	0.75 1.67
30.391 1.1965	23.812 0.9375	-10.9 -0.43	84.826 3.3396	4.762 0.1875	3.5 0.14	44.5 1.75	51.0 2.01	77.0 3.03	34.6	12.1	0.0744	0.73 1.63
30.391 1.1965	23.812 0.9375	-10.9 -0.43	84.826 3.3396	4.762 0.1875	0.8 0.03	44.5 1.75	45.0 1.77	77.0 3.03	34.6	12.1	0.0744	0.73 1.63
22.403 0.8820	17.826 0.7018	-6.4 -0.25	84.658 3.3330	4.762 0.1875	3.5 0.14	44.0 1.73	50.0 1.97	77.0 3.03	26.5	13.0	0.0676	0.51 1.14
20.940 0.8244	15.875 0.6250	-4.8 -0.19	83.858 3.3015	3.970 0.1563	1.5 0.06	43.5 1.71	45.5 1.79	73.0 2.87	20.7	12.5	0.0709	0.47 1.05
20.940 0.8244	15.875 0.6250	-4.8 -0.19	83.858 3.3015	3.970 0.1563	3.5 0.14	43.5 1.71	50.0 1.97	73.0 2.87	20.7	12.5	0.0709	0.46 1.04
29.771 1.1721	23.812 0.9375	-8.6 -0.34	84.049 3.3090	4.762 0.1875	3.5 0.14	45.5 1.80	52.0 2.05	76.0 2.99	29.9	11.2	0.0781	0.68 1.50
25.654 1.0100	19.050 0.7500	-8.1 -0.32	82.550 3.2500	6.350 0.2500	3.5 0.14	43.5 1.71	50.0 1.97	73.0 2.87	28.7	12.2	0.0725	0.55 1.20
20.638 0.8125	15.875 0.6250	-4.1 -0.16	76.098 2.9960	3.970 0.1563	3.5 0.14	43.0 1.69	49.5 1.95	69.0 2.72	20.3	14.5	0.0707	0.37 0.81

<sup>(4)</sup>Negative value indicates effective center inside cone (inner-ring) backface.

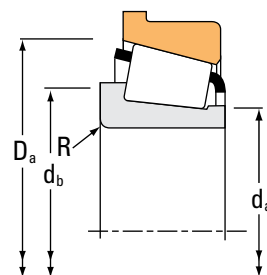
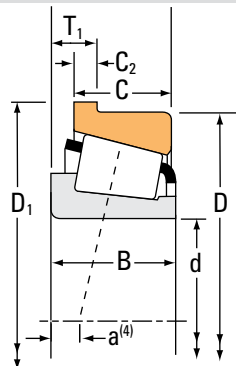
<sup>(5)</sup>These maximum fillet radii will be cleared by the bearing corners.

Continued on next page.

# TAPERED ROLLER BEARINGS

## SINGLE-ROW • TYPE TSF

### TYPE TSF



Bearing Dimensions			Load Ratings							Part Number	
Bore d	O.D. D	Width T <sub>1</sub>	Dynamic <sup>(1)</sup>			Dynamic <sup>(3)</sup>			Static C <sub>0</sub>	Inner	Outer
			C <sub>1</sub>	e	Y	C <sub>90</sub>	C <sub>a90</sub>	K			
mm in.	mm in.	mm in.	N lbf			N lbf	N lbf		N lbf		
38.100 1.5000	72.000 2.8346	6.286 0.2475	50700 11400	0.44	1.35	13100 2960	10000 2250	1.31	57800 13000	19150	19283-B
38.100 1.5000	68.262 2.6875	7.539 0.2968	50700 11400	0.44	1.35	13100 2960	10000 2250	1.31	57800 13000	19150	19268-B
38.100 1.5000	65.088 2.5625	5.944 0.2340	27200 6100	0.35	1.73	7040 1580	4170 938	1.69	33000 7430	13889	13836-B
38.481 1.5150	65.088 2.5625	5.944 0.2340	27200 6100	0.35	1.73	7040 1580	4170 938	1.69	33000 7430	13890	13836-B
39.687 1.5625	120.650 4.7500	16.667 0.6562	207000 46600	0.31	1.91	53800 12100	28900 6510	1.86	244000 54800	620	612-B
39.687 1.5625	88.500 3.4843	13.492 0.5312	99800 22400	0.78	0.77	25900 5810	34600 7770	0.75	88600 19900	44156	44348-B
39.687 1.5625	88.500 3.4843	13.492 0.5312	99800 22400	0.78	0.77	25900 5810	34600 7770	0.75	88600 19900	44158	44348-B
39.688 1.5625	81.755 3.2187	10.320 0.4063	115000 25800	0.27	2.20	29800 6700	13900 3130	2.14	129000 29100	3382	3329-B
39.688 1.5625	81.755 3.2187	10.320 0.4063	115000 25800	0.27	2.20	29800 6700	13900 3130	2.14	129000 29100	3386	3329-B
39.688 1.5625	80.167 3.1562	10.320 0.4063	115000 25800	0.27	2.20	29800 6700	13900 3130	2.14	129000 29100	3382	3320-B
39.688 1.5625	80.167 3.1562	10.320 0.4063	115000 25800	0.27	2.20	29800 6700	13900 3130	2.14	129000 29100	3386	3320-B
40.000 1.5748	95.250 3.7500	11.115 0.4376	127000 28500	0.28	2.11	32900 7400	16000 3600	2.05	144000 32400	442-S	432-B
40.000 1.5748	95.000 3.7402	10.000 0.3937	154000 34600	0.41	1.45	39900 8960	28200 6350	1.41	166000 37300	XGA33210	YSA33210R
40.000 1.5748	92.075 3.6250	11.115 0.4376	127000 28500	0.28	2.11	32900 7400	16000 3600	2.05	144000 32400	442-S	432AB
40.000 1.5748	90.000 3.5433	10.250 0.4035	103000 23200	0.35	1.74	26800 6020	15800 3550	1.69	109000 24600	X30308UM	YSA30308RM
40.000 1.5748	88.500 3.4843	13.492 0.5312	99800 22400	0.78	0.77	25900 5810	34600 7770	0.75	88600 19900	44157	44348-B
40.000 1.5748	85.725 3.3750	11.112 0.4375	124000 27900	0.40	1.49	32200 7240	22200 4980	1.45	148000 33200	3879	3820-B

<sup>(1)</sup>Based on 1 x 10<sup>6</sup> revolutions L<sub>10</sub> life, for the ISO life-calculation method.

<sup>(2)</sup>Consult your Timken engineer for instructions on use or review the Timken Engineering Manual on timken.com/catalogs.

<sup>(3)</sup>Based on 90 x 10<sup>6</sup> revolutions L<sub>10</sub> life, for The Timken Company life-calculation method. C<sub>90</sub> and C<sub>a90</sub> are radial and thrust values.

Bearing Dimensions									Geometry Factors			Bearing Weight
Width B	Width C	Eff. Ctr. a <sup>(4)</sup>	Outer Ring Flange O.D. D <sub>1</sub>	Flange Width C <sub>2</sub>	Shaft			Housing	G <sub>1</sub>	G <sub>2</sub>	C <sub>g</sub>	
					Max Shaft Fillet Radius R <sup>(5)</sup>	Backing Shoulder Dia. d <sub>a</sub>	Backing Shoulder Dia. d <sub>b</sub>	Backing Shoulder Dia. D <sub>a</sub>				
mm in.	mm in.	mm in.	mm in.	mm in.	mm in.	mm in.	mm in.	mm in.				kg lbs.
16.520 0.6504	14.288 0.5625	-1.5 -0.06	75.857 2.9865	3.556 0.1400	1.5 0.06	43.0 1.69	45.0 1.77	68.0 2.68	17.5	11.5	0.0694	0.31 0.68
16.520 0.6504	11.908 0.4688	-1.5 -0.06	72.128 2.8397	3.571 0.1406	1.5 0.06	43.0 1.69	45.0 1.77	67.0 2.64	17.5	11.5	0.0694	0.26 0.55
11.908 0.4688	9.525 0.3750	-0.8 -0.03	68.161 2.6835	2.769 0.1090	1.5 0.06	42.5 1.67	45.0 1.77	63.0 2.48	14.8	23.3	0.0601	0.16 0.37
11.908 0.4688	9.525 0.3750	-0.8 -0.03	68.161 2.6835	2.769 0.1090	0.4 0.02	43.0 1.69	43.0 1.69	63.0 2.48	14.8	23.3	0.0601	0.16 0.36
41.275 1.6250	31.750 1.2500	-14.0 -0.55	127.691 5.0272	7.142 0.2812	0.8 0.03	52.0 2.05	53.0 2.09	110.0 4.33	75.9	16.2	0.0694	2.60 5.74
23.698 0.9330	17.462 0.6875	2.3 0.09	93.937 3.6983	5.555 0.2187	2.3 0.09	50.8 2.00	56.0 2.20	86.0 3.39	22.9	8.7	0.0899	0.73 1.60
23.698 0.9330	17.462 0.6875	2.3 0.09	93.937 3.6983	5.555 0.2187	3.5 0.14	50.8 2.00	58.0 2.28	86.0 3.39	22.9	8.7	0.0899	0.73 1.59
30.391 1.1965	23.812 0.9375	-10.9 -0.43	86.413 3.4021	4.762 0.1875	3.5 0.14	45.5 1.79	52.0 2.05	77.0 3.03	34.6	12.1	0.0744	0.73 1.61
30.391 1.1965	23.812 0.9375	-10.9 -0.43	86.413 3.4021	4.762 0.1875	0.8 0.03	45.5 1.79	46.5 1.83	77.0 3.03	34.6	12.1	0.0744	0.73 1.61
30.391 1.1965	23.812 0.9375	-10.9 -0.43	84.826 3.3396	4.762 0.1875	3.5 0.14	45.5 1.79	52.0 2.05	77.0 3.03	34.6	12.1	0.0744	0.71 1.58
30.391 1.1965	23.812 0.9375	-10.9 -0.43	84.826 3.3396	4.762 0.1875	0.8 0.03	45.5 1.79	46.5 1.83	77.0 3.03	34.6	12.1	0.0744	0.71 1.58
29.900 1.1772	22.225 0.8750	-9.1 -0.36	100.686 3.9640	5.558 0.2188	3.5 0.14	47.0 1.85	54.0 2.13	87.0 3.43	42.5	11.3	0.0805	1.04 2.30
32.000 1.2598	27.000 1.0630	-8.6 -0.34	102.000 4.0157	5.000 0.1968	1.5 0.06	54.0 2.13	56.0 2.20	89.0 3.50	48.4	16.9	0.0957	1.23 2.70
29.900 1.1772	22.225 0.8750	-9.1 -0.36	97.536 3.8400	5.558 0.2188	3.5 0.14	47.0 1.85	54.0 2.13	87.0 3.43	42.5	11.3	0.0805	0.95 2.12
23.000 0.9055	20.000 0.7874	-5.8 -0.23	96.000 3.7795	5.000 0.1969	2.0 0.08	50.0 1.97	53.0 2.09	85.0 3.35	31.6	15.4	0.0775	0.77 1.69
23.698 0.9330	17.462 0.6875	2.3 0.09	93.937 3.6983	5.555 0.2187	2.3 0.09	50.8 2.00	56.0 2.20	86.0 3.39	22.9	8.7	0.0899	0.73 1.59
30.162 1.1875	23.812 0.9375	-8.1 -0.32	89.586 3.5270	4.762 0.1875	0.8 0.03	50.0 1.97	51.0 2.01	83.0 3.27	37.8	13.5	0.0873	0.84 1.86

<sup>(4)</sup>Negative value indicates effective center inside cone (inner-ring) backface.

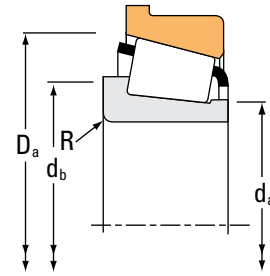
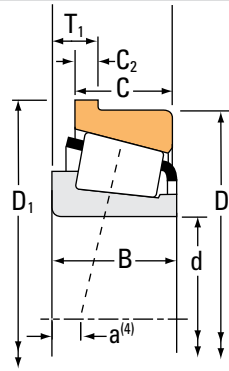
<sup>(5)</sup>These maximum fillet radii will be cleared by the bearing corners.

Continued on next page.

# TAPERED ROLLER BEARINGS

## SINGLE-ROW • TYPE TSF

### TYPE TSF



Bearing Dimensions			Load Ratings							Part Number	
Bore d	O.D. D	Width T <sub>1</sub>	Dynamic <sup>(1)</sup>			Dynamic <sup>(3)</sup>			Static C <sub>0</sub>	Inner	Outer
			C <sub>1</sub>	e	Y	C <sub>90</sub>	C <sub>a90</sub>	K			
mm in.	mm in.	mm in.	N lbf			N lbf	N lbf		N lbf		
40.000 1.5748	80.000 3.1496	7.938 0.3125	94300 21200	0.27	2.20	24400 5490	11400 2570	2.14	83400 18700	344A	332-B
40.000 1.5748	80.000 3.1496	9.100 0.3583	75200 16900	0.40	1.49	19500 4390	13400 3020	1.45	68900 15500	28158	28315-B
41.275 1.6250	98.425 3.8750	16.670 0.6563	119000 26700	0.74	0.81	30800 6920	39000 8760	0.79	104000 23400	53162	53387-B
41.275 1.6250	95.250 3.7500	11.115 0.4376	127000 28500	0.28	2.11	32900 7400	16000 3600	2.05	144000 32400	447	432-B
41.275 1.6250	92.075 3.6250	11.115 0.4376	127000 28500	0.28	2.11	32900 7400	16000 3600	2.05	144000 32400	447	432AB
41.275 1.6250	88.500 3.4843	13.492 0.5312	99800 22400	0.78	0.77	25900 5810	34600 7770	0.75	88600 19900	44162	44348-B
41.275 1.6250	87.312 3.4375	11.099 0.4370	113000 25500	0.31	1.96	29400 6610	15400 3460	1.91	134000 30100	3585	3525-B
41.275 1.6250	87.312 3.4375	11.112 0.4375	113000 25500	0.31	1.96	29400 6610	15400 3460	1.91	134000 30100	3576	3525-B
41.275 1.6250	87.312 3.4375	11.112 0.4375	113000 25500	0.31	1.96	29400 6610	15400 3460	1.91	134000 30100	3577	3525-B
41.275 1.6250	85.725 3.3750	11.112 0.4375	124000 27900	0.40	1.49	32200 7240	22200 4980	1.45	148000 33200	3877	3820-B
41.275 1.6250	81.755 3.2187	10.320 0.4063	115000 25800	0.27	2.20	29800 6700	13900 3130	2.14	129000 29100	3383	3329-B
41.275 1.6250	80.167 3.1562	10.320 0.4063	115000 25800	0.27	2.20	29800 6700	13900 3130	2.14	129000 29100	3383	3320-B
41.275 1.6250	80.000 3.1496	7.938 0.3125	94300 21200	0.27	2.20	24400 5490	11400 2570	2.14	83400 18700	336	332-B
41.275 1.6250	80.000 3.1496	7.938 0.3125	94300 21200	0.27	2.20	24400 5490	11400 2570	2.14	83400 18700	342	332-B
41.275 1.6250	79.375 3.1250	8.732 0.3438	91100 20500	0.32	1.88	23600 5310	12900 2900	1.83	110000 24800	26882	26822-B
41.275 1.6250	76.200 3.0000	7.292 0.2871	48100 10800	0.49	1.23	12500 2800	10400 2340	1.20	55100 12400	11162	11300-B
42.850 1.6870	107.950 4.2500	11.112 0.4375	136000 30500	0.34	1.79	35200 7900	20200 4540	1.74	166000 37200	461	453-B

<sup>(1)</sup>Based on 1 x 10<sup>6</sup> revolutions L<sub>10</sub> life, for the ISO life-calculation method.

<sup>(2)</sup>Consult your Timken engineer for instructions on use or review the Timken Engineering Manual on timken.com/catalogs.

<sup>(3)</sup>Based on 90 x 10<sup>6</sup> revolutions L<sub>10</sub> life, for The Timken Company life-calculation method. C<sub>90</sub> and C<sub>a90</sub> are radial and thrust values.



Bearing Dimensions									Geometry Factors			Bearing Weight
Width B	Width C	Eff. Ctr. a <sup>(4)</sup>	Outer Ring Flange O.D. D <sub>1</sub>	Flange Width C <sub>2</sub>	Shaft			Housing	G <sub>1</sub>	G <sub>2</sub>	C <sub>g</sub>	
					Max Shaft Fillet Radius R <sup>(5)</sup>	Backing Shoulder Dia. d <sub>a</sub>	d <sub>b</sub>	Backing Shoulder Dia. D <sub>a</sub>				
mm in.	mm in.	mm in.	mm in.	mm in.	mm in.	mm in.	mm in.	mm in.				kg lbs.
22.403 0.8820	17.826 0.7018	-6.4 -0.25	84.658 3.3330	4.762 0.1875	0.8 0.03	45.5 1.79	46.0 1.81	77.0 3.03	26.5	13.0	0.0676	0.50 1.11
20.940 0.8244	15.875 0.6250	-4.8 -0.19	83.858 3.3015	3.970 0.1563	1.5 0.06	45.0 1.77	47.5 1.87	73.0 2.87	20.7	12.5	0.0709	0.45 1.01
28.300 1.1142	20.638 0.8125	-0.3 -0.01	104.673 4.1210	6.350 0.2500	1.5 0.06	52.7 2.07	57.0 2.24	92.0 3.62	26.7	9.6	0.0930	1.10 2.44
29.900 1.1772	22.225 0.8750	-9.1 -0.36	100.686 3.9640	5.558 0.2188	3.5 0.14	48.5 1.91	55.0 2.17	87.0 3.43	42.5	11.3	0.0805	1.02 2.26
29.900 1.1772	22.225 0.8750	-9.1 -0.36	97.536 3.8400	5.558 0.2188	3.5 0.14	48.5 1.91	55.0 2.17	87.0 3.43	42.5	11.3	0.0805	0.93 2.07
23.698 0.9330	17.462 0.6875	2.3 0.09	93.937 3.6983	5.555 0.2187	2.3 0.09	50.8 2.00	57.0 2.24	86.0 3.39	22.9	8.7	0.0899	0.71 1.56
30.886 1.2160	23.812 0.9375	-10.2 -0.40	91.986 3.6215	4.750 0.1870	1.5 0.06	48.0 1.89	50.0 1.97	82.0 3.23	39.5	12.5	0.0808	0.86 1.88
30.886 1.2160	23.812 0.9375	-10.2 -0.40	91.986 3.6215	4.750 0.1870	0.8 0.03	48.0 1.89	49.0 1.93	82.0 3.23	39.5	12.5	0.0808	0.86 1.88
30.886 1.2160	23.812 0.9375	-10.2 -0.40	91.986 3.6215	4.750 0.1870	3.5 0.14	48.0 1.89	54.0 2.13	82.0 3.23	39.5	12.5	0.0808	0.85 1.87
30.162 1.1875	23.812 0.9375	-8.1 -0.32	89.586 3.5270	4.762 0.1875	3.5 0.14	50.0 1.98	57.0 2.24	83.0 3.27	37.8	13.5	0.0873	0.82 1.81
30.391 1.1965	23.812 0.9375	-10.9 -0.43	86.413 3.4021	4.762 0.1875	3.5 0.14	47.0 1.85	54.0 2.13	77.0 3.03	34.6	12.1	0.0744	0.70 1.55
30.391 1.1965	23.812 0.9375	-10.9 -0.43	84.826 3.3396	4.762 0.1875	3.5 0.14	47.0 1.85	54.0 2.13	77.0 3.03	34.6	12.1	0.0744	0.68 1.51
22.403 0.8820	17.826 0.7018	-6.4 -0.25	84.658 3.3330	4.762 0.1875	0.8 0.03	46.0 1.81	47.0 1.85	77.0 3.03	26.5	13.0	0.0676	0.49 1.08
22.403 0.8820	17.826 0.7018	-6.4 -0.25	84.658 3.3330	4.762 0.1875	3.5 0.14	46.0 1.81	53.0 2.09	77.0 3.03	26.5	13.0	0.0676	0.48 1.06
25.400 1.0000	19.050 0.7500	-7.4 -0.29	83.241 3.2772	3.970 0.1563	3.5 0.14	47.0 1.85	54.0 2.13	76.0 2.99	32.8	13.3	0.0770	0.55 1.21
17.384 0.6844	14.288 0.5625	-0.8 -0.03	80.863 3.1836	3.571 0.1406	1.5 0.06	46.5 1.83	49.0 1.93	73.0 2.87	19.2	16.0	0.0735	0.35 0.78
29.317 1.1542	22.225 0.8750	-7.1 -0.28	113.386 4.4640	5.558 0.2188	0.8 0.03	53.0 2.09	54.0 2.13	100.0 3.94	58.6	17.1	0.0946	1.40 3.08

<sup>(4)</sup>Negative value indicates effective center inside cone (inner-ring) backface.

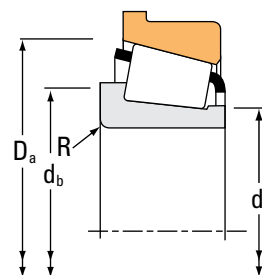
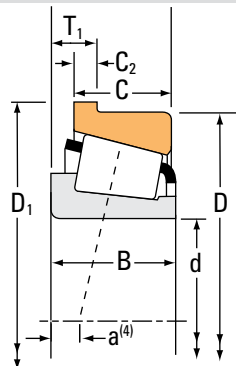
<sup>(5)</sup>These maximum fillet radii will be cleared by the bearing corners.

Continued on next page.

# TAPERED ROLLER BEARINGS

## SINGLE-ROW • TYPE TSF

### TYPE TSF



Bearing Dimensions			Load Ratings							Part Number		
Bore d	O.D. D	Width T <sub>1</sub>	Dynamic <sup>(1)</sup>		Factors <sup>(2)</sup>		Dynamic <sup>(3)</sup>		Factors <sup>(2)</sup>	Static C <sub>0</sub>	Inner	Outer
			C <sub>1</sub>	e	Y	C <sub>90</sub>	C <sub>a90</sub>	K	C <sub>0</sub>			
mm in.	mm in.	mm in.	N lbf			N lbf	N lbf		N lbf			
42.862 1.6875	87.312 3.4375	11.112 0.4375	113000 25500	0.31	1.96	29400 6610	15400 3460	1.91	134000 30100		3579	3525-B
42.862 1.6875	85.000 3.3465	9.525 0.3750	93300 21000	0.35	1.73	24200 5440	14300 3220	1.69	117000 26200		2973	2924-B
42.862 1.6875	83.058 3.2700	8.733 0.3438	90500 20300	0.33	1.79	23500 5270	13500 3020	1.74	111000 24900		25576	25521-B
42.875 1.6880	80.000 3.1496	7.938 0.3125	94300 21200	0.27	2.20	24400 5490	11400 2570	2.14	83400 18700		342-S	332-B
43.000 1.6929	80.000 3.1496	7.938 0.3125	94300 21200	0.27	2.20	24400 5490	11400 2570	2.14	83400 18700		342X	332-B
44.450 1.7500	127.000 5.0000	17.462 0.6875	306000 68800	0.30	2.01	79300 17800	40500 9110	1.96	370000 83300		6277	6220-B
44.450 1.7500	120.650 4.7500	16.574 0.6525	207000 46600	0.31	1.91	53800 12100	28900 6510	1.86	244000 54800		615	612-B
44.450 1.7500	108.966 4.2900	14.288 0.5625	202000 45500	0.40	1.49	52400 11800	36100 8110	1.45	202000 45400		59175	59429-B
44.450 1.7500	107.950 4.2500	11.115 0.4376	161000 36100	0.34	1.79	41700 9370	23900 5380	1.74	166000 37200		460	453-B
44.450 1.7500	101.600 4.0000	11.908 0.4688	157000 35400	0.40	1.50	40800 9170	28000 6290	1.46	155000 35000		49576	49520-B
44.450 1.7500	98.425 3.8750	16.670 0.6563	119000 26700	0.74	0.81	30800 6920	39000 8760	0.79	104000 23400		53176	53387-B
44.450 1.7500	95.250 3.7500	11.115 0.4376	127000 28500	0.28	2.11	32900 7400	16000 3600	2.05	144000 32400		435	432-B
44.450 1.7500	95.250 3.7500	11.115 0.4376	127000 28500	0.28	2.11	32900 7400	16000 3600	2.05	144000 32400		438	432-B
44.450 1.7500	92.075 3.6250	11.115 0.4376	127000 28500	0.28	2.11	32900 7400	16000 3600	2.05	144000 32400		435	432AB
44.450 1.7500	92.075 3.6250	11.115 0.4376	127000 28500	0.28	2.11	32900 7400	16000 3600	2.05	144000 32400		438	432AB
44.450 1.7500	87.312 3.4375	11.112 0.4375	113000 25500	0.31	1.96	29400 6610	15400 3460	1.91	134000 30100		3578	3525-B
44.450 1.7500	85.000 3.3465	7.938 0.3125	97000 21800	0.31	1.96	25100 5650	13200 2960	1.91	88800 20000		355	354-B

<sup>(1)</sup>Based on  $1 \times 10^6$  revolutions  $L_{10}$  life, for the ISO life-calculation method.

<sup>(2)</sup>Consult your Timken engineer for instructions on use or review the Timken Engineering Manual on [timken.com/catalogs](http://timken.com/catalogs).

<sup>(3)</sup>Based on  $90 \times 10^6$  revolutions  $L_{10}$  life, for The Timken Company life-calculation method.  $C_{90}$  and  $C_{a90}$  are radial and thrust values.

Bearing Dimensions									Geometry Factors			Bearing Weight
Width B	Width C	Eff. Ctr. a <sup>(4)</sup>	Outer Ring Flange O.D. D <sub>1</sub>	Flange Width C <sub>2</sub>	Shaft			Housing	G <sub>1</sub>	G <sub>2</sub>	C <sub>g</sub>	
					Max Shaft Fillet Radius R <sup>(5)</sup>	Backing Shoulder Dia. d <sub>a</sub>	Backing Shoulder Dia. d <sub>b</sub>	Backing Shoulder Dia. D <sub>a</sub>				
mm in.	mm in.	mm in.	mm in.	mm in.	mm in.	mm in.	mm in.	mm in.				kg lbs.
30.886 1.2160	23.812 0.9375	-10.2 -0.40	91.986 3.6215	4.750 0.1870	3.5 0.14	49.5 1.95	56.0 2.20	82.0 3.23	39.5	12.5	0.0808	0.83 1.81
25.608 1.0082	20.638 0.8125	-6.4 -0.25	89.764 3.5340	4.762 0.1875	3.5 0.14	49.5 1.95	56.0 2.20	82.0 3.23	38.2	15.7	0.0832	0.69 1.53
25.400 1.0000	19.050 0.7500	-6.4 -0.25	86.919 3.4220	3.970 0.1563	3.5 0.14	49.0 1.93	55.0 2.17	80.0 3.15	35.2	14.3	0.0801	0.60 1.32
22.403 0.8820	17.826 0.7018	-6.4 -0.25	84.658 3.3330	4.762 0.1875	3.5 0.14	47.5 1.87	54.0 2.13	77.0 3.03	26.5	13.0	0.0676	0.46 1.02
22.403 0.8820	17.826 0.7018	-6.1 -0.24	84.658 3.3330	4.762 0.1875	3.5 0.14	48.0 1.89	55.0 2.17	77.0 3.03	26.5	13.0	0.0676	0.46 1.03
52.388 2.0625	41.275 1.6250	-19.6 -0.77	134.925 5.3120	7.938 0.3125	3.5 0.14	60.0 2.36	67.0 2.64	117.0 4.61	103.1	18.7	0.0757	3.68 8.09
41.275 1.6250	31.750 1.2500	-14.0 -0.55	127.691 5.0272	7.142 0.2812	3.5 0.14	56.0 2.20	62.0 2.44	110.0 4.33	75.9	16.2	0.0694	2.49 5.50
36.512 1.4375	26.988 1.0625	-9.7 -0.38	115.214 4.5360	6.350 0.2500	3.5 0.14	56.0 2.20	63.0 2.48	101.0 3.98	57.3	15.2	0.0999	1.71 3.79
29.317 1.1542	22.225 0.8750	-7.1 -0.28	113.386 4.4640	5.558 0.2188	3.5 0.14	54.0 2.13	60.0 2.36	100.0 3.94	58.6	17.1	0.0946	1.37 3.01
31.750 1.2500	25.400 1.0000	-7.1 -0.28	107.056 4.2148	5.558 0.2188	0.8 0.03	54.0 2.13	55.0 2.17	98.0 3.86	49.1	16.8	0.0946	1.31 2.88
28.300 1.1142	20.638 0.8125	-0.3 -0.01	104.673 4.1210	6.350 0.2500	1.3 0.05	52.7 2.07	59.0 2.32	92.0 3.62	26.7	9.6	0.0930	1.05 2.33
29.900 1.1772	22.225 0.8750	-9.1 -0.36	100.686 3.9640	5.558 0.2188	0.8 0.03	51.0 2.01	52.0 2.05	87.0 3.43	42.5	11.3	0.0805	0.98 2.16
29.900 1.1772	22.225 0.8750	-9.1 -0.36	100.686 3.9640	5.558 0.2188	3.5 0.14	51.0 2.01	57.0 2.24	87.0 3.43	42.5	11.3	0.0805	0.97 2.15
29.900 1.1772	22.225 0.8750	-9.1 -0.36	97.536 3.8400	5.558 0.2188	0.8 0.03	51.0 2.01	52.0 2.05	87.0 3.43	42.5	11.3	0.0805	0.89 1.98
29.900 1.1772	22.225 0.8750	-9.1 -0.36	97.536 3.8400	5.558 0.2188	3.5 0.14	51.0 2.01	57.0 2.24	87.0 3.43	42.5	11.3	0.0805	0.88 1.96
30.886 1.2160	23.812 0.9375	-10.2 -0.40	91.986 3.6215	4.750 0.1870	3.5 0.14	51.0 2.01	57.0 2.24	82.0 3.23	39.5	12.5	0.0808	0.80 1.75
21.692 0.8540	17.462 0.6875	-4.8 -0.19	89.659 3.5299	4.762 0.1875	2.3 0.09	50.0 1.97	54.0 2.13	82.0 3.23	30.0	12.2	0.0732	0.54 1.19

<sup>(4)</sup>Negative value indicates effective center inside cone (inner-ring) backface.

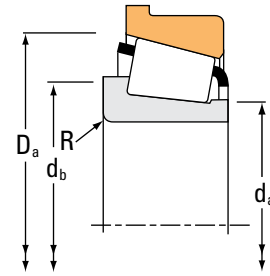
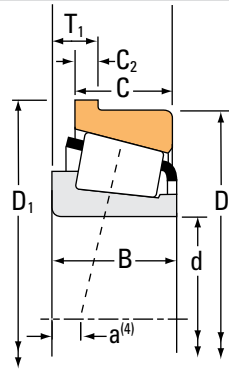
<sup>(5)</sup>These maximum fillet radii will be cleared by the bearing corners.

Continued on next page.

# TAPERED ROLLER BEARINGS

## SINGLE-ROW • TYPE TSF

### TYPE TSF



Bearing Dimensions			Load Ratings							Part Number	
Bore d	O.D. D	Width T <sub>1</sub>	Dynamic <sup>(1)</sup>			Dynamic <sup>(3)</sup>			Static C <sub>0</sub>	Inner	Outer
			C <sub>1</sub>	Factors <sup>(2)</sup> e Y		C <sub>90</sub>	Factors <sup>(2)</sup> K				
mm in.	mm in.	mm in.	N lbf			N lbf	N lbf		N lbf		
44.450 1.7500	85.000 3.3465	7.938 0.3125	97000 21800	0.31	1.96	25100 5650	13200 2960	1.91	88800 20000	355X	354-B
44.450 1.7500	83.058 3.2700	8.733 0.3438	90500 20300	0.33	1.79	23500 5270	13500 3020	1.74	111000 24900	25580	25521-B
44.450 1.7500	79.375 3.1250	7.539 0.2968	52000 11700	0.37	1.60	13500 3030	8630 1940	1.56	61300 13800	18685	18620-B
44.450 1.7500	76.992 3.0312	9.126 0.3593	49500 11100	0.51	1.19	12800 2890	11100 2500	1.15	58100 13100	12175	12303-B
44.450 1.7500	73.025 2.8750	6.350 0.2500	57000 12800	0.32	1.88	14800 3320	8060 1810	1.83	78300 17600	L102849	L102810-B
44.450 1.7500	71.438 2.8125	5.969 0.2350	36100 8110	0.31	1.97	9350 2100	4890 1100	1.91	43600 9790	LL103049	LL103010-B
44.983 1.7710	93.264 3.6718	11.112 0.4375	122000 27500	0.34	1.77	31700 7120	18300 4120	1.73	153000 34300	3776	3720-B
44.983 1.7710	83.058 3.2700	8.733 0.3438	90500 20300	0.33	1.79	23500 5270	13500 3020	1.74	111000 24900	25584	25521-B
45.000 1.7717	100.000 3.9370	10.250 0.4035	129000 29000	0.35	1.74	33500 7530	19800 4450	1.69	139000 31300	X30309M	Y30309RM
45.000 1.7717	90.000 3.5433	8.887 0.3499	102000 22900	0.32	1.88	26400 5930	14400 3250	1.83	95800 21500	367	362-B
45.000 1.7717	85.000 3.3465	7.938 0.3125	97000 21800	0.31	1.96	25100 5650	13200 2960	1.91	88800 20000	358	354-B
45.000 1.7717	80.000 3.1496	10.000 0.3937	113000 25300	0.38	1.57	29200 6570	19200 4310	1.52	119000 26800	X33109	Y33109R
45.000 1.7717	75.000 2.9528	8.000 0.3150	78700 17700	0.39	1.53	20400 4590	13700 3080	1.49	84300 19000	X32009X	Y32009XR
45.237 1.7810	87.312 3.4375	11.112 0.4375	113000 25500	0.31	1.96	29400 6610	15400 3460	1.91	134000 30100	3586	3525-B
45.618 1.7960	83.058 3.2700	8.733 0.3438	90500 20300	0.33	1.79	23500 5270	13500 3020	1.74	111000 24900	25590	25521-B
46.037 1.8125	95.250 3.7500	11.115 0.4376	127000 28500	0.28	2.11	32900 7400	16000 3600	2.05	144000 32400	436	432-B
46.037 1.8125	92.075 3.6250	11.115 0.4376	127000 28500	0.28	2.11	32900 7400	16000 3600	2.05	144000 32400	436	432AB

<sup>(1)</sup>Based on  $1 \times 10^6$  revolutions  $L_{10}$  life, for the ISO life-calculation method.

<sup>(2)</sup>Consult your Timken engineer for instructions on use or review the Timken Engineering Manual on [timken.com/catalogs](http://timken.com/catalogs).

<sup>(3)</sup>Based on  $90 \times 10^6$  revolutions  $L_{10}$  life, for The Timken Company life-calculation method.  $C_{90}$  and  $C_{a90}$  are radial and thrust values.

Bearing Dimensions									Geometry Factors			Bearing Weight
Width B	Width C	Eff. Ctr. a <sup>(4)</sup>	Outer Ring Flange O.D. D <sub>1</sub>	Flange Width C <sub>2</sub>	Shaft			Housing	G <sub>1</sub>	G <sub>2</sub>	C <sub>g</sub>	
					Max Shaft Fillet Radius R <sup>(5)</sup>	Backing Shoulder Dia.		Backing Shoulder Dia. D <sub>a</sub>				
mm in.	mm in.	mm in.	mm in.	mm in.	mm in.	mm in.	mm in.	mm in.				kg lbs.
21.692 0.8540	17.462 0.6875	-4.8 -0.19	89.659 3.5299	4.762 0.1875	3.5 0.14	50.0 1.97	56.0 2.20	82.0 3.23	30.0	12.2	0.0732	0.53 1.18
25.400 1.0000	19.050 0.7500	-6.4 -0.25	86.919 3.4220	3.970 0.1563	3.5 0.14	50.0 1.97	57.0 2.24	80.0 3.15	35.2	14.3	0.0801	0.58 1.27
17.462 0.6875	13.495 0.5313	-2.0 -0.08	84.038 3.3086	3.571 0.1406	2.8 0.11	49.5 1.95	54.0 2.13	77.0 3.03	23.9	18.7	0.0725	0.36 0.81
17.145 0.6750	11.908 0.4688	0.0 0.00	80.564 3.1718	3.571 0.1406	1.5 0.06	49.5 1.95	52.0 2.05	75.0 2.95	21.0	17.5	0.0766	0.32 0.71
18.258 0.7188	15.083 0.5938	-3.8 -0.15	76.200 3.0000	3.175 0.1250	1.5 0.06	49.0 1.93	51.0 2.01	71.0 2.80	30.6	25.9	0.0751	0.31 0.68
12.700 0.5000	9.525 0.3750	-1.3 -0.05	74.232 2.9225	2.794 0.1100	1.5 0.06	48.5 1.91	51.0 2.01	69.0 2.72	20.0	23.6	0.0637	0.19 0.41
30.302 1.1930	23.812 0.9375	-8.1 -0.32	97.937 3.8558	4.762 0.1875	3.5 0.14	53.0 2.09	59.0 2.32	89.9 3.54	49.9	14.5	0.0903	0.99 2.16
25.400 1.0000	19.050 0.7500	-6.4 -0.25	86.919 3.4220	3.970 0.1563	1.5 0.06	51.0 2.01	53.0 2.09	80.0 3.15	35.2	14.3	0.0801	0.58 1.27
25.000 0.9843	22.000 0.8661	-6.1 -0.24	106.000 4.1732	5.000 0.1969	2.0 0.08	56.0 2.20	59.0 2.32	95.0 3.74	41.9	18.4	0.0851	1.05 2.31
22.225 0.8750	15.875 0.6250	-4.3 -0.17	94.661 3.7268	4.762 0.1875	2.0 0.08	51.0 2.01	55.0 2.17	86.0 3.39	33.8	14.0	0.0773	0.62 1.37
21.692 0.8540	17.462 0.6875	-4.8 -0.19	89.659 3.5299	4.762 0.1875	1.5 0.06	50.0 1.97	53.0 2.09	82.0 3.23	30.0	12.2	0.0732	0.53 1.18
26.000 1.0236	20.500 0.8071	-6.6 -0.26	85.000 3.3465	4.500 0.1772	1.5 0.06	52.0 2.05	55.0 2.17	79.0 3.11	35.7	16.5	0.0843	0.56 1.22
20.000 0.7874	15.500 0.6102	-3.3 -0.13	79.000 3.1102	3.500 0.1378	1.0 0.04	51.0 2.01	53.0 2.09	74.0 2.91	28.7	16.2	0.0788	0.36 0.79
30.886 1.2160	23.812 0.9375	-10.2 -0.40	91.986 3.6215	4.750 0.1870	3.5 0.14	52.0 2.05	58.0 2.28	82.0 3.23	39.5	12.5	0.0808	0.79 1.72
25.400 1.0000	19.050 0.7500	-6.4 -0.25	86.919 3.4220	3.970 0.1563	3.5 0.14	51.0 2.01	58.0 2.28	80.0 3.15	35.2	14.3	0.0801	0.56 1.23
29.900 1.1772	22.225 0.8750	-9.1 -0.36	100.686 3.9640	5.558 0.2188	3.5 0.14	52.0 2.05	59.0 2.32	87.0 3.43	42.5	11.3	0.0805	0.95 2.09
29.900 1.1772	22.225 0.8750	-9.1 -0.36	97.536 3.8400	5.558 0.2188	3.5 0.14	52.0 2.05	59.0 2.32	87.0 3.43	42.5	11.3	0.0805	0.86 1.90

<sup>(4)</sup>Negative value indicates effective center inside cone (inner-ring) backface.

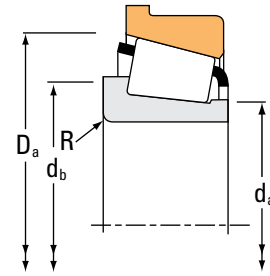
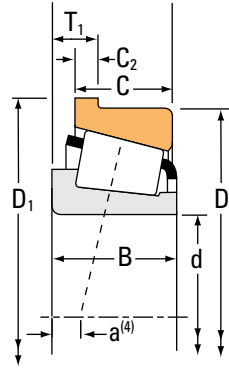
<sup>(5)</sup>These maximum fillet radii will be cleared by the bearing corners.

Continued on next page.

# TAPERED ROLLER BEARINGS

SINGLE-ROW • TYPE TSF

## TYPE TSF



Bearing Dimensions			Load Ratings							Part Number		
Bore d	O.D. D	Width T <sub>1</sub>	Dynamic <sup>(1)</sup>		Factors <sup>(2)</sup>		Dynamic <sup>(3)</sup>		Factors <sup>(2)</sup>	Static C <sub>0</sub>	Inner	Outer
			C <sub>1</sub>	e	Y	C <sub>90</sub>	C <sub>a90</sub>	K	C <sub>0</sub>			
mm in.	mm in.	mm in.	N lbf			N lbf	N lbf		N lbf			
46.037 1.8125	85.000 3.3465	9.525 0.3750	93300 21000	0.35	1.73	24200 5440	14300 3220	1.69	117000 26200		2984	2924-B
46.037 1.8125	79.375 3.1250	7.539 0.2968	52000 11700	0.37	1.60	13500 3030	8630 1940	1.56	61300 13800		18690	18620-B
47.625 1.8750	120.650 4.7500	16.574 0.6525	207000 46600	0.31	1.91	53800 12100	28900 6510	1.86	244000 54800		617	612-B
47.625 1.8750	108.966 4.2900	14.288 0.5625	202000 45500	0.40	1.49	52400 11800	36100 8110	1.45	202000 45400		59187	59429-B
47.625 1.8750	107.950 4.2500	11.112 0.4375	136000 30500	0.34	1.79	35200 7900	20200 4540	1.74	166000 37200		463	453-B
47.625 1.8750	107.950 4.2500	11.112 0.4375	161000 36100	0.34	1.79	41700 9370	23900 5380	1.74	166000 37200		467	453-B
47.625 1.8750	95.250 3.7500	11.140 0.4386	147000 33100	0.55	1.10	38200 8590	35700 8030	1.07	157000 35400	HM804846	HM804811-B	
47.625 1.8750	93.264 3.6718	11.112 0.4375	122000 27500	0.34	1.77	31700 7120	18300 4120	1.73	153000 34300		3779	3720-B
47.625 1.8750	93.264 3.6718	11.112 0.4375	122000 27500	0.34	1.77	31700 7120	18300 4120	1.73	153000 34300		3778	3720-B
47.625 1.8750	90.000 3.5433	8.887 0.3499	102000 22900	0.32	1.88	26400 5930	14400 3250	1.83	95800 21500		369A	362-B
47.625 1.8750	90.000 3.5433	8.887 0.3499	102000 22900	0.32	1.88	26400 5930	14400 3250	1.83	95800 21500		369-S	362-B
47.625 1.8750	88.900 3.5000	8.887 0.3499	102000 22900	0.32	1.88	26400 5930	14400 3250	1.83	95800 21500		369-S	362AB
49.212 1.9375	114.300 4.5000	16.670 0.6563	224000 50300	0.43	1.39	58000 13000	42700 9600	1.36	256000 57500		65390	65320-B
49.212 1.9375	111.125 4.3750	14.288 0.5625	172000 38700	0.30	2.02	44600 10000	22700 5090	1.97	206000 46200		545	532-B
49.212 1.9375	90.000 3.5433	8.887 0.3499	102000 22900	0.32	1.88	26400 5930	14400 3250	1.83	95800 21500		365-S	362-B
49.982 1.9678	111.125 4.3750	14.288 0.5625	172000 38700	0.30	2.02	44600 10000	22700 5090	1.97	206000 46200		546	532-B
49.987 1.9680	80.962 3.1875	7.145 0.2813	60800 13700	0.36	1.69	15800 3540	9590 2160	1.64	88800 20000		L305648	L305610-B

<sup>(1)</sup>Based on 1 x 10<sup>6</sup> revolutions L<sub>10</sub> life, for the ISO life-calculation method.

<sup>(2)</sup>Consult your Timken engineer for instructions on use or review the Timken Engineering Manual on timken.com/catalogs.

<sup>(3)</sup>Based on 90 x 10<sup>6</sup> revolutions L<sub>10</sub> life, for The Timken Company life-calculation method. C<sub>90</sub> and C<sub>a90</sub> are radial and thrust values.

Bearing Dimensions									Geometry Factors			Bearing Weight
Width B	Width C	Eff. Ctr. a <sup>(4)</sup>	Outer Ring Flange O.D. D <sub>1</sub>	Flange Width C <sub>2</sub>	Shaft			Housing	G <sub>1</sub>	G <sub>2</sub>	C <sub>g</sub>	
					Max Shaft Fillet Radius R <sup>(5)</sup>	Backing Shoulder Dia. d <sub>a</sub>	Backing Shoulder Dia. d <sub>b</sub>	Backing Shoulder Dia. D <sub>a</sub>				
mm in.	mm in.	mm in.	mm in.	mm in.	mm in.	mm in.	mm in.	mm in.				kg lbs.
25.608 1.0082	20.638 0.8125	-6.4 -0.25	89.764 3.5340	4.762 0.1875	3.5 0.14	52.0 2.05	58.0 2.28	82.0 3.23	38.2	15.7	0.0832	0.65 1.43
17.462 0.6875	13.495 0.5313	-2.0 -0.08	84.038 3.3086	3.571 0.1406	2.8 0.11	51.0 2.01	56.0 2.20	77.0 3.03	23.9	18.7	0.0725	0.34 0.77
41.275 1.6250	31.750 1.2500	-14.0 -0.55	127.691 5.0272	7.142 0.2812	3.5 0.14	58.0 2.28	65.0 2.56	110.0 4.33	75.9	16.2	0.0694	2.42 5.33
36.512 1.4375	26.988 1.0625	-9.7 -0.38	115.214 4.5360	6.350 0.2500	3.5 0.14	59.0 2.32	65.0 2.56	101.0 3.98	57.3	15.2	0.0999	1.65 3.64
29.317 1.1542	22.225 0.8750	-7.1 -0.28	113.386 4.4640	5.558 0.2188	4.8 0.19	56.0 2.20	65.0 2.56	100.0 3.94	58.6	17.1	0.0946	1.31 2.88
29.317 1.1542	22.225 0.8750	-7.1 -0.28	113.386 4.4640	5.558 0.2188	0.8 0.03	56.0 2.20	57.0 2.24	100.0 3.94	58.6	17.1	0.0946	1.32 2.91
29.370 1.1563	24.021 0.9457	-3.8 -0.15	100.686 3.9640	5.001 0.1969	3.5 0.14	57.0 2.26	66.0 2.60	93.0 3.66	44.8	13.8	0.1017	1.02 2.24
30.302 1.1930	23.812 0.9375	-8.1 -0.32	97.937 3.8558	4.762 0.1875	3.5 0.14	55.0 2.17	61.0 2.40	89.9 3.54	49.9	14.5	0.0903	0.94 2.06
30.302 1.1930	23.812 0.9375	-8.1 -0.32	97.937 3.8558	4.762 0.1875	6.4 0.25	55.0 2.17	67.0 2.64	89.9 3.54	49.9	14.5	0.0903	0.92 2.02
22.225 0.8750	15.875 0.6250	-4.3 -0.17	94.661 3.7268	4.762 0.1875	3.5 0.14	53.0 2.09	60.0 2.36	86.0 3.39	33.8	14.0	0.0773	0.59 1.29
22.225 0.8750	15.875 0.6250	-4.3 -0.17	94.661 3.7268	4.762 0.1875	2.3 0.09	53.0 2.09	57.0 2.24	86.0 3.39	33.8	14.0	0.0773	0.59 1.30
22.225 0.8750	16.513 0.6501	-4.3 -0.17	93.662 3.6875	4.762 0.1875	2.3 0.09	53.0 2.09	57.0 2.24	86.0 3.39	33.8	14.0	0.0773	0.58 1.28
44.450 1.7500	34.925 1.3750	-12.4 -0.49	121.341 4.7772	7.145 0.2813	3.5 0.14	60.0 2.36	70.0 2.76	107.0 4.21	63.1	13.0	0.1053	2.27 5.01
36.957 1.4550	30.162 1.1875	-12.2 -0.48	117.373 4.6210	6.350 0.2500	3.5 0.14	57.0 2.24	64.0 2.52	100.0 3.94	64.3	16.1	0.0938	1.78 3.94
22.225 0.8750	15.875 0.6250	-4.3 -0.17	94.661 3.7268	4.762 0.1875	0.8 0.03	54.0 2.13	55.0 2.17	86.0 3.39	33.8	14.0	0.0773	0.57 1.25
36.957 1.4550	30.162 1.1875	-12.2 -0.48	117.373 4.6210	6.350 0.2500	3.5 0.14	58.0 2.28	65.0 2.56	100.0 3.94	64.3	16.1	0.0938	1.77 3.90
18.258 0.7188	14.288 0.5625	-2.5 -0.10	84.036 3.3085	3.175 0.1250	1.5 0.06	55.0 2.17	57.0 2.24	78.0 3.07	38.8	29.8	0.0841	0.38 0.83

<sup>(4)</sup>Negative value indicates effective center inside cone (inner-ring) backface.

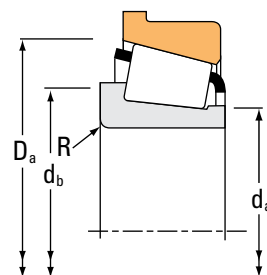
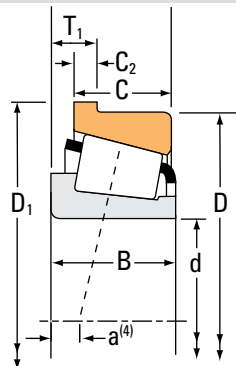
<sup>(5)</sup>These maximum fillet radii will be cleared by the bearing corners.

Continued on next page.

# TAPERED ROLLER BEARINGS

## SINGLE-ROW • TYPE TSF

### TYPE TSF



Bearing Dimensions			Load Ratings							Part Number	
Bore d	O.D. D	Width T <sub>1</sub>	Dynamic <sup>(1)</sup>			Dynamic <sup>(3)</sup>			Static C <sub>0</sub>	Inner	Outer
			C <sub>1</sub>	Factors <sup>(2)</sup> e Y		C <sub>90</sub>	Factors <sup>(2)</sup> K				
mm in.	mm in.	mm in.	N lbf			N lbf	N lbf		N lbf		
50.000 1.9685	110.000 4.3307	11.250 0.4429	149000 33400	0.35	1.74	38500 8660	22700 5110	1.69	160000 36000	X30310M	Y30310RM
50.000 1.9685	90.000 3.5433	8.887 0.3499	102000 22900	0.32	1.88	26400 5930	14400 3250	1.83	95800 21500	366	362-B
50.000 1.9685	90.000 3.5433	8.887 0.3499	102000 22900	0.32	1.88	26400 5930	14400 3250	1.83	95800 21500	365	362-B
50.800 2.0000	127.000 5.0000	16.670 0.6563	243000 54700	0.49	1.23	63100 14200	52700 11800	1.20	297000 66700	65200	65500-B
50.800 2.0000	120.650 4.7500	16.667 0.6562	207000 46600	0.31	1.91	53800 12100	28900 6510	1.86	244000 54800	619	612-B
50.800 2.0000	111.125 4.3750	15.083 0.5938	126000 28300	0.88	0.68	32700 7350	49500 11100	0.66	119000 26700	55200	55437-B
50.800 2.0000	107.950 4.2500	11.112 0.4375	161000 36100	0.34	1.79	41700 9370	23900 5380	1.74	166000 37200	455	453-B
50.800 2.0000	107.950 4.2500	11.115 0.4376	161000 36100	0.34	1.79	41700 9370	23900 5380	1.74	166000 37200	455-S	453-B
50.800 2.0000	104.775 4.1250	11.908 0.4688	153000 34500	0.33	1.80	39700 8930	22600 5090	1.76	189000 42600	45285	45220-B
50.800 2.0000	104.775 4.1250	11.908 0.4688	153000 34500	0.33	1.80	39700 8930	22600 5090	1.76	189000 42600	45285A	45220-B
50.800 2.0000	104.775 4.1250	11.908 0.4688	202000 45500	0.40	1.49	52400 11800	36100 8110	1.45	202000 45400	59201	59412-B
50.800 2.0000	104.775 4.1250	15.875 0.6250	203000 45700	0.49	1.23	52700 11900	44000 9890	1.20	223000 50200	HM807046	HM807010-B
50.800 2.0000	101.600 4.0000	11.908 0.4688	157000 35400	0.40	1.50	40800 9170	28000 6290	1.46	155000 35000	49585	49520-B
50.800 2.0000	93.264 3.6718	11.112 0.4375	122000 27500	0.34	1.77	31700 7120	18300 4120	1.73	153000 34300	3780	3720-B
50.800 2.0000	93.264 3.6718	11.112 0.4375	122000 27500	0.34	1.77	31700 7120	18300 4120	1.73	153000 34300	3775	3720-B
50.800 2.0000	92.075 3.6250	8.730 0.3437	98900 22200	0.38	1.59	25700 5770	16600 3720	1.55	130000 29200	28580	28521-B
50.800 2.0000	90.000 3.5433	8.888 0.3499	102000 22900	0.32	1.88	26400 5930	14400 3250	1.83	95800 21500	368	362-B

<sup>(1)</sup>Based on 1 x 10<sup>6</sup> revolutions L<sub>10</sub> life, for the ISO life-calculation method.

<sup>(2)</sup>Consult your Timken engineer for instructions on use or review the Timken Engineering Manual on timken.com/catalogs.

<sup>(3)</sup>Based on 90 x 10<sup>6</sup> revolutions L<sub>10</sub> life, for The Timken Company life-calculation method. C<sub>90</sub> and C<sub>a90</sub> are radial and thrust values.



Bearing Dimensions									Geometry Factors			Bearing Weight
Width B	Width C	Eff. Ctr. a <sup>(4)</sup>	Outer Ring Flange O.D. D <sub>1</sub>	Flange Width C <sub>2</sub>	Shaft			Housing	G <sub>1</sub>	G <sub>2</sub>	C <sub>g</sub>	
					Max Shaft Fillet Radius R <sup>(5)</sup>	Backing Shoulder Dia.		Backing Shoulder Dia. D <sub>a</sub>				
mm in.	mm in.	mm in.	mm in.	mm in.	mm in.	mm in.	mm in.	mm in.				kg lbs.
27.000 1.0630	23.000 0.9055	-6.1 -0.24	116.000 4.5669	5.000 0.1969	2.5 0.10	61.0 2.40	65.0 2.56	104.0 4.09	51.0	17.5	0.0907	1.30 2.87
22.225 0.8750	15.875 0.6250	-4.3 -0.17	94.661 3.7268	4.762 0.1875	2.3 0.09	55.0 2.17	59.0 2.32	86.0 3.39	33.8	14.0	0.0773	0.56 1.23
22.225 0.8750	15.875 0.6250	-4.3 -0.17	94.661 3.7268	4.762 0.1875	2.0 0.08	55.0 2.17	58.0 2.28	86.0 3.39	33.8	14.0	0.0773	0.56 1.23
44.450 1.7500	34.925 1.3750	-9.4 -0.37	134.041 5.2772	7.145 0.2813	3.5 0.14	69.0 2.72	75.0 2.95	120.0 4.72	83.2	17.2	0.0827	2.98 6.56
41.275 1.6250	31.750 1.2500	-14.0 -0.55	127.691 5.0272	7.142 0.2812	3.5 0.14	61.0 2.40	67.0 2.64	110.0 4.33	75.9	16.2	0.0694	2.34 5.16
26.909 1.0594	20.638 0.8125	7.1 0.28	116.683 4.5938	5.558 0.2188	3.5 0.14	63.9 2.51	71.0 2.80	107.0 4.21	36.8	13.2	0.1085	1.28 2.83
29.317 1.1542	22.225 0.8750	-7.1 -0.28	113.386 4.4640	5.558 0.2188	0.8 0.03	59.0 2.32	60.0 2.36	100.0 3.94	58.6	17.1	0.0946	1.27 2.78
29.317 1.1542	22.225 0.8750	-7.1 -0.28	113.386 4.4640	5.558 0.2188	3.5 0.14	59.0 2.32	65.0 2.56	100.0 3.94	58.6	17.1	0.0946	1.26 2.77
30.958 1.2188	23.812 0.9375	-8.1 -0.32	110.231 4.3398	5.558 0.2188	2.3 0.09	59.0 2.32	63.0 2.48	101.0 3.98	63.5	16.9	0.0971	1.26 2.77
30.958 1.2188	23.812 0.9375	-8.1 -0.32	110.231 4.3398	5.558 0.2188	0.8 0.03	59.0 2.32	60.0 2.36	101.0 3.98	63.5	16.9	0.0971	1.26 2.76
36.512 1.4375	28.575 1.1250	-9.7 -0.38	110.500 4.3504	3.970 0.1563	0.8 0.03	61.0 2.40	62.0 2.44	101.0 3.98	57.3	15.2	0.0999	1.45 3.19
36.512 1.4375	28.575 1.1250	-7.4 -0.29	114.300 4.5000	7.938 0.3125	3.5 0.14	63.1 2.48	70.0 2.76	103.0 4.06	63.9	17.1	0.0760	1.60 3.53
31.750 1.2500	25.400 1.0000	-7.1 -0.28	107.056 4.2148	5.558 0.2188	3.5 0.14	59.0 2.32	66.0 2.60	98.0 3.86	49.1	16.8	0.0946	1.18 2.61
30.302 1.1930	23.812 0.9375	-8.1 -0.32	97.937 3.8558	4.762 0.1875	3.5 0.14	58.0 2.28	64.0 2.52	89.9 3.54	49.9	14.5	0.0903	0.88 1.93
30.302 1.1930	23.812 0.9375	-8.1 -0.32	97.937 3.8558	4.762 0.1875	0.8 0.03	58.0 2.28	58.0 2.28	89.9 3.54	49.9	14.5	0.0903	0.89 1.95
25.400 1.0000	19.845 0.7813	-4.8 -0.19	95.941 3.7772	3.967 0.1562	3.5 0.14	57.0 2.24	63.0 2.48	89.0 3.50	46.4	18.9	0.0912	0.73 1.60
22.225 0.8750	15.875 0.6250	-4.3 -0.17	94.661 3.7268	4.762 0.1875	1.5 0.06	56.0 2.20	58.0 2.28	86.0 3.39	33.8	14.0	0.0773	0.54 1.20

<sup>(4)</sup>Negative value indicates effective center inside cone (inner-ring) backface.

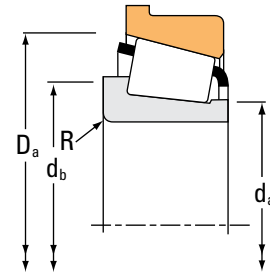
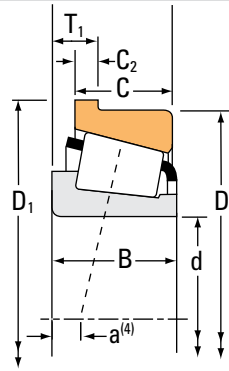
<sup>(5)</sup>These maximum fillet radii will be cleared by the bearing corners.

Continued on next page.

# TAPERED ROLLER BEARINGS

## SINGLE-ROW • TYPE TSF

### TYPE TSF



Bearing Dimensions			Load Ratings							Part Number		
Bore d	O.D. D	Width T <sub>1</sub>	Dynamic <sup>(1)</sup>		Factors <sup>(2)</sup>		Dynamic <sup>(3)</sup>		Factors <sup>(2)</sup>	Static	Inner	Outer
			C <sub>1</sub>	e	Y	C <sub>90</sub>	C <sub>a90</sub>	K	C <sub>0</sub>			
mm in.	mm in.	mm in.	N lbf			N lbf	N lbf		N lbf			
50.800 2.0000	90.000 3.5433	8.888 0.3499	102000 22900	0.32	1.88	26400 5930	14400 3250	1.83	95800 21500		368A	362-B
50.800 2.0000	88.900 3.5000	8.887 0.3499	102000 22900	0.32	1.88	26400 5930	14400 3250	1.83	95800 21500		368A	362AB
50.800 2.0000	88.900 3.5000	8.888 0.3499	102000 22900	0.32	1.88	26400 5930	14400 3250	1.83	95800 21500		368	362AB
50.800 2.0000	85.725 3.3750	9.906 0.3900	61100 13700	0.57	1.06	15800 3560	15400 3470	1.03	63900 14400		18200	18337-B
50.800 2.0000	85.000 3.3465	7.539 0.2968	54700 12300	0.41	1.48	14200 3190	9840 2210	1.44	67500 15200		18790	18720-B
50.800 2.0000	80.962 3.1875	7.145 0.2813	60800 13700	0.36	1.69	15800 3540	9590 2160	1.64	88800 20000		L305649	L305610-B
50.800 2.0000	77.788 3.0625	5.969 0.2350	37300 8390	0.34	1.78	9680 2180	5570 1250	1.74	47200 10600		LL205449	LL205410-B
52.000 2.0472	85.725 3.3750	9.906 0.3900	51600 11600	0.57	1.06	13400 3010	13000 2920	1.03	63900 14400		18204X	18337-B
52.387 2.0625	111.125 4.3750	15.083 0.5938	126000 28300	0.88	0.68	32700 7350	49500 11100	0.66	119000 26700		55206	55437-B
52.387 2.0625	93.264 3.6718	11.112 0.4375	122000 27500	0.34	1.77	31700 7120	18300 4120	1.73	153000 34300		3767	3720-B
52.387 2.0625	92.075 3.6250	8.730 0.3437	98900 22200	0.38	1.59	25700 5770	16600 3720	1.55	130000 29200		28584	28521-B
53.975 2.1250	136.525 5.3750	16.662 0.6560	276000 62100	0.36	1.66	71600 16100	44400 9980	1.61	298000 67000		636	632-B
53.975 2.1250	127.000 5.0000	7.137 0.2810	226000 50800	0.35	1.73	58600 13200	34700 7810	1.69	248000 55700		557-S	553-BA
53.975 2.1250	127.000 5.0000	17.462 0.6875	306000 68800	0.30	2.01	79300 17800	40500 9110	1.96	370000 83300		6280	6220-B
53.975 2.1250	123.825 4.8750	14.288 0.5625	226000 50800	0.35	1.73	58600 13200	34700 7810	1.69	248000 55700		557-S	552-B
53.975 2.1250	120.650 4.7500	16.667 0.6562	207000 46600	0.31	1.91	53800 12100	28900 6510	1.86	244000 54800		621	612-B
53.975 2.1250	107.950 4.2500	11.115 0.4376	161000 36100	0.34	1.79	41700 9370	23900 5380	1.74	166000 37200		456	453-B

<sup>(1)</sup>Based on  $1 \times 10^6$  revolutions  $L_{10}$  life, for the ISO life-calculation method.

<sup>(2)</sup>Consult your Timken engineer for instructions on use or review the Timken Engineering Manual on [timken.com/catalogs](http://timken.com/catalogs).

<sup>(3)</sup>Based on  $90 \times 10^6$  revolutions  $L_{10}$  life, for The Timken Company life-calculation method.  $C_{90}$  and  $C_{a90}$  are radial and thrust values.

Bearing Dimensions									Geometry Factors			Bearing Weight
Width B	Width C	Eff. Ctr. a <sup>(4)</sup>	Outer Ring Flange O.D. D <sub>1</sub>	Flange Width C <sub>2</sub>	Shaft			Housing	G <sub>1</sub>	G <sub>2</sub>	C <sub>g</sub>	
					Max Shaft Fillet Radius R <sup>(5)</sup>	Backing Shoulder Dia. d <sub>a</sub>	Backing Shoulder Dia. d <sub>b</sub>	Backing Shoulder Dia. D <sub>a</sub>				
mm in.	mm in.	mm in.	mm in.	mm in.	mm in.	mm in.	mm in.	mm in.				kg lbs.
22.225 0.8750	15.875 0.6250	-4.3 -0.17	94.661 3.7268	4.762 0.1875	3.5 0.14	56.0 2.20	62.0 2.44	86.0 3.39	33.8	14.0	0.0773	0.54 1.19
22.225 0.8750	16.513 0.6501	-4.3 -0.17	93.662 3.6875	4.762 0.1875	3.5 0.14	56.0 2.20	62.0 2.44	86.0 3.39	33.8	14.0	0.0773	0.53 1.16
22.225 0.8750	16.513 0.6501	-4.3 -0.17	93.662 3.6875	4.762 0.1875	1.5 0.06	56.0 2.20	58.0 2.28	86.0 3.39	33.8	14.0	0.0773	0.53 1.18
18.263 0.7190	12.700 0.5000	2.0 0.08	89.586 3.5270	3.556 0.1400	1.5 0.06	56.0 2.20	59.0 2.32	83.0 3.27	26.1	22.1	0.0852	0.41 0.91
17.462 0.6875	13.495 0.5313	-0.8 -0.03	88.570 3.4870	3.571 0.1406	3.5 0.14	56.0 2.20	62.0 2.44	82.0 3.23	28.6	23.4	0.0789	0.40 0.89
18.258 0.7188	14.288 0.5625	-2.5 -0.10	84.036 3.3085	3.175 0.1250	1.5 0.06	56.0 2.20	58.0 2.28	78.0 3.07	38.8	29.8	0.0841	0.37 0.81
12.700 0.5000	9.525 0.3750	0.0 0.00	80.582 3.1725	2.794 0.1100	1.5 0.06	55.0 2.17	57.0 2.24	75.0 2.95	24.2	29.1	0.0699	0.21 0.46
18.263 0.7190	12.700 0.5000	2.0 0.08	89.586 3.5270	3.556 0.1400	2.0 0.08	57.0 2.24	60.0 2.36	83.0 3.27	26.1	22.1	0.0852	0.39 0.88
26.909 1.0594	20.638 0.8125	7.1 0.28	116.683 4.5938	5.558 0.2188	3.5 0.14	63.9 2.51	72.0 2.83	107.0 4.21	36.8	13.2	0.1085	1.26 2.77
30.302 1.1930	23.812 0.9375	-8.1 -0.32	97.937 3.8558	4.762 0.1875	2.3 0.09	59.0 2.32	63.0 2.48	89.9 3.54	49.9	14.5	0.0903	0.86 1.87
25.400 1.0000	19.845 0.7813	-4.8 -0.19	95.941 3.7772	3.967 0.1562	3.5 0.14	58.0 2.28	65.0 2.56	89.0 3.50	46.4	18.9	0.0912	0.69 1.52
41.275 1.6250	31.750 1.2500	-11.2 -0.44	143.561 5.6520	7.137 0.2810	3.5 0.14	67.0 2.64	73.0 2.87	125.0 4.92	106.4	21.0	0.0814	3.19 7.04
36.678 1.4440	34.925 1.3750	-9.4 -0.37	133.248 5.2460	6.350 0.2500	3.5 0.14	67.0 2.64	73.0 2.87	116.0 4.57	91.0	21.1	0.1108	2.46 5.40
52.388 2.0625	41.275 1.6250	-19.6 -0.77	134.925 5.3120	7.938 0.3125	3.5 0.14	67.0 2.64	74.0 2.91	117.0 4.61	103.1	18.7	0.0757	3.37 7.43
36.678 1.4440	30.162 1.1875	-9.4 -0.37	130.073 5.1210	6.350 0.2500	3.5 0.14	67.0 2.64	73.0 2.87	116.0 4.57	91.0	21.1	0.1108	2.31 5.08
41.275 1.6250	31.750 1.2500	-14.0 -0.55	127.691 5.0272	7.142 0.2812	3.5 0.14	63.0 2.48	70.0 2.76	110.0 4.33	75.9	16.2	0.0694	2.25 4.97
29.317 1.1542	22.225 0.8750	-7.1 -0.28	113.386 4.4640	5.558 0.2188	3.5 0.14	61.0 2.40	68.0 2.68	100.0 3.94	58.6	17.1	0.0946	1.20 2.63

<sup>(4)</sup>Negative value indicates effective center inside cone (inner-ring) backface.

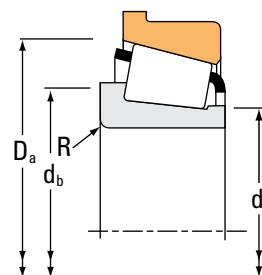
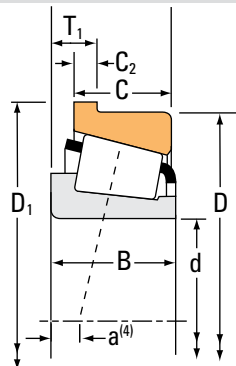
<sup>(5)</sup>These maximum fillet radii will be cleared by the bearing corners.

Continued on next page.

# TAPERED ROLLER BEARINGS

SINGLE-ROW • TYPE TSF

## TYPE TSF



Bearing Dimensions			Load Ratings							Part Number		
Bore d	O.D. D	Width T <sub>1</sub>	Dynamic <sup>(1)</sup>		Factors <sup>(2)</sup>		Dynamic <sup>(3)</sup>		Factors <sup>(2)</sup>	Static	Inner	Outer
			C <sub>1</sub>	e	Y	C <sub>90</sub>	C <sub>a90</sub>	K	C <sub>0</sub>			
mm in.	mm in.	mm in.	N lbf			N lbf	N lbf			N lbf		
53.975 2.1250	93.264 3.6718	10.320 0.4063	130000 29200	0.33	1.82	33600 7560	19000 4270	1.77		161000 36200	33895	33820-B
54.813 2.1580	135.755 5.3447	17.462 0.6875	321000 72300	0.32	1.85	83300 18700	46300 10400	1.80		404000 90900	6380	6320-B
54.987 2.1649	135.755 5.3447	17.462 0.6875	321000 72300	0.32	1.85	83300 18700	46300 10400	1.80		404000 90900	6381	6320-B
55.000 2.1654	120.000 4.7244	11.095 0.4368	143000 32200	0.38	1.56	37200 8360	24500 5500	1.52		186000 41900	475	472-B
55.000 2.1654	120.000 4.7244	12.000 0.4724	174000 39100	0.35	1.74	45100 10100	26600 5990	1.69		190000 42700	X30311M	Y30311RM
55.000 2.1654	110.000 4.3307	16.000 0.6299	234000 52700	0.40	1.48	60700 13700	42000 9450	1.44		253000 56800	XGB-33212	Y33212R
55.000 2.1654	96.838 3.8125	7.938 0.3125	108000 24200	0.35	1.69	28000 6280	16900 3810	1.65		107000 24100	385	382-B
55.562 2.1875	107.950 4.2500	11.112 0.4375	161000 36100	0.34	1.79	41700 9370	23900 5380	1.74		166000 37200	466-S	453-B
55.575 2.1880	96.838 3.8125	7.938 0.3125	108000 24200	0.35	1.69	28000 6280	16900 3810	1.65		107000 24100	389	382-B
57.150 2.2500	149.225 5.8750	17.462 0.6875	411000 92400	0.36	1.66	107000 24000	66000 14800	1.61		463000 104000	6455	6420-B
57.150 2.2500	139.700 5.5000	17.462 0.6875	243000 54700	0.49	1.23	63100 14200	52700 11800	1.20		297000 66700	65225	65550-B
57.150 2.2500	136.525 5.3750	16.662 0.6560	233000 52400	0.36	1.66	60400 13600	37400 8420	1.61		298000 67000	635	632-B
57.150 2.2500	135.755 5.3447	17.462 0.6875	321000 72300	0.32	1.85	83300 18700	46300 10400	1.80		404000 90900	6375	6320-B
57.150 2.2500	123.825 4.8750	14.288 0.5625	226000 50800	0.35	1.73	58600 13200	34700 7810	1.69		248000 55700	555-S	552-B
57.150 2.2500	120.650 4.7500	16.667 0.6562	207000 46600	0.31	1.91	53800 12100	28900 6510	1.86		244000 54800	623	612-B
57.150 2.2500	112.712 4.4375	11.112 0.4375	139000 31200	0.40	1.49	36000 8090	24800 5570	1.45		191000 43000	3979	3920-B
57.150 2.2500	107.950 4.2500	11.115 0.4376	161000 36100	0.34	1.79	41700 9370	23900 5380	1.74		166000 37200	469	453-B

<sup>(1)</sup>Based on  $1 \times 10^6$  revolutions  $L_{10}$  life, for the ISO life-calculation method.

<sup>(2)</sup>Consult your Timken engineer for instructions on use or review the Timken Engineering Manual on [timken.com/catalogs](http://timken.com/catalogs).

<sup>(3)</sup>Based on  $90 \times 10^6$  revolutions  $L_{10}$  life, for The Timken Company life-calculation method.  $C_{90}$  and  $C_{a90}$  are radial and thrust values.

Bearing Dimensions									Geometry Factors			Bearing Weight
Width B	Width C	Eff. Ctr. a <sup>(4)</sup>	Outer Ring Flange O.D. D <sub>1</sub>	Flange Width C <sub>2</sub>	Shaft			Housing	G <sub>1</sub>	G <sub>2</sub>	C <sub>g</sub>	
					Max Shaft Fillet Radius R <sup>(5)</sup>	Backing Shoulder Dia. d <sub>a</sub>	Backing Shoulder Dia. d <sub>b</sub>	Backing Shoulder Dia. D <sub>a</sub>				
mm in.	mm in.	mm in.	mm in.	mm in.	mm in.	mm in.	mm in.	mm in.				kg lbs.
28.575 1.1250	22.225 0.8750	-7.6 -0.30	97.937 3.8558	4.762 0.1875	1.5 0.06	60.0 2.36	63.0 2.48	91.0 3.58	52.5	18.5	0.0910	0.79 1.72
56.007 2.2050	44.450 1.7500	-19.3 -0.76	143.579 5.6527	7.938 0.3125	0.8 0.03	70.0 2.76	71.0 2.80	126.0 4.96	123.5	22.4	0.0827	4.18 9.23
56.007 2.2050	44.450 1.7500	-19.3 -0.76	143.579 5.6527	7.938 0.3125	3.5 0.14	70.0 2.76	76.0 2.99	126.0 4.96	123.5	22.4	0.0827	4.17 9.20
29.007 1.1420	24.237 0.9542	-4.1 -0.16	125.435 4.9384	5.537 0.2180	0.8 0.03	66.0 2.60	67.0 2.64	115.0 4.53	77.2	23.0	0.1083	1.70 3.74
29.000 1.1417	25.000 0.9843	-6.6 -0.26	127.000 5.0000	5.500 0.2165	2.5 0.10	70.0 2.76	71.0 2.80	113.0 4.45	62.8	24.0	0.0668	1.68 3.69
38.000 1.4961	29.000 1.1417	-9.9 -0.39	116.000 4.5669	7.000 0.2756	0.8 0.03	68.0 2.68	71.0 2.80	107.0 4.21	76.2	20.0	0.0758	1.72 3.80
21.946 0.8640	17.826 0.7018	-3.0 -0.12	101.498 3.9960	4.762 0.1875	2.3 0.09	61.0 2.40	65.0 2.56	94.0 3.70	42.0	15.7	0.0859	0.66 1.46
29.317 1.1542	22.225 0.8750	-7.1 -0.28	113.386 4.4640	5.558 0.2188	2.3 0.09	62.0 2.44	66.0 2.60	100.0 3.94	58.6	17.1	0.0946	1.17 2.58
21.946 0.8640	17.826 0.7018	-3.0 -0.12	101.498 3.9960	4.762 0.1875	2.3 0.09	61.0 2.40	65.0 2.56	94.0 3.70	42.0	15.7	0.0859	0.65 1.44
54.229 2.1350	44.450 1.7500	-15.0 -0.59	157.061 6.1835	7.938 0.3125	3.5 0.14	75.0 2.95	81.0 3.19	140.0 5.51	158.3	29.1	0.0931	5.21 11.50
44.450 1.7500	34.925 1.3750	-9.4 -0.37	152.400 6.0000	7.938 0.3125	3.5 0.14	71.0 2.79	80.0 3.15	120.0 4.72	83.2	17.2	0.0827	3.61 7.96
41.275 1.6250	31.750 1.2500	-11.2 -0.44	143.561 5.6520	7.137 0.2810	3.5 0.14	69.0 2.72	75.0 2.95	125.0 4.92	106.4	21.0	0.0814	3.10 6.84
56.007 2.2050	44.450 1.7500	-19.3 -0.76	143.579 5.6527	7.938 0.3125	4.3 0.17	72.0 2.83	80.0 3.15	126.0 4.96	123.5	22.4	0.0827	4.08 9.00
36.678 1.4440	30.162 1.1875	-9.4 -0.37	130.073 5.1210	6.350 0.2500	3.5 0.14	70.0 2.76	76.0 2.99	116.0 4.57	91.0	21.1	0.1108	2.23 4.90
41.275 1.6250	31.750 1.2500	-14.0 -0.55	127.691 5.0272	7.142 0.2812	3.5 0.14	66.0 2.60	72.0 2.83	110.0 4.33	75.9	16.2	0.0694	2.16 4.77
30.048 1.1830	23.812 0.9375	-4.6 -0.18	117.373 4.6210	4.762 0.1875	3.5 0.14	66.0 2.60	72.0 2.83	108.0 4.25	75.2	21.3	0.1092	1.40 3.10
29.317 1.1542	22.225 0.8750	-7.1 -0.28	113.386 4.4640	5.558 0.2188	3.5 0.14	68.0 2.68	72.0 2.83	100.0 3.94	58.6	17.1	0.0946	1.14 2.50

<sup>(4)</sup>Negative value indicates effective center inside cone (inner-ring) backface.

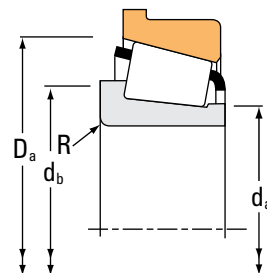
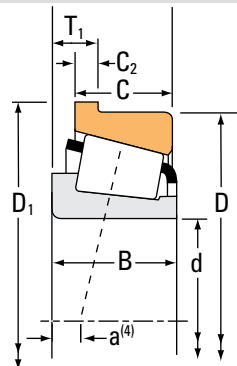
<sup>(5)</sup>These maximum fillet radii will be cleared by the bearing corners.

Continued on next page.

# TAPERED ROLLER BEARINGS

## SINGLE-ROW • TYPE TSF

### TYPE TSF



Bearing Dimensions			Load Ratings							Part Number		
Bore d	O.D. D	Width T <sub>1</sub>	Dynamic <sup>(1)</sup>		Factors <sup>(2)</sup>		Dynamic <sup>(3)</sup>		Factors <sup>(2)</sup>	Static	Inner	Outer
			C <sub>1</sub>	e	Y	C <sub>90</sub>	C <sub>a90</sub>	K	C <sub>0</sub>			
mm in.	mm in.	mm in.	N lbf			N lbf	N lbf			N lbf		
57.150 2.2500	107.950 4.2500	11.115 0.4376	161000 36100	0.34	1.79	41700 9370	23900 5380	1.74		166000 37200	462	453-B
57.150 2.2500	104.775 4.1250	11.908 0.4688	153000 34500	0.33	1.80	39700 8930	22600 5090	1.76		189000 42600	45290	45220-B
57.150 2.2500	104.775 4.1250	11.908 0.4688	153000 34500	0.33	1.80	39700 8930	22600 5090	1.76		189000 42600	45291	45220-B
57.150 2.2500	97.630 3.8437	9.124 0.3592	123000 27700	0.40	1.49	32000 7180	22000 4950	1.45		142000 32000	28682	28622-B
57.150 2.2500	96.838 3.8125	7.938 0.3125	108000 24200	0.35	1.69	28000 6280	16900 3810	1.65		107000 24100	387	382-B
57.150 2.2500	96.838 3.8125	7.938 0.3125	108000 24200	0.35	1.69	28000 6280	16900 3810	1.65		107000 24100	387A	382-B
57.150 2.2500	87.312 3.4375	7.145 0.2813	62700 14100	0.39	1.54	16300 3650	10800 2430	1.50		95600 21500	L507949	L507910-B
57.150 2.2500	84.933 3.3438	5.969 0.2350	36100 8120	0.37	1.62	9370 2110	5940 1340	1.58		46800 10500	LL408049	LL408010-B
58.737 2.3125	112.712 4.4375	11.112 0.4375	139000 31200	0.40	1.49	36000 8090	24800 5570	1.45		191000 43000	3981	3920-B
59.931 2.3595	150.089 5.9090	15.875 0.6250	318000 71400	0.33	1.84	82400 18500	45900 10300	1.80		417000 93800	745	742-B
59.977 2.3613	100.000 3.9370	9.525 0.3750	106000 23800	0.43	1.41	27500 6180	20000 4500	1.37		149000 33500	28980	28921-B
59.987 2.3617	130.175 5.1250	16.637 0.6550	198000 44400	0.82	0.73	51200 11500	71900 16200	0.71		183000 41100	HM911244	HM911210-B
59.987 2.3617	129.944 5.1159	14.288 0.5625	191000 42900	0.35	1.73	49400 11100	29300 6590	1.69		248000 55700	558-S	553-SB
59.987 2.3617	104.775 4.1250	10.320 0.4063	115000 25800	0.39	1.55	29700 6680	19700 4440	1.51		120000 27000	39236	39412-B
60.000 2.3622	120.000 4.7244	11.095 0.4368	143000 32200	0.38	1.56	37200 8360	24500 5500	1.52		186000 41900	476	472-B
60.000 2.3622	112.712 4.4375	11.112 0.4375	139000 31200	0.40	1.49	36000 8090	24800 5570	1.45		191000 43000	3977	3920-B
60.000 2.3622	110.000 4.3307	10.320 0.4063	131000 29400	0.46	1.31	33800 7610	26600 5970	1.27		161000 36300	29580	29521-B

<sup>(1)</sup>Based on  $1 \times 10^6$  revolutions  $L_{10}$  life, for the ISO life-calculation method.

<sup>(2)</sup>Consult your Timken engineer for instructions on use or review the Timken Engineering Manual on [timken.com/catalogs](http://timken.com/catalogs).

<sup>(3)</sup>Based on  $90 \times 10^6$  revolutions  $L_{10}$  life, for The Timken Company life-calculation method.  $C_{90}$  and  $C_{a90}$  are radial and thrust values.

Bearing Dimensions									Geometry Factors			Bearing Weight
Width B	Width C	Eff. Ctr. a <sup>(4)</sup>	Outer Ring Flange O.D. D <sub>1</sub>	Flange Width C <sub>2</sub>	Shaft			Housing	G <sub>1</sub>	G <sub>2</sub>	C <sub>g</sub>	
					Max Shaft Fillet Radius R <sup>(5)</sup>	Backing Shoulder Dia.		Backing Shoulder Dia. D <sub>a</sub>				
mm in.	mm in.	mm in.	mm in.	mm in.	mm in.	mm in.	mm in.	mm in.				kg lbs.
29.317 1.1542	22.225 0.8750	-7.1 -0.28	113.386 4.4640	5.558 0.2188	2.3 0.09	63.0 2.48	67.0 2.64	100.0 3.94	58.6	17.1	0.0946	1.14 2.50
30.958 1.2188	23.812 0.9375	-8.1 -0.32	110.231 4.3398	5.558 0.2188	2.3 0.09	65.0 2.56	68.0 2.68	101.0 3.98	63.5	16.9	0.0971	1.13 2.48
30.958 1.2188	23.812 0.9375	-8.1 -0.32	110.231 4.3398	5.558 0.2188	6.4 0.25	65.0 2.56	76.0 2.99	101.0 3.98	63.5	16.9	0.0971	1.10 2.41
24.608 0.9688	19.446 0.7656	-3.3 -0.13	101.498 3.9960	3.962 0.1560	3.5 0.14	63.0 2.48	70.0 2.76	94.0 3.70	54.0	22.6	0.0979	0.75 1.66
21.946 0.8640	17.826 0.7018	-3.0 -0.12	101.498 3.9960	4.762 0.1875	2.3 0.09	63.0 2.48	67.0 2.64	94.0 3.70	42.0	15.7	0.0859	0.63 1.39
21.946 0.8640	17.826 0.7018	-3.0 -0.12	101.498 3.9960	4.762 0.1875	3.5 0.14	63.0 2.48	70.0 2.76	94.0 3.70	42.0	15.7	0.0859	0.63 1.38
18.258 0.7188	14.288 0.5625	-0.8 -0.03	90.488 3.5625	3.175 0.1250	1.5 0.06	62.0 2.44	65.0 2.56	85.0 3.35	46.1	38.5	0.0914	0.40 0.88
12.700 0.5000	9.525 0.3750	1.5 0.06	87.727 3.4538	2.794 0.1100	1.5 0.06	61.0 2.40	64.0 2.52	82.0 3.23	27.4	36.3	0.0749	0.24 0.52
30.048 1.1830	23.812 0.9375	-4.6 -0.18	117.373 4.6210	4.762 0.1875	3.5 0.14	67.0 2.64	73.0 2.87	108.0 4.25	75.2	21.3	0.1092	1.37 3.03
46.672 1.8375	36.512 1.4375	-11.9 -0.47	157.912 6.2170	7.938 0.3125	3.5 0.14	75.0 2.95	81.0 3.19	143.0 5.63	159.6	26.3	0.0898	4.40 9.69
25.400 1.0000	19.845 0.7813	-2.5 -0.10	103.962 4.0930	3.970 0.1563	3.5 0.14	67.0 2.64	73.0 2.87	98.0 3.86	60.1	24.5	0.1032	0.79 1.75
30.924 1.2175	23.812 0.9375	7.9 0.31	136.525 5.3750	6.350 0.2500	3.5 0.14	74.4 2.93	84.0 3.31	123.6 4.87	56.4	16.5	0.0842	2.09 4.60
36.678 1.4440	30.162 1.1875	-9.4 -0.37	136.025 5.3553	6.350 0.2500	3.5 0.14	69.0 2.72	75.0 2.95	116.0 4.57	91.0	21.1	0.1108	2.46 5.41
22.000 0.8661	15.875 0.6250	-1.5 -0.06	109.433 4.3084	4.762 0.1875	2.3 0.09	67.0 2.64	71.0 2.80	102.0 4.02	51.7	19.5	0.0947	0.77 1.70
29.007 1.1420	24.237 0.9542	-4.1 -0.16	125.435 4.9384	5.537 0.2180	2.0 0.08	69.0 2.72	73.0 2.87	115.0 4.53	77.2	23.0	0.1083	1.60 3.51
30.048 1.1830	23.812 0.9375	-4.6 -0.18	117.373 4.6210	4.762 0.1875	3.5 0.14	68.0 2.68	74.0 2.91	108.0 4.25	75.2	21.3	0.1092	1.34 2.97
25.400 1.0000	19.050 0.7500	-0.8 -0.03	113.800 4.4803	3.970 0.1563	3.5 0.14	68.0 2.68	75.0 2.95	105.0 4.13	70.3	25.9	0.1112	1.08 2.36

<sup>(4)</sup>Negative value indicates effective center inside cone (inner-ring) backface.

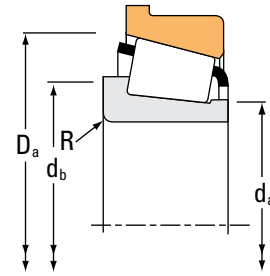
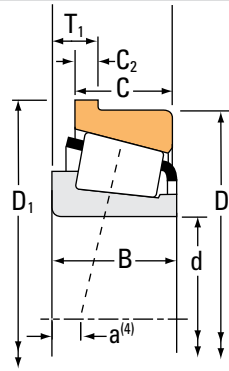
<sup>(5)</sup>These maximum fillet radii will be cleared by the bearing corners.

Continued on next page.

# TAPERED ROLLER BEARINGS

## SINGLE-ROW • TYPE TSF

### TYPE TSF



Bearing Dimensions			Load Ratings							Part Number		
Bore d	O.D. D	Width T <sub>1</sub>	Dynamic <sup>(1)</sup>		Factors <sup>(2)</sup>		Dynamic <sup>(3)</sup>		Factors <sup>(2)</sup>	Static	Inner	Outer
			C <sub>1</sub>	e	Y	C <sub>90</sub>	C <sub>a90</sub>	K	C <sub>0</sub>			
mm in.	mm in.	mm in.	N lbf			N lbf	N lbf		N lbf			
60.000 2.3622	107.950 4.2500	10.320 0.4063	131000 29400	0.46	1.31	33800 7610	26600 5970	1.27	161000 36300		29580	29520-B
60.000 2.3622	100.000 3.9370	8.500 0.3346	82500 18500	0.47	1.27	21400 4810	17300 3890	1.24	101000 22800		JP6049	JP6010-B
60.325 2.3750	161.925 6.3750	23.012 0.9060	298000 66900	0.71	0.85	77100 17300	93600 21000	0.82	330000 74200		9275	9221-B
60.325 2.3750	136.525 5.3750	16.662 0.6560	233000 52400	0.36	1.66	60400 13600	37400 8420	1.61	298000 67000		637	632-B
60.325 2.3750	135.755 5.3447	17.462 0.6875	321000 72300	0.32	1.85	83300 18700	46300 10400	1.80	404000 90900		6376	6320-B
60.325 2.3750	130.175 5.1250	19.050 0.7500	198000 44400	0.82	0.73	51200 11500	71900 16200	0.71	183000 41100		HM911245	HM911210-B
60.325 2.3750	123.825 4.8750	14.288 0.5625	226000 50800	0.35	1.73	58600 13200	34700 7810	1.69	248000 55700		558	552-B
60.325 2.3750	112.712 4.4375	11.112 0.4375	139000 31200	0.40	1.49	36000 8090	24800 5570	1.45	191000 43000		3980	3920-B
60.325 2.3750	100.000 3.9370	9.525 0.3750	106000 23800	0.43	1.41	27500 6180	20000 4500	1.37	149000 33500		28985	28921-B
61.912 2.4375	130.175 5.1250	19.050 0.7500	198000 44400	0.82	0.73	51200 11500	71900 16200	0.71	183000 41100		HM911249	HM911210-B
61.912 2.4375	123.825 4.8750	14.288 0.5625	191000 42900	0.35	1.73	49400 11100	29300 6590	1.69	248000 55700		554	552-B
63.500 2.5000	149.225 5.8750	17.462 0.6875	411000 92400	0.36	1.66	107000 24000	66000 14800	1.61	463000 104000		6475	6420-B
63.500 2.5000	136.525 5.3750	16.637 0.6550	323000 72600	0.36	1.67	83700 18800	51600 11600	1.62	335000 75400		H414235	H414210-B
63.500 2.5000	136.525 5.3750	16.662 0.6560	276000 62100	0.36	1.66	71600 16100	44400 9980	1.61	298000 67000		639	632-B
63.500 2.5000	127.000 5.0000	14.288 0.5625	196000 44100	0.36	1.65	50900 11400	31700 7130	1.61	262000 58900		565	563-B
63.500 2.5000	123.825 4.8750	14.288 0.5625	226000 50800	0.35	1.73	58600 13200	34700 7810	1.69	248000 55700		559	552-B
63.500 2.5000	120.000 4.7244	11.095 0.4368	143000 32200	0.38	1.56	37200 8360	24500 5500	1.52	186000 41900		477	472-B

<sup>(1)</sup>Based on  $1 \times 10^6$  revolutions  $L_{10}$  life, for the ISO life-calculation method.

<sup>(2)</sup>Consult your Timken engineer for instructions on use or review the Timken Engineering Manual on [timken.com/catalogs](http://timken.com/catalogs).

<sup>(3)</sup>Based on  $90 \times 10^6$  revolutions  $L_{10}$  life, for The Timken Company life-calculation method.  $C_{90}$  and  $C_{a90}$  are radial and thrust values.



Bearing Dimensions									Geometry Factors			Bearing Weight
Width B	Width C	Eff. Ctr. a <sup>(4)</sup>	Outer Ring Flange O.D. D <sub>1</sub>	Flange Width C <sub>2</sub>	Shaft			Housing	G <sub>1</sub>	G <sub>2</sub>	C <sub>g</sub>	
					Max Shaft Fillet Radius R <sup>(5)</sup>	Backing Shoulder Dia.		Backing Shoulder Dia. D <sub>a</sub>				
mm in.	mm in.	mm in.	mm in.	mm in.	mm in.	mm in.	mm in.	mm in.				kg lbs.
25.400 1.0000	19.050 0.7500	-0.8 -0.03	111.816 4.4022	3.970 0.1563	3.5 0.14	68.0 2.68	75.0 2.95	105.0 4.13	70.3	25.9	0.1112	1.02 2.25
20.000 0.7874	15.500 0.6102	1.3 0.05	105.000 4.1339	3.000 0.1181	2.0 0.08	66.0 2.60	69.0 2.72	98.0 3.86	39.5	22.5	0.0922	0.62 1.37
46.038 1.8125	30.162 1.1875	1.8 0.07	171.450 6.7500	7.137 0.2810	3.5 0.14	89.0 3.50	102.0 4.02	153.0 6.03	102.5	16.1	0.0984	4.83 10.65
41.275 1.6250	31.750 1.2500	-11.2 -0.44	143.561 5.6520	7.137 0.2810	3.5 0.14	72.0 2.83	78.0 3.07	125.0 4.92	106.4	21.0	0.0814	3.01 6.63
56.007 2.2050	44.450 1.7500	-19.3 -0.76	143.579 5.6527	7.938 0.3125	3.5 0.14	74.0 2.91	81.0 3.19	126.0 4.96	123.5	22.4	0.0827	3.95 8.73
33.338 1.3125	23.812 0.9375	5.3 0.21	136.525 5.3750	6.350 0.2500	5.0 0.20	74.0 2.91	93.0 3.66	123.6 4.87	56.4	16.5	0.0842	2.16 4.75
36.678 1.4440	30.162 1.1875	-9.4 -0.37	130.073 5.1210	6.350 0.2500	2.3 0.09	72.0 2.83	76.0 2.99	116.0 4.57	91.0	21.1	0.1108	2.15 4.72
30.048 1.1830	23.812 0.9375	-4.6 -0.18	117.373 4.6210	4.762 0.1875	3.5 0.14	68.0 2.68	75.0 2.95	108.0 4.25	75.2	21.3	0.1092	1.33 2.95
25.400 1.0000	19.845 0.7813	-2.5 -0.10	103.962 4.0930	3.970 0.1563	3.5 0.14	67.0 2.64	73.0 2.87	98.0 3.86	60.1	24.5	0.1032	0.78 1.73
33.338 1.3125	23.812 0.9375	5.3 0.21	136.525 5.3750	6.350 0.2500	3.5 0.14	74.0 2.91	91.0 3.58	123.6 4.87	56.4	16.5	0.0842	2.13 4.69
36.678 1.4440	30.162 1.1875	-9.4 -0.37	130.073 5.1210	6.350 0.2500	3.5 0.14	71.0 2.80	77.0 3.03	116.0 4.57	91.0	21.1	0.1108	2.09 4.61
54.229 2.1350	44.450 1.7500	-15.0 -0.59	157.061 6.1835	7.938 0.3125	3.5 0.14	80.0 3.15	86.0 3.39	140.0 5.51	158.3	29.1	0.0931	4.96 10.93
41.275 1.6250	31.750 1.2500	-10.9 -0.43	143.637 5.6550	7.112 0.2800	3.5 0.14	78.0 3.07	82.0 3.23	130.0 5.12	112.8	22.9	0.0827	2.94 6.47
41.275 1.6250	31.750 1.2500	-11.2 -0.44	143.561 5.6520	7.137 0.2810	3.5 0.14	74.0 2.91	81.0 3.19	125.0 4.92	106.4	21.0	0.0814	2.91 6.41
36.170 1.4240	28.575 1.1250	-8.1 -0.32	133.248 5.2460	6.350 0.2500	3.5 0.14	73.0 2.87	80.0 3.15	121.0 4.76	101.3	24.0	0.1167	2.16 4.76
36.678 1.4440	30.162 1.1875	-9.4 -0.37	130.073 5.1210	6.350 0.2500	3.5 0.14	75.0 2.95	81.0 3.19	116.0 4.57	91.0	21.1	0.1108	2.05 4.52
29.007 1.1420	24.237 0.9542	-4.1 -0.16	125.435 4.9384	5.537 0.2180	0.8 0.03	72.0 2.83	73.0 2.87	115.0 4.53	77.2	23.0	0.1083	1.52 3.35

<sup>(4)</sup>Negative value indicates effective center inside cone (inner-ring) backface.

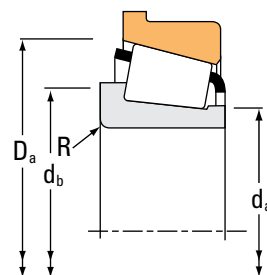
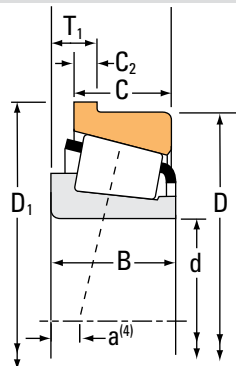
<sup>(5)</sup>These maximum fillet radii will be cleared by the bearing corners.

Continued on next page.

# TAPERED ROLLER BEARINGS

SINGLE-ROW • TYPE TSF

## TYPE TSF



Bearing Dimensions			Load Ratings							Part Number		
Bore d	O.D. D	Width T <sub>1</sub>	Dynamic <sup>(1)</sup>		Factors <sup>(2)</sup>		Dynamic <sup>(3)</sup>		Factors <sup>(2)</sup>	Static C <sub>0</sub>	Inner	Outer
			C <sub>1</sub>	e	Y	C <sub>90</sub>	C <sub>a90</sub>	K	C <sub>0</sub>			
mm in.	mm in.	mm in.	N lbf			N lbf	N lbf		N lbf			
63.500 2.5000	120.000 4.7244	11.095 0.4368	143000 32200	0.38	1.56	37200 8360	24500 5500	1.52	186000 41900		483	472-B
63.500 2.5000	112.712 4.4375	7.917 0.3117	98900 22200	0.40	1.49	25600 5760	17600 3970	1.45	125000 28100		395	3920-B
63.500 2.5000	112.712 4.4375	11.112 0.4375	139000 31200	0.40	1.49	36000 8090	24800 5570	1.45	191000 43000		3982	3920-B
63.500 2.5000	107.950 4.2500	10.320 0.4063	131000 29400	0.46	1.31	33800 7610	26600 5970	1.27	161000 36300		29585	29520-B
63.500 2.5000	104.775 4.1250	10.320 0.4063	115000 25800	0.39	1.55	29700 6680	19700 4440	1.51	120000 27000		39250	39412-B
64.960 2.5575	149.225 5.8750	17.462 0.6875	411000 92400	0.36	1.66	107000 24000	66000 14800	1.61	463000 104000		6464	6420-B
64.963 2.5576	127.000 5.0000	14.288 0.5625	196000 44100	0.36	1.65	50900 11400	31700 7130	1.61	262000 58900		569	563-B
65.000 2.5591	120.000 4.7244	11.095 0.4368	143000 32200	0.38	1.56	37200 8360	24500 5500	1.52	186000 41900		478	472-B
65.087 2.5625	135.755 5.3447	17.462 0.6875	381000 85600	0.32	1.85	98800 22200	54900 12300	1.80	404000 90900		6379	6320-B
65.883 2.5938	122.238 4.8125	13.495 0.5313	280000 63000	0.36	1.67	72700 16300	44600 10000	1.63	327000 73500		5595	5535-B
66.675 2.6250	139.700 5.5000	17.462 0.6875	319000 71700	0.47	1.27	82700 18600	67000 15100	1.24	405000 91000		H715341	H715310-B
66.675 2.6250	136.525 5.3750	16.662 0.6560	276000 62100	0.36	1.66	71600 16100	44400 9980	1.61	298000 67000		641	632-B
66.675 2.6250	135.755 5.3447	17.462 0.6875	321000 72300	0.32	1.85	83300 18700	46300 10400	1.80	404000 90900		6386	6320-B
66.675 2.6250	130.200 5.1260	19.865 0.7821	229000 51500	0.50	1.20	59400 13400	51100 11500	1.16	256000 57600		HM813844	HM813815-B
66.675 2.6250	123.825 4.8750	14.288 0.5625	226000 50800	0.35	1.73	58600 13200	34700 7810	1.69	248000 55700		560	552-B
66.675 2.6250	120.000 4.7244	11.095 0.4368	143000 32200	0.38	1.56	37200 8360	24500 5500	1.52	186000 41900		479	472-B
66.675 2.6250	112.712 4.4375	11.112 0.4375	139000 31200	0.40	1.49	36000 8090	24800 5570	1.45	191000 43000		3984	3920-B

<sup>(1)</sup>Based on 1 x 10<sup>6</sup> revolutions L<sub>10</sub> life, for the ISO life-calculation method.

<sup>(2)</sup>Consult your Timken engineer for instructions on use or review the Timken Engineering Manual on timken.com/catalogs.

<sup>(3)</sup>Based on 90 x 10<sup>6</sup> revolutions L<sub>10</sub> life, for The Timken Company life-calculation method. C<sub>90</sub> and C<sub>a90</sub> are radial and thrust values.

Bearing Dimensions									Geometry Factors			Bearing Weight
Width B	Width C	Eff. Ctr. a <sup>(4)</sup>	Outer Ring Flange O.D. D <sub>1</sub>	Flange Width C <sub>2</sub>	Shaft			Housing	G <sub>1</sub>	G <sub>2</sub>	C <sub>g</sub>	
					Max Shaft Fillet Radius R <sup>(5)</sup>	Backing Shoulder Dia. d <sub>a</sub>	Backing Shoulder Dia. d <sub>b</sub>	Backing Shoulder Dia. D <sub>a</sub>				
mm in.	mm in.	mm in.	mm in.	mm in.	mm in.	mm in.	mm in.	mm in.				kg lbs.
29.007 1.1420	24.237 0.9542	-4.1 -0.16	125.435 4.9384	5.537 0.2180	3.5 0.14	72.0 2.83	78.0 3.07	115.0 4.53	77.2	23.0	0.1083	1.51 3.32
21.996 0.8660	23.812 0.9375	-0.8 -0.03	117.373 4.6210	4.762 0.1875	3.5 0.14	70.0 2.76	77.0 3.03	108.0 4.25	56.0	21.4	0.0984	1.05 2.32
30.048 1.1830	23.812 0.9375	-4.6 -0.18	117.373 4.6210	4.762 0.1875	3.5 0.14	71.0 2.80	77.0 3.03	108.0 4.25	75.2	21.3	0.1092	1.26 2.79
25.400 1.0000	19.050 0.7500	-0.8 -0.03	111.816 4.4022	3.970 0.1563	3.5 0.14	71.0 2.80	77.0 3.03	105.0 4.13	70.3	25.9	0.1112	0.95 2.10
22.000 0.8661	15.875 0.6250	-1.5 -0.06	109.433 4.3084	4.762 0.1875	2.0 0.08	69.0 2.72	73.0 2.87	102.0 4.02	51.7	19.5	0.0947	0.71 1.57
54.229 2.1350	44.450 1.7500	-15.0 -0.59	157.061 6.1835	7.938 0.3125	3.5 0.14	81.0 3.19	87.0 3.43	140.0 5.51	158.3	29.1	0.0931	4.89 10.79
36.170 1.4240	28.575 1.1250	-8.1 -0.32	133.248 5.2460	6.350 0.2500	3.5 0.14	74.0 2.91	81.0 3.19	121.0 4.76	101.3	24.0	0.1167	2.11 4.67
29.007 1.1420	24.237 0.9542	-4.1 -0.16	125.435 4.9384	5.537 0.2180	2.3 0.09	73.0 2.87	77.0 3.03	115.0 4.53	77.2	23.0	0.1083	1.48 3.26
56.007 2.2050	44.450 1.7500	-19.3 -0.76	143.579 5.6527	7.938 0.3125	3.5 0.14	77.0 3.04	84.0 3.31	126.0 4.96	123.5	22.4	0.0827	3.75 8.27
43.764 1.7230	36.512 1.4375	-12.2 -0.48	128.588 5.0625	6.350 0.2500	3.5 0.14	77.0 3.03	83.0 3.27	118.0 4.65	110.4	24.2	0.0825	2.29 5.05
46.038 1.8125	36.512 1.4375	-8.6 -0.34	152.400 6.0000	7.938 0.3125	3.5 0.14	85.0 3.35	91.0 3.58	135.0 5.31	147.1	33.5	0.0993	3.67 8.08
41.275 1.6250	31.750 1.2500	-11.2 -0.44	143.561 5.6520	7.137 0.2810	3.5 0.14	77.0 3.03	83.0 3.27	125.0 4.92	106.4	21.0	0.0814	2.80 6.18
56.007 2.2050	44.450 1.7500	-19.3 -0.76	143.579 5.6527	7.938 0.3125	4.3 0.17	77.0 3.04	87.0 3.43	126.0 4.96	123.5	22.4	0.0827	3.67 8.10
36.512 1.4375	26.988 1.0625	-3.8 -0.15	138.201 5.4410	10.340 0.4071	3.5 0.14	82.0 3.23	88.0 3.46	124.0 4.88	91.7	22.9	0.1252	2.26 4.98
36.678 1.4440	30.162 1.1875	-9.4 -0.37	130.073 5.1210	6.350 0.2500	3.5 0.14	77.0 3.03	84.0 3.31	116.0 4.57	91.0	21.1	0.1108	1.96 4.31
29.007 1.1420	24.237 0.9542	-4.1 -0.16	125.435 4.9384	5.537 0.2180	2.3 0.09	74.0 2.91	78.0 3.07	115.0 4.53	77.2	23.0	0.1083	1.45 3.17
30.048 1.1830	23.812 0.9375	-4.6 -0.18	117.373 4.6210	4.762 0.1875	3.5 0.14	74.0 2.91	80.0 3.15	108.0 4.25	75.2	21.3	0.1092	1.18 2.62

<sup>(4)</sup>Negative value indicates effective center inside cone (inner-ring) backface.

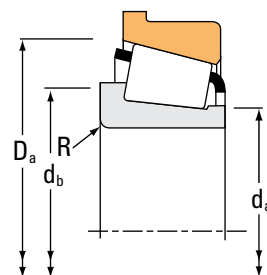
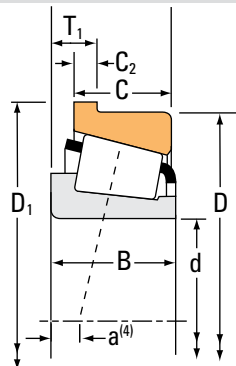
<sup>(5)</sup>These maximum fillet radii will be cleared by the bearing corners.

Continued on next page.

# TAPERED ROLLER BEARINGS

## SINGLE-ROW • TYPE TSF

### TYPE TSF



Bearing Dimensions			Load Ratings							Part Number		
Bore d	O.D. D	Width T <sub>1</sub>	Dynamic <sup>(1)</sup>		Factors <sup>(2)</sup>		Dynamic <sup>(3)</sup>		Factors <sup>(2)</sup>	Static C <sub>0</sub>	Inner	Outer
			C <sub>1</sub>	e	Y	C <sub>90</sub>	C <sub>a90</sub>	K	N lbf			
mm in.	mm in.	mm in.	N lbf			N lbf	N lbf		N lbf			
66.675 2.6250	107.950 4.2500	10.320 0.4063	131000 29400	0.46	1.31	33800 7610	26600 5970	1.27	161000 36300		29590	29520-B
68.262 2.6875	161.925 6.3750	24.600 0.9685	353000 79300	0.71	0.85	91400 20600	111000 24900	0.82	330000 74200		9278	9221-B
68.262 2.6875	136.525 5.3750	16.662 0.6560	233000 52400	0.36	1.66	60400 13600	37400 8420	1.61	298000 67000		642	632-B
68.262 2.6875	127.000 5.0000	14.288 0.5625	196000 44100	0.36	1.65	50900 11400	31700 7130	1.61	262000 58900		570	563-B
68.262 2.6875	120.000 4.7244	11.095 0.4368	143000 32200	0.38	1.56	37200 8360	24500 5500	1.52	186000 41900		480	472-B
68.262 2.6875	110.000 4.3307	7.925 0.3120	98900 22200	0.40	1.49	25600 5760	17600 3970	1.45	125000 28100		399A	394AB
69.850 2.7500	168.275 6.6250	22.225 0.8750	485000 109000	0.30	2.00	126000 28300	64400 14500	1.95	522000 117000		835	832-B
69.850 2.7500	152.400 6.0000	16.667 0.6562	247000 55500	0.41	1.47	64000 14400	44800 10100	1.43	335000 75300		655	652-B
69.850 2.7500	150.089 5.9090	15.875 0.6250	377000 84700	0.33	1.84	97600 21900	54400 12200	1.80	417000 93800		745A	742-B
69.850 2.7500	149.225 5.8750	17.462 0.6875	411000 92400	0.36	1.66	107000 24000	66000 14800	1.61	463000 104000		6454	6420-B
69.850 2.7500	136.525 5.3750	16.662 0.6560	276000 62100	0.36	1.66	71600 16100	44400 9980	1.61	298000 67000		643	632-B
69.850 2.7500	127.000 5.0000	14.288 0.5625	196000 44100	0.36	1.65	50900 11400	31700 7130	1.61	262000 58900		566	563-B
69.850 2.7500	120.000 4.7244	11.095 0.4368	143000 32200	0.38	1.56	37200 8360	24500 5500	1.52	186000 41900		482	472-B
69.850 2.7500	112.712 4.4375	10.320 0.4063	111000 24800	0.49	1.23	28600 6440	23900 5370	1.20	166000 37200		29675	29620-B
69.850 2.7500	112.712 4.4375	11.112 0.4375	101000 22700	0.42	1.44	26200 5880	18600 4190	1.40	130000 29300		LM613449	LM613410-B
69.952 2.7540	122.238 4.8125	7.938 0.3125	102000 23000	0.45	1.33	26500 5960	20500 4600	1.30	136000 30600		34274	34481-B
70.000 2.7559	122.238 4.8125	7.938 0.3125	102000 23000	0.45	1.33	26500 5960	20500 4600	1.30	136000 30600		34275	34481-B

<sup>(1)</sup>Based on 1 x 10<sup>6</sup> revolutions L<sub>10</sub> life, for the ISO life-calculation method.

<sup>(2)</sup>Consult your Timken engineer for instructions on use or review the Timken Engineering Manual on timken.com/catalogs.

<sup>(3)</sup>Based on 90 x 10<sup>6</sup> revolutions L<sub>10</sub> life, for The Timken Company life-calculation method. C<sub>90</sub> and C<sub>a90</sub> are radial and thrust values.

Bearing Dimensions									Geometry Factors			Bearing Weight
Width B	Width C	Eff. Ctr. a <sup>(4)</sup>	Outer Ring Flange O.D. D <sub>1</sub>	Flange Width C <sub>2</sub>	Shaft			Housing	G <sub>1</sub>	G <sub>2</sub>	C <sub>g</sub>	
					Max Shaft Fillet Radius R <sup>(5)</sup>	Backing Shoulder Dia.		Backing Shoulder Dia. D <sub>a</sub>				
mm in.	mm in.	mm in.	mm in.	mm in.	mm in.	mm in.	mm in.	mm in.				kg lbs.
25.400 1.0000	19.050 0.7500	-0.8 -0.03	111.816 4.4022	3.970 0.1563	3.5 0.14	73.0 2.87	80.0 3.15	105.0 4.13	70.3	25.9	0.1112	0.88 1.96
46.038 1.8125	30.162 1.1875	0.0 0.00	171.450 6.7500	7.137 0.2810	3.5 0.14	89.0 3.50	106.0 4.17	153.0 6.03	102.5	16.1	0.0984	4.60 10.13
41.275 1.6250	31.750 1.2500	-11.2 -0.44	143.561 5.6520	7.137 0.2810	3.5 0.14	78.0 3.07	85.0 3.35	125.0 4.92	106.4	21.0	0.0814	2.75 6.06
36.170 1.4240	28.575 1.1250	-8.1 -0.32	133.248 5.2460	6.350 0.2500	3.5 0.14	77.0 3.03	83.0 3.27	121.0 4.76	101.3	24.0	0.1167	2.02 4.45
29.007 1.1420	24.237 0.9542	-4.1 -0.16	125.435 4.9384	5.537 0.2180	3.5 0.14	75.0 2.95	82.0 3.23	115.0 4.53	77.2	23.0	0.1083	1.40 3.08
21.996 0.8660	18.824 0.7411	-0.8 -0.03	114.673 4.5147	4.750 0.1870	2.3 0.09	74.0 2.91	78.0 3.07	106.0 4.17	56.0	21.4	0.0984	0.79 1.73
56.363 2.2190	41.275 1.6250	-18.5 -0.73	177.698 6.9960	9.525 0.3750	3.5 0.14	84.0 3.31	91.0 3.58	155.0 6.10	197.9	34.8	0.0937	6.28 13.84
41.275 1.6250	31.750 1.2500	-7.9 -0.31	159.441 6.2772	7.142 0.2812	3.5 0.14	82.0 3.23	88.0 3.46	141.0 5.55	136.6	27.3	0.0919	3.70 8.17
46.672 1.8375	36.512 1.4375	-11.9 -0.47	157.912 6.2170	7.938 0.3125	3.5 0.14	82.0 3.23	88.0 3.46	143.0 5.63	159.6	26.3	0.0898	4.04 8.89
54.229 2.1350	44.450 1.7500	-15.0 -0.59	157.061 6.1835	7.938 0.3125	5.0 0.20	85.0 3.35	94.0 3.70	140.0 5.51	158.3	29.1	0.0931	4.66 10.28
41.275 1.6250	31.750 1.2500	-11.2 -0.44	143.561 5.6520	7.137 0.2810	3.5 0.14	80.0 3.15	86.0 3.39	125.0 4.92	106.4	21.0	0.0814	2.69 5.93
36.170 1.4240	28.575 1.1250	-8.1 -0.32	133.248 5.2460	6.350 0.2500	3.5 0.14	78.0 3.07	85.0 3.35	121.0 4.76	101.3	24.0	0.1167	1.97 4.34
29.007 1.1420	24.237 0.9542	-4.1 -0.16	125.435 4.9384	5.537 0.2180	3.5 0.14	77.0 3.03	83.0 3.27	115.0 4.53	77.2	23.0	0.1083	1.36 2.99
25.400 1.0000	19.050 0.7500	1.0 0.04	116.586 4.5900	3.970 0.1563	1.5 0.06	77.0 3.03	80.0 3.15	110.0 4.33	77.7	43.3	0.1170	0.98 2.18
21.996 0.8660	15.875 0.6250	0.0 0.00	119.062 4.6875	4.762 0.1875	1.5 0.06	76.0 2.99	78.0 3.07	110.0 4.33	60.3	23.1	0.1019	0.82 1.82
23.012 0.9060	21.430 0.8437	1.5 0.06	126.901 4.9961	4.762 0.1875	2.0 0.08	78.0 3.07	81.0 3.19	118.0 4.65	69.3	27.0	0.1093	1.18 2.60
23.012 0.9060	21.430 0.8437	1.5 0.06	126.901 4.9961	4.762 0.1875	2.0 0.08	78.0 3.07	82.0 3.23	118.0 4.65	69.3	27.0	0.1093	1.18 2.60

<sup>(4)</sup>Negative value indicates effective center inside cone (inner-ring) backface.

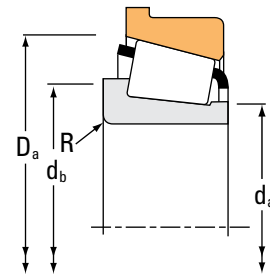
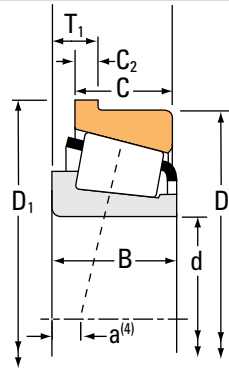
<sup>(5)</sup>These maximum fillet radii will be cleared by the bearing corners.

Continued on next page.

# TAPERED ROLLER BEARINGS

## SINGLE-ROW • TYPE TSF

### TYPE TSF



Bearing Dimensions			Load Ratings							Part Number		
Bore d	O.D. D	Width T <sub>1</sub>	Dynamic <sup>(1)</sup>		Factors <sup>(2)</sup>		Dynamic <sup>(3)</sup>		Factors <sup>(2)</sup>	Static	Inner	Outer
			C <sub>1</sub>	e	Y	C <sub>90</sub>	C <sub>a90</sub>	K	C <sub>0</sub>			
mm in.	mm in.	mm in.	N lbf			N lbf	N lbf			N lbf		
70.000 2.7559	120.000 4.7244	11.095 0.4368	143000 32200	0.38	1.56	37200 8360	24500 5500	1.52		186000 41900	484	472-B
70.000 2.7559	110.000 4.3307	8.500 0.3346	91600 20600	0.46	1.30	23700 5340	18700 4210	1.27		112000 25200	JP7049	JP7010-B
71.437 2.8125	139.700 5.5000	17.462 0.6875	319000 71700	0.47	1.27	82700 18600	67000 15100	1.24		405000 91000	H715345	H715310-B
71.437 2.8125	136.525 5.3750	16.637 0.6550	323000 72600	0.36	1.67	83700 18800	51600 11600	1.62		335000 75400	H414249	H414210-B
71.437 2.8125	136.525 5.3750	16.662 0.6560	276000 62100	0.36	1.66	71600 16100	44400 9980	1.61		298000 67000	645	632-B
71.437 2.8125	127.000 5.0000	14.288 0.5625	196000 44100	0.36	1.65	50900 11400	31700 7130	1.61		262000 58900	567A	563-B
71.437 2.8125	117.475 4.6250	11.112 0.4375	138000 31100	0.44	1.38	35900 8060	26800 6020	1.34		197000 44300	33281	33462-B
73.025 2.8750	152.400 6.0000	16.667 0.6562	247000 55500	0.41	1.47	64000 14400	44800 10100	1.43		335000 75300	657	652-B
73.025 2.8750	149.225 5.8750	17.462 0.6875	411000 92400	0.36	1.66	107000 24000	66000 14800	1.61		463000 104000	6460	6420-B
73.025 2.8750	127.000 5.0000	14.288 0.5625	196000 44100	0.36	1.65	50900 11400	31700 7130	1.61		262000 58900	567	563-B
73.025 2.8750	127.000 5.0000	14.288 0.5625	196000 44100	0.36	1.65	50900 11400	31700 7130	1.61		262000 58900	567X	563-B
73.025 2.8750	117.475 4.6250	11.112 0.4375	118000 26500	0.51	1.18	30600 6870	26700 5990	1.15		183000 41200	LM814845	LM814810-B
73.025 2.8750	112.712 4.4375	10.320 0.4063	111000 24800	0.49	1.23	28600 6440	23900 5370	1.20		166000 37200	29685	29620-B
73.817 2.9062	127.000 5.0000	14.288 0.5625	196000 44100	0.36	1.65	50900 11400	31700 7130	1.61		262000 58900	568	563-B
74.612 2.9375	139.992 5.5115	14.288 0.5625	207000 46500	0.40	1.49	53600 12100	37100 8330	1.45		291000 65400	577	572-B
76.200 3.0000	168.275 6.6250	22.225 0.8750	485000 109000	0.30	2.00	126000 28300	64400 14500	1.95		522000 117000	837	832-B
76.200 3.0000	161.925 6.3750	17.450 0.6870	327000 73600	0.34	1.76	84800 19100	49500 11100	1.71		441000 99200	755	752-B

<sup>(1)</sup>Based on 1 x 10<sup>6</sup> revolutions L<sub>10</sub> life, for the ISO life-calculation method.

<sup>(2)</sup>Consult your Timken engineer for instructions on use or review the Timken Engineering Manual on timken.com/catalogs.

<sup>(3)</sup>Based on 90 x 10<sup>6</sup> revolutions L<sub>10</sub> life, for The Timken Company life-calculation method. C<sub>90</sub> and C<sub>a90</sub> are radial and thrust values.

Bearing Dimensions									Geometry Factors			Bearing Weight
Width B	Width C	Eff. Ctr. a <sup>(4)</sup>	Outer Ring Flange O.D. D <sub>1</sub>	Flange Width C <sub>2</sub>	Shaft			Housing	G <sub>1</sub>	G <sub>2</sub>	C <sub>g</sub>	
					Max Shaft Fillet Radius R <sup>(5)</sup>	Backing Shoulder Dia.		Backing Shoulder Dia. D <sub>a</sub>				
mm in.	mm in.	mm in.	mm in.	mm in.	mm in.	mm in.	mm in.	mm in.				kg lbs.
29.007 1.1420	24.237 0.9542	-4.1 -0.16	125.435 4.9384	5.537 0.2180	2.0 0.08	77.0 3.03	80.0 3.15	115.0 4.53	77.2	23.0	0.1083	1.37 3.00
20.000 0.7874	15.500 0.6102	2.5 0.10	116.000 4.5669	3.000 0.1181	2.0 0.08	76.0 2.99	80.0 3.15	105.4 4.15	51.1	31.0	0.0995	0.70 1.55
46.038 1.8125	36.512 1.4375	-8.6 -0.34	152.400 6.0000	7.938 0.3125	3.5 0.14	88.0 3.46	94.0 3.70	135.0 5.31	147.1	33.5	0.0993	3.48 7.68
41.275 1.6250	31.750 1.2500	-10.9 -0.43	143.637 5.6550	7.112 0.2800	3.5 0.14	83.3 3.27	89.0 3.50	130.0 5.12	112.8	22.9	0.0827	2.66 5.87
41.275 1.6250	31.750 1.2500	-11.2 -0.44	143.561 5.6520	7.137 0.2810	6.4 0.25	81.0 3.19	93.0 3.66	125.0 4.92	106.4	21.0	0.0814	2.61 5.75
36.170 1.4240	28.575 1.1250	-8.1 -0.32	133.248 5.2460	6.350 0.2500	3.5 0.14	80.0 3.15	86.0 3.39	121.0 4.76	101.3	24.0	0.1167	1.92 4.23
30.162 1.1875	23.812 0.9375	-2.8 -0.11	122.133 4.8084	4.762 0.1875	3.5 0.14	80.0 3.15	87.0 3.43	114.0 4.49	84.2	25.9	0.1162	1.30 2.86
41.275 1.6250	31.750 1.2500	-7.9 -0.31	159.441 6.2772	7.142 0.2812	3.5 0.14	85.0 3.35	91.0 3.58	141.0 5.55	136.6	27.3	0.0919	3.59 7.91
54.229 2.1350	44.450 1.7500	-15.0 -0.59	157.061 6.1835	7.938 0.3125	3.5 0.14	87.0 3.43	93.0 3.66	140.0 5.51	158.3	29.1	0.0931	4.52 9.97
36.170 1.4240	28.575 1.1250	-8.1 -0.32	133.248 5.2460	6.350 0.2500	3.5 0.14	81.0 3.19	88.0 3.46	121.0 4.76	101.3	24.0	0.1167	1.87 4.12
36.170 1.4240	28.575 1.1250	-8.1 -0.32	133.248 5.2460	6.350 0.2500	4.8 0.19	81.0 3.19	90.0 3.54	121.0 4.76	101.3	24.0	0.1167	1.87 4.13
25.400 1.0000	19.050 0.7500	2.3 0.09	122.133 4.8084	4.762 0.1875	3.5 0.14	81.0 3.19	87.0 3.43	116.0 4.57	88.6	36.6	0.1239	1.07 2.35
25.400 1.0000	19.050 0.7500	1.0 0.04	116.586 4.5900	3.970 0.1563	3.5 0.14	80.0 3.15	86.0 3.39	110.0 4.33	77.7	43.3	0.1170	0.91 2.02
36.170 1.4240	28.575 1.1250	-8.1 -0.32	133.248 5.2460	6.350 0.2500	0.8 0.03	82.0 3.23	83.0 3.27	121.0 4.76	101.3	24.0	0.1167	1.85 4.09
36.098 1.4212	28.575 1.1250	-5.3 -0.21	146.240 5.7575	6.350 0.2500	3.5 0.14	85.0 3.35	91.0 3.58	134.0 5.28	125.7	32.0	0.1295	2.48 5.47
56.363 2.2190	41.275 1.6250	-18.5 -0.73	177.698 6.9960	9.525 0.3750	0.8 0.03	89.0 3.50	90.0 3.54	155.0 6.10	197.9	34.8	0.0937	5.97 13.15
48.260 1.9000	38.100 1.5000	-11.9 -0.47	169.748 6.6830	7.925 0.3120	3.5 0.14	92.0 3.62	98.0 3.86	150.0 5.91	177.2	29.4	0.0945	4.84 10.66

<sup>(4)</sup>Negative value indicates effective center inside cone (inner-ring) backface.

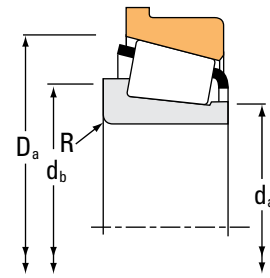
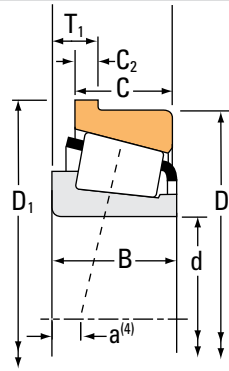
<sup>(5)</sup>These maximum fillet radii will be cleared by the bearing corners.

Continued on next page.

# TAPERED ROLLER BEARINGS

## SINGLE-ROW • TYPE TSF

### TYPE TSF



Bearing Dimensions			Load Ratings							Part Number	
Bore d	O.D. D	Width T <sub>1</sub>	Dynamic <sup>(1)</sup>			Dynamic <sup>(3)</sup>			Static C <sub>0</sub>	Inner	Outer
			C <sub>1</sub>	Factors <sup>(2)</sup> e Y		C <sub>90</sub>	Factors <sup>(2)</sup> K				
mm in.	mm in.	mm in.	N lbf			N lbf	N lbf		N lbf		
76.200 3.0000	161.925 6.3750	19.050 0.7500	439000 98800	0.40	1.50	114000 25600	78100 17600	1.46	523000 118000	6575	6535-B
76.200 3.0000	161.925 6.3750	24.600 0.9685	353000 79300	0.71	0.85	91400 20600	111000 24900	0.82	330000 74200	9285	9221-B
76.200 3.0000	149.225 5.8750	17.462 0.6875	411000 92400	0.36	1.66	107000 24000	66000 14800	1.61	463000 104000	6461	6420-B
76.200 3.0000	139.992 5.5115	14.288 0.5625	207000 46500	0.40	1.49	53600 12100	37100 8330	1.45	291000 65400	575	572-B
76.200 3.0000	136.525 5.3750	13.475 0.5305	154000 34700	0.44	1.35	40000 9000	30500 6850	1.31	216000 48600	495A	493-B
76.200 3.0000	130.000 5.1181	13.495 0.5313	161000 36200	0.42	1.43	41800 9390	29900 6730	1.39	222000 49800	42687	42623-B
76.200 3.0000	125.412 4.9375	10.317 0.4062	117000 26300	0.42	1.44	30400 6830	21600 4860	1.40	178000 39900	27684	27620-B
76.200 3.0000	122.238 4.8125	7.938 0.3125	102000 23000	0.45	1.33	26500 5960	20500 4600	1.30	136000 30600	34300	34481-B
76.200 3.0000	122.238 4.8125	7.940 0.3126	102000 23000	0.45	1.33	26500 5960	20500 4600	1.30	136000 30600	34301	34481-B
77.788 3.0625	127.000 5.0000	13.495 0.5313	161000 36200	0.42	1.43	41800 9390	29900 6730	1.39	222000 49800	42690	42620-B
77.788 3.0625	122.238 4.8125	7.938 0.3125	121000 27200	0.45	1.33	31400 7060	24200 5450	1.30	136000 30600	34306	34481-B
77.788 3.0625	117.475 4.6250	11.112 0.4375	118000 26500	0.51	1.18	30600 6870	26700 5990	1.15	183000 41200	LM814849	LM814810-B
79.375 3.1250	152.400 6.0000	15.875 0.6250	216000 48600	0.44	1.36	56000 12600	42400 9530	1.32	319000 71600	595A	592-B
79.985 3.1490	152.400 6.0000	15.875 0.6250	216000 48600	0.44	1.36	56000 12600	42400 9530	1.32	319000 71600	590	592-B
80.000 3.1496	125.000 4.9213	10.500 0.4134	107000 24000	0.45	1.33	27700 6230	21400 4820	1.29	141000 31800	JP8049	JP8010-B
80.962 3.1875	168.275 6.6250	22.225 0.8750	409000 92000	0.30	2.00	106000 23800	54300 12200	1.95	522000 117000	838	832-B
80.962 3.1875	139.992 5.5115	14.288 0.5625	207000 46500	0.40	1.49	53600 12100	37100 8330	1.45	291000 65400	581	572-B

<sup>(1)</sup>Based on 1 x 10<sup>6</sup> revolutions L<sub>10</sub> life, for the ISO life-calculation method.

<sup>(2)</sup>Consult your Timken engineer for instructions on use or review the Timken Engineering Manual on timken.com/catalogs.

<sup>(3)</sup>Based on 90 x 10<sup>6</sup> revolutions L<sub>10</sub> life, for The Timken Company life-calculation method. C<sub>90</sub> and C<sub>a90</sub> are radial and thrust values.



Bearing Dimensions									Geometry Factors			Bearing Weight
Width B	Width C	Eff. Ctr. a <sup>(4)</sup>	Outer Ring Flange O.D. D <sub>1</sub>	Flange Width C <sub>2</sub>	Shaft			Housing	G <sub>1</sub>	G <sub>2</sub>	C <sub>g</sub>	
					Max Shaft Fillet Radius R <sup>(5)</sup>	Backing Shoulder Dia.		Backing Shoulder Dia. D <sub>a</sub>				
mm in.	mm in.	mm in.	mm in.	mm in.	mm in.	mm in.	mm in.	mm in.				kg lbs.
55.100 2.1693	42.862 1.6875	-13.2 -0.52	171.450 6.7500	7.938 0.3125	6.4 0.25	92.0 3.62	104.0 4.09	155.0 6.10	198.6	33.5	0.1037	5.47 12.07
46.038 1.8125	30.162 1.1875	0.0 0.00	171.450 6.7500	7.137 0.2810	3.5 0.14	89.0 3.50	111.0 4.37	153.0 6.03	102.5	16.1	0.0984	4.27 9.41
54.229 2.1350	44.450 1.7500	-15.0 -0.59	157.061 6.1835	7.938 0.3125	3.5 0.14	89.0 3.52	96.0 3.78	140.0 5.51	158.3	29.1	0.0931	4.36 9.63
36.098 1.4212	28.575 1.1250	-5.3 -0.21	146.240 5.7575	6.350 0.2500	3.5 0.14	86.0 3.39	92.0 3.62	134.0 5.28	125.7	32.0	0.1295	2.42 5.35
29.769 1.1720	22.225 0.8750	-0.8 -0.03	141.961 5.5890	5.537 0.2180	3.5 0.14	86.0 3.39	92.0 3.62	131.0 5.16	104.6	29.3	0.1252	1.86 4.09
31.000 1.2205	22.225 0.8750	-2.8 -0.11	135.456 5.3329	5.558 0.2188	3.5 0.14	84.0 3.31	90.0 3.54	124.0 4.88	96.2	28.6	0.1197	1.61 3.55
25.400 1.0000	19.845 0.7813	0.5 0.02	130.076 5.1211	4.762 0.1875	3.5 0.14	84.0 3.31	91.0 3.58	123.0 4.84	98.2	41.8	0.1198	1.25 2.76
23.012 0.9060	21.430 0.8437	1.5 0.06	126.901 4.9961	4.762 0.1875	2.0 0.08	83.0 3.27	86.0 3.39	118.0 4.65	69.3	27.0	0.1093	1.05 2.32
23.012 0.9060	21.430 0.8437	1.5 0.06	126.901 4.9961	4.762 0.1875	3.5 0.14	83.0 3.27	89.0 3.50	118.0 4.65	69.3	27.0	0.1093	1.04 2.30
31.000 1.2205	22.225 0.8750	-2.8 -0.11	133.248 5.2460	5.558 0.2188	3.5 0.14	85.0 3.35	91.0 3.58	124.0 4.88	96.2	28.6	0.1197	1.43 3.14
23.012 0.9060	21.430 0.8437	1.5 0.06	126.901 4.9961	4.762 0.1875	3.5 0.14	84.0 3.31	91.0 3.58	118.0 4.65	69.3	27.0	0.1093	1.00 2.22
25.400 1.0000	19.050 0.7500	2.3 0.09	122.133 4.8084	4.762 0.1875	3.5 0.14	85.0 3.35	91.0 3.58	116.0 4.57	88.6	36.6	0.1239	0.96 2.11
36.322 1.4300	30.162 1.1875	-2.5 -0.10	158.648 6.2460	6.350 0.2500	3.5 0.14	91.0 3.58	98.0 3.86	144.0 5.67	151.4	38.3	0.1416	3.18 7.00
36.322 1.4300	30.162 1.1875	-2.5 -0.10	158.648 6.2460	6.350 0.2500	3.5 0.14	91.0 3.58	98.0 3.86	144.0 5.67	151.4	38.3	0.1416	3.16 6.95
22.500 0.8858	17.500 0.6890	2.3 0.09	132.000 5.1969	4.000 0.1575	2.0 0.08	86.0 3.39	89.0 3.50	129.0 5.08	69.7	37.4	0.1095	1.02 2.22
56.363 2.2190	41.275 1.6250	-18.5 -0.73	177.698 6.9960	9.525 0.3750	0.8 0.03	93.0 3.66	94.0 3.70	155.0 6.10	197.9	34.8	0.0937	5.71 12.58
36.098 1.4212	28.575 1.1250	-5.3 -0.21	146.240 5.7575	6.350 0.2500	3.5 0.14	90.0 3.54	96.0 3.78	134.0 5.28	125.7	32.0	0.1295	2.26 4.98

<sup>(4)</sup>Negative value indicates effective center inside cone (inner-ring) backface.

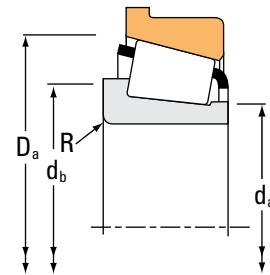
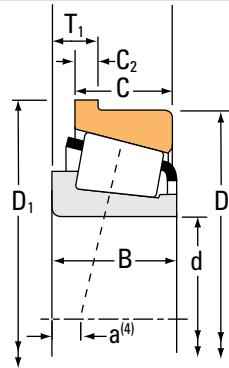
<sup>(5)</sup>These maximum fillet radii will be cleared by the bearing corners.

Continued on next page.

# TAPERED ROLLER BEARINGS

## SINGLE-ROW • TYPE TSF

### TYPE TSF



Bearing Dimensions			Load Ratings							Part Number		
Bore d	O.D. D	Width T <sub>1</sub>	Dynamic <sup>(1)</sup>		Factors <sup>(2)</sup>		Dynamic <sup>(3)</sup>		Factors <sup>(2)</sup>	Static C <sub>0</sub>	Inner	Outer
			C <sub>1</sub>	e	Y	C <sub>90</sub>	C <sub>a90</sub>	K	C <sub>0</sub>			
mm in.	mm in.	mm in.	N lbf			N lbf	N lbf		N lbf			
80.962 3.1875	136.525 5.3750	13.475 0.5305	154000 34700	0.44	1.35	40000 9000	30500 6850	1.31	216000 48600		496	493-B
80.962 3.1875	133.350 5.2500	12.700 0.5000	214000 48100	0.40	1.48	55500 12500	38400 8640	1.44	262000 58900		47681	47620-B
82.550 3.2500	168.275 6.6250	22.225 0.8750	409000 92000	0.30	2.00	106000 23800	54300 12200	1.95	522000 117000		839	832-B
82.550 3.2500	168.275 6.6250	22.225 0.8750	485000 109000	0.30	2.00	126000 28300	64400 14500	1.95	522000 117000		842	832-B
82.550 3.2500	161.925 6.3750	17.450 0.6870	327000 73600	0.34	1.76	84800 19100	49500 11100	1.71	441000 99200		757	752-B
82.550 3.2500	152.400 6.0000	15.875 0.6250	216000 48600	0.44	1.36	56000 12600	42400 9530	1.32	319000 71600		595	592-B
82.550 3.2500	152.400 6.0000	16.667 0.6562	247000 55500	0.41	1.47	64000 14400	44800 10100	1.43	335000 75300		663	652-B
82.550 3.2500	139.992 5.5115	14.288 0.5625	207000 46500	0.40	1.49	53600 12100	37100 8330	1.45	291000 65400		580	572-B
82.550 3.2500	136.525 5.3750	13.475 0.5305	154000 34700	0.44	1.35	40000 9000	30500 6850	1.31	216000 48600		495	493-B
82.550 3.2500	133.350 5.2500	12.700 0.5000	214000 48100	0.40	1.48	55500 12500	38400 8640	1.44	262000 58900		47686	47620-B
82.550 3.2500	133.350 5.2500	12.700 0.5000	214000 48100	0.40	1.48	55500 12500	38400 8640	1.44	262000 58900		47685	47620-B
82.550 3.2500	125.412 4.9375	10.317 0.4062	117000 26300	0.42	1.44	30400 6830	21600 4860	1.40	178000 39900		27687	27620-B
82.550 3.2500	115.888 4.5625	7.938 0.3125	90200 20300	0.31	1.95	23400 5260	12300 2770	1.90	147000 33100		L116149	L116110-B
83.345 3.2813	125.412 4.9375	10.317 0.4062	117000 26300	0.42	1.44	30400 6830	21600 4860	1.40	178000 39900		27690	27620-B
84.138 3.3125	136.525 5.3750	13.475 0.5305	154000 34700	0.44	1.35	40000 9000	30500 6850	1.31	216000 48600		498	493-B
85.000 3.3465	130.000 5.1181	11.557 0.4550	161000 36300	0.44	1.35	41800 9400	31800 7150	1.31	245000 55100		JM716649	JM716610-B
85.725 3.3750	168.275 6.6250	18.255 0.7187	265000 59500	0.47	1.28	68600 15400	55300 12400	1.24	386000 86700		677	672-B

<sup>(1)</sup>Based on  $1 \times 10^6$  revolutions  $L_{10}$  life, for the ISO life-calculation method.

<sup>(2)</sup>Consult your Timken engineer for instructions on use or review the Timken Engineering Manual on [timken.com/catalogs](http://timken.com/catalogs).

<sup>(3)</sup>Based on  $90 \times 10^6$  revolutions  $L_{10}$  life, for The Timken Company life-calculation method.  $C_{90}$  and  $C_{a90}$  are radial and thrust values.

Bearing Dimensions									Geometry Factors			Bearing Weight
Width B	Width C	Eff. Ctr. a <sup>(4)</sup>	Outer Ring Flange O.D. D <sub>1</sub>	Flange Width C <sub>2</sub>	Shaft			Housing	G <sub>1</sub>	G <sub>2</sub>	C <sub>g</sub>	
					Max Shaft Fillet Radius R <sup>(5)</sup>	Backing Shoulder Dia.		Backing Shoulder Dia. D <sub>a</sub>				
mm in.	mm in.	mm in.	mm in.	mm in.	mm in.	mm in.	mm in.	mm in.				kg lbs.
29.769 1.1720	22.225 0.8750	-0.8 -0.03	141.961 5.5890	5.537 0.2180	3.5 0.14	89.0 3.50	95.0 3.74	131.0 5.16	104.6	29.3	0.1252	1.72 3.79
33.338 1.3125	26.195 1.0313	-4.3 -0.17	138.811 5.4650	5.558 0.2188	3.5 0.14	89.0 3.50	95.0 3.74	130.0 5.12	119.4	29.2	0.1273	1.90 4.18
56.363 2.2190	41.275 1.6250	-18.5 -0.73	177.698 6.9960	9.525 0.3750	0.8 0.03	94.0 3.70	95.0 3.74	155.0 6.10	197.9	34.8	0.0937	5.62 12.38
56.363 2.2190	41.275 1.6250	-18.5 -0.73	177.698 6.9960	9.525 0.3750	3.5 0.14	94.0 3.70	101.0 3.98	155.0 6.10	197.9	34.8	0.0937	5.60 12.35
48.260 1.9000	38.100 1.5000	-11.9 -0.47	169.748 6.6830	7.925 0.3120	3.5 0.14	94.0 3.70	100.0 3.94	150.0 5.91	177.2	29.4	0.0945	4.53 9.98
36.322 1.4300	30.162 1.1875	-2.5 -0.10	158.648 6.2460	6.350 0.2500	3.5 0.14	93.0 3.66	100.0 3.94	144.0 5.67	151.4	38.3	0.1416	3.06 6.75
41.275 1.6250	31.750 1.2500	-7.9 -0.31	159.441 6.2772	7.142 0.2812	3.5 0.14	92.0 3.62	99.0 3.90	141.0 5.55	136.6	27.3	0.0919	3.21 7.08
36.098 1.4212	28.575 1.1250	-5.3 -0.21	146.240 5.7575	6.350 0.2500	3.5 0.14	91.0 3.58	98.0 3.86	134.0 5.28	125.7	32.0	0.1295	2.20 4.87
29.769 1.1720	22.225 0.8750	-0.8 -0.03	141.961 5.5890	5.537 0.2180	3.5 0.14	90.0 3.54	97.0 3.82	131.0 5.16	104.6	29.3	0.1252	1.67 3.68
33.338 1.3125	26.195 1.0313	-4.3 -0.17	138.811 5.4650	5.558 0.2188	3.5 0.14	92.0 3.62	98.0 3.86	130.0 5.12	119.4	29.2	0.1273	1.85 4.08
33.338 1.3125	26.195 1.0313	-4.3 -0.17	138.811 5.4650	5.558 0.2188	0.8 0.03	90.0 3.54	91.0 3.58	130.0 5.12	119.4	29.2	0.1273	1.86 4.09
25.400 1.0000	19.845 0.7813	0.5 0.02	130.076 5.1211	4.762 0.1875	3.5 0.14	89.0 3.50	96.0 3.78	123.0 4.84	98.2	41.8	0.1198	1.10 2.43
21.433 0.8438	16.670 0.6563	-1.3 -0.05	119.855 4.7187	3.970 0.1563	1.5 0.06	87.0 3.43	90.0 3.54	113.0 4.45	97.2	64.3	0.1079	0.68 1.51
25.400 1.0000	19.845 0.7813	0.5 0.02	130.076 5.1211	4.762 0.1875	3.5 0.14	89.0 3.50	96.0 3.78	123.0 4.84	98.2	41.8	0.1198	1.08 2.38
29.769 1.1720	22.225 0.8750	-0.8 -0.03	141.961 5.5890	5.537 0.2180	3.5 0.14	91.0 3.58	98.0 3.86	131.0 5.16	104.6	29.3	0.1252	1.62 3.57
29.000 1.1417	24.000 0.9449	-0.3 -0.01	135.448 5.3346	5.558 0.2188	3.0 0.12	92.0 3.62	98.0 3.86	127.0 5.00	117.1	38.4	0.1303	1.39 3.07
41.275 1.6250	30.162 1.1875	-2.8 -0.11	175.336 6.9030	7.142 0.2812	3.5 0.14	99.0 3.90	105.0 4.13	160.0 6.30	182.5	37.3	0.1056	4.23 9.33

<sup>(4)</sup>Negative value indicates effective center inside cone (inner-ring) backface.

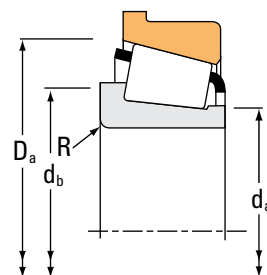
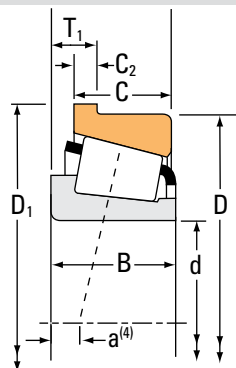
<sup>(5)</sup>These maximum fillet radii will be cleared by the bearing corners.

Continued on next page.

# TAPERED ROLLER BEARINGS

## SINGLE-ROW • TYPE TSF

### TYPE TSF



Bearing Dimensions			Load Ratings							Part Number		
Bore d	O.D. D	Width T <sub>1</sub>	Dynamic <sup>(1)</sup>		Factors <sup>(2)</sup>		Dynamic <sup>(3)</sup>		Factors <sup>(2)</sup>	Static C <sub>0</sub>	Inner	Outer
			C <sub>1</sub>	e	Y	C <sub>90</sub>	C <sub>a90</sub>	K	C <sub>0</sub>			
mm in.	mm in.	mm in.	N lbf			N lbf	N lbf		N lbf			
85.725 3.3750	168.275 6.6250	22.225 0.8750	485000 109000	0.30	2.00	126000 28300	64400 14500	1.95	522000 117000		841	832-B
85.725 3.3750	161.925 6.3750	17.450 0.6870	327000 73600	0.34	1.76	84800 19100	49500 11100	1.71	441000 99200		758	752-B
85.725 3.3750	152.400 6.0000	15.875 0.6250	216000 48600	0.44	1.36	56000 12600	42400 9530	1.32	319000 71600		596	592-B
85.725 3.3750	152.400 6.0000	16.667 0.6562	247000 55500	0.41	1.47	64000 14400	44800 10100	1.43	335000 75300		665	652-B
85.725 3.3750	136.525 5.3750	13.475 0.5305	154000 34700	0.44	1.35	40000 9000	30500 6850	1.31	216000 48600		497	493-B
87.312 3.4375	152.400 6.0000	15.875 0.6250	216000 48600	0.44	1.36	56000 12600	42400 9530	1.32	319000 71600		596-S	592-B
88.900 3.5000	200.000 7.8740	27.361 1.0772	482000 108000	0.63	0.95	125000 28100	135000 30400	0.92	519000 117000		98350	98788-B
88.900 3.5000	190.500 7.5000	22.225 0.8750	458000 103000	0.33	1.79	119000 26700	68000 15300	1.74	630000 142000		855	854-B
88.900 3.5000	190.500 7.5000	22.225 0.8750	534000 120000	0.33	1.79	138000 31100	79300 17800	1.74	692000 156000		HH221434	HH221410-B
88.900 3.5000	180.975 7.1250	17.462 0.6875	346000 77800	0.39	1.56	89700 20200	59200 13300	1.51	495000 111000		775	772-B
88.900 3.5000	168.275 6.6250	18.255 0.7187	265000 59500	0.47	1.28	68600 15400	55300 12400	1.24	386000 86700		679	672-B
88.900 3.5000	161.925 6.3750	17.450 0.6870	327000 73600	0.34	1.76	84800 19100	49500 11100	1.71	441000 99200		766	752-B
88.900 3.5000	161.925 6.3750	17.462 0.6875	327000 73600	0.34	1.76	84800 19100	49500 11100	1.71	441000 99200		759	752-B
88.900 3.5000	161.925 6.3750	19.050 0.7500	439000 98800	0.40	1.50	114000 25600	78100 17600	1.46	523000 118000		6580	6535-B
88.900 3.5000	152.400 6.0000	15.875 0.6250	216000 48600	0.44	1.36	56000 12600	42400 9530	1.32	319000 71600		593	592-B
88.900 3.5000	149.225 5.8750	12.700 0.5000	193000 43400	0.49	1.22	50100 11300	42200 9480	1.19	241000 54300		42350	42587-B
90.000 3.5433	135.000 5.3150	10.500 0.4134	128000 28800	0.49	1.21	33300 7480	28100 6330	1.18	155000 34900		JP9049	JP9010-B

<sup>(1)</sup>Based on  $1 \times 10^6$  revolutions  $L_{10}$  life, for the ISO life-calculation method.

<sup>(2)</sup>Consult your Timken engineer for instructions on use or review the Timken Engineering Manual on [timken.com/catalogs](http://timken.com/catalogs).

<sup>(3)</sup>Based on  $90 \times 10^6$  revolutions  $L_{10}$  life, for The Timken Company life-calculation method.  $C_{90}$  and  $C_{a90}$  are radial and thrust values.

Bearing Dimensions									Geometry Factors			Bearing Weight
Width B	Width C	Eff. Ctr. a <sup>(4)</sup>	Outer Ring Flange O.D. D <sub>1</sub>	Flange Width C <sub>2</sub>	Shaft			Housing	G <sub>1</sub>	G <sub>2</sub>	C <sub>g</sub>	
					Max Shaft Fillet Radius R <sup>(5)</sup>	Backing Shoulder Dia.		Backing Shoulder Dia. D <sub>a</sub>				
mm in.	mm in.	mm in.	mm in.	mm in.	mm in.	mm in.	mm in.	mm in.				kg lbs.
56.363 2.2190	41.275 1.6250	-18.5 -0.73	177.698 6.9960	9.525 0.3750	3.5 0.14	97.0 3.82	104.0 4.09	155.0 6.10	197.9	34.8	0.0937	5.42 11.95
48.260 1.9000	38.100 1.5000	-11.9 -0.47	169.748 6.6830	7.925 0.3120	3.5 0.14	100.0 3.94	106.0 4.17	150.0 5.91	177.2	29.4	0.0945	4.38 9.65
36.322 1.4300	30.162 1.1875	-2.5 -0.10	158.648 6.2460	6.350 0.2500	3.5 0.14	96.0 3.78	102.0 4.02	144.0 5.67	151.4	38.3	0.1416	2.94 6.48
41.275 1.6250	31.750 1.2500	-7.9 -0.31	159.441 6.2772	7.142 0.2812	3.5 0.14	95.0 3.74	102.0 4.02	141.0 5.55	136.6	27.3	0.0919	3.07 6.77
29.769 1.1720	22.225 0.8750	-0.8 -0.03	141.961 5.5890	5.537 0.2180	3.5 0.14	93.0 3.66	99.0 3.90	131.0 5.16	104.6	29.3	0.1252	1.57 3.46
36.322 1.4300	30.162 1.1875	-2.5 -0.10	158.648 6.2460	6.350 0.2500	3.5 0.14	97.0 3.82	103.0 4.06	144.0 5.67	151.4	38.3	0.1416	2.88 6.35
49.212 1.9375	34.925 1.3750	1.3 0.05	209.550 8.2500	9.525 0.3750	3.5 0.14	112.0 4.41	118.0 4.65	188.0 7.40	203.4	37.5	0.1197	7.72 17.02
57.531 2.2650	44.450 1.7500	-15.2 -0.60	199.923 7.8710	9.525 0.3750	8.0 0.31	103.0 4.06	118.0 4.65	174.0 6.85	264.1	44.9	0.1072	7.88 17.39
57.531 2.2650	46.038 1.8125	-15.0 -0.59	199.923 7.8710	11.112 0.4375	8.0 0.31	105.0 4.13	120.0 4.72	179.0 7.05	265.6	28.4	0.1072	8.05 17.72
48.006 1.8900	38.100 1.5000	-8.1 -0.32	188.798 7.4330	7.938 0.3125	4.8 0.19	103.0 4.06	112.0 4.41	168.0 6.61	227.3	41.3	0.1067	5.88 12.97
41.275 1.6250	30.162 1.1875	-2.8 -0.11	175.336 6.9030	7.142 0.2812	3.5 0.14	101.0 3.98	107.0 4.21	160.0 6.30	182.5	37.3	0.1056	4.09 9.02
48.260 1.9000	38.100 1.5000	-11.9 -0.47	169.748 6.6830	7.925 0.3120	7.0 0.28	99.0 3.90	113.0 4.45	150.0 5.91	177.2	29.4	0.0945	4.17 9.17
48.260 1.9000	38.100 1.5000	-11.9 -0.47	169.748 6.6830	7.925 0.3120	3.5 0.14	101.0 3.98	108.0 4.25	150.0 5.91	177.2	29.4	0.0945	4.22 9.28
55.100 2.1693	42.862 1.6875	-13.2 -0.52	171.450 6.7500	7.938 0.3125	3.5 0.14	102.0 4.02	117.0 4.61	155.0 6.10	198.6	33.5	0.1037	4.77 10.53
36.322 1.4300	30.162 1.1875	-2.5 -0.10	158.648 6.2460	6.350 0.2500	3.5 0.14	98.0 3.86	104.0 4.09	144.0 5.67	151.4	38.3	0.1416	2.82 6.21
28.971 1.1406	24.608 0.9688	3.0 0.12	154.681 6.0898	5.558 0.2188	3.0 0.12	98.0 3.86	104.0 4.09	152.0 5.98	129.7	37.2	0.1386	2.14 4.72
22.500 0.8858	17.500 0.6890	5.6 0.22	142.000 5.5906	4.000 0.1575	2.0 0.08	97.0 3.82	100.0 3.94	133.0 5.24	83.8	46.1	0.1196	1.13 2.49

<sup>(4)</sup>Negative value indicates effective center inside cone (inner-ring) backface.

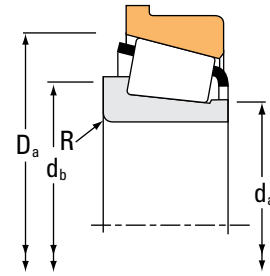
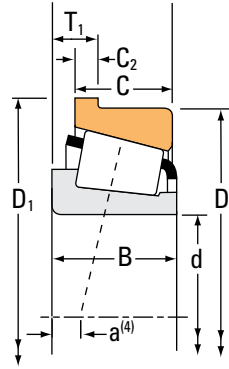
<sup>(5)</sup>These maximum fillet radii will be cleared by the bearing corners.

Continued on next page.

# TAPERED ROLLER BEARINGS

## SINGLE-ROW • TYPE TSF

### TYPE TSF



Bearing Dimensions			Load Ratings							Part Number	
Bore d	O.D. D	Width T <sub>1</sub>	Dynamic <sup>(1)</sup>			Dynamic <sup>(3)</sup>			Static C <sub>0</sub>	Inner	Outer
			C <sub>1</sub>	e	Y	C <sub>90</sub>	C <sub>a90</sub>	K			
mm in.	mm in.	mm in.	N lbf			N lbf	N lbf		N lbf		
90.488 3.5625	161.925 6.3750	17.450 0.6870	327000 73600	0.34	1.76	84800 19100	49500 11100	1.71	441000 99200	760	752-B
92.075 3.6250	168.275 6.6250	18.255 0.7187	265000 59500	0.47	1.28	68600 15400	55300 12400	1.24	386000 86700	681	672-B
92.075 3.6250	152.400 6.0000	15.875 0.6250	216000 48600	0.44	1.36	56000 12600	42400 9530	1.32	319000 71600	598	592-B
92.075 3.6250	149.225 5.8750	12.700 0.5000	163000 36600	0.49	1.22	42200 9490	35600 8000	1.19	241000 54300	42362	42587-B
92.075 3.6250	142.875 5.6250	15.080 0.5937	197000 44300	0.45	1.34	51100 11500	39200 8810	1.30	307000 69000	47890	47825-B
93.662 3.6875	152.400 6.0000	15.875 0.6250	216000 48600	0.44	1.36	56000 12600	42400 9530	1.32	319000 71600	597	592-B
93.662 3.6875	149.225 5.8750	12.700 0.5000	193000 43400	0.49	1.22	50100 11300	42200 9480	1.19	241000 54300	42368	42587-B
95.250 3.7500	190.500 7.5000	22.225 0.8750	458000 103000	0.33	1.79	119000 26700	68000 15300	1.74	630000 142000	864	854-B
95.250 3.7500	190.500 7.5000	22.225 0.8750	534000 120000	0.33	1.79	138000 31100	79300 17800	1.74	692000 156000	HH221440	HH221410-B
95.250 3.7500	180.975 7.1250	17.462 0.6875	346000 77800	0.39	1.56	89700 20200	59200 13300	1.51	495000 111000	776	772-B
95.250 3.7500	180.975 7.1250	17.462 0.6875	346000 77800	0.39	1.56	89700 20200	59200 13300	1.51	495000 111000	777	772-B
95.250 3.7500	171.450 6.7500	17.462 0.6875	403000 90500	0.37	1.63	104000 23500	65600 14700	1.59	474000 107000	77375	77675-B
95.250 3.7500	168.275 6.6250	18.255 0.7187	265000 59500	0.47	1.28	68600 15400	55300 12400	1.24	386000 86700	683	672-B
95.250 3.7500	161.925 6.3750	16.667 0.6562	223000 50200	0.47	1.26	57900 13000	47100 10600	1.23	343000 77000	52375	52637-B
95.250 3.7500	160.000 6.2992	16.667 0.6562	223000 50200	0.47	1.26	57900 13000	47100 10600	1.23	343000 77000	52375	52630XB
95.250 3.7500	152.400 6.0000	15.875 0.6250	216000 48600	0.44	1.36	56000 12600	42400 9530	1.32	319000 71600	594	592-B
95.250 3.7500	149.225 5.8750	12.700 0.5000	193000 43400	0.49	1.22	50100 11300	42200 9480	1.19	241000 54300	42375	42587-B

<sup>(1)</sup>Based on  $1 \times 10^6$  revolutions  $L_{10}$  life, for the ISO life-calculation method.

<sup>(2)</sup>Consult your Timken engineer for instructions on use or review the Timken Engineering Manual on [timken.com/catalogs](http://timken.com/catalogs).

<sup>(3)</sup>Based on  $90 \times 10^6$  revolutions  $L_{10}$  life, for The Timken Company life-calculation method.  $C_{90}$  and  $C_{a90}$  are radial and thrust values.

Bearing Dimensions									Geometry Factors			Bearing Weight
Width B	Width C	Eff. Ctr. a <sup>(4)</sup>	Outer Ring Flange O.D. D <sub>1</sub>	Flange Width C <sub>2</sub>	Shaft			Housing	G <sub>1</sub>	G <sub>2</sub>	C <sub>g</sub>	
					Max Shaft Fillet Radius R <sup>(5)</sup>	Backing Shoulder Dia. d <sub>a</sub>	Backing Shoulder Dia. d <sub>b</sub>	Backing Shoulder Dia. D <sub>a</sub>				
mm in.	mm in.	mm in.	mm in.	mm in.	mm in.	mm in.	mm in.	mm in.				kg lbs.
48.260 1.9000	38.100 1.5000	-11.9 -0.47	169.748 6.6830	7.925 0.3120	3.5 0.14	101.0 3.98	110.0 4.33	150.0 5.91	177.2	29.4	0.0945	4.13 9.10
41.275 1.6250	30.162 1.1875	-2.8 -0.11	175.336 6.9030	7.142 0.2812	3.5 0.14	104.0 4.09	110.0 4.33	160.0 6.30	182.5	37.3	0.1056	3.94 8.70
36.322 1.4300	30.162 1.1875	-2.5 -0.10	158.648 6.2460	6.350 0.2500	3.5 0.14	101.0 3.98	107.0 4.21	144.0 5.67	151.4	38.3	0.1416	2.69 5.93
28.971 1.1406	24.608 0.9688	3.0 0.12	154.681 6.0898	5.558 0.2188	3.5 0.14	101.0 3.98	107.0 4.21	152.0 5.98	129.7	37.2	0.1386	2.04 4.48
34.925 1.3750	26.195 1.0313	-1.0 -0.04	149.123 5.8710	7.938 0.3125	3.5 0.14	101.0 3.98	107.0 4.21	142.0 5.59	153.2	38.1	0.1428	2.01 4.43
36.322 1.4300	30.162 1.1875	-2.5 -0.10	158.648 6.2460	6.350 0.2500	3.5 0.14	102.0 4.02	109.0 4.29	144.0 5.67	151.4	38.3	0.1416	2.62 5.78
28.971 1.1406	24.608 0.9688	3.0 0.12	154.681 6.0898	5.558 0.2188	3.0 0.12	102.0 4.02	107.0 4.21	152.0 5.98	129.7	37.2	0.1386	1.99 4.38
57.531 2.2650	44.450 1.7500	-15.2 -0.60	199.923 7.8710	9.525 0.3750	8.0 0.31	108.0 4.25	123.0 4.84	174.0 6.85	264.1	44.9	0.1072	7.46 16.46
57.531 2.2650	46.038 1.8125	-15.0 -0.59	199.923 7.8710	11.112 0.4375	8.0 0.31	110.0 4.33	125.0 4.92	179.0 7.05	265.6	28.4	0.1072	7.63 16.80
48.006 1.8900	38.100 1.5000	-8.1 -0.32	188.798 7.4330	7.938 0.3125	3.5 0.14	107.0 4.21	114.0 4.49	168.0 6.61	227.3	41.3	0.1067	5.55 12.23
48.006 1.8900	38.100 1.5000	-8.1 -0.32	188.798 7.4330	7.938 0.3125	9.7 0.38	107.0 4.21	126.0 4.96	168.0 6.61	227.3	41.3	0.1067	5.45 12.02
48.260 1.9000	38.100 1.5000	-9.7 -0.38	179.283 7.0584	7.938 0.3125	3.5 0.14	106.0 4.17	113.0 4.45	161.0 6.34	206.2	37.7	0.1017	4.72 10.40
41.275 1.6250	30.162 1.1875	-2.8 -0.11	175.336 6.9030	7.142 0.2812	3.5 0.14	106.0 4.17	113.0 4.45	160.0 6.30	182.5	37.3	0.1056	3.79 8.36
36.116 1.4219	26.195 1.0313	-0.5 -0.02	168.173 6.6210	6.350 0.2500	3.5 0.14	105.0 4.13	112.0 4.41	155.0 6.10	175.4	41.7	0.1519	2.99 6.59
36.116 1.4219	26.195 1.0313	-0.5 -0.02	166.345 6.5490	6.350 0.2500	3.5 0.14	105.0 4.13	112.0 4.41	155.0 6.10	175.4	41.7	0.1519	2.91 6.41
36.322 1.4300	30.162 1.1875	-2.5 -0.10	158.648 6.2460	6.350 0.2500	3.5 0.14	104.0 4.09	110.0 4.33	144.0 5.67	151.4	38.3	0.1416	2.56 5.63
28.971 1.1406	24.608 0.9688	3.0 0.12	154.681 6.0898	5.558 0.2188	3.0 0.12	103.0 4.06	108.0 4.25	152.0 5.98	129.7	37.2	0.1386	1.94 4.28

<sup>(4)</sup>Negative value indicates effective center inside cone (inner-ring) backface.

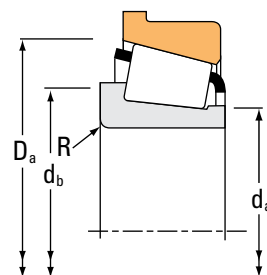
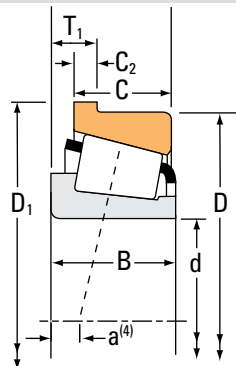
<sup>(5)</sup>These maximum fillet radii will be cleared by the bearing corners.

Continued on next page.

# TAPERED ROLLER BEARINGS

## SINGLE-ROW • TYPE TSF

### TYPE TSF



Bearing Dimensions			Load Ratings							Part Number	
Bore d	O.D. D	Width T <sub>1</sub>	Dynamic <sup>(1)</sup>			Dynamic <sup>(3)</sup>			Static C <sub>0</sub>	Inner	Outer
			C <sub>1</sub>	e	Y	C <sub>90</sub>	C <sub>a90</sub>	K			
mm in.	mm in.	mm in.	N lbf			N lbf	N lbf		N lbf		
95.250 3.7500	142.875 5.6250	15.080 0.5937	197000 44300	0.45	1.34	51100 11500	39200 8810	1.30	307000 69000	47896	47825-B
96.838 3.8125	149.225 5.8750	12.700 0.5000	193000 43400	0.49	1.22	50100 11300	42200 9480	1.19	241000 54300	42381	42587-B
98.425 3.8750	212.725 8.3750	23.812 0.9375	680000 153000	0.33	1.84	176000 39600	98300 22100	1.79	906000 204000	HH224332	HH224310-B
98.425 3.8750	190.500 7.5000	22.225 0.8750	534000 120000	0.33	1.79	138000 31100	79300 17800	1.74	692000 156000	HH221442	HH221410-B
98.425 3.8750	180.975 7.1250	17.462 0.6875	346000 77800	0.39	1.56	89700 20200	59200 13300	1.51	495000 111000	779	772-B
98.425 3.8750	168.275 6.6250	18.255 0.7187	265000 59500	0.47	1.28	68600 15400	55300 12400	1.24	386000 86700	685	672-B
98.425 3.8750	161.925 6.3750	16.667 0.6562	223000 50200	0.47	1.26	57900 13000	47100 10600	1.23	343000 77000	52387	52637-B
99.982 3.9363	190.500 7.5000	22.225 0.8750	534000 120000	0.33	1.79	138000 31100	79300 17800	1.74	692000 156000	HH221447	HH221410-B
100.000 3.9370	180.975 7.1250	17.462 0.6875	346000 77800	0.39	1.56	89700 20200	59200 13300	1.51	495000 111000	783	772-B
100.000 3.9370	145.000 5.7087	10.500 0.4134	125000 28200	0.47	1.27	32500 7310	26300 5920	1.24	172000 38700	JP10049	JP10010-B
101.600 4.0000	212.725 8.3750	23.812 0.9375	572000 129000	0.33	1.84	148000 33300	82700 18600	1.79	786000 177000	941	932-B
101.600 4.0000	200.000 7.8740	27.361 1.0772	482000 108000	0.63	0.95	125000 28100	135000 30400	0.92	519000 117000	98400	98788-B
101.600 4.0000	190.500 7.5000	22.225 0.8750	458000 103000	0.33	1.79	119000 26700	68000 15300	1.74	630000 142000	861	854-B
101.600 4.0000	190.500 7.5000	22.225 0.8750	534000 120000	0.33	1.79	138000 31100	79300 17800	1.74	692000 156000	HH221449	HH221410-B
101.600 4.0000	180.975 7.1250	17.462 0.6875	346000 77800	0.39	1.56	89700 20200	59200 13300	1.51	495000 111000	780	772-B
101.600 4.0000	168.275 6.6250	18.255 0.7187	265000 59500	0.47	1.28	68600 15400	55300 12400	1.24	386000 86700	687	672-B
101.600 4.0000	161.925 6.3750	16.667 0.6562	223000 50200	0.47	1.26	57900 13000	47100 10600	1.23	343000 77000	52400	52637-B

<sup>(1)</sup>Based on  $1 \times 10^6$  revolutions  $L_{10}$  life, for the ISO life-calculation method.

<sup>(2)</sup>Consult your Timken engineer for instructions on use or review the Timken Engineering Manual on [timken.com/catalogs](http://timken.com/catalogs).

<sup>(3)</sup>Based on  $90 \times 10^6$  revolutions  $L_{10}$  life, for The Timken Company life-calculation method.  $C_{90}$  and  $C_{a90}$  are radial and thrust values.



Bearing Dimensions									Geometry Factors			Bearing Weight
Width B	Width C	Eff. Ctr. a <sup>(4)</sup>	Outer Ring Flange O.D. D <sub>1</sub>	Flange Width C <sub>2</sub>	Shaft			Housing	G <sub>1</sub>	G <sub>2</sub>	C <sub>g</sub>	
					Max Shaft Fillet Radius R <sup>(5)</sup>	Backing Shoulder Dia. d <sub>a</sub>	Backing Shoulder Dia. d <sub>b</sub>	Backing Shoulder Dia. D <sub>a</sub>				
mm in.	mm in.	mm in.	mm in.	mm in.	mm in.	mm in.	mm in.	mm in.				kg lbs.
34.925 1.3750	26.195 1.0313	-1.0 -0.04	149.123 5.8710	7.938 0.3125	3.5 0.14	103.0 4.06	110.0 4.33	142.0 5.59	153.2	38.1	0.1428	1.89 4.14
28.971 1.1406	24.608 0.9688	3.0 0.12	154.681 6.0898	5.558 0.2188	3.5 0.14	105.0 4.13	112.0 4.41	152.0 5.98	129.7	37.2	0.1386	1.88 4.15
66.675 2.6250	53.975 2.1250	-18.8 -0.74	223.733 8.8084	11.112 0.4375	3.5 0.14	119.0 4.69	123.0 4.84	204.0 8.03	366.6	47.9	0.1182	12.45 27.43
57.531 2.2650	46.038 1.8125	-15.0 -0.59	199.923 7.8710	11.112 0.4375	3.5 0.14	113.0 4.45	119.0 4.69	179.0 7.05	265.6	28.4	0.1072	7.47 16.46
48.006 1.8900	38.100 1.5000	-8.1 -0.32	188.798 7.4330	7.938 0.3125	3.5 0.14	110.0 4.33	116.0 4.57	168.0 6.61	227.3	41.3	0.1067	5.37 11.83
41.275 1.6250	30.162 1.1875	-2.8 -0.11	175.336 6.9030	7.142 0.2812	3.5 0.14	109.0 4.29	116.0 4.57	160.0 6.30	182.5	37.3	0.1056	3.64 8.02
36.116 1.4219	26.195 1.0313	-0.5 -0.02	168.173 6.6210	6.350 0.2500	3.5 0.14	108.0 4.25	114.0 4.49	155.0 6.10	175.4	41.7	0.1519	2.85 6.28
57.531 2.2650	46.038 1.8125	-15.0 -0.59	199.923 7.8710	11.112 0.4375	6.4 0.25	114.0 4.49	126.0 4.96	179.0 7.05	265.6	28.4	0.1072	7.33 16.14
48.006 1.8900	38.100 1.5000	-8.1 -0.32	188.798 7.4330	7.938 0.3125	3.5 0.14	111.0 4.37	118.0 4.65	168.0 6.61	227.3	41.3	0.1067	5.28 11.63
22.500 0.8858	17.500 0.6890	6.1 0.24	152.000 5.9843	4.000 0.1575	3.0 0.12	106.0 4.17	112.0 4.41	142.0 5.59	104.0	40.9	0.1264	1.19 2.61
66.675 2.6250	53.975 2.1250	-19.8 -0.78	223.736 8.8085	11.112 0.4375	7.0 0.28	117.0 4.61	130.0 5.12	199.0 7.83	338.6	39.8	0.1153	11.33 24.96
49.212 1.9375	34.925 1.3750	1.3 0.05	209.550 8.2500	9.525 0.3750	3.5 0.14	120.6 4.75	128.0 5.04	188.0 7.40	203.4	37.5	0.1197	6.98 15.40
57.531 2.2650	44.450 1.7500	-15.2 -0.60	199.923 7.8710	9.525 0.3750	8.0 0.31	114.0 4.49	129.0 5.08	174.0 6.85	264.1	44.9	0.1072	7.06 15.58
57.531 2.2650	46.038 1.8125	-15.0 -0.59	199.923 7.8710	11.112 0.4375	8.0 0.31	115.9 4.56	131.0 5.16	179.0 7.05	265.6	28.4	0.1072	7.22 15.91
48.006 1.8900	38.100 1.5000	-8.1 -0.32	188.798 7.4330	7.938 0.3125	3.5 0.14	113.0 4.45	119.0 4.69	168.0 6.61	227.3	41.3	0.1067	5.18 11.42
41.275 1.6250	30.162 1.1875	-2.8 -0.11	175.336 6.9030	7.142 0.2812	3.5 0.14	112.0 4.41	118.0 4.65	160.0 6.30	182.5	37.3	0.1056	3.47 7.66
36.116 1.4219	26.195 1.0313	-0.5 -0.02	168.173 6.6210	6.350 0.2500	3.5 0.14	111.0 4.37	117.0 4.61	155.0 6.10	175.4	41.7	0.1519	2.72 5.99

<sup>(4)</sup>Negative value indicates effective center inside cone (inner-ring) backface.

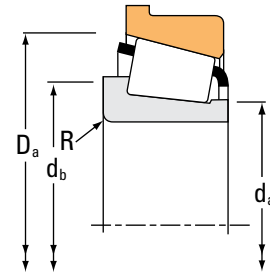
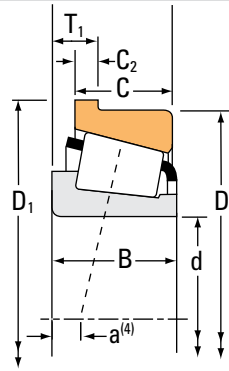
<sup>(5)</sup>These maximum fillet radii will be cleared by the bearing corners.

Continued on next page.

# TAPERED ROLLER BEARINGS

## SINGLE-ROW • TYPE TSF

### TYPE TSF



Bearing Dimensions			Load Ratings							Part Number	
Bore d	O.D. D	Width T <sub>1</sub>	Dynamic <sup>(1)</sup>			Dynamic <sup>(3)</sup>			Static C <sub>0</sub>	Inner	Outer
			C <sub>1</sub>	e	Y	C <sub>90</sub>	C <sub>a90</sub>	K			
mm in.	mm in.	mm in.	N lbf			N lbf	N lbf		N lbf		
101.600 4.0000	160.000 6.2992	16.667 0.6562	223000 50200	0.47	1.26	57900 13000	47100 10600	1.23	343000 77000	52400	52630XB
101.600 4.0000	157.162 6.1875	16.667 0.6562	223000 50200	0.47	1.26	57900 13000	47100 10600	1.23	343000 77000	52400	52618-B
104.775 4.1250	190.500 7.5000	20.638 0.8125	364000 81700	0.42	1.44	94300 21200	67100 15100	1.40	543000 122000	71412	71750-B
104.775 4.1250	180.975 7.1250	17.462 0.6875	346000 77800	0.39	1.56	89700 20200	59200 13300	1.51	495000 111000	782	772-B
107.950 4.2500	212.725 8.3750	23.812 0.9375	572000 129000	0.33	1.84	148000 33300	82700 18600	1.79	786000 177000	936	932-B
107.950 4.2500	212.725 8.3750	23.812 0.9375	680000 153000	0.33	1.84	176000 39600	98300 22100	1.79	906000 204000	HH224340	HH224310-B
107.950 4.2500	190.500 7.5000	20.638 0.8125	364000 81700	0.42	1.44	94300 21200	67100 15100	1.40	543000 122000	71425	71750-B
107.950 4.2500	165.100 6.5000	15.875 0.6250	226000 50900	0.50	1.21	58700 13200	50000 11200	1.18	355000 79700	56425	56650-B
109.538 4.3125	158.750 6.2500	11.908 0.4688	115000 25900	0.61	0.99	29900 6710	31000 6960	0.96	179000 40100	37431	37625-B
109.992 4.3304	177.800 7.0000	18.258 0.7188	275000 61800	0.52	1.16	71200 16000	62900 14100	1.13	419000 94200	64433	64700-B
111.125 4.3750	190.500 7.5000	20.638 0.8125	364000 81700	0.42	1.44	94300 21200	67100 15100	1.40	543000 122000	71437	71750-B
114.300 4.5000	212.725 8.3750	23.812 0.9375	572000 129000	0.33	1.84	148000 33300	82700 18600	1.79	786000 177000	938	932-B
114.300 4.5000	190.500 7.5000	20.638 0.8125	364000 81700	0.42	1.44	94300 21200	67100 15100	1.40	543000 122000	71450	71750-B
114.300 4.5000	177.800 7.0000	18.258 0.7188	275000 61800	0.52	1.16	71200 16000	62900 14100	1.13	419000 94200	64450	64700-B
115.000 4.5276	165.000 6.4961	12.500 0.4921	160000 35900	0.46	1.31	41400 9310	32500 7310	1.27	245000 55100	JLM722948	JLM722912-B
117.475 4.6250	180.975 7.1250	16.667 0.6562	232000 52100	0.50	1.21	60100 13500	51100 11500	1.18	271000 61000	68462	68712-B
120.000 4.7244	180.000 7.0866	16.350 0.6437	247000 55500	0.41	1.45	64000 14400	45300 10200	1.41	377000 84700	JM624649	JM624610-B

<sup>(1)</sup>Based on 1 x 10<sup>6</sup> revolutions L<sub>10</sub> life, for the ISO life-calculation method.

<sup>(2)</sup>Consult your Timken engineer for instructions on use or review the Timken Engineering Manual on timken.com/catalogs.

<sup>(3)</sup>Based on 90 x 10<sup>6</sup> revolutions L<sub>10</sub> life, for The Timken Company life-calculation method. C<sub>90</sub> and C<sub>a90</sub> are radial and thrust values.

Bearing Dimensions									Geometry Factors			Bearing Weight
Width B	Width C	Eff. Ctr. a <sup>(4)</sup>	Outer Ring Flange O.D. D <sub>1</sub>	Flange Width C <sub>2</sub>	Shaft			Housing	G <sub>1</sub>	G <sub>2</sub>	C <sub>g</sub>	
					Max Shaft Fillet Radius R <sup>(5)</sup>	Backing Shoulder Dia.		Backing Shoulder Dia. D <sub>a</sub>				
mm in.	mm in.	mm in.	mm in.	mm in.	mm in.	mm in.	mm in.	mm in.				kg lbs.
<b>36.116</b> 1.4219	<b>26.195</b> 1.0313	<b>-0.5</b> -0.02	<b>166.345</b> 6.5490	<b>6.350</b> 0.2500	<b>3.5</b> 0.14	<b>111.0</b> 4.37	<b>117.0</b> 4.61	<b>155.0</b> 6.10	175.4	41.7	0.1519	<b>2.64</b> 5.81
<b>36.116</b> 1.4219	<b>26.195</b> 1.0313	<b>-0.5</b> -0.02	<b>163.512</b> 6.4375	<b>6.350</b> 0.2500	<b>3.5</b> 0.14	<b>111.0</b> 4.37	<b>117.0</b> 4.61	<b>155.0</b> 6.10	175.4	41.7	0.1519	<b>2.47</b> 5.44
<b>49.212</b> 1.9375	<b>34.925</b> 1.3750	<b>-6.6</b> -0.26	<b>198.323</b> 7.8080	<b>7.938</b> 0.3125	<b>3.5</b> 0.14	<b>118.0</b> 4.65	<b>124.0</b> 4.88	<b>181.0</b> 7.13	269.2	49.5	0.1156	<b>5.94</b> 13.10
<b>48.006</b> 1.8900	<b>38.100</b> 1.5000	<b>-8.1</b> -0.32	<b>188.798</b> 7.4330	<b>7.938</b> 0.3125	<b>3.5</b> 0.14	<b>116.0</b> 4.57	<b>122.0</b> 4.80	<b>168.0</b> 6.61	227.3	41.3	0.1067	<b>4.99</b> 10.99
<b>66.675</b> 2.6250	<b>53.975</b> 2.1250	<b>-19.8</b> -0.78	<b>223.736</b> 8.8085	<b>11.112</b> 0.4375	<b>8.0</b> 0.31	<b>122.0</b> 4.80	<b>137.0</b> 5.39	<b>199.0</b> 7.83	338.6	39.8	0.1153	<b>10.77</b> 23.72
<b>66.675</b> 2.6250	<b>53.975</b> 2.1250	<b>-18.8</b> -0.74	<b>223.733</b> 8.8084	<b>11.112</b> 0.4375	<b>8.0</b> 0.31	<b>126.0</b> 4.96	<b>139.0</b> 5.47	<b>204.0</b> 8.03	366.6	47.9	0.1182	<b>11.57</b> 25.50
<b>49.212</b> 1.9375	<b>34.925</b> 1.3750	<b>-6.6</b> -0.26	<b>198.323</b> 7.8080	<b>7.938</b> 0.3125	<b>3.6</b> 0.14	<b>120.0</b> 4.72	<b>126.0</b> 4.96	<b>181.0</b> 7.13	269.2	49.5	0.1156	<b>5.74</b> 12.67
<b>36.512</b> 1.4375	<b>26.988</b> 1.0625	<b>2.0</b> 0.08	<b>171.348</b> 6.7460	<b>6.350</b> 0.2500	<b>3.5</b> 0.14	<b>117.0</b> 4.61	<b>123.0</b> 4.84	<b>162.0</b> 6.38	190.9	47.7	0.1584	<b>2.74</b> 6.03
<b>21.438</b> 0.8440	<b>15.875</b> 0.6250	<b>13.7</b> 0.54	<b>163.413</b> 6.4336	<b>4.762</b> 0.1875	<b>3.5</b> 0.14	<b>116.0</b> 4.57	<b>123.0</b> 4.84	<b>153.0</b> 6.02	123.7	57.1	0.1443	<b>1.39</b> 3.07
<b>41.275</b> 1.6250	<b>30.162</b> 1.1875	<b>1.3</b> 0.05	<b>184.841</b> 7.2772	<b>7.145</b> 0.2813	<b>3.5</b> 0.14	<b>121.0</b> 4.76	<b>128.0</b> 5.04	<b>174.0</b> 6.85	218.8	45.3	0.1153	<b>3.92</b> 8.65
<b>49.212</b> 1.9375	<b>34.925</b> 1.3750	<b>-6.6</b> -0.26	<b>198.323</b> 7.8080	<b>7.938</b> 0.3125	<b>3.6</b> 0.14	<b>123.0</b> 4.84	<b>129.0</b> 5.08	<b>181.0</b> 7.13	269.2	49.5	0.1156	<b>5.53</b> 12.20
<b>66.675</b> 2.6250	<b>53.975</b> 2.1250	<b>-19.8</b> -0.78	<b>223.736</b> 8.8085	<b>11.112</b> 0.4375	<b>7.0</b> 0.28	<b>128.0</b> 5.04	<b>141.0</b> 5.55	<b>199.0</b> 7.83	338.6	39.8	0.1153	<b>10.20</b> 22.47
<b>49.212</b> 1.9375	<b>34.925</b> 1.3750	<b>-6.6</b> -0.26	<b>198.323</b> 7.8080	<b>7.938</b> 0.3125	<b>3.6</b> 0.14	<b>125.0</b> 4.92	<b>132.0</b> 5.20	<b>181.0</b> 7.13	269.2	49.5	0.1156	<b>5.32</b> 11.73
<b>41.275</b> 1.6250	<b>30.162</b> 1.1875	<b>1.3</b> 0.05	<b>184.841</b> 7.2772	<b>7.145</b> 0.2813	<b>3.5</b> 0.14	<b>125.0</b> 4.92	<b>131.0</b> 5.16	<b>174.0</b> 6.85	218.8	45.3	0.1153	<b>3.67</b> 8.11
<b>27.000</b> 1.0630	<b>21.000</b> 0.8268	<b>5.6</b> 0.22	<b>172.000</b> 6.7717	<b>5.500</b> 0.2165	<b>3.3</b> 0.13	<b>121.0</b> 4.76	<b>127.0</b> 5.00	<b>160.0</b> 6.30	161.0	57.2	0.1449	<b>1.83</b> 4.03
<b>31.750</b> 1.2500	<b>25.400</b> 1.0000	<b>5.3</b> 0.21	<b>188.016</b> 7.4022	<b>7.145</b> 0.2813	<b>3.5</b> 0.14	<b>125.0</b> 4.92	<b>132.0</b> 5.20	<b>172.0</b> 6.77	163.1	51.7	0.1026	<b>2.87</b> 6.33
<b>36.000</b> 1.4173	<b>26.000</b> 1.0236	<b>0.0</b> 0.00	<b>188.000</b> 7.4016	<b>6.580</b> 0.2590	<b>3.5</b> 0.14	<b>128.0</b> 5.04	<b>135.0</b> 5.31	<b>175.0</b> 6.89	226.8	61.6	0.1084	<b>3.04</b> 6.70

<sup>(4)</sup>Negative value indicates effective center inside cone (inner-ring) backface.

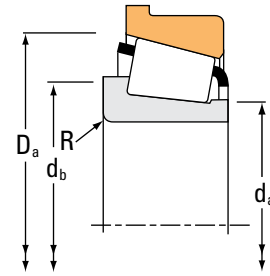
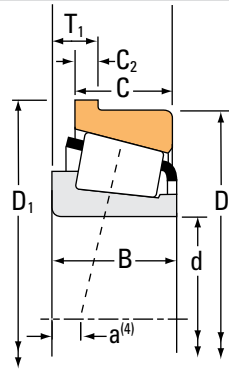
<sup>(5)</sup>These maximum fillet radii will be cleared by the bearing corners.

Continued on next page.

# TAPERED ROLLER BEARINGS

## SINGLE-ROW • TYPE TSF

### TYPE TSF



Bearing Dimensions			Load Ratings							Part Number		
Bore d	O.D. D	Width T <sub>1</sub>	Dynamic <sup>(1)</sup>		Factors <sup>(2)</sup>		Dynamic <sup>(3)</sup>		Factors <sup>(2)</sup>	Static C <sub>0</sub>	Inner	Outer
			C <sub>1</sub>	e	Y	C <sub>90</sub>	C <sub>a90</sub>	K	C <sub>0</sub>			
mm in.	mm in.	mm in.	N lbf			N lbf	N lbf		N lbf			
120.650 4.7500	234.950 9.2500	25.400 1.0000	629000 141000	0.37	1.62	163000 36700	103000 23200	1.58	931000 209000		95475	95925-B
120.650 4.7500	160.338 6.3125	8.733 0.3438	97500 21900	0.43	1.38	25300 5680	18800 4230	1.34	206000 46400		L624549	L624510-B
123.825 4.8750	182.562 7.1875	12.700 0.5000	268000 60200	0.31	1.97	69400 15600	36300 8160	1.91	493000 111000		48286	48220-B
127.000 5.0000	234.950 9.2500	25.400 1.0000	629000 141000	0.37	1.62	163000 36700	103000 23200	1.58	931000 209000		95500	95925-B
127.000 5.0000	215.900 8.5000	20.638 0.8125	382000 85900	0.49	1.23	99000 22300	82600 18600	1.20	614000 138000		74500	74850-B
127.000 5.0000	182.562 7.1875	12.700 0.5000	268000 60200	0.31	1.97	69400 15600	36300 8160	1.91	493000 111000		48290	48220-B
130.000 5.1181	185.000 7.2835	13.000 0.5118	196000 44000	0.47	1.27	50800 11400	41100 9250	1.24	283000 63600		JP13049	JP13010-B
130.175 5.1250	196.850 7.7500	15.083 0.5938	368000 82600	0.34	1.74	95300 21400	56100 12600	1.70	625000 141000		67389	67322-B
133.350 5.2500	234.950 9.2500	25.400 1.0000	629000 141000	0.37	1.62	163000 36700	103000 23200	1.58	931000 209000		95525	95925-B
133.350 5.2500	215.900 8.5000	20.638 0.8125	382000 85900	0.49	1.23	99000 22300	82600 18600	1.20	614000 138000		74525	74850-B
133.350 5.2500	190.500 7.5000	11.908 0.4688	283000 63600	0.32	1.87	73300 16500	40300 9060	1.82	542000 122000		48385	48320-B
136.525 5.3750	254.000 10.0000	30.162 1.1875	660000 148000	0.41	1.47	171000 38500	119000 26800	1.43	1030000 231000		99537	99100-B
136.525 5.3750	215.900 8.5000	20.638 0.8125	382000 85900	0.49	1.23	99000 22300	82600 18600	1.20	614000 138000		74537	74850-B
139.700 5.5000	254.000 10.0000	30.162 1.1875	660000 148000	0.41	1.47	171000 38500	119000 26800	1.43	1030000 231000		99550	99100-B
139.700 5.5000	241.300 9.5000	22.225 0.8750	597000 134000	0.32	1.88	155000 34800	84500 19000	1.83	932000 210000		HM231132	HM231115-B
139.700 5.5000	215.900 8.5000	20.638 0.8125	382000 85900	0.49	1.23	99000 22300	82600 18600	1.20	614000 138000		74550	74850-B
140.000 5.5118	195.000 7.6772	13.000 0.5118	203000 45700	0.50	1.19	52700 11800	45400 10200	1.16	304000 68400		JP14049	JP14010-B

<sup>(1)</sup>Based on  $1 \times 10^6$  revolutions  $L_{10}$  life, for the ISO life-calculation method.

<sup>(2)</sup>Consult your Timken engineer for instructions on use or review the Timken Engineering Manual on [timken.com/catalogs](http://timken.com/catalogs).

<sup>(3)</sup>Based on  $90 \times 10^6$  revolutions  $L_{10}$  life, for The Timken Company life-calculation method.  $C_{90}$  and  $C_{a90}$  are radial and thrust values.

Bearing Dimensions									Geometry Factors			Bearing Weight
Width B	Width C	Eff. Ctr. a <sup>(4)</sup>	Outer Ring Flange O.D. D <sub>1</sub>	Flange Width C <sub>2</sub>	Shaft			Housing	G <sub>1</sub>	G <sub>2</sub>	C <sub>g</sub>	
					Max Shaft Fillet Radius R <sup>(5)</sup>	Backing Shoulder Dia.		Backing Shoulder Dia. D <sub>a</sub>				
mm in.	mm in.	mm in.	mm in.	mm in.	mm in.	mm in.	mm in.	mm in.				kg lbs.
63.500 2.5000	49.212 1.9375	-14.0 -0.55	245.958 9.6834	11.112 0.4375	6.4 0.25	137.0 5.39	149.0 5.87	217.0 8.54	453.9	59.4	0.1323	12.91 28.47
21.433 0.8438	16.670 0.6563	8.4 0.33	164.203 6.4647	3.970 0.1563	1.5 0.06	127.0 5.00	129.0 5.08	157.0 6.18	195.2	139.1	0.1509	1.20 2.63
38.100 1.5000	33.338 1.3125	-5.6 -0.22	188.811 7.4335	6.350 0.2500	3.5 0.14	133.0 5.24	139.0 5.47	177.0 6.97	353.0	91.4	0.1138	3.61 7.96
63.500 2.5000	49.212 1.9375	-14.0 -0.55	245.958 9.6834	11.112 0.4375	6.4 0.25	142.0 5.59	154.0 6.06	217.0 8.54	453.9	59.4	0.1323	12.30 27.12
47.625 1.8750	34.925 1.3750	2.3 0.09	223.733 8.8084	7.938 0.3125	3.5 0.14	141.0 5.55	148.0 5.83	209.0 8.23	362.9	68.5	0.1338	7.12 15.71
38.100 1.5000	33.338 1.3125	-5.6 -0.22	188.811 7.4335	6.350 0.2500	3.5 0.14	135.0 5.31	141.0 5.55	177.0 6.97	353.0	91.4	0.1138	3.43 7.55
27.000 1.0630	21.000 0.8268	8.9 0.35	192.000 7.5591	5.000 0.1969	3.0 0.12	137.0 5.39	143.0 5.63	188.0 7.40	192.2	60.3	0.1064	2.24 4.95
46.038 1.8125	38.100 1.5000	-6.4 -0.25	203.891 8.0272	7.145 0.2813	3.5 0.14	141.0 5.55	147.0 5.79	191.0 7.52	383.7	70.1	0.1220	5.06 11.15
63.500 2.5000	49.212 1.9375	-14.0 -0.55	245.958 9.6834	11.112 0.4375	9.7 0.38	148.0 5.83	166.0 6.54	217.0 8.54	453.9	59.4	0.1323	11.56 25.49
47.625 1.8750	34.925 1.3750	2.3 0.09	223.733 8.8084	7.938 0.3125	3.5 0.14	146.0 5.75	152.0 5.98	209.0 8.23	362.9	68.5	0.1338	6.64 14.64
39.688 1.5625	33.338 1.3125	-4.1 -0.16	195.956 7.7148	5.558 0.2188	3.5 0.14	142.0 5.59	148.0 5.83	186.0 7.32	403.8	105.1	0.1209	3.61 7.94
66.675 2.6250	47.625 1.8750	-12.2 -0.48	264.973 10.4320	11.112 0.4375	7.0 0.28	156.0 6.14	167.0 6.57	238.0 9.37	555.5	73.5	0.1459	14.79 32.61
47.625 1.8750	34.925 1.3750	2.3 0.09	223.733 8.8084	7.938 0.3125	3.5 0.14	148.0 5.83	155.0 6.10	209.0 8.23	362.9	68.5	0.1338	6.39 14.09
66.675 2.6250	47.625 1.8750	-12.2 -0.48	264.973 10.4320	11.112 0.4375	7.0 0.28	156.0 6.14	170.0 6.69	238.0 9.37	555.5	73.5	0.1459	14.40 31.76
56.642 2.2300	44.450 1.7500	-11.4 -0.45	250.723 9.8710	9.525 0.3750	3.5 0.14	156.0 6.14	160.0 6.30	224.0 8.82	532.8	85.9	0.1327	10.73 23.65
47.625 1.8750	34.925 1.3750	2.3 0.09	223.733 8.8084	7.938 0.3125	3.5 0.14	151.0 5.94	158.0 6.22	209.0 8.23	362.9	68.5	0.1338	6.13 13.52
27.000 1.0630	21.000 0.8268	11.9 0.47	202.000 7.9528	5.000 0.1969	3.0 0.12	148.0 5.83	153.0 6.02	198.0 7.80	219.5	68.2	0.1133	2.40 5.30

<sup>(4)</sup>Negative value indicates effective center inside cone (inner-ring) backface.

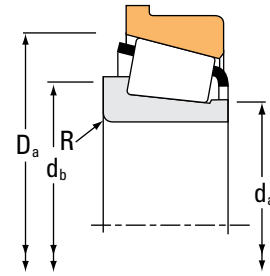
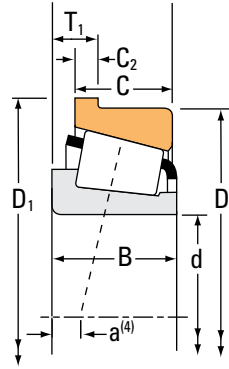
<sup>(5)</sup>These maximum fillet radii will be cleared by the bearing corners.

Continued on next page.

# TAPERED ROLLER BEARINGS

## SINGLE-ROW • TYPE TSF

### TYPE TSF



Bearing Dimensions			Load Ratings							Part Number			
Bore d	O.D. D	Width T <sub>1</sub>	Dynamic <sup>(1)</sup>		Factors <sup>(2)</sup>		Dynamic <sup>(3)</sup>		Factors <sup>(2)</sup>		Static C <sub>0</sub>	Inner	Outer
			C <sub>1</sub>	e	Y	C <sub>90</sub>	C <sub>a90</sub>	K	N	N			
mm in.	mm in.	mm in.	N lbf			N lbf	N lbf		N lbf				
142.875 5.6250	241.300 9.5000	22.225 0.8750	597000 134000	0.32	1.88	155000 34800	84500 19000	1.83	932000 210000		HM231136	HM231115-B	
142.875 5.6250	200.025 7.8750	12.700 0.5000	286000 64400	0.34	1.78	74300 16700	42800 9610	1.74	560000 126000		48685	48620-B	
142.875 5.6250	193.675 7.6250	9.525 0.3750	196000 44200	0.37	1.63	50900 11400	32100 7220	1.59	394000 88600		36686	36620-B	
146.050 5.7500	254.000 10.0000	30.162 1.1875	660000 148000	0.41	1.47	171000 38500	119000 26800	1.43	1030000 231000		99575	99100-B	
146.050 5.7500	241.300 9.5000	22.225 0.8750	515000 116000	0.44	1.36	134000 30000	101000 22700	1.32	810000 182000		82576	82950-B	
146.050 5.7500	241.300 9.5000	22.225 0.8750	597000 134000	0.32	1.88	155000 34800	84500 19000	1.83	932000 210000		HM231140	HM231115-B	
146.050 5.7500	193.675 7.6250	9.525 0.3750	196000 44200	0.37	1.63	50900 11400	32100 7220	1.59	394000 88600		36690	36620-B	
149.225 5.8750	254.000 10.0000	30.162 1.1875	660000 148000	0.41	1.47	171000 38500	119000 26800	1.43	1030000 231000		99587	99100-B	
149.225 5.8750	241.300 9.5000	22.225 0.8750	597000 134000	0.32	1.88	155000 34800	84500 19000	1.83	932000 210000		HM231149	HM231115-B	
150.000 5.9055	205.000 8.0709	12.000 0.4724	194000 43500	0.46	1.31	50200 11300	39400 8860	1.27	339000 76100		JL730646	JL730612-B	
152.400 6.0000	254.000 10.0000	30.162 1.1875	660000 148000	0.41	1.47	171000 38500	119000 26800	1.43	1030000 231000		99600	99100-B	
152.400 6.0000	192.088 7.5625	9.970 0.3925	143000 32000	0.42	1.44	37000 8310	26300 5920	1.40	277000 62200		L630349	L630310-B	
158.750 6.2500	225.425 8.8750	13.495 0.5313	303000 68200	0.38	1.57	78600 17700	51600 11600	1.52	635000 143000		46780	46720-B	
160.325 6.3120	288.925 11.3750	26.988 1.0625	976000 219000	0.32	1.88	253000 56900	138000 31100	1.83	1240000 278000		HM237532	HM237510-B	
165.100 6.5000	254.000 10.0000	22.225 0.8750	498000 112000	0.37	1.62	129000 29000	81600 18300	1.58	644000 145000		86650	86100-B	
165.100 6.5000	247.650 9.7500	16.670 0.6563	405000 91100	0.44	1.36	105000 23600	79000 17800	1.33	779000 175000		67780	67720-B	
165.100 6.5000	225.425 8.8750	13.495 0.5313	303000 68200	0.38	1.57	78600 17700	51600 11600	1.52	635000 143000		46790	46720-B	

<sup>(1)</sup>Based on 1 x 10<sup>6</sup> revolutions L<sub>10</sub> life, for the ISO life-calculation method.

<sup>(2)</sup>Consult your Timken engineer for instructions on use or review the Timken Engineering Manual on timken.com/catalogs.

<sup>(3)</sup>Based on 90 x 10<sup>6</sup> revolutions L<sub>10</sub> life, for The Timken Company life-calculation method. C<sub>90</sub> and C<sub>a90</sub> are radial and thrust values.

Bearing Dimensions									Geometry Factors			Bearing Weight
Width B	Width C	Eff. Ctr. a <sup>(4)</sup>	Outer Ring Flange O.D. D <sub>1</sub>	Flange Width C <sub>2</sub>	Shaft			Housing	G <sub>1</sub>	G <sub>2</sub>	C <sub>g</sub>	
					Max Shaft Fillet Radius R <sup>(5)</sup>	Backing Shoulder Dia.		Backing Shoulder Dia. D <sub>a</sub>				
mm in.	mm in.	mm in.	mm in.	mm in.	mm in.	mm in.	mm in.	mm in.				kg lbs.
56.642 2.2300	44.450 1.7500	-11.4 -0.45	250.723 9.8710	9.525 0.3750	3.5 0.14	158.0 6.22	162.0 6.38	224.0 8.82	532.8	85.9	0.1327	10.42 22.96
39.688 1.5625	34.130 1.3437	-3.0 -0.12	205.481 8.0898	5.555 0.2187	3.5 0.14	151.0 5.94	158.0 6.22	194.0 7.64	439.6	130.5	0.1261	3.87 8.54
28.575 1.1250	23.020 0.9063	4.8 0.19	197.541 7.7772	3.970 0.1563	1.5 0.06	151.0 5.94	153.0 6.02	190.0 7.48	366.1	152.5	0.1768	2.46 5.42
66.675 2.6250	47.625 1.8750	-12.2 -0.48	264.973 10.4320	11.112 0.4375	7.0 0.28	162.0 6.38	175.0 6.89	238.0 9.37	555.5	73.5	0.1459	13.66 30.11
56.642 2.2300	44.450 1.7500	-3.6 -0.14	250.723 9.8710	9.525 0.3750	3.5 0.14	160.0 6.30	166.0 6.54	226.0 8.90	460.5	81.1	0.1405	10.33 22.77
56.642 2.2300	44.450 1.7500	-11.4 -0.45	250.723 9.8710	9.525 0.3750	3.5 0.14	160.0 6.30	164.0 6.46	224.0 8.82	532.8	85.9	0.1327	10.10 22.26
28.575 1.1250	23.020 0.9063	4.8 0.19	197.541 7.7772	3.970 0.1563	1.5 0.06	153.0 6.02	155.0 6.10	190.0 7.48	366.1	152.5	0.1768	2.30 5.07
66.675 2.6250	47.625 1.8750	-12.2 -0.48	264.973 10.4320	11.112 0.4375	7.0 0.28	170.0 6.69	181.0 7.13	238.0 9.37	555.5	73.5	0.1459	13.32 29.37
56.642 2.2300	44.450 1.7500	-11.4 -0.45	250.723 9.8710	9.525 0.3750	3.5 0.14	163.0 6.42	167.0 6.57	224.0 8.82	532.8	85.9	0.1327	9.77 21.54
28.575 1.1250	21.438 0.8440	11.4 0.45	210.000 8.2677	4.862 0.1914	3.3 0.13	158.0 6.22	164.0 6.46	200.0 7.87	295.2	103.6	0.1763	2.67 5.90
66.675 2.6250	47.625 1.8750	-12.2 -0.48	264.973 10.4320	11.112 0.4375	7.0 0.28	169.7 6.68	181.0 7.13	238.0 9.37	555.5	73.5	0.1459	12.87 28.39
24.000 0.9449	19.000 0.7480	10.2 0.40	197.371 7.7705	3.967 0.1562	2.0 0.08	158.0 6.22	162.0 6.38	190.0 7.48	293.3	163.8	0.1698	1.63 3.59
39.688 1.5625	33.338 1.3125	2.5 0.10	230.881 9.0898	5.558 0.2188	3.5 0.14	169.0 6.65	176.0 6.93	219.0 8.62	572.0	174.7	0.1432	5.18 11.45
63.500 2.5000	47.625 1.8750	-11.7 -0.46	299.933 11.8084	11.112 0.4375	7.0 0.28	181.0 7.13	192.0 7.56	279.0 10.98	751.2	101.5	0.1168	17.94 39.56
46.038 1.8125	33.338 1.3125	-1.5 -0.06	263.525 10.3750	9.525 0.3750	4.8 0.19	176.0 6.93	185.0 7.28	239.0 9.41	466.3	111.9	0.1041	7.99 17.62
47.625 1.8750	38.100 1.5000	4.8 0.19	254.691 10.0272	7.145 0.2813	3.5 0.14	179.0 7.05	185.0 7.28	241.0 9.49	622.3	122.6	0.1214	8.47 18.68
39.688 1.5625	33.338 1.3125	2.5 0.10	230.881 9.0898	5.558 0.2188	3.5 0.14	174.0 6.85	181.0 7.13	219.0 8.62	572.0	174.7	0.1432	4.67 10.31

<sup>(4)</sup>Negative value indicates effective center inside cone (inner-ring) backface.

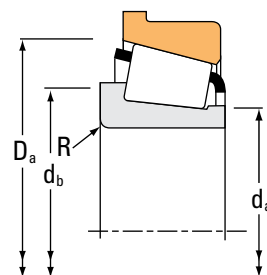
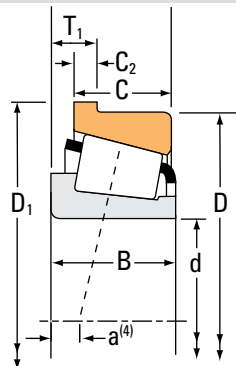
<sup>(5)</sup>These maximum fillet radii will be cleared by the bearing corners.

Continued on next page.

# TAPERED ROLLER BEARINGS

## SINGLE-ROW • TYPE TSF

### TYPE TSF



Bearing Dimensions			Load Ratings							Part Number			
Bore d	O.D. D	Width T <sub>1</sub>	Dynamic <sup>(1)</sup>		Factors <sup>(2)</sup>		Dynamic <sup>(3)</sup>		Factors <sup>(2)</sup>		Static C <sub>0</sub>	Inner	Outer
			C <sub>1</sub>	e	Y	C <sub>90</sub>	C <sub>a90</sub>	K	N	N			
mm in.	mm in.	mm in.	N lbf			N lbf	N lbf		N lbf				
171.450 6.7500	260.350 10.2500	25.400 1.0000	654000 147000	0.40	1.49	169000 38100	117000 26200	1.45	1180000 265000			HM535349	HM535310-B
174.625 6.8750	288.925 11.3750	26.988 1.0625	660000 148000	0.47	1.28	171000 38500	137000 30800	1.25	1070000 242000			94687	94113-B
174.625 6.8750	288.925 11.3750	26.988 1.0625	976000 219000	0.32	1.88	253000 56900	138000 31100	1.83	1240000 278000			HM237542	HM237510-B
177.800 7.0000	288.925 11.3750	26.988 1.0625	660000 148000	0.47	1.28	171000 38500	137000 30800	1.25	1070000 242000			94700	94113-B
177.800 7.0000	247.650 9.7500	16.670 0.6563	405000 91100	0.44	1.36	105000 23600	79000 17800	1.33	779000 175000			67790	67720-B
179.975 7.0856	317.500 12.5000	28.575 1.1250	731000 164000	0.52	1.15	190000 42600	170000 38200	1.12	1290000 290000			93708	93125-B
190.500 7.5000	317.500 12.5000	28.575 1.1250	731000 164000	0.52	1.15	190000 42600	170000 38200	1.12	1290000 290000			93750	93125-B
190.500 7.5000	266.700 10.5000	16.670 0.6563	416000 93600	0.48	1.26	108000 24300	88200 19800	1.22	835000 188000			67885	67820-B
193.675 7.6250	282.575 11.1250	23.812 0.9375	509000 114000	0.42	1.44	132000 29700	93900 21100	1.41	692000 156000			87762	87111-B
200.025 7.8750	317.500 12.5000	28.575 1.1250	731000 164000	0.52	1.15	190000 42600	170000 38200	1.12	1290000 290000			93787	93125-B
203.200 8.0000	317.500 12.5000	28.575 1.1250	731000 164000	0.52	1.15	190000 42600	170000 38200	1.12	1290000 290000			93800	93125-B
203.200 8.0000	282.575 11.1250	16.670 0.6563	503000 113000	0.51	1.18	130000 29300	114000 25500	1.15	876000 197000			67983	67920-B
206.375 8.1250	282.575 11.1250	16.670 0.6563	503000 113000	0.51	1.18	130000 29300	114000 25500	1.15	876000 197000			67985	67920-B
209.550 8.2500	317.500 12.5000	28.575 1.1250	731000 164000	0.52	1.15	190000 42600	170000 38200	1.12	1290000 290000			93825	93125-B
215.900 8.5000	406.400 16.0000	41.275 1.6250	1470000 331000	0.39	1.52	382000 85900	257000 57800	1.48	2250000 506000			EE820085	820160-B
215.900 8.5000	285.750 11.2500	19.050 0.7500	430000 96600	0.48	1.25	111000 25000	91800 20600	1.21	892000 200000			LM742749	LM742710-B
220.662 8.6875	314.325 12.3750	22.225 0.8750	695000 156000	0.33	1.80	180000 40500	103000 23100	1.76	1370000 308000			M244249	M244210-B

<sup>(1)</sup>Based on 1 x 10<sup>6</sup> revolutions L<sub>10</sub> life, for the ISO life-calculation method.

<sup>(2)</sup>Consult your Timken engineer for instructions on use or review the Timken Engineering Manual on timken.com/catalogs.

<sup>(3)</sup>Based on 90 x 10<sup>6</sup> revolutions L<sub>10</sub> life, for The Timken Company life-calculation method. C<sub>90</sub> and C<sub>a90</sub> are radial and thrust values.



Bearing Dimensions									Geometry Factors			Bearing Weight
Width B	Width C	Eff. Ctr. a <sup>(4)</sup>	Outer Ring Flange O.D. D <sub>1</sub>	Flange Width C <sub>2</sub>	Shaft			Housing	G <sub>1</sub>	G <sub>2</sub>	C <sub>g</sub>	
					Max Shaft Fillet Radius R <sup>(5)</sup>	Backing Shoulder Dia.		Backing Shoulder Dia. D <sub>a</sub>				
mm in.	mm in.	mm in.	mm in.	mm in.	mm in.	mm in.	mm in.	mm in.				kg lbs.
66.675 2.6250	52.388 2.0625	-8.6 -0.34	271.374 10.6840	11.112 0.4375	3.5 0.14	186.1 7.40	192.0 7.56	250.0 9.84	749.5	115.6	0.1263	12.73 28.06
63.500 2.5000	47.625 1.8750	-0.8 -0.03	299.933 11.8084	11.112 0.4375	7.0 0.28	193.0 7.60	204.0 8.03	272.0 10.71	692.3	93.9	0.1287	16.39 36.12
63.500 2.5000	47.625 1.8750	-11.7 -0.46	299.933 11.8084	11.112 0.4375	7.0 0.28	191.0 7.52	202.0 7.95	279.0 10.98	751.2	101.5	0.1168	16.06 35.42
63.500 2.5000	47.625 1.8750	-0.8 -0.03	299.933 11.8084	11.112 0.4375	7.0 0.28	195.0 7.68	207.0 8.15	272.0 10.71	692.3	93.9	0.1287	16.01 35.30
47.625 1.8750	38.100 1.5000	4.8 0.19	254.691 10.0272	7.145 0.2813	3.5 0.14	188.0 7.40	194.0 7.64	241.0 9.49	622.3	122.6	0.1214	7.20 15.87
63.500 2.5000	46.038 1.8125	7.9 0.31	328.524 12.9340	11.112 0.4375	3.5 0.14	204.0 8.03	209.0 8.23	300.0 11.81	912.5	126.1	0.1460	21.71 47.87
63.500 2.5000	46.038 1.8125	7.9 0.31	328.524 12.9340	11.112 0.4375	4.3 0.17	212.0 8.35	218.0 8.58	300.0 11.81	912.5	126.1	0.1460	20.21 44.55
46.833 1.8438	38.100 1.5000	10.2 0.40	273.741 10.7772	7.145 0.2813	3.5 0.14	203.0 7.99	209.0 8.23	259.0 10.20	727.9	146.6	0.1310	8.08 17.82
47.625 1.8750	36.512 1.4375	3.8 0.15	291.998 11.4960	9.525 0.3750	3.5 0.14	206.0 8.11	211.0 8.31	272.0 10.71	574.6	130.8	0.1155	9.48 20.90
63.500 2.5000	46.038 1.8125	7.9 0.31	328.524 12.9340	11.112 0.4375	4.3 0.17	219.0 8.62	225.0 8.86	300.0 11.81	912.5	126.1	0.1460	18.75 41.34
63.500 2.5000	46.038 1.8125	7.9 0.31	328.524 12.9340	11.112 0.4375	4.3 0.17	222.0 8.74	227.0 8.94	300.0 11.81	912.5	126.1	0.1460	18.25 40.24
46.038 1.8125	36.512 1.4375	16.0 0.63	289.616 11.4022	7.145 0.2813	3.5 0.14	216.0 8.50	222.0 8.74	275.0 10.83	819.5	172.0	0.1388	8.81 19.44
46.038 1.8125	36.512 1.4375	16.0 0.63	289.616 11.4022	7.145 0.2813	3.5 0.14	219.0 8.62	224.0 8.82	275.0 10.83	819.5	172.0	0.1388	8.44 18.62
63.500 2.5000	46.038 1.8125	7.9 0.31	328.524 12.9340	11.112 0.4375	4.3 0.17	226.9 8.93	233.0 9.17	300.0 11.81	912.5	126.1	0.1460	17.23 37.98
93.662 3.6875	69.850 2.7500	-12.4 -0.49	425.450 16.7500	17.462 0.6875	6.4 0.25	241.0 9.49	251.0 9.88	385.1 15.16	1326.8	111.9	0.1509	53.70 118.42
46.038 1.8125	34.925 1.3750	14.2 0.56	293.685 11.5624	7.938 0.3125	3.5 0.14	227.0 8.94	233.0 9.17	280.0 11.02	866.9	225.2	0.1388	7.82 17.24
61.912 2.4375	49.212 1.9375	-4.6 -0.18	323.850 12.7500	9.525 0.3750	6.4 0.25	235.0 9.25	245.0 9.65	300.0 11.81	1149.7	141.4	0.1360	14.89 32.85

<sup>(4)</sup>Negative value indicates effective center inside cone (inner-ring) backface.

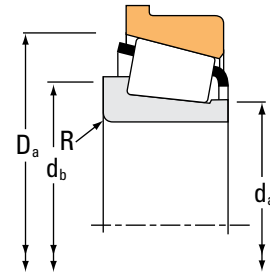
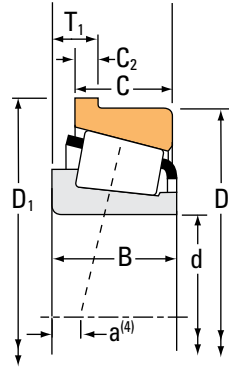
<sup>(5)</sup>These maximum fillet radii will be cleared by the bearing corners.

Continued on next page.

# TAPERED ROLLER BEARINGS

## SINGLE-ROW • TYPE TSF

### TYPE TSF



Bearing Dimensions			Load Ratings							Part Number	
Bore d	O.D. D	Width T <sub>1</sub>	Dynamic <sup>(1)</sup>			Dynamic <sup>(3)</sup>			Static C <sub>0</sub>	Inner	Outer
			C <sub>1</sub>	e	Y	C <sub>90</sub>	C <sub>a90</sub>	K			
mm in.	mm in.	mm in.	N lbf			N lbf	N lbf		N lbf		
220.662 8.6875	314.325 12.3750	22.225 0.8750	649000 146000	0.33	1.80	168000 37800	95800 21500	1.76	1240000 279000	M244249A	M244210-B
228.600 9.0000	355.600 14.0000	31.750 1.2500	759000 171000	0.59	1.02	197000 44200	199000 44700	0.99	1420000 319000	96900	96140-B
228.600 9.0000	327.025 12.8750	25.400 1.0000	558000 126000	0.41	1.48	145000 32500	101000 22700	1.44	1070000 240000	8573	8520-B
234.950 9.2500	328.612 12.9375	26.988 1.0625	552000 124000	0.49	1.23	143000 32200	119000 26800	1.20	821000 185000	88925	88129-B
241.300 9.5000	368.300 14.5000	26.988 1.0625	844000 190000	0.34	1.75	219000 49200	129000 28900	1.70	1530000 345000	EE125095	125145-B
241.300 9.5000	327.025 12.8750	25.400 1.0000	527000 119000	0.41	1.48	137000 30700	95200 21400	1.44	1070000 240000	8578	8520-B
244.475 9.6250	381.000 15.0000	34.925 1.3750	907000 204000	0.52	1.16	235000 52900	208000 46800	1.13	1690000 381000	EE126097	126150-B
253.975 9.9990	330.000 12.9921	17.000 0.6693	360000 80800	0.56	1.07	93200 21000	89100 20000	1.05	715000 161000	L848849	JL848815-B
254.000 10.0000	403.225 15.8750	38.100 1.5000	1010000 228000	0.40	1.49	262000 59000	181000 40600	1.45	1600000 359000	EE275100	275158-B
254.000 10.0000	358.775 14.1250	30.162 1.1875	914000 206000	0.33	1.80	237000 53300	135000 30300	1.76	1850000 416000	M249749	M249710-B
254.000 10.0000	358.775 14.1250	30.162 1.1875	835000 188000	0.33	1.80	217000 48700	123000 27700	1.76	1630000 366000	M249749AH	M249711-B
254.000 10.0000	315.912 12.4375	14.526 0.5719	255000 57300	0.43	1.39	66100 14900	48700 10900	1.36	561000 126000	LL648449	LL648415-B
260.350 10.2500	400.050 15.7500	38.100 1.5000	949000 213000	0.39	1.52	246000 55300	166000 37400	1.48	1450000 326000	EE221026	221575-B
264.975 10.4321	349.948 13.7775	18.699 0.7362	333000 74900	0.54	1.11	86300 19400	79600 17900	1.08	750000 169000	L853042	L853011-B
266.700 10.5000	403.225 15.8750	38.100 1.5000	1010000 228000	0.40	1.49	262000 59000	181000 40600	1.45	1600000 359000	EE275105	275158-B
266.700 10.5000	355.600 14.0000	22.225 0.8750	880000 198000	0.36	1.67	228000 51300	141000 31600	1.62	1510000 339000	LM451349	LM451310-B
273.050 10.7500	403.225 15.8750	38.100 1.5000	1010000 228000	0.40	1.49	262000 59000	181000 40600	1.45	1600000 359000	EE275108	275158-B

<sup>(1)</sup>Based on  $1 \times 10^6$  revolutions  $L_{10}$  life, for the ISO life-calculation method.

<sup>(2)</sup>Consult your Timken engineer for instructions on use or review the Timken Engineering Manual on [timken.com/catalogs](http://timken.com/catalogs).

<sup>(3)</sup>Based on  $90 \times 10^6$  revolutions  $L_{10}$  life, for The Timken Company life-calculation method.  $C_{90}$  and  $C_{a90}$  are radial and thrust values.

Bearing Dimensions									Geometry Factors			Bearing Weight
Width B	Width C	Eff. Ctr. a <sup>(4)</sup>	Outer Ring Flange O.D. D <sub>1</sub>	Flange Width C <sub>2</sub>	Shaft			Housing	G <sub>1</sub>	G <sub>2</sub>	C <sub>g</sub>	
					Max Shaft Fillet Radius R <sup>(5)</sup>	Backing Shoulder Dia.		Backing Shoulder Dia. D <sub>a</sub>				
mm in.	mm in.	mm in.	mm in.	mm in.	mm in.	mm in.	mm in.	mm in.				kg lbs.
66.675 2.6250	49.212 1.9375	-4.6 -0.18	323.850 12.7500	9.525 0.3750	1.5 0.06	235.0 9.25	235.0 9.25	300.0 11.81	1073.1	132.4	0.1327	15.28 33.70
66.675 2.6250	47.625 1.8750	17.0 0.67	366.624 14.4340	11.112 0.4375	7.0 0.28	249.0 9.80	260.0 10.24	334.0 13.15	1140.0	160.6	0.1626	24.33 53.64
52.388 2.0625	36.512 1.4375	7.6 0.30	336.448 13.2460	9.525 0.3750	6.4 0.25	244.0 9.61	255.0 10.04	313.0 12.32	1050.5	172.4	0.1401	13.74 30.30
49.212 1.9375	34.925 1.3750	14.2 0.56	339.725 13.3750	9.525 0.3750	6.4 0.25	246.0 9.69	258.0 10.16	309.0 12.17	800.1	189.1	0.1352	11.83 26.09
68.262 2.6875	53.975 2.1250	-2.3 -0.09	380.898 14.9960	12.700 0.5000	6.4 0.25	257.0 10.12	269.0 10.59	354.1 13.94	1309.0	221.1	0.1432	24.83 54.75
52.388 2.0625	36.512 1.4375	7.6 0.30	336.448 13.2460	9.525 0.3750	6.4 0.25	253.0 9.96	264.0 10.39	313.0 12.32	1050.5	172.4	0.1401	11.81 26.05
76.200 3.0000	57.150 2.2500	9.7 0.38	393.598 15.4960	12.700 0.5000	6.4 0.25	266.0 10.47	275.0 10.83	358.0 14.09	1321.8	168.9	0.1640	31.90 70.32
41.500 1.6339	28.000 1.1024	32.0 1.26	342.000 13.4646	6.000 0.2362	1.5 0.06	266.0 10.47	266.0 10.47	320.0 12.60	868.9	255.1	0.1442	8.31 18.34
69.850 2.7500	46.038 1.8125	2.5 0.10	417.408 16.4334	14.288 0.5625	6.4 0.25	277.0 10.91	287.0 11.30	389.0 15.31	1451.8	201.3	0.1555	31.88 70.28
71.438 2.8125	53.975 2.1250	-6.9 -0.27	371.475 14.6250	12.700 0.5000	3.5 0.14	270.0 10.63	274.0 10.79	343.0 13.50	1626.0	173.0	0.1526	22.21 48.96
76.200 3.0000	53.975 2.1250	-6.9 -0.27	384.175 15.1250	12.700 0.5000	1.5 0.06	270.0 10.63	270.0 10.63	343.0 13.50	1485.4	158.7	0.1477	23.06 50.86
31.750 1.2500	22.225 0.8750	22.4 0.88	323.924 12.7529	5.001 0.1969	3.5 0.14	262.0 10.31	268.0 10.55	305.0 12.01	817.0	322.2	0.1295	5.03 11.09
67.470 2.6563	46.038 1.8125	0.8 0.03	414.233 16.3084	14.288 0.5625	9.7 0.38	280.0 11.02	296.0 11.65	383.0 15.08	1320.8	207.5	0.1497	27.98 61.69
34.925 1.3750	23.812 0.9375	35.1 1.38	357.950 14.0925	5.999 0.2362	3.5 0.14	280.0 11.02	285.0 11.22	342.0 13.46	1057.3	350.4	0.1517	8.89 19.61
69.850 2.7500	46.038 1.8125	2.5 0.10	417.408 16.4334	14.288 0.5625	6.4 0.25	287.0 11.30	296.0 11.65	389.0 15.31	1451.8	201.3	0.1555	29.03 64.01
57.150 2.2500	44.450 1.7500	5.1 0.20	365.125 14.3750	9.525 0.3750	3.5 0.14	281.0 11.06	285.0 11.22	344.0 13.54	1554.1	212.2	0.1536	15.69 34.61
69.850 2.7500	46.038 1.8125	2.5 0.10	417.408 16.4334	14.288 0.5625	6.4 0.25	291.0 11.46	301.0 11.85	389.0 15.31	1451.8	201.3	0.1555	27.65 60.95

<sup>(4)</sup>Negative value indicates effective center inside cone (inner-ring) backface.

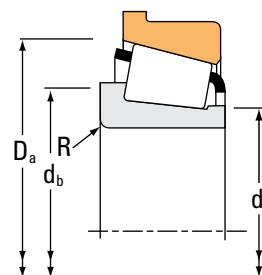
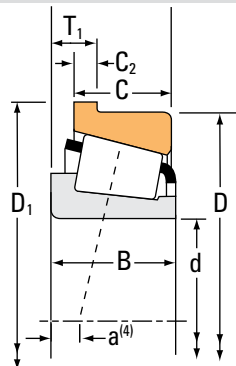
<sup>(5)</sup>These maximum fillet radii will be cleared by the bearing corners.

Continued on next page.

# TAPERED ROLLER BEARINGS

## SINGLE-ROW • TYPE TSF

### TYPE TSF



Bearing Dimensions			Load Ratings							Part Number		
Bore d	O.D. D	Width T <sub>1</sub>	Dynamic <sup>(1)</sup>		Factors <sup>(2)</sup>		Dynamic <sup>(3)</sup>		Factors <sup>(2)</sup>	Static	Inner	Outer
			C <sub>1</sub>	e	Y	C <sub>90</sub>	C <sub>a90</sub>	K	C <sub>0</sub>			
mm in.	mm in.	mm in.	N lbf			N lbf	N lbf			N lbf		
276.225 10.8750	349.948 13.7775	18.699 0.7362	333000 74900	0.54	1.11	86300 19400	79600 17900	1.08		750000 169000	L853049	L853011-B
280.000 11.0236	406.400 16.0000	28.575 1.1250	924000 208000	0.39	1.55	240000 53900	158000 35600	1.51		1820000 409000	EE128114	128160-B
280.192 11.0312	406.400 16.0000	28.575 1.1250	868000 195000	0.39	1.55	225000 50600	149000 33400	1.51		1660000 374000	EE128111	128160-B
280.192 11.0312	406.400 16.0000	28.575 1.1250	924000 208000	0.39	1.55	240000 53900	158000 35600	1.51		1820000 409000	EE128110	128160-B
285.750 11.2500	380.898 14.9960	25.400 1.0000	722000 162000	0.43	1.39	187000 42100	138000 31100	1.35		1720000 387000	LM654649	LM654610-B
289.975 11.4163	404.950 15.9429	22.225 0.8750	586000 132000	0.36	1.67	152000 34200	93500 21000	1.63		1310000 295000	L357040	L357019-B
298.450 11.7500	444.500 17.5000	36.512 1.4375	887000 199000	0.38	1.59	230000 51700	149000 33400	1.55		1390000 312000	EE291175	291750-B
304.800 12.0000	444.500 17.5000	36.512 1.4375	887000 199000	0.38	1.59	230000 51700	149000 33400	1.55		1390000 312000	EE291201	291750-B
304.800 12.0000	406.400 16.0000	25.400 1.0000	769000 173000	0.44	1.36	199000 44800	151000 33900	1.32		1740000 392000	LM757049	LM757010-B
304.800 12.0000	404.950 15.9429	22.225 0.8750	586000 132000	0.36	1.67	152000 34200	93500 21000	1.63		1310000 295000	L357049	L357019-B
317.500 12.5000	444.500 17.5000	36.512 1.4375	887000 199000	0.38	1.59	230000 51700	149000 33400	1.55		1390000 312000	EE291250	291750-B
330.200 13.0000	482.600 19.0000	36.512 1.4375	1030000 231000	0.42	1.44	266000 59900	190000 42700	1.40		1770000 398000	EE203130	203190-B
330.200 13.0000	482.600 19.0000	41.275 1.6250	1250000 281000	0.39	1.54	324000 72900	217000 48700	1.49		2320000 523000	EE526130	526190-B
346.075 13.6250	482.600 19.0000	36.512 1.4375	1030000 231000	0.42	1.44	266000 59900	190000 42700	1.40		1770000 398000	EE203136	203190-B
349.250 13.7500	501.650 19.7500	34.925 1.3750	1350000 304000	0.37	1.63	350000 78700	220000 49500	1.59		2780000 626000	EE333137	333197-B
371.475 14.6250	508.000 20.0000	38.100 1.5000	1050000 236000	0.44	1.36	273000 61300	206000 46200	1.33		1870000 420000	EE231462	232000-B
374.650 14.7500	522.288 20.5625	38.100 1.5000	1390000 313000	0.39	1.56	360000 81000	238000 53500	1.51		2950000 663000	LM565943	LM565910-B

<sup>(1)</sup>Based on 1 x 10<sup>6</sup> revolutions L<sub>10</sub> life, for the ISO life-calculation method.

<sup>(2)</sup>Consult your Timken engineer for instructions on use or review the Timken Engineering Manual on timken.com/catalogs.

<sup>(3)</sup>Based on 90 x 10<sup>6</sup> revolutions L<sub>10</sub> life, for The Timken Company life-calculation method. C<sub>90</sub> and C<sub>a90</sub> are radial and thrust values.

Bearing Dimensions									Geometry Factors			Bearing Weight
Width B	Width C	Eff. Ctr. a <sup>(4)</sup>	Outer Ring Flange O.D. D <sub>1</sub>	Flange Width C <sub>2</sub>	Shaft			Housing	G <sub>1</sub>	G <sub>2</sub>	C <sub>g</sub>	
					Max Shaft Fillet Radius R <sup>(5)</sup>	Backing Shoulder Dia. d <sub>a</sub>	Backing Shoulder Dia. d <sub>b</sub>	Backing Shoulder Dia. D <sub>a</sub>				
mm in.	mm in.	mm in.	mm in.	mm in.	mm in.	mm in.	mm in.	mm in.				kg lbs.
34.925 1.3750	23.812 0.9375	35.1 1.38	357.950 14.0925	5.999 0.2362	3.5 0.14	288.0 11.34	293.0 11.54	342.0 13.46	1057.3	350.4	0.1517	7.61 16.78
67.673 2.6643	53.975 2.1250	6.6 0.26	418.998 16.4960	12.700 0.5000	6.4 0.25	307.0 12.09	308.0 12.13	384.0 15.12	1727.7	255.2	0.1628	29.02 64.00
67.673 2.6643	53.975 2.1250	6.6 0.26	418.998 16.4960	12.700 0.5000	6.8 0.27	307.0 12.09	309.0 12.17	384.0 15.12	1622.7	240.4	0.1592	27.99 61.73
67.673 2.6643	53.975 2.1250	6.6 0.26	418.998 16.4960	12.700 0.5000	6.8 0.27	307.0 12.09	309.0 12.17	384.0 15.12	1727.7	255.2	0.1628	28.95 63.85
65.088 2.5625	49.212 1.9375	11.4 0.45	390.423 15.3710	9.525 0.3750	3.5 0.14	302.0 11.89	306.0 12.05	368.0 14.49	1916.4	265.6	0.1744	20.07 44.22
50.800 2.0000	38.100 1.5000	12.7 0.50	419.923 16.5324	9.525 0.3750	6.4 0.25	308.0 12.13	318.0 12.52	380.0 14.96	1753.3	301.0	0.1585	20.08 44.25
61.912 2.4375	39.688 1.5625	7.6 0.30	457.098 17.9960	12.700 0.5000	8.0 0.31	320.0 12.60	332.0 13.07	428.0 16.85	1579.2	244.8	0.1557	30.48 67.19
61.912 2.4375	39.688 1.5625	7.6 0.30	457.098 17.9960	12.700 0.5000	8.0 0.31	324.0 12.76	337.0 13.27	428.0 16.85	1579.2	244.8	0.1557	29.02 63.97
63.500 2.5000	47.625 1.8750	16.3 0.64	419.100 16.5000	9.525 0.3750	6.4 0.25	322.0 12.68	331.0 13.03	393.0 15.47	1988.6	260.3	0.1775	22.05 48.61
50.800 2.0000	38.100 1.5000	12.7 0.50	419.923 16.5324	9.525 0.3750	6.4 0.25	319.0 12.56	329.0 12.95	380.0 14.96	1753.3	301.0	0.1585	17.32 38.17
61.912 2.4375	39.688 1.5625	7.6 0.30	457.098 17.9960	12.700 0.5000	8.0 0.31	334.0 13.15	346.0 13.62	428.0 16.85	1579.2	244.8	0.1557	26.00 57.32
63.500 2.5000	44.450 1.7500	16.3 0.64	496.788 19.5586	14.288 0.5625	6.8 0.27	354.0 13.94	364.0 14.33	466.0 18.35	2138.1	336.0	0.1778	37.38 82.39
80.167 3.1562	60.325 2.3750	4.8 0.19	498.373 19.6210	15.875 0.6250	6.4 0.25	351.0 13.82	360.0 14.17	464.0 18.27	2283.3	287.2	0.1790	46.63 102.79
63.500 2.5000	44.450 1.7500	16.3 0.64	496.788 19.5586	14.288 0.5625	6.8 0.27	366.0 14.41	376.0 14.80	466.0 18.35	2138.1	336.0	0.1778	33.18 73.14
84.138 3.3125	69.850 2.7500	3.6 0.14	515.838 20.3086	14.288 0.5625	6.4 0.25	372.0 14.65	382.0 15.04	486.0 19.13	3037.5	334.7	0.1928	54.36 119.85
66.675 2.6250	50.800 2.0000	19.6 0.77	522.188 20.5586	14.288 0.5625	6.4 0.25	390.0 15.35	400.0 15.75	489.0 19.25	2386.0	366.8	0.1874	37.37 82.40
84.138 3.3125	61.912 2.4375	8.9 0.35	536.476 21.1211	14.288 0.5625	6.4 0.25	397.0 15.63	407.0 16.02	507.0 19.96	3379.9	375.8	0.2028	52.86 116.53

<sup>(4)</sup>Negative value indicates effective center inside cone (inner-ring) backface.

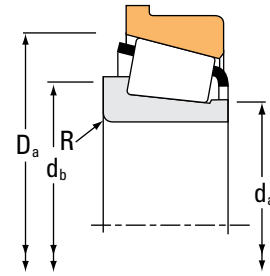
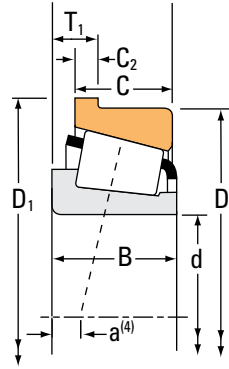
<sup>(5)</sup>These maximum fillet radii will be cleared by the bearing corners.

Continued on next page.

# TAPERED ROLLER BEARINGS

## SINGLE-ROW • TYPE TSF

### TYPE TSF



Bearing Dimensions			Load Ratings							Part Number	
Bore d	O.D. D	Width T <sub>1</sub>	Dynamic <sup>(1)</sup>			Dynamic <sup>(3)</sup>			Static C <sub>0</sub>	Inner	Outer
			C <sub>1</sub>	e	Y	C <sub>90</sub>	C <sub>a90</sub>	K			
mm in.	mm in.	mm in.	N lbf			N lbf	N lbf		N lbf		
377.825 14.8750	522.288 20.5625	38.100 1.5000	1390000 313000	0.39	1.56	360000 81000	238000 53500	1.51	2950000 663000	LM565946	LM565910-B
381.000 15.0000	522.288 20.5625	38.100 1.5000	1390000 313000	0.39	1.56	360000 81000	238000 53500	1.51	2950000 663000	LM565949	LM565910-B
381.000 15.0000	479.425 18.8750	23.812 0.9375	594000 133000	0.50	1.21	154000 34600	130000 29300	1.18	1380000 311000	L865547	L865512-B
396.875 15.6250	549.275 21.6250	38.100 1.5000	1430000 322000	0.41	1.47	371000 83500	259000 58200	1.43	3130000 704000	LM567943	LM567910-B
403.225 15.8750	460.375 18.1250	12.700 0.5000	230000 51700	0.40	1.49	59600 13400	41000 9210	1.45	708000 159000	LL566848	LL566810-B
406.400 16.0000	549.275 21.6250	38.100 1.5000	1430000 322000	0.41	1.47	371000 83500	259000 58200	1.43	3130000 704000	LM567949	LM567910-B
406.400 16.0000	508.000 20.0000	25.400 1.0000	859000 193000	0.37	1.64	223000 50100	139000 31300	1.60	2230000 502000	L467549	L467510-B
431.800 17.0000	533.400 21.0000	20.638 0.8125	624000 140000	0.31	1.96	162000 36400	84700 19000	1.91	1520000 342000	80385	80325-B
450.850 17.7500	603.250 23.7500	39.688 1.5625	1490000 335000	0.45	1.32	386000 86800	300000 67300	1.29	3440000 773000	LM770945	LM770910-B
457.200 18.0000	603.250 23.7500	39.688 1.5625	1490000 335000	0.45	1.32	386000 86800	300000 67300	1.29	3440000 773000	LM770949	LM770910-B
457.200 18.0000	596.900 23.5000	76.200 3.0000	1410000 318000	0.40	1.48	367000 82400	254000 57100	1.44	2890000 649000	EE244180	244235-B
482.600 19.0000	634.873 24.9950	31.750 1.2500	1470000 330000	0.34	1.75	380000 85500	223000 50200	1.70	3660000 822000	EE243190	243250-B
488.950 19.2500	660.400 26.0000	38.100 1.5000	2370000 533000	0.31	1.95	614000 138000	323000 72600	1.90	4590000 1030000	EE640192	640260-B
489.026 19.2530	634.873 24.9950	31.750 1.2500	1470000 330000	0.34	1.75	380000 85500	223000 50200	1.70	3660000 822000	EE243192	243250-B
498.475 19.6250	634.873 24.9950	31.750 1.2500	1470000 330000	0.34	1.75	380000 85500	223000 50200	1.70	3660000 822000	EE243196	243250-B
596.900 23.5000	685.800 27.0000	13.492 0.5312	344000 77300	0.53	1.14	89200 20000	80400 18100	1.11	963000 217000	680235	680270-B
647.700 25.5000	736.600 29.0000	13.495 0.5313	406000 91300	0.35	1.71	105000 23700	63200 14200	1.67	1170000 264000	LL380849	LL380810-B

<sup>(1)</sup>Based on  $1 \times 10^6$  revolutions  $L_{10}$  life, for the ISO life-calculation method.

<sup>(2)</sup>Consult your Timken engineer for instructions on use or review the Timken Engineering Manual on [timken.com/catalogs](http://timken.com/catalogs).

<sup>(3)</sup>Based on  $90 \times 10^6$  revolutions  $L_{10}$  life, for The Timken Company life-calculation method.  $C_{90}$  and  $C_{a90}$  are radial and thrust values.

Bearing Dimensions									Geometry Factors			Bearing Weight
Width B	Width C	Eff. Ctr. a <sup>(4)</sup>	Outer Ring Flange O.D. D <sub>1</sub>	Flange Width C <sub>2</sub>	Shaft			Housing	G <sub>1</sub>	G <sub>2</sub>	C <sub>g</sub>	
					Max Shaft Fillet Radius R <sup>(5)</sup>	Backing Shoulder Dia. d <sub>a</sub>	Backing Shoulder Dia. d <sub>b</sub>	Backing Shoulder Dia. D <sub>a</sub>				
mm in.	mm in.	mm in.	mm in.	mm in.	mm in.	mm in.	mm in.	mm in.				kg lbs.
84.138 3.3125	61.912 2.4375	8.9 0.35	536.476 21.1211	14.288 0.5625	6.4 0.25	399.0 15.71	409.0 16.10	507.0 19.96	3379.9	375.8	0.2028	51.62 113.80
84.138 3.3125	61.912 2.4375	8.9 0.35	536.476 21.1211	14.288 0.5625	6.4 0.25	402.0 15.83	411.0 16.18	507.0 19.96	3379.9	375.8	0.2028	50.42 111.16
47.625 1.8750	34.925 1.3750	42.9 1.69	489.737 19.2810	9.525 0.3750	6.4 0.25	395.0 15.55	407.0 16.02	465.0 18.31	2256.6	529.8	0.1897	18.97 41.81
84.138 3.3125	61.912 2.4375	15.5 0.61	563.463 22.1836	14.288 0.5625	6.4 0.25	420.0 16.54	430.0 16.93	531.0 20.91	3796.2	424.8	0.2143	58.63 129.27
28.575 1.1250	22.225 0.8750	41.4 1.63	469.900 18.5000	6.350 0.2500	3.5 0.14	414.0 16.30	418.0 16.46	452.0 17.80	2302.0	1585.3	0.2225	7.00 15.44
84.138 3.3125	61.912 2.4375	15.5 0.61	563.463 22.1836	14.288 0.5625	6.4 0.25	427.0 16.81	437.0 17.20	531.0 20.91	3796.2	424.8	0.2143	54.17 119.42
61.912 2.4375	47.625 1.8750	20.3 0.80	519.013 20.4336	11.112 0.4375	3.3 0.13	423.0 16.65	426.0 16.77	492.0 19.37	3716.5	673.8	0.2038	27.95 61.62
46.038 1.8125	34.925 1.3750	23.4 0.92	542.925 21.3750	9.525 0.3750	3.3 0.13	446.0 17.56	450.0 17.72	510.0 20.08	3209.2	802.4	0.1815	21.04 46.37
84.138 3.3125	60.325 2.3750	30.5 1.20	617.438 24.3086	14.288 0.5625	6.4 0.25	474.0 18.66	484.0 19.06	579.7 22.82	4660.5	534.5	0.2366	65.09 143.51
84.138 3.3125	60.325 2.3750	30.5 1.20	617.438 24.3086	14.288 0.5625	6.4 0.25	479.0 18.86	489.0 19.25	579.7 22.82	4660.5	534.5	0.2366	61.09 134.69
73.025 2.8750	53.975 2.1250	26.7 1.05	611.200 24.0630	14.300 0.5630	9.7 0.38	478.0 18.82	494.0 19.45	570.0 22.47	4411.8	627.1	0.2233	51.04 112.51
80.962 3.1875	63.500 2.5000	19.1 0.75	649.199 25.5590	14.288 0.5625	6.4 0.25	510.0 20.08	516.0 20.31	618.0 24.33	6057.3	726.6	0.2350	67.90 149.71
94.458 3.7188	69.850 2.7500	4.8 0.19	676.275 26.6250	14.288 0.5625	6.4 0.25	513.0 20.20	522.0 20.55	642.0 25.28	6322.4	601.7	0.2310	90.10 198.61
80.962 3.1875	63.500 2.5000	19.1 0.75	649.199 25.5590	14.288 0.5625	6.4 0.25	516.0 20.31	522.0 20.55	618.0 24.33	6057.3	726.6	0.2350	64.58 142.37
80.962 3.1875	63.500 2.5000	19.1 0.75	649.199 25.5590	14.288 0.5625	6.4 0.25	522.0 20.55	528.0 20.79	618.0 24.33	6057.3	726.6	0.2350	60.14 132.60
31.750 1.2500	25.400 1.0000	96.0 3.78	692.841 27.2772	7.142 0.2812	3.5 0.14	615.0 24.21	615.0 24.21	669.0 26.34	3739.1	1810.4	0.2225	16.93 37.33
31.750 1.2500	25.400 1.0000	64.3 2.53	743.636 29.2770	7.145 0.2813	3.5 0.14	660.0 25.98	666.0 26.22	720.0 28.35	5165.7	2840.6	0.2172	19.15 42.21

<sup>(4)</sup>Negative value indicates effective center inside cone (inner-ring) backface.

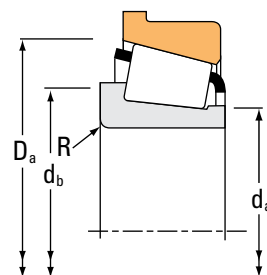
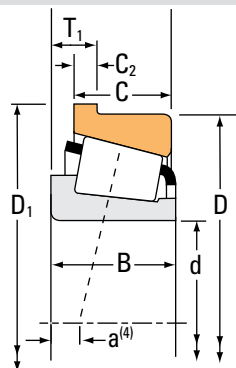
<sup>(5)</sup>These maximum fillet radii will be cleared by the bearing corners.

Continued on next page.

# TAPERED ROLLER BEARINGS

## SINGLE-ROW • TYPE TSF

### TYPE TSF



Bearing Dimensions			Load Ratings							Part Number		
Bore d	O.D. D	Width T <sub>1</sub>	Dynamic <sup>(1)</sup>		Factors <sup>(2)</sup>		Dynamic <sup>(3)</sup>		Factors <sup>(2)</sup>	Static	Inner	Outer
			C <sub>1</sub>	e	Y	C <sub>90</sub>	C <sub>a90</sub>	K	C <sub>0</sub>			
mm in.	mm in.	mm in.	N lbf			N lbf	N lbf			N lbf		
736.600 29.0000	825.500 32.5000	12.700 0.5000	424000 95300	0.40	1.51	110000 24700	74800 16800	1.47		1300000 291000	LL582949	LL582910-B
1063.625 41.8750	1219.200 48.0000	34.925 1.3750	1720000 386000	0.48	1.26	445000 100000	362000 81400	1.23		5660000 1270000	LL788345	LL788310-B
1066.800 42.0000	1219.200 48.0000	34.925 1.3750	1720000 386000	0.48	1.26	445000 100000	362000 81400	1.23		5660000 1270000	LL788349	LL788310-B
1270.000 50.0000	1435.100 56.5000	36.512 1.4375	1840000 414000	0.57	1.05	478000 107000	467000 105000	1.02		6650000 1500000	LL889049	LL889010-B

<sup>(1)</sup>Based on 1 x 10<sup>6</sup> revolutions L<sub>10</sub> life, for the ISO life-calculation method.

<sup>(2)</sup>Consult your Timken engineer for instructions on use or review the Timken Engineering Manual on [timken.com/catalogs](http://timken.com/catalogs).

<sup>(3)</sup>Based on 90 x 10<sup>6</sup> revolutions L<sub>10</sub> life, for The Timken Company life-calculation method. C<sub>90</sub> and C<sub>a90</sub> are radial and thrust values.



Bearing Dimensions									Geometry Factors			Bearing Weight
Width B	Width C	Eff. Ctr. a <sup>(4)</sup>	Outer Ring Flange O.D. D <sub>1</sub>	Flange Width C <sub>2</sub>	Shaft			Housing	G <sub>1</sub>	G <sub>2</sub>	C <sub>g</sub>	
					Max Shaft Fillet Radius R <sup>(5)</sup>	Backing Shoulder Dia.		Backing Shoulder Dia. D <sub>a</sub>				
mm in.	mm in.	mm in.	mm in.	mm in.	mm in.	mm in.	mm in.	mm in.				kg lbs.
<b>31.750</b> 1.2500	<b>25.400</b> 1.0000	<b>86.9</b> 3.42	<b>833.435</b> 32.8124	<b>6.350</b> 0.2500	<b>3.5</b> 0.14	<b>753.1</b> 29.65	<b>753.1</b> 29.65	<b>807.0</b> 31.77	6526.9	3683.4	0.2436	<b>21.01</b> 46.30
<b>65.088</b> 2.5625	<b>42.862</b> 1.6875	<b>142.5</b> 5.61	<b>1231.900</b> 48.5000	<b>12.700</b> 0.5000	<b>3.3</b> 0.13	<b>1085.0</b> 42.72	<b>1090.0</b> 42.91	<b>1200.0</b> 47.24	22182.4	4652.2	0.3922	<b>113.74</b> 250.78
<b>65.088</b> 2.5625	<b>42.862</b> 1.6875	<b>142.5</b> 5.61	<b>1231.900</b> 48.5000	<b>12.700</b> 0.5000	<b>3.3</b> 0.13	<b>1090.0</b> 42.91	<b>1090.0</b> 42.91	<b>1200.0</b> 47.24	22182.4	4652.2	0.3922	<b>111.04</b> 244.81
<b>65.088</b> 2.5625	<b>47.625</b> 1.8750	<b>216.9</b> 8.54	<b>1454.150</b> 57.2500	<b>14.288</b> 0.5625	<b>6.4</b> 0.25	<b>1300.0</b> 51.18	<b>1305.0</b> 51.38	<b>1415.0</b> 55.71	31422.7	5654.9	0.4637	<b>151.19</b> 333.35

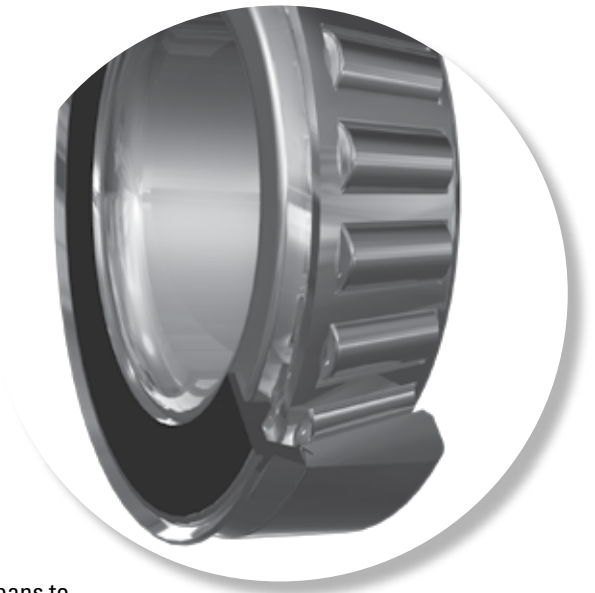
<sup>(4)</sup>Negative value indicates effective center inside cone (inner-ring) backface.

<sup>(5)</sup>These maximum fillet radii will be cleared by the bearing corners.



### ***TYPE TSL***

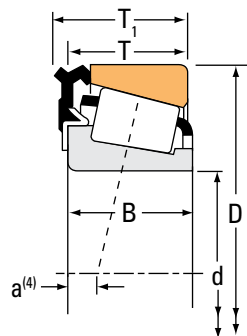
- TSL is a single-row bearing with a DUO-FACE PLUS seal pressed on to the large rib of the inner ring.
- One lip of the DUO-FACE PLUS seal operates in the housing bore, the other lip seals against the hardened and ground surface of the outer-ring front face.
- This bearing provides an effective means to integrate a seal into grease-lubricated applications operating at moderate speeds.
- Consult your Timken engineer before making a final bearing selection to help ensure suitability, availability and the most cost-effective application.



# TAPERED ROLLER BEARINGS

## SINGLE-ROW • TYPE TSL

### TYPE TSL



Bearing Dimensions				Load Ratings						
Bore d	O.D. D	Width T	Width T <sub>1</sub>	Dynamic <sup>(1)</sup>	Factors <sup>(2)</sup>		Dynamic <sup>(3)</sup>		Factors <sup>(2)</sup>	Static
				C <sub>1</sub>	e	Y	C <sub>90</sub>	C <sub>a90</sub>	K	C <sub>0</sub>
mm in.	mm in.	mm in.	mm in.	N lbf			N lbf	N lbf		N lbf
<b>19.050</b> 0.7500	<b>45.237</b> 1.7810	<b>15.494</b> 0.6100	<b>16.281</b> 0.6410	<b>39100</b> 8800	0.30	2.00	<b>10100</b> 2280	<b>5220</b> 1170	1.94	<b>32000</b> 7200
<b>19.050</b> 0.7500	<b>45.237</b> 1.7810	<b>16.281</b> 0.6410	<b>17.400</b> 0.6850	<b>39100</b> 8800	0.30	2.00	<b>10100</b> 2280	<b>5220</b> 1170	1.94	<b>32000</b> 7200
<b>21.430</b> 0.8437	<b>50.005</b> 1.9687	<b>18.313</b> 0.7210	<b>19.430</b> 0.7650	<b>52200</b> 11700	0.28	2.16	<b>13500</b> 3040	<b>6440</b> 1450	2.10	<b>43500</b> 9780
<b>25.400</b> 1.0000	<b>50.005</b> 1.9687	<b>14.206</b> 0.5593	<b>15.400</b> 0.6060	<b>29100</b> 6540	0.40	1.49	<b>7550</b> 1700	<b>5190</b> 1170	1.45	<b>29600</b> 6650
<b>25.400</b> 1.0000	<b>50.292</b> 1.9800	<b>14.224</b> 0.5600	<b>14.935</b> 0.5880	<b>35600</b> 8010	0.37	1.60	<b>9230</b> 2080	<b>5910</b> 1330	1.56	<b>32900</b> 7400
<b>25.400</b> 1.0000	<b>50.292</b> 1.9800	<b>14.935</b> 0.5880	<b>16.130</b> 0.6350	<b>35600</b> 8010	0.37	1.60	<b>9230</b> 2080	<b>5910</b> 1330	1.56	<b>32900</b> 7400
<b>25.400</b> 1.0000	<b>50.292</b> 1.9800	<b>14.935</b> 0.5880	<b>16.130</b> 0.6350	<b>35600</b> 8010	0.37	1.60	<b>9230</b> 2080	<b>5910</b> 1330	1.56	<b>32900</b> 7400
<b>31.750</b> 1.2500	<b>59.131</b> 2.3280	<b>16.637</b> 0.6550	<b>17.780</b> 0.7000	<b>46700</b> 10500	0.41	1.46	<b>12100</b> 2720	<b>8550</b> 1920	1.42	<b>44600</b> 10000
<b>34.925</b> 1.3750	<b>65.088</b> 2.5625	<b>18.796</b> 0.7400	<b>19.940</b> 0.7850	<b>64600</b> 14500	0.38	1.59	<b>16700</b> 3760	<b>10800</b> 2430	1.55	<b>63100</b> 14200
<b>38.100</b> 1.5000	<b>65.088</b> 2.5625	<b>18.796</b> 0.7400	<b>19.940</b> 0.7850	<b>48600</b> 10900	0.33	1.80	<b>12600</b> 2830	<b>7170</b> 1610	1.76	<b>60300</b> 13600
<b>38.100</b> 1.5000	<b>69.012</b> 2.7170	<b>19.050</b> 0.7500	<b>20.190</b> 0.7950	<b>67200</b> 15100	0.40	1.49	<b>17400</b> 3920	<b>12000</b> 2700	1.45	<b>67900</b> 15300
<b>38.100</b> 1.5000	<b>69.012</b> 2.7170	<b>19.812</b> 0.7800	<b>20.960</b> 0.8250	<b>67200</b> 15100	0.40	1.49	<b>17400</b> 3920	<b>12000</b> 2700	1.45	<b>67900</b> 15300
<b>63.500</b> 2.5000	<b>110.000</b> 4.3307	<b>23.218</b> 0.9141	<b>23.218</b> 0.9141	<b>98900</b> 22200	0.40	1.49	<b>25600</b> 5760	<b>17600</b> 3970	1.45	<b>125000</b> 28100
<b>68.262</b> 2.6875	<b>110.000</b> 4.3307	<b>23.218</b> 0.9141	<b>24.640</b> 0.9700	<b>98900</b> 22200	0.40	1.49	<b>25600</b> 5760	<b>17600</b> 3970	1.45	<b>125000</b> 28100

<sup>(1)</sup>Based on  $1 \times 10^6$  revolutions  $L_{10}$  life, for the ISO life-calculation method.

<sup>(2)</sup>Consult your Timken engineer for instructions on use or review the Timken Engineering Manual on [timken.com/catalogs](http://timken.com/catalogs).

<sup>(3)</sup>Based on  $90 \times 10^6$  revolutions  $L_{10}$  life, for The Timken Company life-calculation method.  $C_{90}$  and  $C_{a90}$  are radial and thrust values.

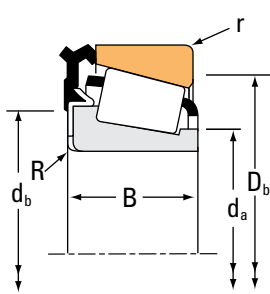


Fig. 1. Backing shoulder against seal backface.

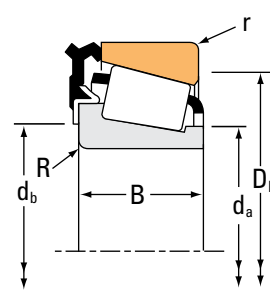
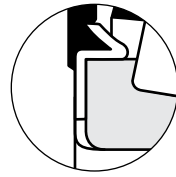
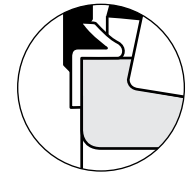


Fig. 2. Backing shoulder against cone (inner-ring) backface (below seal).



Part Number				Bearing Dimensions							Geometry Factors			Bearing Weight
Inner	Outer	Seal	Fig.	Bearing		Shaft			Housing		G <sub>1</sub>	G <sub>2</sub>	C <sub>g</sub>	
				Inner Ring Width B	Eff. Ctr. a <sup>(4)</sup>	Max. Shaft Fillet Radius R <sup>(5)</sup>	Backing Shoulder Dia. d <sub>a</sub>	Backing Shoulder Dia. d <sub>b</sub>	Max. Housing Fillet Radius r <sup>(5)</sup>	Backing Shoulder Dia. D <sub>b</sub>				
				mm in.	mm in.	mm in.	mm in.	mm in.	mm in.	mm in.				kg lbs.
LM11949	LM11910	LM11900EA	2	16.637 0.6550	-5.6 -0.22	1.3 0.05	23.5 0.93	25.0 0.98	1.3 0.05	39.5 1.56	6.6	5.5	0.0441	0.12 0.28
LM11949	LM11910	LM11900LA	1	16.637 0.6550	-5.6 -0.22	1.3 0.05	23.5 0.93	25.0 0.98	1.3 0.05	39.5 1.56	6.6	5.5	0.0441	0.12 0.28
M12649	M12610	M12600LA	1	18.288 0.7200	-6.4 -0.25	1.3 0.05	27.5 1.08	29.5 1.16	1.3 0.05	44.0 1.73	9.1	5.6	0.0479	0.17 0.37
07100	07196	07000LA	1	14.260 0.5614	-2.8 -0.11	1.0 0.04	29.5 1.16	30.5 1.20	1.0 0.04	44.5 1.75	7.6	7.1	0.0509	0.11 0.25
L44642	L44610	L44600LC	1	14.732 0.5800	-3.3 -0.13	3.5 0.14	29.5 1.16	36.0 1.42	1.3 0.05	44.5 1.75	8.9	8.9	0.0526	0.13 0.27
L44643	L44610	L44600LA	2	14.732 0.5800	-3.3 -0.13	1.3 0.05	30.0 1.18	32.0 1.26	1.3 0.05	44.5 1.75	8.9	8.9	0.0526	0.13 0.28
L44643X	L44610	L44600LB	2	14.732 0.5800	-3.3 -0.13	1.3 0.05	29.5 1.16	31.8 1.25	1.3 0.05	44.5 1.75	8.9	8.9	0.0526	0.13 0.28
LM67048	LM67010	LM67000LA	1	16.764 0.6600	-3 -0.12	3.5 0.14	36.0 1.42	42.5 1.67	1.3 0.05	52.0 2.05	12.8	9.7	0.0612	0.18 0.39
LM48548	LM48510	LM48500LA	1	18.288 0.7200	-3.6 -0.14	3.5 0.14	41.5 1.63	48.0 1.89	1.3 0.05	58.0 2.28	18.0	10.6	0.0666	0.25 0.54
LM29748	LM29710	LM29700LA	1	18.288 0.7200	-4.1 -0.16	3.5 0.14	42.5 1.67	49.0 1.93	1.3 0.05	58.9 2.32	20.4	15.0	0.0666	0.23 0.50
13685	13621A	13600LA	1	19.050 0.7500	-3 -0.12	3.5 0.14	43.0 1.69	49.5 1.95	2.3 0.09	61.0 2.40	20.7	12.2	0.0713	0.27 0.60
13685	13621	13600LA	1	19.050 0.7500	-3 -0.12	3.5 0.14	43.0 1.69	49.5 1.95	2.3 0.09	61.0 2.40	20.7	12.2	0.0713	0.28 0.62
390A	394A	395LC	1	21.996 0.8660	-0.8 -0.03	1.5 0.06	70.0 2.76	73.0 2.87	1.3 0.05	101.0 3.98	56.0	21.4	0.0984	0.84 1.84
399A	394A	395LA	1	21.996 0.8660	-0.8 -0.03	2.3 0.09	74.0 2.91	78.0 3.07	1.3 0.05	101.0 3.98	56.0	21.4	0.0984	0.75 1.65

<sup>(4)</sup>Negative value indicates effective center inside cone (inner-ring) backface.

<sup>(5)</sup>These maximum fillet radii will be cleared by the bearing corners.



**TYPE TDO**

- TDO consists of a single-piece (double) outer ring and two single inner rings.
- This configuration offers a wide effective bearing spread to support loads created by overturning moments.
- These bearings can be used at fixed positions or allowed to float in the housing bore to compensate for shaft expansion.



**DOUBLE-OUTER RING CONFIGURATIONS**

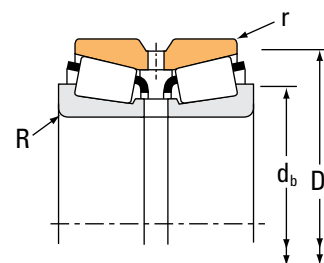
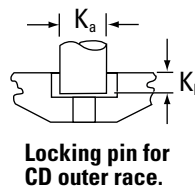
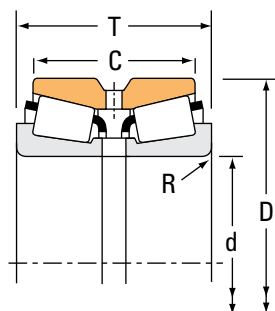
<b>D</b>	D suffix has a groove with oil holes for lubrication through the outer ring.
<b>CD</b>	CD suffix now replaces the DC suffix listed for part numbers in previous publications. Same features as D suffix, but CD also has groove with oil holes. One lubrication hole is counterbored to accept an anti-rotational pin. Default configuration for most series.

- TDO bearings are usually supplied complete with an inner-ring spacer as a pre-set assembly.
- To suit the application duty, the built-in setting value needs to be established by your Timken engineer before an order is placed.
- For spacer configuration information, contact your Timken engineer.
- Double outer ring can be used with any single inner ring from the same series.
- The tables list regularly specified inner-ring part numbers.
- Consult your Timken engineer before making a final bearing selection to help ensure suitability, availability and the most cost-effective solution.

# TAPERED ROLLER BEARINGS

## DOUBLE-ROW • TYPE TDO

### TYPE TDO



Bearing Dimensions				Load Ratings							
Bore d	O.D. D	Width T	Double Outer Ring Width C	Dynamic <sup>(1)</sup>		Factors <sup>(2)</sup>		Dynamic <sup>(3)</sup>			Factors <sup>(2)</sup>
				C <sub>1(2)</sub>	e	Y <sub>1</sub>	Y <sub>2</sub>	C <sub>90</sub>	C <sub>a90</sub>	C <sub>90(2)</sub>	K
mm in.	mm in.	mm in.	mm in.	N lbf				N lbf	N lbf	N lbf	
11.987 0.4719	30.480 1.2000	25.400 1.0000	21.260 0.8370	18800 4230	0.41	1.67	2.48	2800 630	1940 437	4880 1100	1.44
14.989 0.5901	34.988 1.3775	25.174 0.9911	20.638 0.8125	22900 5150	0.45	1.49	2.22	3410 767	2640 594	5940 1330	1.29
16.993 0.6690	47.000 1.8504	31.750 1.2500	25.212 0.9926	46500 10500	0.36	1.89	2.82	6930 1560	4230 952	12100 2710	1.64
19.050 0.7500	47.000 1.8504	31.750 1.2500	25.212 0.9926	46500 10500	0.36	1.89	2.82	6930 1560	4230 952	12100 2710	1.64
19.050 0.7500	57.150 2.2500	49.212 1.9375	36.512 1.4375	95900 21600	0.59	1.14	1.70	14300 3210	14400 3250	24900 5590	0.99
19.987 0.7869	47.000 1.8504	31.750 1.2500	25.212 0.9926	46500 10500	0.36	1.89	2.82	6930 1560	4230 952	12100 2710	1.64
20.000 0.7874	50.005 1.9687	33.340 1.3126	25.400 1.0000	50700 11400	0.40	1.68	2.50	7550 1700	5190 1170	13100 2950	1.45
24.384 0.9600	80.962 3.1875	55.562 2.1875	39.688 1.5625	160000 36000	0.67	1.01	1.50	23900 5360	27300 6130	41500 9340	0.87
24.981 0.9835	50.005 1.9687	33.340 1.3126	25.400 1.0000	50700 11400	0.40	1.68	2.50	7550 1700	5190 1170	13100 2950	1.45
24.981 0.9835	62.000 2.4409	39.688 1.5625	36.258 1.4275	75300 16900	0.38	1.77	2.63	11200 2520	7340 1650	19500 4390	1.53
25.000 0.9843	50.005 1.9687	33.340 1.3126	25.400 1.0000	50700 11400	0.40	1.68	2.50	7550 1700	5190 1170	13100 2950	1.45
25.000 0.9843	62.000 2.4409	39.688 1.5625	36.258 1.4275	75300 16900	0.38	1.77	2.63	11200 2520	7340 1650	19500 4390	1.53
25.400 1.0000	50.005 1.9687	33.340 1.3126	25.400 1.0000	50700 11400	0.40	1.68	2.50	7550 1700	5190 1170	13100 2950	1.45
25.400 1.0000	50.005 1.9687	33.340 1.3126	25.400 1.0000	50700 11400	0.40	1.68	2.50	7550 1700	5190 1170	13100 2950	1.45
25.400 1.0000	63.500 2.5000	46.038 1.8125	36.512 1.4375	104000 23400	0.35	1.93	2.87	15500 3490	9310 2090	27000 6080	1.67
25.400 1.0000	63.500 2.5000	46.038 1.8125	36.512 1.4375	104000 23400	0.35	1.93	2.87	15500 3490	9310 2090	27000 6080	1.67
25.400 1.0000	71.438 2.8125	42.862 1.6875	36.512 1.4375	102000 23000	0.36	1.87	2.79	15200 3420	9390 2110	26500 5960	1.62

<sup>(1)</sup>Based on  $1 \times 10^6$  revolutions  $L_{10}$  life, for the ISO life-calculation method.  $C_{1(2)}$  is the double-row radial value.

<sup>(2)</sup>Consult your Timken engineer for instructions on use or review the Timken Engineering Manual on [timken.com/catalogs](http://timken.com/catalogs).

<sup>(3)</sup>Based on  $90 \times 10^6$  revolutions  $L_{10}$  life, for The Timken Company life-calculation method.  $C_{90}$  and  $C_{a90}$  are radial and thrust values for a single row.  $C_{90(2)}$  is the double-row radial value.



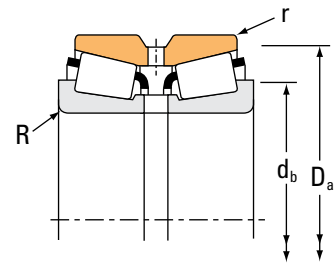
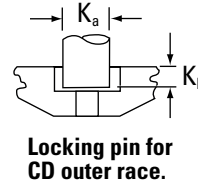
Part Number		Dimensions						Geometry Factors			Bearing Weight
Inner	Outer	Shaft		Housing		Pin		G <sub>1</sub>	G <sub>2</sub>	C <sub>g</sub>	
		Max. Shaft Fillet Radius R <sup>(4)</sup>	Backing Shoulder Dia. d <sub>b</sub>	Max. Housing Fillet Radius r <sup>(4)</sup>	Backing Shoulder Dia. D <sub>a</sub>	K <sub>a</sub>	K <sub>b</sub>				
		mm in.	mm in.	mm in.	mm in.	mm in.	mm in.				kg lbs.
A2047	A2120D	0.8 0.03	16.5 0.65	0.4 0.02	28.0 1.10	– –	– –	1.7	3.2	0.0308	0.09 0.19
A4059	A4138D	0.8 0.03	19.5 0.77	0.6 0.03	31.5 1.24	– –	– –	2.3	4.1	0.0355	0.11 0.26
05066	05185D	1.5 0.06	24.5 0.96	0.8 0.03	42.5 1.67	– –	– –	5.8	5.5	0.0448	0.29 0.62
05075	05185D	1.3 0.05	25.0 0.98	0.8 0.03	42.5 1.67	– –	– –	5.8	5.5	0.0448	0.27 0.59
21075	21226D	1.5 0.06	31.5 1.24	0.8 0.03	51.0 2.01	– –	– –	7.0	4.1	0.0558	0.65 1.44
05079	05185D	1.5 0.06	26.5 1.04	0.8 0.03	42.5 1.67	– –	– –	5.8	5.5	0.0448	0.27 0.57
07079	07196D	1.5 0.06	27.5 1.08	0.6 0.03	46.5 1.83	– –	– –	7.6	7.1	0.0509	0.31 0.70
43096	43319D	0.8 0.03	40.5 1.59	1.5 0.06	74.0 2.91	– –	– –	16.8	7.6	0.0774	1.43 3.14
07098	07196D	1.5 0.06	31.0 1.22	0.6 0.03	46.5 1.83	– –	– –	7.6	7.1	0.0509	0.27 0.61
17098	17245D	1.5 0.06	33.0 1.30	0.8 0.03	57.0 2.24	– –	– –	11.8	7.5	0.0579	0.60 1.33
07097	07196D	1.5 0.06	31.0 1.22	0.6 0.03	46.5 1.83	– –	– –	7.6	7.1	0.0509	0.27 0.61
17098X	17245D	1.5 0.06	33.0 1.30	0.8 0.03	57.0 2.24	– –	– –	11.8	7.5	0.0579	0.60 1.33
07100-S	07196D	1.5 0.06	31.5 1.24	0.6 0.03	46.5 1.83	– –	– –	7.6	7.1	0.0509	0.27 0.60
07100-SA	07196D	3.3 0.13	35.0 1.38	0.6 0.03	46.5 1.83	– –	– –	7.6	7.1	0.0509	0.27 0.59
15101	15251D	0.8 0.03	32.5 1.28	0.8 0.03	59.0 2.32	– –	– –	14.6	10.0	0.0606	0.73 1.59
15100-S	15251D	1.3 0.05	33.5 1.32	0.8 0.03	59.0 2.32	– –	– –	14.6	10.0	0.0606	0.73 1.59
26100	26282D	1.5 0.06	34.5 1.36	0.4 0.02	65.0 2.56	– –	– –	16.1	10.1	0.0630	0.89 1.96

<sup>(4)</sup>These maximum fillet radii will be cleared by bearing corners.  
NOTE: For spacer configuration information, contact your Timken engineer.

# TAPERED ROLLER BEARINGS

## DOUBLE-ROW • TYPE TDO

### TYPE TDO



Bearing Dimensions				Load Ratings							
Bore d	O.D. D	Width T	Double Outer Ring Width C	Dynamic <sup>(1)</sup>				Dynamic <sup>(3)</sup>			
				C <sub>1(2)</sub>	e	Y <sub>1</sub>	Y <sub>2</sub>	C <sub>90</sub>	C <sub>a90</sub>	C <sub>90(2)</sub>	K
mm in.	mm in.	mm in.	mm in.	N lbf				N lbf	N lbf	N lbf	
28.575 1.1250	63.500 2.5000	46.038 1.8125	36.512 1.4375	104000 23400	0.35	1.93	2.87	15500 3490	9310 2090	27000 6080	1.67
28.575 1.1250	76.200 3.0000	47.625 1.8750	38.100 1.5000	114000 25700	0.45	1.49	2.21	17000 3830	13200 2980	29700 6670	1.29
28.575 1.1250	80.962 3.1875	55.562 2.1875	39.688 1.5625	160000 36000	0.67	1.01	1.50	23900 5360	27300 6130	41500 9340	0.87
29.987 1.1806	62.000 2.4409	39.688 1.5625	36.258 1.4275	75300 16900	0.38	1.77	2.63	11200 2520	7340 1650	19500 4390	1.53
29.987 1.1806	63.500 2.5000	46.038 1.8125	36.512 1.4375	104000 23400	0.35	1.93	2.87	15500 3490	9310 2090	27000 6080	1.67
29.987 1.1806	71.438 2.8125	42.862 1.6875	36.512 1.4375	121000 27300	0.36	1.87	2.79	18100 4060	11100 2500	31400 7070	1.62
29.987 1.1806	71.973 2.8336	42.760 1.6835	36.512 1.4375	121000 27300	0.36	1.87	2.79	18100 4060	11100 2500	31400 7070	1.62
30.000 1.1811	69.012 2.7170	46.040 1.8126	38.100 1.5000	95100 21400	0.38	1.77	2.63	14200 3180	9260 2080	24600 5540	1.53
30.000 1.1811	69.012 2.7170	46.040 1.8126	38.100 1.5000	95100 21400	0.38	1.77	2.63	14200 3180	9260 2080	24600 5540	1.53
30.162 1.1875	58.738 2.3125	32.542 1.2812	24.608 0.9688	55200 12400	0.47	1.42	2.12	8220 1850	6670 1500	14300 3220	1.23
30.162 1.1875	62.000 2.4409	39.688 1.5625	36.258 1.4275	75300 16900	0.38	1.77	2.63	11200 2520	7340 1650	19500 4390	1.53
30.162 1.1875	66.421 2.6150	44.450 1.7500	38.100 1.5000	97300 21900	0.34	1.99	2.96	14500 3260	8420 1890	25200 5670	1.72
30.162 1.1875	80.962 3.1875	55.562 2.1875	39.688 1.5625	160000 36000	0.67	1.01	1.50	23900 5360	27300 6130	41500 9340	0.87
30.213 1.1895	63.500 2.5000	40.638 1.8125	36.512 1.4375	104000 23400	0.35	1.93	2.87	15500 3490	9310 2090	27000 6080	1.67
31.750 1.2500	58.738 2.3125	32.542 1.2812	24.608 0.9688	55200 12400	0.47	1.42	2.12	8220 1850	6670 1500	14300 3220	1.23
31.750 1.2500	63.500 2.5000	44.260 1.7425	36.512 1.4375	104000 23400	0.35	1.93	2.87	15500 3490	9310 2090	27000 6080	1.67
31.750 1.2500	63.500 2.5000	46.038 1.8125	36.512 1.4375	104000 23400	0.35	1.93	2.87	15500 3490	9310 2090	27000 6080	1.67

<sup>(1)</sup>Based on 1 x 10<sup>6</sup> revolutions L<sub>10</sub> life, for the ISO life-calculation method. C<sub>1(2)</sub> is the double-row radial value.

<sup>(2)</sup>Consult your Timken engineer for instructions on use or review the Timken Engineering Manual on [timken.com/catalogs](http://timken.com/catalogs).

<sup>(3)</sup>Based on 90 x 10<sup>6</sup> revolutions L<sub>10</sub> life, for The Timken Company life-calculation method. C<sub>90</sub> and C<sub>a90</sub> are radial and thrust values for a single row. C<sub>90(2)</sub> is the double-row radial value.

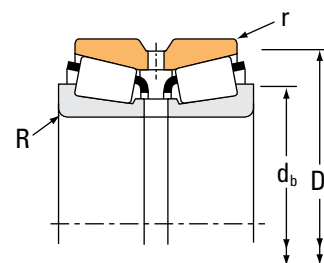
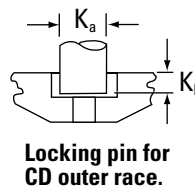
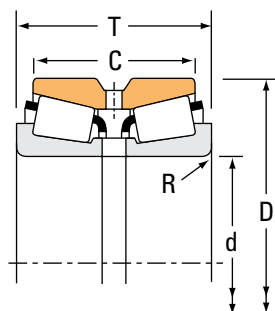
Part Number		Dimensions						Geometry Factors			Bearing Weight
Inner	Outer	Shaft		Housing		Pin		G <sub>1</sub>	G <sub>2</sub>	C <sub>G</sub>	
		Max. Shaft Fillet Radius R <sup>(4)</sup>	Backing Shoulder Dia. d <sub>b</sub>	Max. Housing Fillet Radius r <sup>(4)</sup>	Backing Shoulder Dia. D <sub>a</sub>	K <sub>a</sub>	K <sub>b</sub>				
		mm in.	mm in.	mm in.	mm in.	mm in.	mm in.				kg lbs.
15112	15251D	3.5 0.14	40.0 1.57	0.8 0.03	59.0 2.32	– –	– –	14.6	10.0	0.0606	0.66 1.45
02872	02823D	0.8 0.03	37.5 1.48	0.8 0.03	70.0 2.76	– –	– –	20.6	10.1	0.0740	1.13 2.49
43112	43319D	0.8 0.03	42.5 1.67	1.5 0.06	74.0 2.91	– –	– –	16.8	7.6	0.0774	1.37 3.01
17118	17245D	1.5 0.06	38.5 1.52	0.8 0.03	57.0 2.24	– –	– –	11.8	7.5	0.0579	0.53 1.18
15117	15251D	1.3 0.05	36.5 1.44	0.8 0.03	59.0 2.32	– –	– –	14.6	10.0	0.0606	0.66 1.43
26118	26282D	1.5 0.06	38.0 1.50	0.4 0.02	65.0 2.56	– –	– –	16.1	10.1	0.0630	0.83 1.83
26118	26284D	1.5 0.06	38.0 1.50	0.8 0.03	65.0 2.56	– –	– –	16.1	10.1	0.0630	0.84 1.85
14118	14276D	0.8 0.03	37.0 1.46	0.8 0.03	63.0 2.48	– –	– –	18.0	13.3	0.0668	0.78 1.75
14117A	14276D	3.5 0.14	44.0 1.73	0.8 0.03	63.0 2.48	– –	– –	18.0	13.3	0.0668	0.78 1.75
08118	08231D	3.5 0.14	41.5 1.63	0.4 0.02	55.0 2.17	– –	– –	10.7	10.6	0.0601	0.38 0.81
17119	17245D	1.5 0.06	37.0 1.46	0.8 0.03	57.0 2.24	– –	– –	11.8	7.5	0.0579	0.53 1.19
24118	24262D	1.5 0.06	37.5 1.48	0.8 0.03	61.0 2.40	– –	– –	14.0	8.3	0.0589	0.69 1.53
43118	43319D	1.5 0.06	45.0 1.77	1.5 0.06	74.0 2.91	– –	– –	16.8	7.6	0.0774	1.33 2.93
15119	15251D	1.5 0.06	37.5 1.48	0.8 0.03	59.0 2.32	– –	– –	14.6	10.0	0.0606	0.64 1.43
08125	08231D	1.0 0.04	37.5 1.48	0.4 0.02	55.0 2.17	– –	– –	10.7	10.6	0.0601	0.36 0.79
15123	15251D	3.5 0.14	44.0 1.73	0.8 0.03	59.0 2.32	– –	– –	14.6	10.0	0.0606	0.58 1.30
15125	15251D	3.5 0.14	42.5 1.67	0.8 0.03	59.0 2.32	– –	– –	14.6	10.0	0.0606	0.62 1.35

<sup>(4)</sup>These maximum fillet radii will be cleared by bearing corners.  
NOTE: For spacer configuration information, contact your Timken engineer.

# TAPERED ROLLER BEARINGS

## DOUBLE-ROW • TYPE TDO

### TYPE TDO



Bearing Dimensions				Load Ratings							
Bore d	O.D. D	Width T	Double Outer Ring Width C	Dynamic <sup>(1)</sup>				Dynamic <sup>(3)</sup>			
				C <sub>1(2)</sub>	e	Y <sub>1</sub>	Y <sub>2</sub>	C <sub>90</sub>	C <sub>a90</sub>	C <sub>90(2)</sub>	K
mm in.	mm in.	mm in.	mm in.	N lbf				N lbf	N lbf	N lbf	
31.750 1.2500	63.500 2.5000	46.038 1.8125	36.512 1.4375	104000 23400	0.35	1.93	2.87	15500 3490	9310 2090	27000 6080	1.67
31.750 1.2500	69.012 2.7170	46.040 1.8126	38.100 1.5000	95100 21400	0.38	1.77	2.63	14200 3180	9260 2080	24600 5540	1.53
31.750 1.2500	69.850 2.7500	66.675 2.6250	57.150 2.2500	146000 32800	0.27	2.47	3.67	21700 4880	10200 2280	37800 8500	2.14
31.750 1.2500	76.200 3.0000	47.625 1.8750	38.100 1.5000	114000 25700	0.45	1.49	2.21	17000 3830	13200 2980	29700 6670	1.29
31.750 1.2500	80.962 3.1875	55.562 2.1875	39.688 1.5625	160000 36000	0.67	1.01	1.50	23900 5360	27300 6130	41500 9340	0.87
31.750 1.2500	82.550 3.2500	66.678 2.6251	55.562 2.1875	182000 41000	0.37	1.85	2.75	27100 6100	17000 3820	47200 10600	1.60
33.338 1.3125	69.012 2.7170	46.040 1.8126	38.100 1.5000	95100 21400	0.38	1.77	2.63	14200 3180	9260 2080	24600 5540	1.53
33.337 1.3125	69.850 2.7500	66.675 2.6250	57.150 2.2500	146000 32800	0.27	2.47	3.67	21700 4880	10200 2280	37800 8500	2.14
33.337 1.3125	71.438 2.8125	42.862 1.6875	36.512 1.4375	121000 27300	0.36	1.87	2.79	18100 4060	11100 2500	31400 7070	1.62
33.337 1.3125	71.973 2.8336	42.760 1.6835	36.512 1.4375	121000 27300	0.36	1.87	2.79	18100 4060	11100 2500	31400 7070	1.62
33.337 1.3125	80.962 3.1875	55.562 2.1875	39.688 1.5625	160000 36000	0.67	1.01	1.50	23900 5360	27300 6130	41500 9340	0.87
33.337 1.3125	80.962 3.1875	55.563 2.1875	39.688 1.5625	160000 36000	0.67	1.01	1.50	23900 5360	27300 6130	41500 9340	0.87
34.925 1.3750	69.012 2.7170	46.040 1.8126	38.100 1.5000	95100 21400	0.38	1.77	2.63	14200 3180	9260 2080	24600 5540	1.53
34.925 1.3750	69.012 2.7170	46.040 1.8126	38.100 1.5000	95100 21400	0.38	1.77	2.63	14200 3180	9260 2080	24600 5540	1.53
34.925 1.3750	76.200 3.0000	47.625 1.8750	38.100 1.5000	114000 25700	0.45	1.49	2.21	17000 3830	13200 2980	29700 6670	1.29
34.925 1.3750	76.200 3.0000	47.625 1.8750	38.100 1.5000	114000 25700	0.45	1.49	2.21	17000 3830	13200 2980	29700 6670	1.29
34.925 1.3750	80.035 3.1510	46.040 1.8126	34.925 1.3750	131000 29500	0.40	1.68	2.50	19500 4390	13400 3020	34000 7640	1.45

<sup>(1)</sup>Based on  $1 \times 10^6$  revolutions  $L_{10}$  life, for the ISO life-calculation method.  $C_{1(2)}$  is the double-row radial value.

<sup>(2)</sup>Consult your Timken engineer for instructions on use or review the Timken Engineering Manual on [timken.com/catalogs](http://timken.com/catalogs).

<sup>(3)</sup>Based on  $90 \times 10^6$  revolutions  $L_{10}$  life, for The Timken Company life-calculation method.  $C_{90}$  and  $C_{a90}$  are radial and thrust values for a single row.  $C_{90(2)}$  is the double-row radial value.

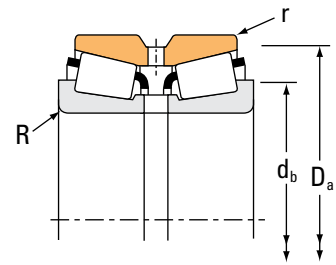
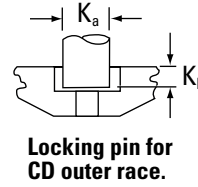
Part Number		Dimensions						Geometry Factors			Bearing Weight
Inner	Outer	Shaft		Housing		Pin		G <sub>1</sub>	G <sub>2</sub>	C <sub>G</sub>	
		Max. Shaft Fillet Radius R <sup>(4)</sup>	Backing Shoulder Dia. d <sub>b</sub>	Max. Housing Fillet Radius r <sup>(4)</sup>	Backing Shoulder Dia. D <sub>a</sub>	K <sub>a</sub>	K <sub>b</sub>				
		mm in.	mm in.	mm in.	mm in.	mm in.	mm in.				kg lbs.
15126	15251D	0.8 0.03	38.5 1.52	0.8 0.03	59.0 2.32	– –	– –	14.6	10.0	0.0606	0.62 1.37
14125A	14276D	3.5 0.14	45.0 1.77	0.8 0.03	63.0 2.48	– –	– –	18.0	13.3	0.0668	0.75 1.68
2580	2524YD	0.8 0.03	38.5 1.52	0.8 0.03	64.0 2.52	– –	– –	23.6	9.6	0.0656	1.18 2.61
02875	02823D	3.5 0.14	45.5 1.79	0.8 0.03	70.0 2.76	– –	– –	20.6	10.1	0.0740	1.07 2.35
43125	43319D	1.5 0.06	44.0 1.73	1.5 0.06	74.0 2.91	– –	– –	16.8	7.6	0.0774	1.31 2.88
3476	3423D	1.3 0.05	43.0 1.69	0.8 0.03	75.0 2.95	– –	– –	29.9	11.2	0.0781	1.84 4.05
14131	14276D	0.8 0.03	41.0 1.61	0.8 0.03	63.0 2.48	– –	– –	18.0	13.3	0.0668	0.73 1.63
2585	2523D	3.5 0.14	45.0 1.77	0.8 0.03	64.0 2.52	– –	– –	23.6	9.6	0.0656	1.15 2.51
26131	26282D	3.5 0.14	44.5 1.75	0.4 0.02	65.0 2.56	– –	– –	16.1	10.1	0.0630	0.76 1.67
26131	26284D	3.5 0.14	44.5 1.75	0.8 0.03	65.0 2.56	– –	– –	16.1	10.1	0.0630	0.78 1.71
43131	43319D	3.5 0.14	51.0 2.01	1.5 0.06	74.0 2.91	– –	– –	16.8	7.6	0.0774	1.27 2.78
43132	43319D	2.0 0.08	48.0 1.89	1.5 0.06	74.0 2.91	– –	– –	16.8	7.6	0.0774	1.27 2.80
14137A	14276D	1.5 0.06	43.5 1.71	0.8 0.03	63.0 2.48	– –	– –	18.0	13.3	0.0668	0.71 1.57
14138A	14276D	3.5 0.14	48.0 1.89	0.8 0.03	63.0 2.48	– –	– –	18.0	13.3	0.0668	0.71 1.56
02877	02823D	3.5 0.14	48.5 1.91	0.8 0.03	70.0 2.76	– –	– –	20.6	10.1	0.0740	1.01 2.21
02878	02823D	0.8 0.03	42.5 1.67	0.8 0.03	70.0 2.76	– –	– –	20.6	10.1	0.0740	1.01 2.24
28137	28318D	1.5 0.06	43.5 1.71	0.8 0.03	73.0 2.87	– –	– –	20.7	12.5	0.0709	1.05 2.31

<sup>(4)</sup>These maximum fillet radii will be cleared by bearing corners.  
NOTE: For spacer configuration information, contact your Timken engineer.

# TAPERED ROLLER BEARINGS

## DOUBLE-ROW • TYPE TDO

### TYPE TDO



Bearing Dimensions				Load Ratings							
Bore d	O.D. D	Width T	Double Outer Ring Width C	Dynamic <sup>(1)</sup>				Dynamic <sup>(3)</sup>			
				C <sub>1(2)</sub>	e	Y <sub>1</sub>	Y <sub>2</sub>	C <sub>90</sub>	C <sub>a90</sub>	C <sub>90(2)</sub>	K
mm in.	mm in.	mm in.	mm in.	N lbf				N lbf	N lbf	N lbf	
34.925 1.3750	80.035 3.1510	57.150 2.2500	44.958 1.7700	136000 30500	0.56	1.20	1.79	20200 4550	19400 4370	35200 7920	1.04
34.976 1.3770	69.012 2.7170	46.040 1.8126	38.100 1.5000	95100 21400	0.38	1.77	2.63	14200 3180	9260 2080	24600 5540	1.53
36.512 1.4375	82.550 3.2500	66.678 2.6251	55.562 2.1875	182000 41000	0.37	1.85	2.75	27100 6100	17000 3820	47200 10600	1.60
36.512 1.4375	82.931 3.2650	57.150 2.2500	47.625 1.8750	158000 35400	0.33	2.02	3.00	23500 5270	13500 3020	40900 9180	1.74
36.512 1.4375	92.075 3.6250	55.562 2.1875	39.688 1.5625	174000 39100	0.78	0.86	1.29	25900 5810	34600 7770	45000 10100	0.75
38.100 1.5000	63.500 2.5000	38.100 1.5000	31.750 1.2500	47300 10600	0.35	1.95	2.90	7040 1580	4170 938	12300 2760	1.69
38.100 1.5000	69.012 2.7170	46.035 1.8124	38.100 1.5000	117000 26300	0.40	1.68	2.50	17400 3920	12000 2700	30300 6820	1.45
38.100 1.5000	69.012 2.7170	46.035 1.8124	38.100 1.5000	117000 26300	0.40	1.68	2.50	17400 3920	12000 2700	30300 6820	1.45
38.100 1.5000	80.035 3.1510	46.040 1.8126	34.925 1.3750	131000 29500	0.40	1.68	2.50	19500 4390	13400 3020	34000 7640	1.45
38.100 1.5000	80.035 3.1510	57.150 2.2500	44.958 1.7700	136000 30500	0.56	1.20	1.79	20200 4550	19400 4370	35200 7920	1.04
38.100 1.5000	80.035 3.1510	57.150 2.2500	44.958 1.7700	136000 30500	0.56	1.20	1.79	20200 4550	19400 4370	35200 7920	1.04
38.100 1.5000	82.550 3.2500	66.678 2.6251	55.562 2.1875	182000 41000	0.37	1.85	2.75	27100 6100	17000 3820	47200 10600	1.60
38.100 1.5000	82.931 3.2650	57.150 2.2500	47.625 1.8750	158000 35400	0.33	2.02	3.00	23500 5270	13500 3020	40900 9180	1.74
38.100 1.5000	92.075 3.6250	55.562 2.1875	39.688 1.5625	174000 39100	0.78	0.86	1.29	25900 5810	34600 7770	45000 10100	0.75
38.100 1.5000	95.250 3.7500	63.500 2.5000	52.385 2.0624	226000 50800	0.33	2.05	3.05	33600 7560	19000 4270	58600 13200	1.77
38.100 1.5000	95.250 3.7500	65.090 2.5626	44.450 1.7500	207000 46500	0.74	0.91	1.36	30800 6920	39000 8760	53600 12000	0.79
38.100 1.5000	111.125 4.3750	79.375 3.1250	63.500 2.5000	300000 67400	0.30	2.28	3.39	44600 10000	22700 5090	77700 17500	1.97

<sup>(1)</sup>Based on  $1 \times 10^6$  revolutions  $L_{10}$  life, for the ISO life-calculation method.  $C_{1(2)}$  is the double-row radial value.

<sup>(2)</sup>Consult your Timken engineer for instructions on use or review the Timken Engineering Manual on [timken.com/catalogs](http://timken.com/catalogs).

<sup>(3)</sup>Based on  $90 \times 10^6$  revolutions  $L_{10}$  life, for The Timken Company life-calculation method.  $C_{90}$  and  $C_{a90}$  are radial and thrust values for a single row.  $C_{90(2)}$  is the double-row radial value.

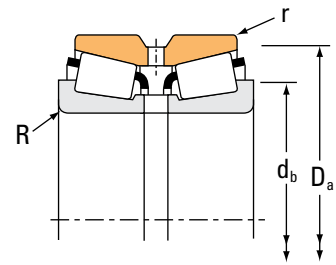
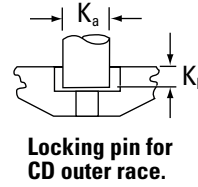
Part Number		Dimensions						Geometry Factors			Bearing Weight
Inner	Outer	Shaft		Housing		Pin		G <sub>1</sub>	G <sub>2</sub>	C <sub>G</sub>	
		Max. Shaft Fillet Radius R <sup>(4)</sup>	Backing Shoulder Dia. d <sub>b</sub>	Max. Housing Fillet Radius r <sup>(4)</sup>	Backing Shoulder Dia. D <sub>a</sub>	K <sub>a</sub>	K <sub>b</sub>				
		mm in.	mm in.	mm in.	mm in.	mm in.	mm in.				kg lbs.
27875	27820D	0.8 0.03	45.5 1.79	0.8 0.03	75.0 2.95	– –	– –	24.6	12.6	0.0839	1.32 2.93
14139	14276D	1.3 0.05	43.5 1.71	0.8 0.03	63.0 2.48	– –	– –	18.0	13.3	0.0668	0.71 1.57
3479	3423D	0.8 0.03	45.5 1.79	0.8 0.03	75.0 2.95	– –	– –	29.9	11.2	0.0781	1.71 3.77
25570	25520D	3.5 0.14	51.0 2.01	0.8 0.03	77.0 3.03	– –	– –	35.2	14.3	0.0801	1.53 3.36
44143	44363D	2.3 0.09	54.0 2.13	1.5 0.06	85.0 3.35	– –	– –	22.9	8.7	0.0899	1.72 3.78
13889	13835D	1.5 0.06	45.0 1.77	0.4 0.02	60.0 2.36	– –	– –	14.8	23.3	0.0601	0.32 0.70
13685	13621D	3.5 0.14	49.5 1.95	0.8 0.03	65.0 2.56	– –	– –	20.7	12.2	0.0713	0.66 1.45
13687	13621D	2.0 0.08	46.5 1.83	0.8 0.03	65.0 2.56	– –	– –	20.7	12.2	0.0713	0.66 1.46
28150	28318D	1.5 0.06	45.5 1.79	0.8 0.03	73.0 2.87	– –	– –	20.7	12.5	0.0709	0.98 2.16
27880	27820D	0.8 0.03	48.0 1.89	0.8 0.03	75.0 2.95	– –	– –	24.6	12.6	0.0839	1.22 2.69
27881	27820D	3.5 0.14	53.0 2.09	0.8 0.03	75.0 2.95	– –	– –	24.6	12.6	0.0839	1.20 2.66
3490	3423D	3.5 0.14	52.0 2.05	0.8 0.03	75.0 2.95	– –	– –	29.9	11.2	0.0781	1.65 3.64
25572	25520D	0.8 0.03	46.0 1.81	0.8 0.03	77.0 3.03	– –	– –	35.2	14.3	0.0801	1.49 3.26
44150	44363D	2.3 0.09	55.0 2.17	1.5 0.06	85.0 3.35	– –	– –	22.9	8.7	0.0899	1.67 3.69
33880	33821D	3.5 0.14	54.0 2.13	0.8 0.03	90.0 3.54	– –	– –	52.5	18.5	0.0910	2.26 4.97
53150	53376D	1.5 0.06	55.0 2.17	0.8 0.03	89.0 3.50	– –	– –	26.7	9.6	0.0930	2.08 4.62
542	533D	3.5 0.14	55.0 2.17	1.5 0.06	100.0 3.94	– –	– –	64.3	16.1	0.0938	4.04 8.88

<sup>(4)</sup>These maximum fillet radii will be cleared by bearing corners.  
NOTE: For spacer configuration information, contact your Timken engineer.

# TAPERED ROLLER BEARINGS

## DOUBLE-ROW • TYPE TDO

### TYPE TDO



Bearing Dimensions				Load Ratings							
Bore d	O.D. D	Width T	Double Outer Ring Width C	Dynamic <sup>(1)</sup>				Dynamic <sup>(3)</sup>			
				C <sub>1(2)</sub>	e	Y <sub>1</sub>	Y <sub>2</sub>	C <sub>90</sub>	C <sub>a90</sub>	C <sub>90(2)</sub>	K
mm in.	mm in.	mm in.	mm in.	N lbf				N lbf	N lbf	N lbf	
38.481 1.5150	63.500 2.5000	38.100 1.5000	31.750 1.2500	47300 10600	0.35	1.95	2.90	7040 1580	4170 938	12300 2760	1.69
39.687 1.5625	92.075 3.6250	55.562 2.1875	39.688 1.5625	174000 39100	0.78	0.86	1.29	25900 5810	34600 7770	45000 10100	0.75
39.980 1.5740	80.035 3.1510	46.040 1.8126	34.925 1.3750	111000 24800	0.40	1.68	2.50	16500 3700	11300 2550	28700 6440	1.45
40.000 1.5748	80.035 3.1510	46.040 1.8126	34.925 1.3750	131000 29500	0.40	1.68	2.50	19500 4390	13400 3020	34000 7640	1.45
40.000 1.5748	90.119 3.5480	50.800 2.0000	44.450 1.7500	169000 38000	0.31	2.20	3.28	25100 5650	13200 2960	43800 9840	1.91
40.000 1.5748	90.119 3.5480	50.800 2.0000	44.450 1.7500	169000 38000	0.31	2.20	3.28	25100 5650	13200 2960	43800 9840	1.91
41.275 1.6250	90.000 3.5433	50.010 1.9689	42.070 1.6563	177000 39900	0.32	2.11	3.14	26400 5930	14400 3250	46000 10300	1.83
41.275 1.6250	92.075 3.6250	55.562 2.1875	39.688 1.5625	174000 39100	0.78	0.86	1.29	25900 5810	34600 7770	45000 10100	0.75
41.275 1.6250	95.250 3.7500	61.915 2.4376	50.800 2.0000	221000 49700	0.28	2.37	3.53	32900 7400	16000 3600	57300 12900	2.05
41.275 1.6250	107.950 4.2500	65.090 2.5626	53.975 2.1250	236000 53100	0.34	2.01	3.00	35200 7900	20200 4540	61200 13800	1.74
42.862 1.6875	82.550 3.2500	44.450 1.7500	34.925 1.3750	135000 30300	0.43	1.57	2.34	20100 4510	14800 3320	35000 7860	1.36
42.862 1.6875	82.931 3.2650	57.150 2.2500	47.625 1.8750	158000 35400	0.33	2.02	3.00	23500 5270	13500 3020	40900 9180	1.74
44.450 1.7500	79.375 3.1250	41.272 1.6249	33.338 1.3125	90600 20400	0.37	1.80	2.69	13500 3030	8630 1940	23500 5280	1.56
44.450 1.7500	82.931 3.2650	57.150 2.2500	47.625 1.8750	158000 35400	0.33	2.02	3.00	23500 5270	13500 3020	40900 9180	1.74
44.450 1.7500	82.931 3.2650	57.150 2.2500	47.625 1.8750	158000 35400	0.33	2.02	3.00	23500 5270	13500 3020	40900 9180	1.74
44.450 1.7500	90.119 3.5480	50.800 2.0000	44.450 1.7500	169000 38000	0.31	2.20	3.28	25100 5650	13200 2960	43800 9840	1.91
44.450 1.7500	90.119 3.5480	50.800 2.0000	44.450 1.7500	169000 38000	0.31	2.20	3.28	25100 5650	13200 2960	43800 9840	1.91

<sup>(1)</sup>Based on  $1 \times 10^6$  revolutions  $L_{10}$  life, for the ISO life-calculation method.  $C_{1(2)}$  is the double-row radial value.

<sup>(2)</sup>Consult your Timken engineer for instructions on use or review the Timken Engineering Manual on [timken.com/catalogs](http://timken.com/catalogs).

<sup>(3)</sup>Based on  $90 \times 10^6$  revolutions  $L_{10}$  life, for The Timken Company life-calculation method.  $C_{90}$  and  $C_{a90}$  are radial and thrust values for a single row.  $C_{90(2)}$  is the double-row radial value.



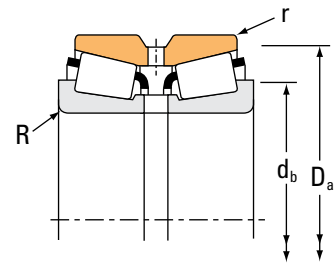
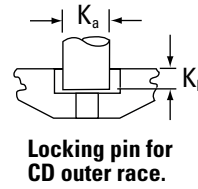
Part Number		Dimensions						Geometry Factors			Bearing Weight
Inner	Outer	Shaft		Housing		Pin		G <sub>1</sub>	G <sub>2</sub>	C <sub>G</sub>	
		Max. Shaft Fillet Radius R <sup>(4)</sup>	Backing Shoulder Dia. d <sub>b</sub>	Max. Housing Fillet Radius r <sup>(4)</sup>	Backing Shoulder Dia. D <sub>a</sub>	K <sub>a</sub>	K <sub>b</sub>				
		mm in.	mm in.	mm in.	mm in.	mm in.	mm in.				kg lbs.
13890	13835D	0.4 0.02	43.0 1.69	0.4 0.02	60.0 2.36	– –	– –	14.8	23.3	0.0601	0.41 0.91
44156	44363D	2.3 0.09	56.0 2.20	1.5 0.06	85.0 3.35	– –	– –	22.9	8.7	0.0899	1.63 3.62
28159	28318D	3.5 0.14	52.0 2.05	0.8 0.03	73.0 2.87	– –	– –	20.7	12.5	0.0709	0.93 2.07
28158	28318D	1.5 0.06	47.5 1.87	0.8 0.03	73.0 2.87	– –	– –	20.7	12.5	0.0709	0.94 2.07
357	353D	2.3 0.09	51.0 2.01	0.8 0.03	82.0 3.23	– –	– –	30.0	12.2	0.0732	1.53 3.37
350A	353D	0.8 0.03	47.5 1.87	0.8 0.03	82.0 3.23	– –	– –	30.0	12.2	0.0732	1.53 3.38
365A	363D	3.5 0.14	55.0 2.17	0.8 0.03	84.0 3.31	– –	– –	33.8	14.0	0.0773	1.40 3.11
44162	44363D	2.3 0.09	57.0 2.24	1.5 0.06	85.0 3.35	– –	– –	22.9	8.7	0.0899	1.59 3.53
447	432D	3.5 0.14	55.0 2.17	0.8 0.03	87.0 3.43	– –	– –	42.5	11.3	0.0805	2.10 4.65
464	452D	2.3 0.09	56.0 2.20	0.8 0.03	100.0 3.94	– –	– –	58.6	17.1	0.0946	3.06 6.77
22168	22325D	2.3 0.09	52.0 2.05	0.8 0.03	76.0 2.99	– –	– –	23.7	14.4	0.0758	1.01 2.24
25578	25520D	2.3 0.09	53.0 2.09	0.8 0.03	77.0 3.03	– –	– –	35.2	14.3	0.0801	1.48 3.28
18685	18620D	2.8 0.11	54.0 2.13	0.8 0.03	74.0 2.91	– –	– –	23.9	18.7	0.0725	0.78 1.70
25580	25520D	3.5 0.14	57.0 2.24	0.8 0.03	77.0 3.03	– –	– –	35.2	14.3	0.0801	1.31 2.87
25581	25520D	0.5 0.02	51.0 2.01	0.8 0.03	77.0 3.03	– –	– –	35.2	14.3	0.0801	1.31 2.92
355	353D	2.3 0.09	54.0 2.13	0.8 0.03	82.0 3.23	– –	– –	30.0	12.2	0.0732	1.40 3.08
355A	353D	0.8 0.03	51.0 2.01	0.8 0.03	82.0 3.23	– –	– –	30.0	12.2	0.0732	1.41 3.10

<sup>(4)</sup>These maximum fillet radii will be cleared by bearing corners.  
NOTE: For spacer configuration information, contact your Timken engineer.

# TAPERED ROLLER BEARINGS

## DOUBLE-ROW • TYPE TDO

### TYPE TDO



Bearing Dimensions				Load Ratings							
Bore d	O.D. D	Width T	Double Outer Ring Width C	Dynamic <sup>(1)</sup>		Factors <sup>(2)</sup>		Dynamic <sup>(3)</sup>			Factors <sup>(2)</sup>
				C <sub>1(2)</sub>	e	Y <sub>1</sub>	Y <sub>2</sub>	C <sub>90</sub>	C <sub>a90</sub>	C <sub>90(2)</sub>	K
mm in.	mm in.	mm in.	mm in.	N lbf				N lbf	N lbf	N lbf	
44.450 1.7500	93.264 3.6718	65.088 2.5625	52.388 2.0625	213000 47800	0.34	1.99	2.97	31700 7120	18300 4120	55100 12400	1.73
44.450 1.7500	95.250 3.7500	61.915 2.4376	50.800 2.0000	221000 49700	0.28	2.37	3.53	32900 7400	16000 3600	57300 12900	2.05
44.450 1.7500	95.250 3.7500	61.915 2.4376	50.800 2.0000	221000 49700	0.28	2.37	3.53	32900 7400	16000 3600	57300 12900	2.05
44.450 1.7500	95.250 3.7500	63.500 2.5000	52.385 2.0624	226000 50800	0.33	2.05	3.05	33600 7560	19000 4270	58600 13200	1.77
44.450 1.7500	95.250 3.7500	65.090 2.5626	44.450 1.7500	207000 46500	0.74	0.91	1.36	30800 6920	39000 8760	53600 12000	0.79
44.450 1.7500	95.250 3.7500	65.090 2.5626	44.450 1.7500	207000 46500	0.74	0.91	1.36	30800 6920	39000 8760	53600 12000	0.79
44.450 1.7500	98.425 3.8750	65.090 2.5626	44.450 1.7500	207000 46500	0.74	0.91	1.36	30800 6920	39000 8760	53600 12000	0.79
44.450 1.7500	107.950 4.2500	65.090 2.5626	53.975 2.1250	236000 53100	0.34	2.01	3.00	35200 7900	20200 4540	61200 13800	1.74
44.450 1.7500	112.712 4.4375	65.088 2.5625	46.038 1.8125	220000 49400	0.88	0.76	1.14	32700 7350	49500 11100	56900 12800	0.66
44.450 1.7500	112.712 4.4375	65.088 2.5625	46.038 1.8125	220000 49400	0.88	0.76	1.14	32700 7350	49500 11100	56900 12800	0.66
44.983 1.7710	82.931 3.2650	57.150 2.2500	47.625 1.8750	158000 35400	0.33	2.02	3.00	23500 5270	13500 3020	40900 9180	1.74
44.983 1.7710	93.264 3.6718	65.088 2.5625	52.388 2.0625	213000 47800	0.34	1.99	2.97	31700 7120	18300 4120	55100 12400	1.73
45.000 1.7717	85.000 3.3465	50.750 1.9980	40.000 1.5748	181000 40600	0.40	1.67	2.48	26900 6050	18700 4190	46800 10500	1.44
45.000 1.7717	90.000 3.5433	50.010 1.9689	42.070 1.6563	177000 39900	0.32	2.11	3.14	26400 5930	14400 3250	46000 10300	1.83
45.000 1.7717	90.119 3.5480	50.800 2.0000	44.450 1.7500	169000 38000	0.31	2.20	3.28	25100 5650	13200 2960	43800 9840	1.91
45.000 1.7717	90.119 3.5480	50.800 2.0000	44.450 1.7500	142000 32000	0.31	2.20	3.28	21200 4770	11100 2500	36900 8310	1.91
45.618 1.7960	82.931 3.2650	57.150 2.2500	47.625 1.8750	158000 35400	0.33	2.02	3.00	23500 5270	13500 3020	40900 9180	1.74

<sup>(1)</sup>Based on 1 x 10<sup>6</sup> revolutions L<sub>10</sub> life, for the ISO life-calculation method. C<sub>1(2)</sub> is the double-row radial value.

<sup>(2)</sup>Consult your Timken engineer for instructions on use or review the Timken Engineering Manual on [timken.com/catalogs](http://timken.com/catalogs).

<sup>(3)</sup>Based on 90 x 10<sup>6</sup> revolutions L<sub>10</sub> life, for The Timken Company life-calculation method. C<sub>90</sub> and C<sub>a90</sub> are radial and thrust values for a single row. C<sub>90(2)</sub> is the double-row radial value.

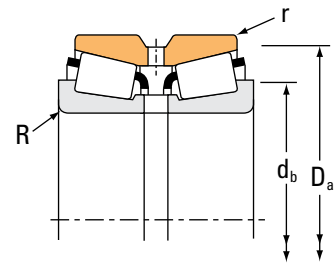
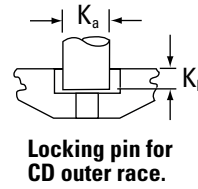
Part Number		Dimensions						Geometry Factors			Bearing Weight
Inner	Outer	Shaft		Housing		Pin		G <sub>1</sub>	G <sub>2</sub>	C <sub>g</sub>	
		Max. Shaft Fillet Radius R <sup>(4)</sup>	Backing Shoulder Dia. d <sub>b</sub>	Max. Housing Fillet Radius r <sup>(4)</sup>	Backing Shoulder Dia. D <sub>a</sub>	K <sub>a</sub>	K <sub>b</sub>				
		mm in.	mm in.	mm in.	mm in.	mm in.	mm in.				kg lbs.
3782	3729D	3.5 0.14	58.0 2.28	0.8 0.03	87.9 3.46	– –	– –	49.9	14.5	0.0903	2.07 4.53
435	432D	0.8 0.03	52.0 2.05	0.8 0.03	87.0 3.43	– –	– –	42.5	11.3	0.0805	2.01 4.44
438	432D	3.5 0.14	57.0 2.24	0.8 0.03	87.0 3.43	– –	– –	42.5	11.3	0.0805	1.99 4.41
33885	33821D	0.8 0.03	53.0 2.09	0.8 0.03	90.0 3.54	– –	– –	52.5	18.5	0.0910	2.11 4.66
53177	53376D	3.5 0.14	63.0 2.48	0.8 0.03	89.0 3.50	– –	– –	26.7	9.6	0.0930	1.89 4.15
53178	53376D	2.0 0.08	60.0 2.36	0.8 0.03	89.0 3.50	– –	– –	26.7	9.6	0.0930	1.89 4.18
53177	53390D	3.5 0.14	63.0 2.48	1.5 0.06	90.0 3.54	– –	– –	26.7	9.6	0.0930	2.07 4.56
458	452D	0.8 0.03	55.0 2.17	0.8 0.03	100.0 3.94	– –	– –	58.6	17.1	0.0946	2.99 6.56
55175	55444D	3.5 0.14	67.0 2.64	1.5 0.06	105.0 4.13	– –	– –	36.8	13.2	0.1085	3.02 6.67
55176	55444D	0.8 0.03	61.0 2.40	1.5 0.06	105.0 4.13	– –	– –	36.8	13.2	0.1085	3.04 6.70
25584	25520D	1.5 0.06	53.0 2.09	0.8 0.03	77.0 3.03	– –	– –	35.2	14.3	0.0801	1.31 2.87
3776	3729D	3.5 0.14	59.0 2.32	0.8 0.03	87.9 3.46	– –	– –	49.9	14.5	0.0903	2.04 4.47
X32209	32209AD	1.5 0.06	54.0 2.13	0.8 0.03	81.0 3.19	– –	– –	30.5	13.8	0.0809	0.80 1.76
367	363D	2.0 0.08	55.0 2.17	0.8 0.03	84.0 3.31	– –	– –	33.8	14.0	0.0773	1.33 2.93
358	353D	1.5 0.06	53.0 2.09	0.8 0.03	82.0 3.23	– –	– –	30.0	12.2	0.0732	1.38 3.05
358A	353D	3.5 0.14	57.0 2.24	0.8 0.03	82.0 3.23	– –	– –	30.0	12.2	0.0732	1.39 3.04
25590	25520D	3.5 0.14	58.0 2.28	0.8 0.03	77.0 3.03	– –	– –	35.2	14.3	0.0801	1.27 2.80

<sup>(4)</sup>These maximum fillet radii will be cleared by bearing corners.  
NOTE: For spacer configuration information, contact your Timken engineer.

# TAPERED ROLLER BEARINGS

## DOUBLE-ROW • TYPE TDO

### TYPE TDO



Bearing Dimensions				Load Ratings							
Bore d	O.D. D	Width T	Double Outer Ring Width C	Dynamic <sup>(1)</sup>				Dynamic <sup>(3)</sup>			
				C <sub>1(2)</sub>	e	Y <sub>1</sub>	Y <sub>2</sub>	C <sub>90</sub>	C <sub>a90</sub>	C <sub>90(2)</sub>	K
mm in.	mm in.	mm in.	mm in.	N lbf				N lbf	N lbf	N lbf	
46.037 1.8125	79.375 3.1250	41.272 1.6249	33.338 1.3125	90600 20400	0.37	1.80	2.69	13500 3030	8630 1940	23500 5280	1.56
46.037 1.8125	90.119 3.5480	50.800 2.0000	44.450 1.7500	169000 38000	0.31	2.20	3.28	25100 5650	13200 2960	43800 9840	1.91
46.037 1.8125	95.250 3.7500	61.915 2.4376	50.800 2.0000	221000 49700	0.28	2.37	3.53	32900 7400	16000 3600	57300 12900	2.05
47.625 1.8750	90.000 3.5433	50.010 1.9689	42.070 1.6563	177000 39900	0.32	2.11	3.14	26400 5930	14400 3250	46000 10300	1.83
47.625 1.8750	90.000 3.5433	50.010 1.9689	42.070 1.6563	177000 39900	0.32	2.11	3.14	26400 5930	14400 3250	46000 10300	1.83
47.625 1.8750	93.264 3.6718	65.088 2.5625	52.388 2.0625	213000 47800	0.34	1.99	2.97	31700 7120	18300 4120	55100 12400	1.73
47.625 1.8750	100.000 3.9370	49.200 1.9370	39.675 1.5620	188000 42200	0.35	1.91	2.84	28000 6280	16900 3810	48700 10900	1.65
47.625 1.8750	100.000 3.9370	52.388 2.0625	42.862 1.6875	188000 42200	0.35	1.91	2.84	28000 6280	16900 3810	48700 10900	1.65
47.625 1.8750	107.950 4.2500	65.090 2.5626	53.975 2.1250	280000 62900	0.34	2.01	3.00	41700 9370	23900 5380	72600 16300	1.74
47.625 1.8750	109.982 4.3300	63.500 2.5000	42.865 1.6876	220000 49400	0.88	0.76	1.14	32700 7350	49500 11100	56900 12800	0.66
47.625 1.8750	112.712 4.4375	65.088 2.5625	46.038 1.8125	220000 49400	0.88	0.76	1.14	32700 7350	49500 11100	56900 12800	0.66
47.625 1.8750	117.475 4.6250	73.025 2.8750	53.975 2.1250	307000 69100	0.63	1.08	1.60	45800 10300	49100 11000	79700 17900	0.93
49.212 1.9375	93.264 3.6718	65.088 2.5625	52.388 2.0625	213000 47800	0.34	1.99	2.97	31700 7120	18300 4120	55100 12400	1.73
49.974 1.9675	109.982 4.3300	63.500 2.5000	42.865 1.6876	220000 49400	0.88	0.76	1.14	32700 7350	49500 11100	56900 12800	0.66
49.974 1.9675	112.712 4.4375	65.088 2.5625	46.038 1.8125	220000 49400	0.88	0.76	1.14	32700 7350	49500 11100	56900 12800	0.66
50.000 1.9685	90.000 3.5433	50.010 1.9689	42.070 1.6563	177000 39900	0.32	2.11	3.14	26400 5930	14400 3250	46000 10300	1.83
50.000 1.9685	90.000 3.5433	50.010 1.9689	42.070 1.6563	177000 39900	0.32	2.11	3.14	26400 5930	14400 3250	46000 10300	1.83

<sup>(1)</sup>Based on 1 x 10<sup>6</sup> revolutions L<sub>10</sub> life, for the ISO life-calculation method. C<sub>1(2)</sub> is the double-row radial value.

<sup>(2)</sup>Consult your Timken engineer for instructions on use or review the Timken Engineering Manual on [timken.com/catalogs](http://timken.com/catalogs).

<sup>(3)</sup>Based on 90 x 10<sup>6</sup> revolutions L<sub>10</sub> life, for The Timken Company life-calculation method. C<sub>90</sub> and C<sub>a90</sub> are radial and thrust values for a single row. C<sub>90(2)</sub> is the double-row radial value.

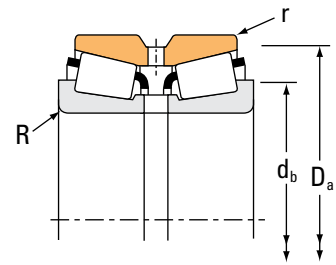
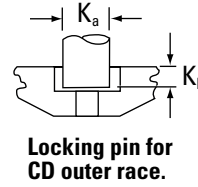
Part Number		Dimensions						Geometry Factors			Bearing Weight
Inner	Outer	Shaft		Housing		Pin		G <sub>1</sub>	G <sub>2</sub>	C <sub>G</sub>	
		Max. Shaft Fillet Radius R <sup>(4)</sup>	Backing Shoulder Dia. d <sub>b</sub>	Max. Housing Fillet Radius r <sup>(4)</sup>	Backing Shoulder Dia. D <sub>a</sub>	K <sub>a</sub>	K <sub>b</sub>				
		mm in.	mm in.	mm in.	mm in.	mm in.	mm in.				kg lbs.
18690	18620D	2.8 0.11	56.0 2.20	0.8 0.03	74.0 2.91	– –	– –	23.9	18.7	0.0725	0.74 1.64
359-S	353D	2.3 0.09	55.0 2.17	0.8 0.03	82.0 3.23	– –	– –	30.0	12.2	0.0732	1.37 2.99
436	432D	3.5 0.14	59.0 2.32	0.8 0.03	87.0 3.43	– –	– –	42.5	11.3	0.0805	1.95 4.29
369A	363D	3.5 0.14	60.0 2.36	0.8 0.03	84.0 3.31	– –	– –	33.8	14.0	0.0773	1.27 2.78
369-S	363D	2.3 0.09	57.0 2.24	0.8 0.03	84.0 3.31	– –	– –	33.8	14.0	0.0773	1.27 2.79
3779	3729D	3.5 0.14	61.0 2.40	0.8 0.03	87.9 3.46	– –	– –	49.9	14.5	0.0903	1.94 4.27
386A	384ED	0.8 0.03	56.0 2.20	0.8 0.03	93.0 3.66	– –	– –	42.0	15.7	0.0859	1.73 3.78
386A	384D	0.8 0.03	56.0 2.20	0.8 0.03	93.0 3.66	– –	– –	42.0	15.7	0.0859	1.78 3.91
467	452D	0.8 0.03	57.0 2.24	0.8 0.03	100.0 3.94	– –	– –	58.6	17.1	0.0946	2.87 6.35
55187	55433D	3.5 0.14	69.0 2.72	0.5 0.02	105.0 4.13	– –	– –	36.8	13.2	0.1085	2.76 6.11
55187	55444D	3.5 0.14	69.0 2.72	1.5 0.06	105.0 4.13	– –	– –	36.8	13.2	0.1085	2.90 6.41
66187	66462D	3.5 0.14	69.0 2.72	0.8 0.03	111.0 4.37	– –	– –	50.2	16.4	0.0751	3.77 8.31
3781	3729D	3.5 0.14	62.0 2.44	0.8 0.03	87.9 3.46	– –	– –	49.9	14.5	0.0903	1.88 4.14
55197	55433D	2.0 0.08	68.0 2.68	0.5 0.02	105.0 4.13	– –	– –	36.8	13.2	0.1085	2.69 5.93
55197	55444D	2.0 0.08	68.0 2.68	1.5 0.06	105.0 4.13	– –	– –	36.8	13.2	0.1085	2.83 6.24
365	363D	2.0 0.08	58.0 2.28	0.8 0.03	84.0 3.31	– –	– –	33.8	14.0	0.0773	1.21 2.64
366	363D	2.3 0.09	59.0 2.32	0.8 0.03	84.0 3.31	– –	– –	33.8	14.0	0.0773	1.20 2.62

<sup>(4)</sup>These maximum fillet radii will be cleared by bearing corners.  
NOTE: For spacer configuration information, contact your Timken engineer.

# TAPERED ROLLER BEARINGS

## DOUBLE-ROW • TYPE TDO

### TYPE TDO



Bearing Dimensions				Load Ratings							
Bore d	O.D. D	Width T	Double Outer Ring Width C	Dynamic <sup>(1)</sup>				Dynamic <sup>(3)</sup>			
				C <sub>1(2)</sub>	e	Y <sub>1</sub>	Y <sub>2</sub>	C <sub>90</sub>	C <sub>a90</sub>	C <sub>90(2)</sub>	K
mm in.	mm in.	mm in.	mm in.	N lbf				N lbf	N lbf	N lbf	
50.000 1.9685	107.950 4.2500	65.090 2.5626	53.975 2.1250	280000 62900	0.34	2.01	3.00	41700 9370	23900 5380	72600 16300	1.74
50.000 1.9685	110.000 4.3307	52.388 2.0625	46.038 1.8125	172000 38700	0.40	1.68	2.50	25600 5760	17600 3970	44600 10000	1.45
50.800 2.0000	80.962 3.1875	42.865 1.6876	34.925 1.3750	106000 23800	0.36	1.90	2.83	15800 3540	9590 2160	27400 6170	1.64
50.800 2.0000	89.985 3.5427	50.400 1.9843	49.950 1.9665	177000 39900	0.32	2.11	3.14	26400 5930	14400 3250	46000 10300	1.83
50.800 2.0000	90.000 3.5433	50.010 1.9689	42.070 1.6563	177000 39900	0.32	2.11	3.14	26400 5930	14400 3250	46000 10300	1.83
50.800 2.0000	90.000 3.5433	50.010 1.9689	42.070 1.6563	177000 39900	0.32	2.11	3.14	26400 5930	14400 3250	46000 10300	1.83
50.800 2.0000	93.264 3.6718	65.088 2.5625	52.388 2.0625	213000 47800	0.34	1.99	2.97	31700 7120	18300 4120	55100 12400	1.73
50.800 2.0000	93.264 3.6718	65.088 2.5625	52.388 2.0625	213000 47800	0.34	1.99	2.97	31700 7120	18300 4120	55100 12400	1.73
50.800 2.0000	93.264 3.6718	65.088 2.5625	52.388 2.0625	213000 47800	0.34	1.99	2.97	31700 7120	18300 4120	55100 12400	1.73
50.800 2.0000	95.250 3.7500	63.500 2.5000	52.385 2.0624	226000 50800	0.33	2.05	3.05	33600 7560	19000 4270	58600 13200	1.77
50.800 2.0000	100.000 3.9370	49.200 1.9370	39.675 1.5620	188000 42200	0.35	1.91	2.84	28000 6280	16900 3810	48700 10900	1.65
50.800 2.0000	100.000 3.9370	52.388 2.0625	42.862 1.6875	188000 42200	0.35	1.91	2.84	28000 6280	16900 3810	48700 10900	1.65
50.800 2.0000	100.000 3.9370	52.388 2.0625	42.862 1.6875	188000 42200	0.35	1.91	2.84	28000 6280	16900 3810	48700 10900	1.65
50.800 2.0000	107.950 4.2500	65.090 2.5626	53.975 2.1250	280000 62900	0.34	2.01	3.00	41700 9370	23900 5380	72600 16300	1.74
50.800 2.0000	107.950 4.2500	65.090 2.5626	53.975 2.1250	280000 62900	0.34	2.01	3.00	41700 9370	23900 5380	72600 16300	1.74
50.800 2.0000	109.982 4.3300	63.500 2.5000	42.865 1.6876	220000 49400	0.88	0.76	1.14	32700 7350	49500 11100	56900 12800	0.66
50.800 2.0000	109.982 4.3300	63.500 2.5000	42.865 1.6876	263000 59200	0.88	0.76	1.14	39200 8810	59300 13300	68200 15300	0.66

<sup>(1)</sup>Based on 1 x 10<sup>6</sup> revolutions L<sub>10</sub> life, for the ISO life-calculation method. C<sub>1(2)</sub> is the double-row radial value.

<sup>(2)</sup>Consult your Timken engineer for instructions on use or review the Timken Engineering Manual on [timken.com/catalogs](http://timken.com/catalogs).

<sup>(3)</sup>Based on 90 x 10<sup>6</sup> revolutions L<sub>10</sub> life, for The Timken Company life-calculation method. C<sub>90</sub> and C<sub>a90</sub> are radial and thrust values for a single row. C<sub>90(2)</sub> is the double-row radial value.

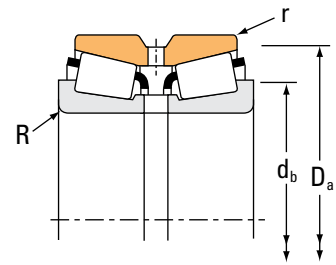
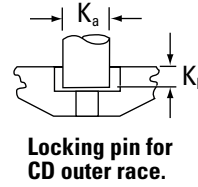
Part Number		Dimensions						Geometry Factors			Bearing Weight
Inner	Outer	Shaft		Housing		Pin		G <sub>1</sub>	G <sub>2</sub>	C <sub>G</sub>	
		Max. Shaft Fillet Radius R <sup>(4)</sup>	Backing Shoulder Dia. d <sub>b</sub>	Max. Housing Fillet Radius r <sup>(4)</sup>	Backing Shoulder Dia. D <sub>a</sub>	K <sub>a</sub>	K <sub>b</sub>				
		mm in.	mm in.	mm in.	mm in.	mm in.	mm in.				kg lbs.
465	452D	2.3 0.09	62.0 2.44	0.8 0.03	100.0 3.94	– –	– –	58.6	17.1	0.0946	2.79 6.15
396	394D	0.8 0.03	61.0 2.40	0.8 0.03	104.4 4.11	– –	– –	56.0	21.4	0.0984	2.22 4.92
L305649	L305610D	1.5 0.06	58.0 2.28	0.8 0.03	77.0 3.03	– –	– –	38.8	29.8	0.0841	0.77 1.71
368A	362XD	3.5 0.14	62.0 2.44	0.5 0.02	86.3 3.40	– –	– –	33.8	14.0	0.0773	1.27 2.79
368	363D	1.5 0.06	58.0 2.28	0.8 0.03	84.0 3.31	– –	– –	33.8	14.0	0.0773	1.16 2.57
368A	363D	3.5 0.14	62.0 2.44	0.8 0.03	84.0 3.31	– –	– –	33.8	14.0	0.0773	1.17 2.56
3775	3729D	0.8 0.03	58.0 2.28	0.8 0.03	87.9 3.46	– –	– –	49.9	14.5	0.0903	1.83 4.03
3780	3729D	3.5 0.14	64.0 2.52	0.8 0.03	87.9 3.46	– –	– –	49.9	14.5	0.0903	1.82 4.02
3784	3729D	6.4 0.25	70.0 2.76	0.8 0.03	87.9 3.46	– –	– –	49.9	14.5	0.0903	1.78 3.93
33889	33821D	3.5 0.14	64.0 2.52	0.8 0.03	90.0 3.54	– –	– –	52.5	18.5	0.0910	1.86 4.08
385A	384ED	2.3 0.09	61.0 2.40	0.8 0.03	93.0 3.66	– –	– –	42.0	15.7	0.0859	1.60 3.52
385A	-	2.3 0.09	61.0 2.40	0.8 0.03	93.0 3.66	7.94 0.31	4.77 0.19	42.0	15.7	0.0859	1.70 3.76
385A	384CD	2.3 0.09	61.0 2.40	0.8 0.03	93.0 3.66	– –	– –	42.0	15.7	0.0859	1.71 3.77
455	452D	0.8 0.03	60.0 2.36	0.8 0.03	100.0 3.94	– –	– –	58.6	17.1	0.0946	2.75 6.04
455-S	452D	3.5 0.14	65.0 2.56	0.8 0.03	100.0 3.94	– –	– –	58.6	17.1	0.0946	2.75 6.05
55200	55433D	3.5 0.14	71.0 2.80	0.5 0.02	105.0 4.13	– –	– –	36.8	13.2	0.1085	2.67 5.90
55200C	55433D	3.5 0.14	71.0 2.80	0.5 0.02	105.0 4.13	– –	– –	48.7	18.1	0.1198	2.86 6.29

<sup>(4)</sup>These maximum fillet radii will be cleared by bearing corners.  
NOTE: For spacer configuration information, contact your Timken engineer.

# TAPERED ROLLER BEARINGS

## DOUBLE-ROW • TYPE TDO

### TYPE TDO



Bearing Dimensions				Load Ratings							
Bore d	O.D. D	Width T	Double Outer Ring Width C	Dynamic <sup>(1)</sup>		Factors <sup>(2)</sup>		Dynamic <sup>(3)</sup>			Factors <sup>(2)</sup>
				C <sub>1(2)</sub>	e	Y <sub>1</sub>	Y <sub>2</sub>	C <sub>90</sub>	C <sub>a90</sub>	C <sub>90(2)</sub>	K
mm in.	mm in.	mm in.	mm in.	N lbf				N lbf	N lbf	N lbf	
50.800 2.0000	110.000 4.3307	52.388 2.0625	46.038 1.8125	172000 38700	0.40	1.68	2.50	25600 5760	17600 3970	44600 10000	1.45
50.800 2.0000	112.712 4.4375	65.088 2.5625	46.038 1.8125	220000 49400	0.88	0.76	1.14	32700 7350	49500 11100	56900 12800	0.66
50.800 2.0000	117.475 4.6250	73.025 2.8750	53.975 2.1250	307000 69100	0.63	1.08	1.60	45800 10300	49100 11000	79700 17900	0.93
50.800 2.0000	123.825 4.8750	79.375 3.1250	63.500 2.5000	332000 74700	0.35	1.95	2.90	49400 11100	29300 6590	86100 19400	1.69
51.592 2.0312	90.000 3.5433	50.010 1.9689	42.070 1.6563	177000 39900	0.32	2.11	3.14	26400 5930	14400 3250	46000 10300	1.83
52.387 2.0625	93.264 3.6718	65.088 2.5625	52.388 2.0625	213000 47800	0.34	1.99	2.97	31700 7120	18300 4120	55100 12400	1.73
52.387 2.0625	95.250 3.7500	63.500 2.5000	52.385 2.0624	226000 50800	0.33	2.05	3.05	33600 7560	19000 4270	58600 13200	1.77
52.387 2.0625	95.250 3.7500	63.500 2.5000	52.385 2.0624	226000 50800	0.33	2.05	3.05	33600 7560	19000 4270	58600 13200	1.77
52.387 2.0625	107.950 4.2500	65.090 2.5626	53.975 2.1250	280000 62900	0.34	2.01	3.00	41700 9370	23900 5380	72600 16300	1.74
52.387 2.0625	109.982 4.3300	63.500 2.5000	42.865 1.6876	220000 49400	0.88	0.76	1.14	32700 7350	49500 11100	56900 12800	0.66
52.387 2.0625	112.712 4.4375	65.088 2.5625	46.038 1.8125	220000 49400	0.88	0.76	1.14	32700 7350	49500 11100	56900 12800	0.66
53.975 2.1250	95.250 3.7500	63.500 2.5000	52.385 2.0624	226000 50800	0.33	2.05	3.05	33600 7560	19000 4270	58600 13200	1.77
53.975 2.1250	100.000 3.9370	49.200 1.9370	39.675 1.5620	188000 42200	0.35	1.91	2.84	28000 6280	16900 3810	48700 10900	1.65
53.975 2.1250	100.000 3.9370	52.388 2.0625	42.862 1.6875	188000 42200	0.35	1.91	2.84	28000 6280	16900 3810	48700 10900	1.65
53.975 2.1250	107.950 4.2500	65.090 2.5626	53.975 2.1250	280000 62900	0.34	2.01	3.00	41700 9370	23900 5380	72600 16300	1.74
53.975 2.1250	111.125 4.3750	79.375 3.1250	63.500 2.5000	355000 79800	0.30	2.28	3.39	52900 11900	26800 6040	92100 20700	1.97
53.975 2.1250	117.475 4.6250	73.025 2.8750	53.975 2.1250	307000 69100	0.63	1.08	1.60	45800 10300	49100 11000	79700 17900	0.93

<sup>(1)</sup>Based on  $1 \times 10^6$  revolutions  $L_{10}$  life, for the ISO life-calculation method.  $C_{1(2)}$  is the double-row radial value.

<sup>(2)</sup>Consult your Timken engineer for instructions on use or review the Timken Engineering Manual on [timken.com/catalogs](http://timken.com/catalogs).

<sup>(3)</sup>Based on  $90 \times 10^6$  revolutions  $L_{10}$  life, for The Timken Company life-calculation method.  $C_{90}$  and  $C_{a90}$  are radial and thrust values for a single row.  $C_{90(2)}$  is the double-row radial value.



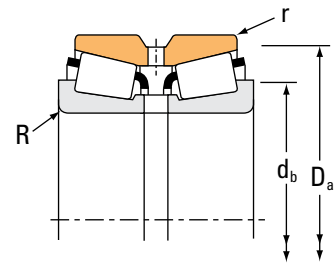
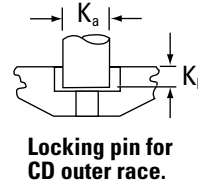
Part Number		Dimensions						Geometry Factors			Bearing Weight
Inner	Outer	Shaft		Housing		Pin		G <sub>1</sub>	G <sub>2</sub>	C <sub>G</sub>	
		Max. Shaft Fillet Radius R <sup>(4)</sup>	Backing Shoulder Dia. d <sub>b</sub>	Max. Housing Fillet Radius r <sup>(4)</sup>	Backing Shoulder Dia. D <sub>a</sub>	K <sub>a</sub>	K <sub>b</sub>				
		mm in.	mm in.	mm in.	mm in.	mm in.	mm in.				kg lbs.
398	394D	0.8 0.03	62.0 2.44	0.8 0.03	104.4 4.11	– –	– –	56.0	21.4	0.0984	2.28 5.04
55200	55444D	3.5 0.14	71.0 2.80	1.5 0.06	105.0 4.13	– –	– –	36.8	13.2	0.1085	2.78 6.14
66200	66462D	3.5 0.14	71.0 2.80	0.8 0.03	111.0 4.37	– –	– –	50.2	16.4	0.0751	3.65 8.05
555	552D	2.3 0.09	66.0 2.60	1.5 0.06	115.0 4.53	– –	– –	91.0	21.1	0.1108	4.76 10.51
368-S	363D	2.0 0.08	59.0 2.32	0.8 0.03	84.0 3.31	– –	– –	33.8	14.0	0.0773	1.15 2.54
3767	3729D	2.3 0.09	63.0 2.48	0.8 0.03	87.9 3.46	– –	– –	49.9	14.5	0.0903	1.78 3.90
33890	33821D	1.5 0.06	61.0 2.40	0.8 0.03	90.0 3.54	– –	– –	52.5	18.5	0.0910	1.83 4.00
33891	33821D	3.5 0.14	66.0 2.60	0.8 0.03	90.0 3.54	– –	– –	52.5	18.5	0.0910	1.81 3.97
468	452D	1.5 0.06	62.0 2.44	0.8 0.03	100.0 3.94	– –	– –	58.6	17.1	0.0946	2.63 5.80
55206	55433D	3.5 0.14	72.0 2.83	0.5 0.02	105.0 4.13	– –	– –	36.8	13.2	0.1085	2.61 5.73
55206	55444D	3.5 0.14	72.0 2.83	1.5 0.06	105.0 4.13	– –	– –	36.8	13.2	0.1085	2.73 5.98
33895	33821D	1.5 0.06	63.0 2.48	0.8 0.03	90.0 3.54	– –	– –	52.5	18.5	0.0910	1.75 3.84
389A	384ED	0.8 0.03	61.0 2.40	0.8 0.03	93.0 3.66	– –	– –	42.0	15.7	0.0859	1.52 3.34
389A	384D	0.8 0.03	61.0 2.40	0.8 0.03	93.0 3.66	– –	– –	42.0	15.7	0.0859	1.60 3.52
456	452D	3.5 0.14	68.0 2.68	0.8 0.03	100.0 3.94	– –	– –	58.6	17.1	0.0946	2.61 5.74
539	533D	3.5 0.14	68.0 2.68	1.5 0.06	100.0 3.94	– –	– –	64.3	16.1	0.0938	3.33 7.35
66212	66462D	3.5 0.14	73.0 2.87	0.8 0.03	111.0 4.37	– –	– –	50.2	16.4	0.0751	3.58 7.87

<sup>(4)</sup>These maximum fillet radii will be cleared by bearing corners.  
NOTE: For spacer configuration information, contact your Timken engineer.

# TAPERED ROLLER BEARINGS

## DOUBLE-ROW • TYPE TDO

### TYPE TDO



Bearing Dimensions				Load Ratings							
Bore d	O.D. D	Width T	Double Outer Ring Width C	Dynamic <sup>(1)</sup>				Dynamic <sup>(3)</sup>			
				C <sub>1(2)</sub>	e	Y <sub>1</sub>	Y <sub>2</sub>	C <sub>90</sub>	C <sub>a90</sub>	C <sub>90(2)</sub>	K
mm in.	mm in.	mm in.	mm in.	N lbf				N lbf	N lbf	N lbf	
53.975 2.1250	123.825 4.8750	79.375 3.1250	63.500 2.5000	394000 88500	0.35	1.95	2.90	58600 13200	34700 7810	102000 22900	1.69
53.975 2.1250	139.700 5.5000	77.788 3.0625	51.803 2.0395	412000 92600	0.87	0.78	1.16	61300 13800	90900 20400	107000 24000	0.67
54.987 2.1649	107.950 4.2500	65.090 2.5626	53.975 2.1250	280000 62900	0.34	2.01	3.00	41700 9370	23900 5380	72600 16300	1.74
55.000 2.1654	100.000 3.9370	49.200 1.9370	39.675 1.5620	188000 42200	0.35	1.91	2.84	28000 6280	16900 3810	48700 10900	1.65
55.000 2.1654	100.000 3.9370	49.200 1.9370	39.675 1.5620	188000 42200	0.35	1.91	2.84	28000 6280	16900 3810	48700 10900	1.65
55.000 2.1654	100.000 3.9370	52.388 2.0625	42.862 1.6875	188000 42200	0.35	1.91	2.84	28000 6280	16900 3810	48700 10900	1.65
55.000 2.1654	100.000 3.9370	52.388 2.0625	42.862 1.6875	188000 42200	0.35	1.91	2.84	28000 6280	16900 3810	48700 10900	1.65
55.000 2.1654	120.000 4.7244	65.090 2.5626	53.975 2.1250	250000 56100	0.38	1.75	2.61	37200 8360	24500 5500	64700 14600	1.52
55.562 2.1875	107.950 4.2500	65.090 2.5626	53.975 2.1250	280000 62900	0.34	2.01	3.00	41700 9370	23900 5380	72600 16300	1.74
55.575 2.1880	100.000 3.9370	49.200 1.9370	39.675 1.5620	188000 42200	0.35	1.91	2.84	28000 6280	16900 3810	48700 10900	1.65
57.150 2.2500	92.075 3.6250	42.070 1.6563	34.130 1.3437	109000 24500	0.39	1.74	2.59	16300 3650	10800 2430	28300 6360	1.50
57.150 2.2500	100.000 3.9370	49.200 1.9370	39.675 1.5620	188000 42200	0.35	1.91	2.84	28000 6280	16900 3810	48700 10900	1.65
57.150 2.2500	100.000 3.9370	49.200 1.9370	39.675 1.5620	188000 42200	0.35	1.91	2.84	28000 6280	16900 3810	48700 10900	1.65
57.150 2.2500	100.000 3.9370	49.200 1.9370	39.675 1.5620	188000 42200	0.35	1.91	2.84	28000 6280	16900 3810	48700 10900	1.65
57.150 2.2500	100.000 3.9370	49.200 1.9370	39.675 1.5620	188000 42200	0.35	1.91	2.84	28000 6280	16900 3810	48700 10900	1.65
57.150 2.2500	100.000 3.9370	52.388 2.0625	42.862 1.6875	188000 42200	0.35	1.91	2.84	28000 6280	16900 3810	48700 10900	1.65
57.150 2.2500	100.000 3.9370	52.388 2.0625	42.862 1.6875	188000 42200	0.35	1.91	2.84	28000 6280	16900 3810	48700 10900	1.65

<sup>(1)</sup>Based on  $1 \times 10^6$  revolutions  $L_{10}$  life, for the ISO life-calculation method.  $C_{1(2)}$  is the double-row radial value.

<sup>(2)</sup>Consult your Timken engineer for instructions on use or review the Timken Engineering Manual on [timken.com/catalogs](http://timken.com/catalogs).

<sup>(3)</sup>Based on  $90 \times 10^6$  revolutions  $L_{10}$  life, for The Timken Company life-calculation method.  $C_{90}$  and  $C_{a90}$  are radial and thrust values for a single row.  $C_{90(2)}$  is the double-row radial value.

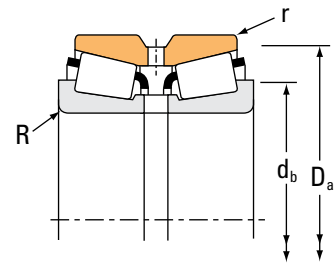
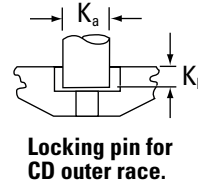
Part Number		Dimensions						Geometry Factors			Bearing Weight
Inner	Outer	Shaft		Housing		Pin		G <sub>1</sub>	G <sub>2</sub>	C <sub>G</sub>	
		Max. Shaft Fillet Radius R <sup>(4)</sup>	Backing Shoulder Dia. d <sub>b</sub>	Max. Housing Fillet Radius r <sup>(4)</sup>	Backing Shoulder Dia. D <sub>a</sub>	K <sub>a</sub>	K <sub>b</sub>				
		mm in.	mm in.	mm in.	mm in.	mm in.	mm in.				kg lbs.
557-S	552D	3.5 0.14	73.0 2.87	1.5 0.06	115.0 4.53	– –	– –	91.0	21.1	0.1108	4.65 10.24
78215C	78549D	3.5 0.14	84.0 3.31	1.5 0.06	131.0 5.16	– –	– –	71.3	17.6	0.0926	5.81 12.80
466	452D	2.3 0.09	66.0 2.60	0.8 0.03	100.0 3.94	– –	– –	58.6	17.1	0.0946	2.59 5.68
385	384ED	2.3 0.09	65.0 2.56	0.8 0.03	93.0 3.66	– –	– –	42.0	15.7	0.0859	1.48 3.26
385X	384ED	3.5 0.14	67.0 2.64	0.8 0.03	93.0 3.66	– –	– –	42.0	15.7	0.0859	1.48 3.25
385	384D	2.3 0.09	65.0 2.56	0.8 0.03	93.0 3.66	– –	– –	42.0	15.7	0.0859	1.55 3.42
385X	384D	3.5 0.14	67.0 2.64	0.8 0.03	93.0 3.66	– –	– –	42.0	15.7	0.0859	1.55 3.41
475	472D	0.8 0.03	67.0 2.64	0.8 0.03	114.0 4.49	– –	– –	77.2	23.0	0.1083	3.65 8.05
466-S	452D	2.3 0.09	66.0 2.60	0.8 0.03	100.0 3.94	– –	– –	58.6	17.1	0.0946	2.55 5.63
389	384ED	2.3 0.09	65.0 2.56	0.8 0.03	93.0 3.66	– –	– –	42.0	15.7	0.0859	1.45 3.21
L507949	L507914D	1.5 0.06	65.0 2.56	0.8 0.03	86.0 3.39	– –	– –	46.1	38.5	0.0914	1.08 2.36
387	384ED	2.3 0.09	67.0 2.64	0.8 0.03	93.0 3.66	– –	– –	42.0	15.7	0.0859	1.41 3.09
387A	384ED	3.5 0.14	70.0 2.76	0.8 0.03	93.0 3.66	– –	– –	42.0	15.7	0.0859	1.42 3.11
387AS	384ED	5.0 0.20	73.0 2.87	0.8 0.03	93.0 3.66	– –	– –	42.0	15.7	0.0859	1.42 3.09
387-S	384ED	0.8 0.03	64.0 2.52	0.8 0.03	93.0 3.66	– –	– –	42.0	15.7	0.0859	1.42 3.13
387	384D	2.3 0.09	67.0 2.64	0.8 0.03	93.0 3.66	– –	– –	42.0	15.7	0.0859	1.49 3.28
387A	384D	3.5 0.14	70.0 2.76	0.8 0.03	93.0 3.66	– –	– –	42.0	15.7	0.0859	1.49 3.27

<sup>(4)</sup>These maximum fillet radii will be cleared by bearing corners.  
NOTE: For spacer configuration information, contact your Timken engineer.

# TAPERED ROLLER BEARINGS

## DOUBLE-ROW • TYPE TDO

### TYPE TDO



Bearing Dimensions				Load Ratings							
Bore d	O.D. D	Width T	Double Outer Ring Width C	Dynamic <sup>(1)</sup>				Dynamic <sup>(3)</sup>			
				C <sub>1(2)</sub>	e	Y <sub>1</sub>	Y <sub>2</sub>	C <sub>90</sub>	C <sub>a90</sub>	C <sub>90(2)</sub>	K
mm in.	mm in.	mm in.	mm in.	N lbf				N lbf	N lbf	N lbf	
57.150 2.2500	100.000 3.9370	52.388 2.0625	42.862 1.6875	188000 42200	0.35	1.91	2.84	28000 6280	16900 3810	48700 10900	1.65
57.150 2.2500	100.000 3.9370	52.388 2.0625	42.862 1.6875	188000 42200	0.35	1.91	2.84	28000 6280	16900 3810	48700 10900	1.65
57.150 2.2500	100.000 3.9370	105.131 4.1390	95.606 3.7640	188000 42200	0.35	1.91	2.84	28000 6280	16900 3810	48700 10900	1.65
57.150 2.2500	107.950 4.2500	65.090 2.5626	53.975 2.1250	280000 62900	0.34	2.01	3.00	41700 9370	23900 5380	72600 16300	1.74
57.150 2.2500	107.950 4.2500	65.090 2.5626	53.975 2.1250	280000 62900	0.34	2.01	3.00	41700 9370	23900 5380	72600 16300	1.74
57.150 2.2500	110.000 4.3307	52.388 2.0625	46.038 1.8125	172000 38700	0.40	1.68	2.50	25600 5760	17600 3970	44600 10000	1.45
57.150 2.2500	114.287 4.4995	58.738 2.3125	46.038 1.8125	192000 43300	0.49	1.38	2.06	28600 6440	23900 5370	49900 11200	1.20
57.150 2.2500	117.475 4.6250	66.675 2.6250	53.975 2.1250	241000 54200	0.44	1.55	2.31	35900 8060	26800 6020	62400 14000	1.34
57.150 2.2500	117.475 4.6250	73.025 2.8750	53.975 2.1250	307000 69100	0.63	1.08	1.60	45800 10300	49100 11000	79700 17900	0.93
57.150 2.2500	123.825 4.8750	77.788 3.0625	55.562 2.1875	373000 83900	0.74	0.92	1.36	55500 12500	70100 15800	96700 21700	0.79
57.150 2.2500	123.825 4.8750	79.375 3.1250	63.500 2.5000	394000 88500	0.35	1.95	2.90	58600 13200	34700 7810	102000 22900	1.69
57.150 2.2500	136.525 5.3750	95.250 3.7500	76.200 3.0000	406000 91200	0.36	1.86	2.78	60400 13600	37400 8420	105000 23600	1.61
57.150 2.2500	139.700 5.5000	77.788 3.0625	51.803 2.0395	353000 79300	0.87	0.78	1.16	52600 11800	77900 17500	91500 20600	0.67
57.531 2.2650	100.000 3.9370	49.200 1.9370	39.675 1.5620	188000 42200	0.35	1.91	2.84	28000 6280	16900 3810	48700 10900	1.65
57.531 2.2650	100.000 3.9370	52.388 2.0625	42.862 1.6875	188000 42200	0.35	1.91	2.84	28000 6280	16900 3810	48700 10900	1.65
59.972 2.3611	129.982 5.1174	69.850 2.7500	47.625 1.8750	319000 71700	0.67	1.01	1.51	47500 10700	54100 12200	82700 18600	0.88
59.977 2.3613	100.000 3.9370	55.560 2.1874	44.450 1.7500	185000 41500	0.43	1.59	2.36	27500 6180	20000 4500	47900 10800	1.37

<sup>(1)</sup>Based on 1 x 10<sup>6</sup> revolutions L<sub>10</sub> life, for the ISO life-calculation method. C<sub>1(2)</sub> is the double-row radial value.

<sup>(2)</sup>Consult your Timken engineer for instructions on use or review the Timken Engineering Manual on [timken.com/catalogs](http://timken.com/catalogs).

<sup>(3)</sup>Based on 90 x 10<sup>6</sup> revolutions L<sub>10</sub> life, for The Timken Company life-calculation method. C<sub>90</sub> and C<sub>a90</sub> are radial and thrust values for a single row. C<sub>90(2)</sub> is the double-row radial value.

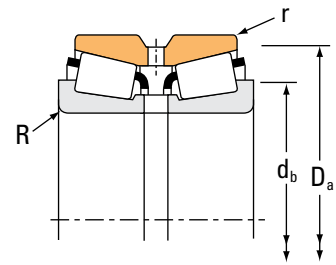
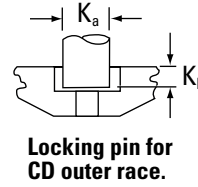
Part Number		Dimensions						Geometry Factors			Bearing Weight
Inner	Outer	Shaft		Housing		Pin		G <sub>1</sub>	G <sub>2</sub>	C <sub>G</sub>	
		Max. Shaft Fillet Radius R <sup>(4)</sup>	Backing Shoulder Dia. d <sub>b</sub>	Max. Housing Fillet Radius r <sup>(4)</sup>	Backing Shoulder Dia. D <sub>a</sub>	K <sub>a</sub>	K <sub>b</sub>				
		mm in.	mm in.	mm in.	mm in.	mm in.	mm in.				kg lbs.
387AS	384D	5.0 0.20	73.0 2.87	0.8 0.03	93.0 3.66	– –	– –	42.0	15.7	0.0859	1.49 3.25
387-S	384D	0.8 0.03	64.0 2.52	0.8 0.03	93.0 3.66	– –	– –	42.0	15.7	0.0859	1.49 3.29
387A	384XD	3.5 0.14	70.0 2.76	0.8 0.03	94.0 3.70	– –	– –	42.0	15.7	0.0859	2.92 6.42
462	452D	2.3 0.09	67.0 2.64	0.8 0.03	100.0 3.94	– –	– –	58.6	17.1	0.0946	2.48 5.48
469	452D	3.5 0.14	72.0 2.83	0.8 0.03	100.0 3.94	– –	– –	58.6	17.1	0.0946	2.48 5.47
390	394D	2.3 0.09	70.0 2.76	0.8 0.03	104.4 4.11	– –	– –	56.0	21.4	0.0984	2.08 4.58
29665	29622D	3.5 0.14	75.0 2.95	0.8 0.03	109.0 4.29	– –	– –	77.7	43.3	0.1170	2.76 6.07
33225	33462D	3.5 0.14	74.0 2.91	0.8 0.03	112.0 4.41	– –	– –	84.2	25.9	0.1162	3.43 7.57
66225	66462D	3.5 0.14	76.0 2.99	0.8 0.03	111.0 4.37	– –	– –	50.2	16.4	0.0751	3.35 7.37
72225C	72488D	3.5 0.14	81.0 3.19	1.5 0.06	115.0 4.53	– –	– –	57.4	15.9	0.0825	4.14 9.13
555-S	552D	3.5 0.14	76.0 2.99	1.5 0.06	115.0 4.53	– –	– –	91.0	21.1	0.1108	4.48 9.88
635	632D	3.5 0.14	75.0 2.95	1.5 0.06	125.0 4.92	– –	– –	106.4	21.0	0.0814	6.76 14.88
78225	78549D	3.5 0.14	83.0 3.27	1.5 0.06	131.0 5.16	– –	– –	62.6	19.1	0.0884	5.40 11.91
388A	384ED	3.5 0.14	70.0 2.76	0.8 0.03	93.0 3.66	– –	– –	42.0	15.7	0.0859	1.44 3.17
388A	384D	3.5 0.14	70.0 2.76	0.8 0.03	93.0 3.66	– –	– –	42.0	15.7	0.0859	1.46 3.23
66589	66522D	0.8 0.03	74.0 2.91	0.8 0.03	118.0 4.65	– –	– –	57.0	18.3	0.0797	3.94 8.68
28980	28921D	3.5 0.14	73.0 2.87	0.8 0.03	96.0 3.78	– –	– –	60.1	24.5	0.1032	1.67 3.67

<sup>(4)</sup>These maximum fillet radii will be cleared by bearing corners.  
NOTE: For spacer configuration information, contact your Timken engineer.

# TAPERED ROLLER BEARINGS

## DOUBLE-ROW • TYPE TDO

### TYPE TDO



Bearing Dimensions				Load Ratings							
Bore d	O.D. D	Width T	Double Outer Ring Width C	Dynamic <sup>(1)</sup>		Factors <sup>(2)</sup>		Dynamic <sup>(3)</sup>			Factors <sup>(2)</sup>
				C <sub>1(2)</sub>	e	Y <sub>1</sub>	Y <sub>2</sub>	C <sub>90</sub>	C <sub>a90</sub>	C <sub>90(2)</sub>	K
mm in.	mm in.	mm in.	mm in.	N lbf				N lbf	N lbf	N lbf	
59.987 2.3617	123.825 4.8750	79.375 3.1250	63.500 2.5000	332000 74700	0.35	1.95	2.90	49400 11100	29300 6590	86100 19400	1.69
60.000 2.3622	110.000 4.3307	52.388 2.0625	46.038 1.8125	172000 38700	0.40	1.68	2.50	25600 5760	17600 3970	44600 10000	1.45
60.000 2.3622	120.000 4.7244	65.090 2.5626	53.975 2.1250	250000 56100	0.38	1.75	2.61	37200 8360	24500 5500	64700 14600	1.52
60.000 2.3622	129.982 5.1174	69.850 2.7500	47.625 1.8750	319000 71700	0.67	1.01	1.51	47500 10700	54100 12200	82700 18600	0.88
60.325 2.3750	100.000 3.9370	55.560 2.1874	44.450 1.7500	185000 41500	0.43	1.59	2.36	27500 6180	20000 4500	47900 10800	1.37
60.325 2.3750	123.825 4.8750	79.375 3.1250	63.500 2.5000	394000 88500	0.35	1.95	2.90	58600 13200	34700 7810	102000 22900	1.69
60.325 2.3750	123.825 4.8750	79.375 3.1250	63.500 2.5000	332000 74700	0.35	1.95	2.90	49400 11100	29300 6590	86100 19400	1.69
60.325 2.3750	136.525 5.3750	95.250 3.7500	76.200 3.0000	406000 91200	0.36	1.86	2.78	60400 13600	37400 8420	105000 23600	1.61
61.912 2.4375	110.000 4.3307	52.388 2.0625	46.038 1.8125	172000 38700	0.40	1.68	2.50	25600 5760	17600 3970	44600 10000	1.45
61.912 2.4375	123.825 4.8750	79.375 3.1250	63.500 2.5000	332000 74700	0.35	1.95	2.90	49400 11100	29300 6590	86100 19400	1.69
62.737 2.4700	100.000 3.9370	55.560 2.1874	44.450 1.7500	185000 41500	0.43	1.59	2.36	27500 6180	20000 4500	47900 10800	1.37
63.500 2.5000	94.458 3.7188	42.860 1.6874	34.925 1.3750	117000 26200	0.42	1.59	2.37	17400 3910	12600 2840	30200 6800	1.38
63.500 2.5000	110.000 4.3307	52.388 2.0625	46.038 1.8125	172000 38700	0.40	1.68	2.50	25600 5760	17600 3970	44600 10000	1.45
63.500 2.5000	110.000 4.3307	52.388 2.0625	46.038 1.8125	172000 38700	0.40	1.68	2.50	25600 5760	17600 3970	44600 10000	1.45
63.500 2.5000	112.712 4.4375	55.562 2.1875	42.862 1.6875	227000 51100	0.46	1.47	2.19	33800 7610	26600 5970	58900 13200	1.27
63.500 2.5000	117.475 4.6250	66.675 2.6250	53.975 2.1250	241000 54200	0.44	1.55	2.31	35900 8060	26800 6020	62400 14000	1.34
63.500 2.5000	120.000 4.7244	65.090 2.5626	53.975 2.1250	250000 56100	0.38	1.75	2.61	37200 8360	24500 5500	64700 14600	1.52

<sup>(1)</sup>Based on 1 x 10<sup>6</sup> revolutions L<sub>10</sub> life, for the ISO life-calculation method. C<sub>1(2)</sub> is the double-row radial value.

<sup>(2)</sup>Consult your Timken engineer for instructions on use or review the Timken Engineering Manual on [timken.com/catalogs](http://timken.com/catalogs).

<sup>(3)</sup>Based on 90 x 10<sup>6</sup> revolutions L<sub>10</sub> life, for The Timken Company life-calculation method. C<sub>90</sub> and C<sub>a90</sub> are radial and thrust values for a single row. C<sub>90(2)</sub> is the double-row radial value.

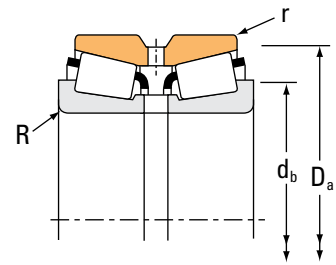
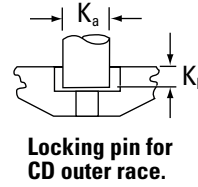
Part Number		Dimensions						Geometry Factors			Bearing Weight
Inner	Outer	Shaft		Housing		Pin		G <sub>1</sub>	G <sub>2</sub>	C <sub>G</sub>	
		Max. Shaft Fillet Radius R <sup>(4)</sup>	Backing Shoulder Dia. d <sub>b</sub>	Max. Housing Fillet Radius r <sup>(4)</sup>	Backing Shoulder Dia. D <sub>a</sub>	K <sub>a</sub>	K <sub>b</sub>				
		mm in.	mm in.	mm in.	mm in.	mm in.	mm in.				kg lbs.
558-S	552D	3.5 0.14	75.0 2.95	1.5 0.06	115.0 4.53	– –	– –	91.0	21.1	0.1108	4.31 9.50
397	394D	0.8 0.03	69.0 2.72	0.8 0.03	104.4 4.11	– –	– –	56.0	21.4	0.0984	2.02 4.43
476	472D	2.0 0.08	73.0 2.87	0.8 0.03	114.0 4.49	– –	– –	77.2	23.0	0.1083	3.43 7.54
66585	66522D	3.5 0.14	79.0 3.11	0.8 0.03	118.0 4.65	– –	– –	57.0	18.3	0.0797	3.92 8.64
28985	28921D	3.5 0.14	73.0 2.87	0.8 0.03	96.0 3.78	– –	– –	60.1	24.5	0.1032	1.64 3.62
558	552D	2.3 0.09	76.0 2.99	1.5 0.06	115.0 4.53	– –	– –	91.0	21.1	0.1108	4.32 9.50
558A	552D	3.5 0.14	76.0 2.99	1.5 0.06	115.0 4.53	– –	– –	91.0	21.1	0.1108	4.30 9.47
637	632D	3.5 0.14	78.0 3.07	1.5 0.06	125.0 4.92	– –	– –	106.4	21.0	0.0814	6.55 14.40
392	394D	0.8 0.03	70.0 2.76	0.8 0.03	104.4 4.11	– –	– –	56.0	21.4	0.0984	1.96 4.35
554	552D	3.5 0.14	77.0 3.03	1.5 0.06	115.0 4.53	– –	– –	91.0	21.1	0.1108	4.19 9.26
28995	28921D	3.5 0.14	75.0 2.95	0.8 0.03	96.0 3.78	– –	– –	60.1	24.5	0.1032	1.54 3.42
L610549	L610510D	1.5 0.06	71.0 2.80	0.8 0.03	91.0 3.58	– –	– –	56.7	50.3	0.1006	0.99 2.17
395	394D	3.5 0.14	77.0 3.03	0.8 0.03	104.4 4.11	– –	– –	56.0	21.4	0.0984	1.86 4.12
390A	394D	1.5 0.06	73.0 2.87	0.8 0.03	104.4 4.11	– –	– –	56.0	21.4	0.0984	1.90 4.18
29586	29526D	1.5 0.06	73.0 2.87	0.8 0.03	105.0 4.13	– –	– –	70.3	25.9	0.1112	2.19 4.81
33251	33462D	0.8 0.03	73.0 2.87	0.8 0.03	112.0 4.41	– –	– –	84.2	25.9	0.1162	3.18 7.02
477	472D	0.8 0.03	73.0 2.87	0.8 0.03	114.0 4.49	– –	– –	77.2	23.0	0.1083	3.25 7.17

<sup>(4)</sup>These maximum fillet radii will be cleared by bearing corners.  
NOTE: For spacer configuration information, contact your Timken engineer.

# TAPERED ROLLER BEARINGS

## DOUBLE-ROW • TYPE TDO

### TYPE TDO



Bearing Dimensions				Load Ratings							
Bore d	O.D. D	Width T	Double Outer Ring Width C	Dynamic <sup>(1)</sup>		Factors <sup>(2)</sup>		Dynamic <sup>(3)</sup>			Factors <sup>(2)</sup>
				C <sub>1(2)</sub>	e	Y <sub>1</sub>	Y <sub>2</sub>	C <sub>90</sub>	C <sub>a90</sub>	C <sub>90(2)</sub>	K
mm in.	mm in.	mm in.	mm in.	N lbf				N lbf	N lbf	N lbf	
63.500 2.5000	120.000 4.7244	65.090 2.5626	53.975 2.1250	250000 56100	0.38	1.75	2.61	37200 8360	24500 5500	64700 14600	1.52
63.500 2.5000	123.825 4.8750	79.375 3.1250	63.500 2.5000	394000 88500	0.35	1.95	2.90	58600 13200	34700 7810	102000 22900	1.69
63.500 2.5000	127.000 5.0000	80.962 3.1875	65.088 2.5625	342000 76900	0.36	1.86	2.76	50900 11400	31700 7130	88600 19900	1.61
63.500 2.5000	136.525 5.3750	95.250 3.7500	76.200 3.0000	481000 108000	0.36	1.86	2.78	71600 16100	44400 9980	125000 28000	1.61
63.500 2.5000	139.700 5.5000	77.788 3.0625	51.803 2.0395	353000 79300	0.87	0.78	1.16	52600 11800	77900 17500	91500 20600	0.67
63.500 2.5000	155.575 6.1250	101.600 4.0000	85.725 3.3750	656000 147000	0.33	2.08	3.09	97600 21900	54400 12200	170000 38200	1.80
64.960 2.5575	155.575 6.1250	101.600 4.0000	85.725 3.3750	553000 124000	0.33	2.08	3.09	82400 18500	45900 10300	143000 32200	1.80
64.963 2.5576	127.000 5.0000	80.962 3.1875	65.088 2.5625	342000 76900	0.36	1.86	2.76	50900 11400	31700 7130	88600 19900	1.61
64.987 2.5586	139.700 5.5000	77.788 3.0625	51.803 2.0395	353000 79300	0.87	0.78	1.16	52600 11800	77900 17500	91500 20600	0.67
65.000 2.5591	120.000 4.7244	65.090 2.5626	53.975 2.1250	250000 56100	0.38	1.75	2.61	37200 8360	24500 5500	64700 14600	1.52
66.675 2.6250	110.000 4.3307	52.388 2.0625	46.038 1.8125	172000 38700	0.40	1.68	2.50	25600 5760	17600 3970	44600 10000	1.45
66.675 2.6250	110.000 4.3307	52.388 2.0625	46.038 1.8125	172000 38700	0.40	1.68	2.50	25600 5760	17600 3970	44600 10000	1.45
66.675 2.6250	117.475 4.6250	66.675 2.6250	53.975 2.1250	241000 54200	0.44	1.55	2.31	35900 8060	26800 6020	62400 14000	1.34
66.675 2.6250	120.000 4.7244	65.090 2.5626	53.975 2.1250	250000 56100	0.38	1.75	2.61	37200 8360	24500 5500	64700 14600	1.52
66.675 2.6250	123.825 4.8750	79.375 3.1250	63.500 2.5000	394000 88500	0.35	1.95	2.90	58600 13200	34700 7810	102000 22900	1.69
66.675 2.6250	136.525 5.3750	95.250 3.7500	76.200 3.0000	481000 108000	0.36	1.86	2.78	71600 16100	44400 9980	125000 28000	1.61
68.262 2.6875	110.000 4.3307	52.388 2.0625	46.038 1.8125	172000 38700	0.40	1.68	2.50	25600 5760	17600 3970	44600 10000	1.45

<sup>(1)</sup>Based on  $1 \times 10^6$  revolutions  $L_{10}$  life, for the ISO life-calculation method.  $C_{1(2)}$  is the double-row radial value.

<sup>(2)</sup>Consult your Timken engineer for instructions on use or review the Timken Engineering Manual on [timken.com/catalogs](http://timken.com/catalogs).

<sup>(3)</sup>Based on  $90 \times 10^6$  revolutions  $L_{10}$  life, for The Timken Company life-calculation method.  $C_{90}$  and  $C_{a90}$  are radial and thrust values for a single row.  $C_{90(2)}$  is the double-row radial value.



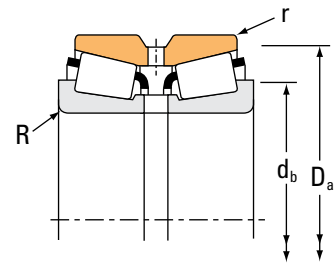
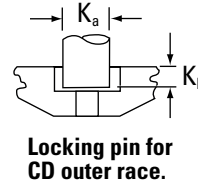
Part Number		Dimensions						Geometry Factors			Bearing Weight
Inner	Outer	Shaft		Housing		Pin		G <sub>1</sub>	G <sub>2</sub>	C <sub>G</sub>	
		Max. Shaft Fillet Radius R <sup>(4)</sup>	Backing Shoulder Dia. d <sub>b</sub>	Max. Housing Fillet Radius r <sup>(4)</sup>	Backing Shoulder Dia. D <sub>a</sub>	K <sub>a</sub>	K <sub>b</sub>				
		mm in.	mm in.	mm in.	mm in.	mm in.	mm in.				kg lbs.
483	472D	3.5 0.14	78.0 3.07	0.8 0.03	114.0 4.49	– –	– –	77.2	23.0	0.1083	3.25 7.19
559	552D	3.5 0.14	81.0 3.19	1.5 0.06	115.0 4.53	– –	– –	91.0	21.1	0.1108	4.25 9.40
565	563D	3.5 0.14	80.0 3.15	1.5 0.06	119.0 4.69	– –	– –	101.3	24.0	0.1167	4.53 9.99
639	632D	3.5 0.14	81.0 3.19	1.5 0.06	125.0 4.92	– –	– –	106.4	21.0	0.0814	6.28 13.82
78250	78549D	2.3 0.09	85.0 3.35	1.5 0.06	131.0 5.16	– –	– –	62.6	19.1	0.0884	5.10 11.24
745-S	742D	3.5 0.14	84.0 3.31	1.5 0.06	143.0 5.63	– –	– –	159.6	26.3	0.0898	9.77 21.54
747-S	742D	3.5 0.14	85.0 3.35	1.5 0.06	143.0 5.63	– –	– –	159.6	26.3	0.0898	9.74 21.47
569	563D	3.5 0.14	81.0 3.19	1.5 0.06	119.0 4.69	– –	– –	101.3	24.0	0.1167	4.43 9.79
78255X	78549D	3.5 0.14	89.0 3.50	1.5 0.06	131.0 5.16	– –	– –	62.6	19.1	0.0884	4.99 11.00
478	472D	2.3 0.09	77.0 3.03	0.8 0.03	114.0 4.49	– –	– –	77.2	23.0	0.1083	3.17 7.00
395A	394D	0.8 0.03	73.0 2.87	0.8 0.03	104.4 4.11	– –	– –	56.0	21.4	0.0984	1.76 3.89
395-S	394D	3.5 0.14	79.0 3.11	0.8 0.03	104.4 4.11	– –	– –	56.0	21.4	0.0984	1.76 3.88
33262	33462D	3.5 0.14	81.0 3.19	0.8 0.03	112.0 4.41	– –	– –	84.2	25.9	0.1162	2.95 6.52
479	472D	2.3 0.09	78.0 3.07	0.8 0.03	114.0 4.49	– –	– –	77.2	23.0	0.1083	3.11 6.83
560	552D	3.5 0.14	84.0 3.31	1.5 0.06	115.0 4.53	– –	– –	91.0	21.1	0.1108	3.89 8.59
641	632D	3.5 0.14	83.0 3.27	1.5 0.06	125.0 4.92	– –	– –	106.4	21.0	0.0814	6.06 13.35
399A	394D	2.3 0.09	78.0 3.07	0.8 0.03	104.4 4.11	– –	– –	56.0	21.4	0.0984	1.69 3.72

<sup>(4)</sup>These maximum fillet radii will be cleared by bearing corners.  
NOTE: For spacer configuration information, contact your Timken engineer.

# TAPERED ROLLER BEARINGS

## DOUBLE-ROW • TYPE TDO

### TYPE TDO



Bearing Dimensions				Load Ratings							
Bore d	O.D. D	Width T	Double Outer Ring Width C	Dynamic <sup>(1)</sup>				Dynamic <sup>(3)</sup>			
				C <sub>1(2)</sub>	e	Y <sub>1</sub>	Y <sub>2</sub>	C <sub>90</sub>	C <sub>a90</sub>	C <sub>90(2)</sub>	K
mm in.	mm in.	mm in.	mm in.	N lbf				N lbf	N lbf	N lbf	
68.262 2.6875	110.000 4.3307	52.388 2.0625	46.038 1.8125	172000 38700	0.40	1.68	2.50	25600 5760	17600 3970	44600 10000	1.45
68.262 2.6875	120.000 4.7244	65.090 2.5626	53.975 2.1250	250000 56100	0.38	1.75	2.61	37200 8360	24500 5500	64700 14600	1.52
68.262 2.6875	123.825 4.8750	79.375 3.1250	63.500 2.5000	332000 74700	0.35	1.95	2.90	49400 11100	29300 6590	86100 19400	1.69
68.262 2.6875	127.000 5.0000	80.962 3.1875	65.088 2.5625	342000 76900	0.36	1.86	2.76	50900 11400	31700 7130	88600 19900	1.61
68.262 2.6875	136.525 5.3750	95.250 3.7500	76.200 3.0000	406000 91200	0.36	1.86	2.78	60400 13600	37400 8420	105000 23600	1.61
68.262 2.6875	161.925 6.3750	105.562 4.1560	70.637 2.7810	614000 138000	0.71	0.95	1.42	91400 20600	111000 24900	159000 35800	0.82
69.850 2.7500	114.287 4.4995	58.738 2.3125	46.038 1.8125	192000 43300	0.49	1.38	2.06	28600 6440	23900 5370	49900 11200	1.20
69.850 2.7500	117.475 4.6250	66.675 2.6250	53.975 2.1250	241000 54200	0.44	1.55	2.31	35900 8060	26800 6020	62400 14000	1.34
69.850 2.7500	120.000 4.7244	65.090 2.5626	53.975 2.1250	250000 56100	0.38	1.75	2.61	37200 8360	24500 5500	64700 14600	1.52
69.850 2.7500	120.000 4.7244	71.438 2.8125	58.738 2.3125	311000 70000	0.36	1.87	2.79	46300 10400	28600 6420	80700 18100	1.62
69.850 2.7500	127.000 5.0000	80.962 3.1875	65.088 2.5625	342000 76900	0.36	1.86	2.76	50900 11400	31700 7130	88600 19900	1.61
69.850 2.7500	136.525 5.3750	95.250 3.7500	76.200 3.0000	481000 108000	0.36	1.86	2.78	71600 16100	44400 9980	125000 28000	1.61
69.850 2.7500	152.400 6.0000	95.250 3.7500	76.200 3.0000	430000 96700	0.41	1.65	2.46	64000 14400	44800 10100	112000 25100	1.43
69.850 2.7500	155.575 6.1250	101.600 4.0000	85.725 3.3750	553000 124000	0.33	2.08	3.09	82400 18500	45900 10300	143000 32200	1.80
69.850 2.7500	155.575 6.1250	101.600 4.0000	85.725 3.3750	656000 147000	0.33	2.08	3.09	97600 21900	54400 12200	170000 38200	1.80
69.850 2.7500	171.450 6.7500	125.412 4.9375	100.012 3.9375	844000 190000	0.30	2.26	3.36	126000 28300	64400 14500	219000 49200	1.95
69.914 2.7525	177.800 7.0000	109.538 4.3125	74.612 2.9375	632000 142000	0.76	0.88	1.31	94100 21200	123000 27700	164000 36800	0.76

<sup>(1)</sup>Based on 1 x 10<sup>6</sup> revolutions L<sub>10</sub> life, for the ISO life-calculation method. C<sub>1(2)</sub> is the double-row radial value.

<sup>(2)</sup>Consult your Timken engineer for instructions on use or review the Timken Engineering Manual on [timken.com/catalogs](http://timken.com/catalogs).

<sup>(3)</sup>Based on 90 x 10<sup>6</sup> revolutions L<sub>10</sub> life, for The Timken Company life-calculation method. C<sub>90</sub> and C<sub>a90</sub> are radial and thrust values for a single row. C<sub>90(2)</sub> is the double-row radial value.

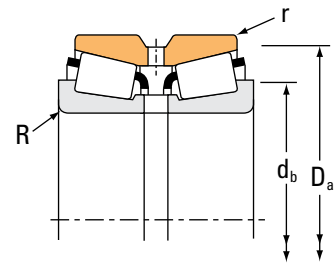
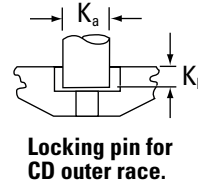
Part Number		Dimensions						Geometry Factors			Bearing Weight
Inner	Outer	Shaft		Housing		Pin		G <sub>1</sub>	G <sub>2</sub>	C <sub>G</sub>	
		Max. Shaft Fillet Radius R <sup>(4)</sup>	Backing Shoulder Dia. d <sub>b</sub>	Max. Housing Fillet Radius r <sup>(4)</sup>	Backing Shoulder Dia. D <sub>a</sub>	K <sub>a</sub>	K <sub>b</sub>				
		mm in.	mm in.	mm in.	mm in.	mm in.	mm in.				kg lbs.
399AS	394D	5.0 0.20	83.0 3.27	0.8 0.03	104.4 4.11	– –	– –	56.0	21.4	0.0984	1.65 3.64
480	472D	3.5 0.14	82.0 3.23	0.8 0.03	114.0 4.49	– –	– –	77.2	23.0	0.1083	2.98 6.58
560-S	552D	3.5 0.14	83.0 3.27	1.5 0.06	115.0 4.53	– –	– –	91.0	21.1	0.1108	3.79 8.35
570	563D	3.5 0.14	83.0 3.27	1.5 0.06	119.0 4.69	– –	– –	101.3	24.0	0.1167	4.23 9.31
642	632D	3.5 0.14	85.0 3.35	1.5 0.06	125.0 4.92	– –	– –	106.4	21.0	0.0814	5.93 13.04
9278	9220D	3.5 0.14	106.0 4.17	0.8 0.03	153.0 6.03	– –	– –	102.5	16.1	0.0984	9.42 20.77
29675	29622D	1.5 0.06	80.0 3.15	0.8 0.03	109.0 4.29	– –	– –	77.7	43.3	0.1170	2.20 4.86
33275	33462D	3.5 0.14	85.0 3.35	0.8 0.03	112.0 4.41	– –	– –	84.2	25.9	0.1162	2.81 6.20
482	472D	3.5 0.14	83.0 3.27	0.8 0.03	114.0 4.49	– –	– –	77.2	23.0	0.1083	2.90 6.40
47487	47420D	3.5 0.14	84.0 3.31	0.8 0.03	114.0 4.49	– –	– –	98.4	26.3	0.1153	3.12 6.86
566	563D	3.5 0.14	85.0 3.35	1.5 0.06	119.0 4.69	– –	– –	101.3	24.0	0.1167	4.12 9.07
643	632D	3.5 0.14	86.0 3.39	1.5 0.06	125.0 4.92	– –	– –	106.4	21.0	0.0814	5.78 12.73
655	654D	3.5 0.14	88.0 3.46	1.5 0.06	141.0 5.55	– –	– –	136.6	27.3	0.0919	8.08 17.84
744A	742D	5.0 0.20	91.0 3.58	1.5 0.06	143.0 5.63	– –	– –	159.6	26.3	0.0898	9.32 20.54
745A	742D	3.5 0.14	88.0 3.46	1.5 0.06	143.0 5.63	– –	– –	159.6	26.3	0.0898	9.35 20.61
835	834D	3.5 0.14	91.0 3.58	0.8 0.03	155.0 6.10	– –	– –	197.9	34.8	0.0937	14.37 31.68
9382	9320D	3.5 0.14	101.0 3.98	2.3 0.09	164.0 6.46	– –	– –	117.9	18.6	0.1053	12.79 28.19

<sup>(4)</sup>These maximum fillet radii will be cleared by bearing corners.  
NOTE: For spacer configuration information, contact your Timken engineer.

# TAPERED ROLLER BEARINGS

## DOUBLE-ROW • TYPE TDO

### TYPE TDO



Bearing Dimensions				Load Ratings							
Bore d	O.D. D	Width T	Double Outer Ring Width C	Dynamic <sup>(1)</sup>				Dynamic <sup>(3)</sup>			
				C <sub>1(2)</sub>	e	Y <sub>1</sub>	Y <sub>2</sub>	C <sub>90</sub>	C <sub>a90</sub>	C <sub>90(2)</sub>	K
mm in.	mm in.	mm in.	mm in.	N lbf				N lbf	N lbf	N lbf	
69.952 2.7540	121.442 4.7812	52.390 2.0626	38.100 1.5000	178000 40000	0.45	1.50	2.23	26500 5960	20500 4600	46100 10400	1.30
70.000 2.7559	120.000 4.7244	65.090 2.5626	53.975 2.1250	250000 56100	0.38	1.75	2.61	37200 8360	24500 5500	64700 14600	1.52
70.637 2.7810	114.287 4.4995	58.738 2.3125	46.038 1.8125	192000 43300	0.49	1.38	2.06	28600 6440	23900 5370	49900 11200	1.20
71.437 2.8125	117.475 4.6250	66.675 2.6250	53.975 2.1250	241000 54200	0.44	1.55	2.31	35900 8060	26800 6020	62400 14000	1.34
71.437 2.8125	120.000 4.7244	71.438 2.8125	58.738 2.3125	311000 70000	0.36	1.87	2.79	46300 10400	28600 6420	80700 18100	1.62
71.437 2.8125	127.000 5.0000	80.962 3.1875	65.088 2.5625	342000 76900	0.36	1.86	2.76	50900 11400	31700 7130	88600 19900	1.61
71.437 2.8125	127.000 5.0000	80.962 3.1875	65.088 2.5625	342000 76900	0.36	1.86	2.76	50900 11400	31700 7130	88600 19900	1.61
71.437 2.8125	136.525 5.3750	69.850 2.7500	53.975 2.1250	269000 60500	0.44	1.52	2.26	40000 9000	30500 6850	69700 15700	1.31
71.437 2.8125	136.525 5.3750	95.250 3.7500	76.200 3.0000	481000 108000	0.36	1.86	2.78	71600 16100	44400 9980	125000 28000	1.61
71.437 2.8125	136.525 5.3750	95.250 3.7500	76.200 3.0000	481000 108000	0.36	1.86	2.78	71600 16100	44400 9980	125000 28000	1.61
73.025 2.8750	114.287 4.4995	58.738 2.3125	46.038 1.8125	192000 43300	0.49	1.38	2.06	28600 6440	23900 5370	49900 11200	1.20
73.025 2.8750	117.475 4.6250	66.675 2.6250	53.975 2.1250	241000 54200	0.44	1.55	2.31	35900 8060	26800 6020	62400 14000	1.34
73.025 2.8750	127.000 5.0000	80.962 3.1875	65.088 2.5625	342000 76900	0.36	1.86	2.76	50900 11400	31700 7130	88600 19900	1.61
73.025 2.8750	127.000 5.0000	80.962 3.1875	65.088 2.5625	342000 76900	0.36	1.86	2.76	50900 11400	31700 7130	88600 19900	1.61
73.025 2.8750	139.992 5.5115	82.550 3.2500	66.675 2.6250	360000 80900	0.40	1.67	2.49	53600 12100	37100 8330	93400 21000	1.45
73.025 2.8750	152.400 6.0000	95.250 3.7500	76.200 3.0000	430000 96700	0.41	1.65	2.46	64000 14400	44800 10100	112000 25100	1.43
73.025 2.8750	155.575 6.1250	101.600 4.0000	85.725 3.3750	656000 147000	0.33	2.08	3.09	97600 21900	54400 12200	170000 38200	1.80

<sup>(1)</sup>Based on 1 x 10<sup>6</sup> revolutions L<sub>10</sub> life, for the ISO life-calculation method. C<sub>1(2)</sub> is the double-row radial value.

<sup>(2)</sup>Consult your Timken engineer for instructions on use or review the Timken Engineering Manual on [timken.com/catalogs](http://timken.com/catalogs).

<sup>(3)</sup>Based on 90 x 10<sup>6</sup> revolutions L<sub>10</sub> life, for The Timken Company life-calculation method. C<sub>90</sub> and C<sub>a90</sub> are radial and thrust values for a single row. C<sub>90(2)</sub> is the double-row radial value.

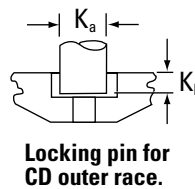
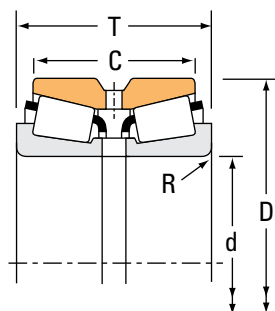
Part Number		Dimensions						Geometry Factors			Bearing Weight
Inner	Outer	Shaft		Housing		Pin		G <sub>1</sub>	G <sub>2</sub>	C <sub>G</sub>	
		Max. Shaft Fillet Radius R <sup>(4)</sup>	Backing Shoulder Dia. d <sub>b</sub>	Max. Housing Fillet Radius r <sup>(4)</sup>	Backing Shoulder Dia. D <sub>a</sub>	K <sub>a</sub>	K <sub>b</sub>				
		mm in.	mm in.	mm in.	mm in.	mm in.	mm in.				kg lbs.
34274	34478D	2.0 0.08	81.0 3.19	0.8 0.03	116.0 4.57	– –	– –	69.3	27.0	0.1093	2.27 4.99
484	472D	2.0 0.08	80.0 3.15	0.8 0.03	114.0 4.49	– –	– –	77.2	23.0	0.1083	2.93 6.44
29680	29622D	1.3 0.05	80.0 3.15	0.8 0.03	109.0 4.29	– –	– –	77.7	43.3	0.1170	2.18 4.82
33281	33462D	3.5 0.14	87.0 3.43	0.8 0.03	112.0 4.41	– –	– –	84.2	25.9	0.1162	2.73 6.02
47490	47420D	3.5 0.14	86.0 3.39	0.8 0.03	114.0 4.49	– –	– –	98.4	26.3	0.1153	3.01 6.65
567A	563D	3.5 0.14	86.0 3.39	1.5 0.06	119.0 4.69	– –	– –	101.3	24.0	0.1167	4.02 8.86
567-S	563D	6.4 0.25	92.0 3.62	1.5 0.06	119.0 4.69	– –	– –	101.3	24.0	0.1167	3.96 8.75
495-S	493D	3.5 0.14	88.0 3.46	0.8 0.03	130.0 5.12	– –	– –	104.6	29.3	0.1252	4.41 9.70
644	632D	3.5 0.14	87.0 3.43	1.5 0.06	125.0 4.92	– –	– –	106.4	21.0	0.0814	5.70 12.56
645	632D	6.4 0.25	93.0 3.66	1.5 0.06	125.0 4.92	– –	– –	106.4	21.0	0.0814	5.64 12.40
29685	29622D	3.5 0.14	86.0 3.39	0.8 0.03	109.0 4.29	– –	– –	77.7	43.3	0.1170	2.06 4.53
33287	33462D	3.5 0.14	88.0 3.46	0.8 0.03	112.0 4.41	– –	– –	84.2	25.9	0.1162	2.64 5.81
567	563D	3.5 0.14	88.0 3.46	1.5 0.06	119.0 4.69	– –	– –	101.3	24.0	0.1167	3.90 8.59
567X	563D	4.8 0.19	90.0 3.54	1.5 0.06	119.0 4.69	– –	– –	101.3	24.0	0.1167	3.92 8.66
576	572D	3.5 0.14	90.0 3.54	0.8 0.03	133.0 5.24	– –	– –	125.7	32.0	0.1295	5.47 12.05
657	654D	3.5 0.14	91.0 3.58	1.5 0.06	141.0 5.55	– –	– –	136.6	27.3	0.0919	7.81 17.23
744	742D	3.5 0.14	91.0 3.58	1.5 0.06	143.0 5.63	– –	– –	159.6	26.3	0.0898	9.03 19.90

<sup>(4)</sup>These maximum fillet radii will be cleared by bearing corners.  
NOTE: For spacer configuration information, contact your Timken engineer.

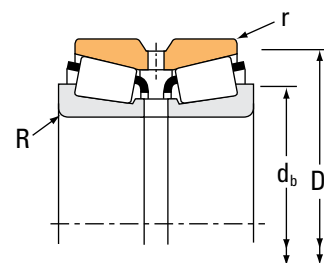
# TAPERED ROLLER BEARINGS

## DOUBLE-ROW • TYPE TDO

### TYPE TDO



Locking pin for CD outer race.



Bearing Dimensions				Load Ratings							
Bore d	O.D. D	Width T	Double Outer Ring Width C	Dynamic <sup>(1)</sup>				Dynamic <sup>(3)</sup>			
				C <sub>1(2)</sub>	e	Y <sub>1</sub>	Y <sub>2</sub>	C <sub>90</sub>	C <sub>a90</sub>	C <sub>90(2)</sub>	K
mm in.	mm in.	mm in.	mm in.	N lbf				N lbf	N lbf	N lbf	
73.817 2.9062	114.287 4.4995	58.738 2.3125	46.038 1.8125	192000 43300	0.49	1.38	2.06	28600 6440	23900 5370	49900 11200	1.20
73.817 2.9062	127.000 5.0000	80.962 3.1875	65.088 2.5625	342000 76900	0.36	1.86	2.76	50900 11400	31700 7130	88600 19900	1.61
74.612 2.9375	139.992 5.5115	82.550 3.2500	66.675 2.6250	360000 80900	0.40	1.67	2.49	53600 12100	37100 8330	93400 21000	1.45
74.976 2.9518	121.442 4.7812	52.390 2.0626	38.100 1.5000	178000 40000	0.45	1.50	2.23	26500 5960	20500 4600	46100 10400	1.30
76.200 3.0000	109.538 4.3125	42.860 1.6874	34.925 1.3750	120000 27100	0.50	1.34	2.00	17900 4030	15400 3470	31200 7020	1.16
76.200 3.0000	121.442 4.7812	52.390 2.0626	38.100 1.5000	178000 40000	0.45	1.50	2.23	26500 5960	20500 4600	46100 10400	1.30
76.200 3.0000	121.442 4.7812	52.390 2.0626	38.100 1.5000	178000 40000	0.45	1.50	2.23	26500 5960	20500 4600	46100 10400	1.30
76.200 3.0000	136.525 5.3750	69.850 2.7500	53.975 2.1250	269000 60500	0.44	1.52	2.26	40000 9000	30500 6850	69700 15700	1.31
76.200 3.0000	139.992 5.5115	82.550 3.2500	66.675 2.6250	360000 80900	0.40	1.67	2.49	53600 12100	37100 8330	93400 21000	1.45
76.200 3.0000	152.400 6.0000	82.550 3.2500	63.500 2.5000	376000 84600	0.44	1.53	2.27	56000 12600	42400 9530	97500 21900	1.32
76.200 3.0000	152.400 6.0000	95.250 3.7500	76.200 3.0000	430000 96700	0.41	1.65	2.46	64000 14400	44800 10100	112000 25100	1.43
76.200 3.0000	155.575 6.1250	101.600 4.0000	85.725 3.3750	656000 147000	0.33	2.08	3.09	97600 21900	54400 12200	170000 38200	1.80
76.200 3.0000	161.925 6.3750	104.775 4.1250	85.725 3.3750	570000 128000	0.34	1.98	2.95	84800 19100	49500 11100	148000 33200	1.71
76.200 3.0000	161.925 6.3750	105.562 4.1560	70.637 2.7810	614000 138000	0.71	0.95	1.42	91400 20600	111000 24900	159000 35800	0.82
76.200 3.0000	171.450 6.7500	125.412 4.9375	100.012 3.9375	844000 190000	0.30	2.26	3.36	126000 28300	64400 14500	219000 49200	1.95
76.200 3.0000	171.450 6.7500	125.412 4.9375	100.012 3.9375	844000 190000	0.30	2.26	3.36	126000 28300	64400 14500	219000 49200	1.95
76.200 3.0000	177.800 7.0000	109.538 4.3125	74.612 2.9375	632000 142000	0.76	0.88	1.31	94100 21200	123000 27700	164000 36800	0.76

<sup>(1)</sup>Based on 1 x 10<sup>6</sup> revolutions L<sub>10</sub> life, for the ISO life-calculation method. C<sub>1(2)</sub> is the double-row radial value.

<sup>(2)</sup>Consult your Timken engineer for instructions on use or review the Timken Engineering Manual on [timken.com/catalogs](http://timken.com/catalogs).

<sup>(3)</sup>Based on 90 x 10<sup>6</sup> revolutions L<sub>10</sub> life, for The Timken Company life-calculation method. C<sub>90</sub> and C<sub>a90</sub> are radial and thrust values for a single row. C<sub>90(2)</sub> is the double-row radial value.

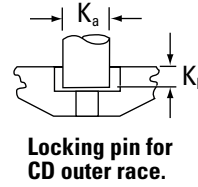
Part Number		Dimensions						Geometry Factors			Bearing Weight
Inner	Outer	Shaft		Housing		Pin		G <sub>1</sub>	G <sub>2</sub>	C <sub>G</sub>	
		Max. Shaft Fillet Radius R <sup>(4)</sup>	Backing Shoulder Dia. d <sub>b</sub>	Max. Housing Fillet Radius r <sup>(4)</sup>	Backing Shoulder Dia. D <sub>a</sub>	K <sub>a</sub>	K <sub>b</sub>				
		mm in.	mm in.	mm in.	mm in.	mm in.	mm in.				kg lbs.
29688	29622D	1.5 0.06	83.0 3.27	0.8 0.03	109.0 4.29	– –	– –	77.7	43.3	0.1170	2.04 4.49
568	563D	0.8 0.03	83.0 3.27	1.5 0.06	119.0 4.69	– –	– –	101.3	24.0	0.1167	3.86 8.53
577	572D	3.5 0.14	91.0 3.58	0.8 0.03	133.0 5.24	– –	– –	125.7	32.0	0.1295	5.41 11.91
34294	34478D	2.0 0.08	85.0 3.35	0.8 0.03	116.0 4.57	– –	– –	69.3	27.0	0.1093	2.02 4.47
L814749	L814710D	1.5 0.06	84.0 3.31	0.8 0.03	105.0 4.13	– –	– –	76.0	58.3	0.1164	1.26 2.78
34300	34478D	2.0 0.08	86.0 3.39	0.8 0.03	116.0 4.57	– –	– –	69.3	27.0	0.1093	1.98 4.37
34301	34478D	3.5 0.14	89.0 3.50	0.8 0.03	116.0 4.57	– –	– –	69.3	27.0	0.1093	1.96 4.32
495A	493D	3.5 0.14	92.0 3.62	0.8 0.03	130.0 5.12	– –	– –	104.6	29.3	0.1252	4.04 8.90
575	572D	3.5 0.14	92.0 3.62	0.8 0.03	133.0 5.24	– –	– –	125.7	32.0	0.1295	5.23 11.53
590A	592D	3.5 0.14	95.0 3.74	0.8 0.03	144.0 5.67	– –	– –	151.4	38.3	0.1416	6.78 14.94
659	654D	3.5 0.14	93.0 3.66	1.5 0.06	141.0 5.55	– –	– –	136.6	27.3	0.0919	7.54 16.63
748-S	742D	3.5 0.14	93.0 3.66	1.5 0.06	143.0 5.63	– –	– –	159.6	26.3	0.0898	8.73 19.25
755	752D	3.5 0.14	98.0 3.86	1.5 0.06	150.0 5.91	– –	– –	177.2	29.4	0.0945	10.04 22.12
9285	9220D	3.5 0.14	111.0 4.37	0.8 0.03	153.0 6.03	– –	– –	102.5	16.1	0.0984	8.66 19.11
837	834D	0.8 0.03	90.0 3.54	0.8 0.03	155.0 6.10	– –	– –	197.9	34.8	0.0937	13.63 30.04
843	834D	6.4 0.25	101.0 3.98	0.8 0.03	155.0 6.10	– –	– –	197.9	34.8	0.0937	13.59 29.96
9380	9320D	3.5 0.14	105.0 4.13	2.3 0.09	164.0 6.46	– –	– –	117.9	18.6	0.1053	12.16 26.80

<sup>(4)</sup>These maximum fillet radii will be cleared by bearing corners.  
NOTE: For spacer configuration information, contact your Timken engineer.

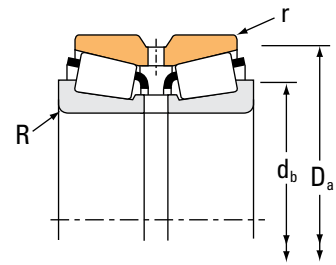
# TAPERED ROLLER BEARINGS

## DOUBLE-ROW • TYPE TDO

### TYPE TDO



Locking pin for CD outer race.



Bearing Dimensions				Load Ratings							
Bore d	O.D. D	Width T	Double Outer Ring Width C	Dynamic <sup>(1)</sup>				Dynamic <sup>(3)</sup>			
				C <sub>1(2)</sub>	e	Y <sub>1</sub>	Y <sub>2</sub>	C <sub>90</sub>	C <sub>a90</sub>	C <sub>90(2)</sub>	K
mm in.	mm in.	mm in.	mm in.	N lbf				N lbf	N lbf	N lbf	
76.200 3.0000	177.800 7.0000	115.888 4.5625	74.612 2.9375	632000 142000	0.76	0.88	1.31	94100 21200	123000 27700	164000 36800	0.76
76.200 3.0000	190.500 7.5000	127.000 5.0000	104.775 4.1250	929000 209000	0.33	2.02	3.00	138000 31100	79300 17800	241000 54200	1.74
77.788 3.0625	121.442 4.7812	52.390 2.0626	38.100 1.5000	211000 47400	0.45	1.50	2.23	31400 7060	24200 5450	54700 12300	1.30
77.788 3.0625	136.525 5.3750	69.850 2.7500	53.975 2.1250	269000 60500	0.44	1.52	2.26	40000 9000	30500 6850	69700 15700	1.31
79.375 3.1250	152.400 6.0000	82.550 3.2500	63.500 2.5000	376000 84600	0.44	1.53	2.27	56000 12600	42400 9530	97500 21900	1.32
79.985 3.1490	139.992 5.5115	82.550 3.2500	66.675 2.6250	360000 80900	0.40	1.67	2.49	53600 12100	37100 8330	93400 21000	1.45
79.985 3.1490	152.400 6.0000	82.550 3.2500	63.500 2.5000	376000 84600	0.44	1.53	2.27	56000 12600	42400 9530	97500 21900	1.32
80.000 3.1496	155.575 6.1250	101.600 4.0000	85.725 3.3750	553000 124000	0.33	2.08	3.09	82400 18500	45900 10300	143000 32200	1.80
80.000 3.1496	200.025 7.8750	108.268 4.5625	80.216 3.1581	839000 189000	0.63	1.07	1.59	125000 28100	135000 30400	217000 48900	0.92
80.962 3.1875	136.525 5.3750	69.850 2.7500	53.975 2.1250	269000 60500	0.44	1.52	2.26	40000 9000	30500 6850	69700 15700	1.31
80.962 3.1875	139.992 5.5115	82.550 3.2500	66.675 2.6250	360000 80900	0.40	1.67	2.49	53600 12100	37100 8330	93400 21000	1.45
80.962 3.1875	152.400 6.0000	88.900 3.5000	76.200 3.0000	430000 96700	0.41	1.65	2.46	64000 14400	44800 10100	112000 25100	1.43
82.550 3.2500	115.888 4.5625	47.625 1.8750	39.690 1.5626	157000 35300	0.31	2.19	3.26	23400 5260	12300 2770	40700 9150	1.90
82.550 3.2500	136.525 5.3750	69.850 2.7500	53.975 2.1250	269000 60500	0.44	1.52	2.26	40000 9000	30500 6850	69700 15700	1.31
82.550 3.2500	139.992 5.5115	82.550 3.2500	66.675 2.6250	360000 80900	0.40	1.67	2.49	53600 12100	37100 8330	93400 21000	1.45
82.550 3.2500	139.992 5.5115	82.550 3.2500	66.675 2.6250	360000 80900	0.40	1.67	2.49	53600 12100	37100 8330	93400 21000	1.45
82.550 3.2500	152.400 6.0000	82.550 3.2500	63.500 2.5000	376000 84600	0.44	1.53	2.27	56000 12600	42400 9530	97500 21900	1.32

<sup>(1)</sup>Based on  $1 \times 10^6$  revolutions  $L_{10}$  life, for the ISO life-calculation method.  $C_{1(2)}$  is the double-row radial value.

<sup>(2)</sup>Consult your Timken engineer for instructions on use or review the Timken Engineering Manual on [timken.com/catalogs](http://timken.com/catalogs).

<sup>(3)</sup>Based on  $90 \times 10^6$  revolutions  $L_{10}$  life, for The Timken Company life-calculation method.  $C_{90}$  and  $C_{a90}$  are radial and thrust values for a single row.  $C_{90(2)}$  is the double-row radial value.



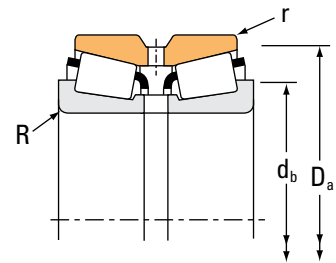
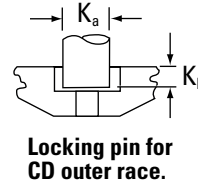
Part Number		Dimensions						Geometry Factors			Bearing Weight
Inner	Outer	Shaft		Housing		Pin		G <sub>1</sub>	G <sub>2</sub>	C <sub>g</sub>	
		Max. Shaft Fillet Radius R <sup>(4)</sup>	Backing Shoulder Dia. d <sub>b</sub>	Max. Housing Fillet Radius r <sup>(4)</sup>	Backing Shoulder Dia. D <sub>a</sub>	K <sub>a</sub>	K <sub>b</sub>				
		mm in.	mm in.	mm in.	mm in.	mm in.	mm in.				kg lbs.
9378	9320D	3.5 0.14	105.0 4.13	2.3 0.09	164.0 6.46	– –	– –	117.9	18.6	0.1053	12.68 27.98
HH221430	HH221410D	3.5 0.14	101.0 3.98	1.5 0.06	179.0 7.05	– –	– –	265.6	28.4	0.1072	18.09 39.85
34306	34478D	3.5 0.14	91.0 3.58	0.8 0.03	116.0 4.57	– –	– –	69.3	27.0	0.1093	1.86 4.11
495AS	493D	3.5 0.14	93.0 3.66	0.8 0.03	130.0 5.12	– –	– –	104.6	29.3	0.1252	3.99 8.80
595A	592D	3.5 0.14	98.0 3.86	0.8 0.03	144.0 5.67	– –	– –	151.4	38.3	0.1416	6.51 14.35
578	572D	3.5 0.14	95.0 3.74	0.8 0.03	133.0 5.24	– –	– –	125.7	32.0	0.1295	3.52 7.76
590	592D	3.5 0.14	98.0 3.86	0.8 0.03	144.0 5.67	– –	– –	151.4	38.3	0.1416	4.48 9.87
748	742D	3.0 0.12	96.0 3.78	1.5 0.06	143.0 5.63	– –	– –	159.6	26.3	0.0898	8.38 18.45
98316	98789D	3.5 0.14	111.0 4.37	2.3 0.09	188.0 7.40	– –	– –	203.4	37.5	0.1197	17.28 38.11
496	493D	3.5 0.14	95.0 3.74	0.8 0.03	130.0 5.12	– –	– –	104.6	29.3	0.1252	3.74 8.23
581	572D	3.5 0.14	96.0 3.78	0.8 0.03	133.0 5.24	– –	– –	125.7	32.0	0.1295	4.88 10.75
662	654D	3.5 0.14	98.0 3.86	1.5 0.06	141.0 5.55	– –	– –	136.6	27.3	0.0919	6.77 14.96
L116149	L116110D	1.5 0.06	90.0 3.54	0.8 0.03	111.0 4.37	– –	– –	97.2	64.3	0.1079	0.98 2.17
495	493D	3.5 0.14	97.0 3.82	0.8 0.03	130.0 5.12	– –	– –	104.6	29.3	0.1252	3.63 8.00
580	572D	3.5 0.14	98.0 3.86	0.8 0.03	133.0 5.24	– –	– –	125.7	32.0	0.1295	4.74 10.47
582	572D	6.8 0.27	104.0 4.09	0.8 0.03	133.0 5.24	– –	– –	125.7	32.0	0.1295	4.69 10.33
595	592D	3.5 0.14	100.0 3.94	0.8 0.03	144.0 5.67	– –	– –	151.4	38.3	0.1416	6.26 13.80

<sup>(4)</sup>These maximum fillet radii will be cleared by bearing corners.  
NOTE: For spacer configuration information, contact your Timken engineer.

# TAPERED ROLLER BEARINGS

## DOUBLE-ROW • TYPE TDO

### TYPE TDO



Bearing Dimensions				Load Ratings							
Bore d	O.D. D	Width T	Double Outer Ring Width C	Dynamic <sup>(1)</sup>				Dynamic <sup>(3)</sup>			
				C <sub>1(2)</sub>	e	Y <sub>1</sub>	Y <sub>2</sub>	C <sub>90</sub>	C <sub>a90</sub>	C <sub>90(2)</sub>	K
mm in.	mm in.	mm in.	mm in.	N lbf				N lbf	N lbf	N lbf	
82.550 3.2500	152.400 6.0000	95.250 3.7500	76.200 3.0000	430000 96700	0.41	1.65	2.46	64000 14400	44800 10100	112000 25100	1.43
82.550 3.2500	155.575 6.1250	101.600 4.0000	85.725 3.3750	656000 147000	0.33	2.08	3.09	97600 21900	54400 12200	170000 38200	1.80
82.550 3.2500	161.925 6.3750	104.775 4.1250	85.725 3.3750	570000 128000	0.34	1.98	2.95	84800 19100	49500 11100	148000 33200	1.71
82.550 3.2500	171.450 6.7500	125.412 4.9375	100.012 3.9375	844000 190000	0.30	2.26	3.36	126000 28300	64400 14500	219000 49200	1.95
84.138 3.3125	136.525 5.3750	69.850 2.7500	53.975 2.1250	269000 60500	0.44	1.52	2.26	40000 9000	30500 6850	69700 15700	1.31
84.138 3.3125	152.400 6.0000	95.250 3.7500	76.200 3.0000	430000 96700	0.41	1.65	2.46	64000 14400	44800 10100	112000 25100	1.43
84.138 3.3125	177.800 7.0000	109.538 4.3125	74.612 2.9375	632000 142000	0.76	0.88	1.31	94100 21200	123000 27700	164000 36800	0.76
85.000 3.3465	200.025 7.8750	108.268 4.5625	80.216 3.1581	839000 189000	0.63	1.07	1.59	125000 28100	135000 30400	217000 48900	0.92
85.025 3.3475	155.575 6.1250	101.600 4.0000	85.725 3.3750	656000 147000	0.33	2.08	3.09	97600 21900	54400 12200	170000 38200	1.80
85.725 3.3750	136.525 5.3750	69.850 2.7500	53.975 2.1250	269000 60500	0.44	1.52	2.26	40000 9000	30500 6850	69700 15700	1.31
85.725 3.3750	152.400 6.0000	82.550 3.2500	63.500 2.5000	376000 84600	0.44	1.53	2.27	56000 12600	42400 9530	97500 21900	1.32
85.725 3.3750	152.400 6.0000	95.250 3.7500	76.200 3.0000	430000 96700	0.41	1.65	2.46	64000 14400	44800 10100	112000 25100	1.43
85.725 3.3750	161.925 6.3750	104.775 4.1250	85.725 3.3750	570000 128000	0.34	1.98	2.95	84800 19100	49500 11100	148000 33200	1.71
85.725 3.3750	168.275 6.6250	92.075 3.6250	69.850 2.7500	461000 104000	0.47	1.43	2.14	68600 15400	55300 12400	119000 26900	1.24
85.725 3.3750	171.450 6.7500	125.412 4.9375	100.012 3.9375	844000 190000	0.30	2.26	3.36	126000 28300	64400 14500	219000 49200	1.95
87.312 3.4375	123.825 4.8750	50.797 1.9999	42.862 1.6875	161000 36300	0.33	2.05	3.05	24000 5400	13600 3050	41800 9400	1.77
87.312 3.4375	152.400 6.0000	82.550 3.2500	63.500 2.5000	376000 84600	0.44	1.53	2.27	56000 12600	42400 9530	97500 21900	1.32

<sup>(1)</sup>Based on 1 x 10<sup>6</sup> revolutions L<sub>10</sub> life, for the ISO life-calculation method. C<sub>1(2)</sub> is the double-row radial value.

<sup>(2)</sup>Consult your Timken engineer for instructions on use or review the Timken Engineering Manual on [timken.com/catalogs](http://timken.com/catalogs).

<sup>(3)</sup>Based on 90 x 10<sup>6</sup> revolutions L<sub>10</sub> life, for The Timken Company life-calculation method. C<sub>90</sub> and C<sub>a90</sub> are radial and thrust values for a single row. C<sub>90(2)</sub> is the double-row radial value.

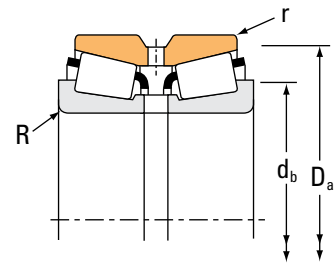
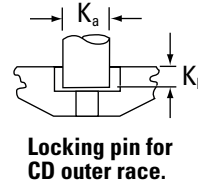
Part Number		Dimensions						Geometry Factors			Bearing Weight
Inner	Outer	Shaft		Housing		Pin		G <sub>1</sub>	G <sub>2</sub>	C <sub>G</sub>	
		Max. Shaft Fillet Radius R <sup>(4)</sup>	Backing Shoulder Dia. d <sub>b</sub>	Max. Housing Fillet Radius r <sup>(4)</sup>	Backing Shoulder Dia. D <sub>a</sub>	K <sub>a</sub>	K <sub>b</sub>				
		mm in.	mm in.	mm in.	mm in.	mm in.	mm in.				kg lbs.
663	654D	3.5 0.14	99.0 3.90	1.5 0.06	141.0 5.55	– –	– –	136.6	27.3	0.0919	6.94 15.32
749A	742D	3.5 0.14	99.0 3.90	1.5 0.06	143.0 5.63	– –	– –	159.6	26.3	0.0898	8.10 17.88
757	752D	3.5 0.14	100.0 3.94	1.5 0.06	150.0 5.91	– –	– –	177.2	29.4	0.0945	9.43 20.80
842	834D	3.5 0.14	101.0 3.98	0.8 0.03	155.0 6.10	– –	– –	197.9	34.8	0.0937	13.02 28.73
498	493D	3.5 0.14	98.0 3.86	0.8 0.03	130.0 5.12	– –	– –	104.6	29.3	0.1252	3.53 7.79
664	654D	3.5 0.14	100.0 3.94	1.5 0.06	141.0 5.55	– –	– –	136.6	27.3	0.0919	6.82 15.02
9386H	9320D	3.5 0.14	111.0 4.37	2.3 0.09	164.0 6.46	– –	– –	117.9	18.6	0.1053	11.07 24.39
98335	98789D	3.5 0.14	115.0 4.53	2.3 0.09	188.0 7.40	– –	– –	203.4	37.5	0.1197	16.86 37.17
749	742D	3.5 0.14	101.0 3.98	1.5 0.06	143.0 5.63	– –	– –	159.6	26.3	0.0898	7.89 17.38
497	493D	3.5 0.14	99.0 3.90	0.8 0.03	130.0 5.12	– –	– –	104.6	29.3	0.1252	3.42 7.56
596	592D	3.5 0.14	102.0 4.02	0.8 0.03	144.0 5.67	– –	– –	151.4	38.3	0.1416	6.07 13.39
665	654D	3.5 0.14	102.0 4.02	1.5 0.06	141.0 5.55	– –	– –	136.6	27.3	0.0919	6.67 14.72
758	752D	3.5 0.14	106.0 4.17	1.5 0.06	150.0 5.91	– –	– –	177.2	29.4	0.0945	9.08 20.02
677	672D	3.5 0.14	105.0 4.13	0.8 0.03	160.0 6.30	– –	– –	182.5	37.3	0.1056	9.18 20.23
841	834D	3.5 0.14	104.0 4.09	0.8 0.03	155.0 6.10	– –	– –	197.9	34.8	0.0937	12.58 27.73
L217847	L217810D	1.5 0.06	96.0 3.78	0.8 0.03	119.0 4.69	– –	– –	111.3	74.8	0.1152	1.79 3.92
596-S	592D	3.5 0.14	103.0 4.06	0.8 0.03	144.0 5.67	– –	– –	151.4	38.3	0.1416	5.96 13.13

<sup>(4)</sup>These maximum fillet radii will be cleared by bearing corners.  
NOTE: For spacer configuration information, contact your Timken engineer.

# TAPERED ROLLER BEARINGS

## DOUBLE-ROW • TYPE TDO

### TYPE TDO



Bearing Dimensions				Load Ratings							
Bore d	O.D. D	Width T	Double Outer Ring Width C	Dynamic <sup>(1)</sup>				Dynamic <sup>(3)</sup>			
				C <sub>1(2)</sub>	e	Y <sub>1</sub>	Y <sub>2</sub>	C <sub>90</sub>	C <sub>a90</sub>	C <sub>90(2)</sub>	K
mm in.	mm in.	mm in.	mm in.	N lbf				N lbf	N lbf	N lbf	
87.312 3.4375	190.500 7.5000	127.000 5.0000	104.775 4.1250	929000 209000	0.33	2.02	3.00	138000 31100	79300 17800	241000 54200	1.74
87.960 3.4630	149.225 5.8750	66.672 2.6249	52.388 2.0625	336000 75600	0.49	1.37	2.04	50100 11300	42200 9480	87100 19600	1.19
88.900 3.5000	123.825 4.8750	50.797 1.9999	42.862 1.6875	161000 36300	0.33	2.05	3.05	24000 5400	13600 3050	41800 9400	1.77
88.900 3.5000	149.225 5.8750	66.672 2.6249	52.388 2.0625	336000 75600	0.49	1.37	2.04	50100 11300	42200 9480	87100 19600	1.19
88.900 3.5000	152.400 6.0000	82.550 3.2500	63.500 2.5000	376000 84600	0.44	1.53	2.27	56000 12600	42400 9530	97500 21900	1.32
88.900 3.5000	152.400 6.0000	82.550 3.2500	63.500 2.5000	376000 84600	0.44	1.53	2.27	56000 12600	42400 9530	97500 21900	1.32
88.900 3.5000	161.925 6.3750	104.775 4.1250	85.725 3.3750	570000 128000	0.34	1.98	2.95	84800 19100	49500 11100	148000 33200	1.71
88.900 3.5000	168.275 6.6250	92.075 3.6250	69.850 2.7500	461000 104000	0.47	1.43	2.14	68600 15400	55300 12400	119000 26900	1.24
88.900 3.5000	171.450 6.7500	125.412 4.9375	100.012 3.9375	844000 190000	0.30	2.26	3.36	126000 28300	64400 14500	219000 49200	1.95
88.900 3.5000	180.975 7.1250	104.774 4.1250	85.725 3.3750	603000 135000	0.39	1.75	2.61	89700 20200	59200 13300	156000 35100	1.51
88.900 3.5000	190.500 7.5000	127.000 5.0000	101.600 4.0000	797000 179000	0.33	2.02	3.00	119000 26700	68000 15300	207000 46400	1.74
88.900 3.5000	190.500 7.5000	127.000 5.0000	104.775 4.1250	929000 209000	0.33	2.02	3.00	138000 31100	79300 17800	241000 54200	1.74
88.900 3.5000	200.025 7.8750	115.888 4.5625	80.216 3.1581	839000 189000	0.63	1.07	1.59	125000 28100	135000 30400	217000 48900	0.92
89.891 3.5390	171.450 6.7500	125.412 4.9375	100.012 3.9375	712000 160000	0.30	2.26	3.36	106000 23800	54300 12200	185000 41500	1.95
89.916 3.5400	189.967 7.4790	85.852 3.3800	54.102 2.1300	499000 112000	0.87	0.78	1.16	74300 16700	110000 24800	129000 29100	0.67
89.980 3.5425	161.900 6.3740	69.850 2.7500	44.450 1.7500	354000 79500	0.73	0.92	1.37	52600 11800	65900 14800	91700 20600	0.80
90.488 3.5625	161.925 6.3750	104.775 4.1250	85.725 3.3750	570000 128000	0.34	1.98	2.95	84800 19100	49500 11100	148000 33200	1.71

<sup>(1)</sup>Based on 1 x 10<sup>6</sup> revolutions L<sub>10</sub> life, for the ISO life-calculation method. C<sub>1(2)</sub> is the double-row radial value.

<sup>(2)</sup>Consult your Timken engineer for instructions on use or review the Timken Engineering Manual on [timken.com/catalogs](http://timken.com/catalogs).

<sup>(3)</sup>Based on 90 x 10<sup>6</sup> revolutions L<sub>10</sub> life, for The Timken Company life-calculation method. C<sub>90</sub> and C<sub>a90</sub> are radial and thrust values for a single row. C<sub>90(2)</sub> is the double-row radial value.

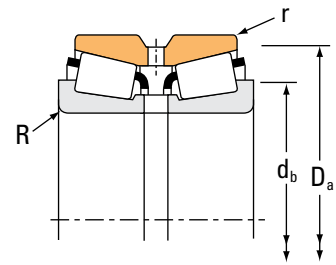
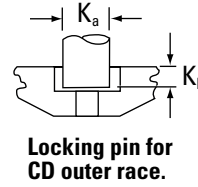
Part Number		Dimensions						Geometry Factors			Bearing Weight
Inner	Outer	Shaft		Housing		Pin		G <sub>1</sub>	G <sub>2</sub>	C <sub>G</sub>	
		Max. Shaft Fillet Radius R <sup>(4)</sup>	Backing Shoulder Dia. d <sub>b</sub>	Max. Housing Fillet Radius r <sup>(4)</sup>	Backing Shoulder Dia. D <sub>a</sub>	K <sub>a</sub>	K <sub>b</sub>				
		mm in.	mm in.	mm in.	mm in.	mm in.	mm in.				kg lbs.
HH221432	HH221410D	8.0 0.31	118.0 4.65	1.5 0.06	179.0 7.05	– –	– –	265.6	28.4	0.1072	16.75 36.90
42346	42587D	3.0 0.12	103.0 4.06	0.8 0.03	143.0 5.63	– –	– –	129.7	37.2	0.1386	4.41 9.73
L217849	L217810D	1.5 0.06	97.0 3.82	0.8 0.03	119.0 4.69	– –	– –	111.3	74.8	0.1152	1.69 3.72
42350	42587D	3.0 0.12	104.0 4.09	0.8 0.03	143.0 5.63	– –	– –	129.7	37.2	0.1386	4.35 9.59
593	592D	3.5 0.14	104.0 4.09	0.8 0.03	144.0 5.67	– –	– –	151.4	38.3	0.1416	5.80 12.79
593A	592D	6.4 0.25	110.0 4.33	0.8 0.03	144.0 5.67	– –	– –	151.4	38.3	0.1416	5.76 12.67
759	752D	3.5 0.14	108.0 4.25	1.5 0.06	150.0 5.91	– –	– –	177.2	29.4	0.0945	8.71 19.18
679	672D	3.5 0.14	107.0 4.21	0.8 0.03	160.0 6.30	– –	– –	182.5	37.3	0.1056	8.82 19.44
850	834D	3.5 0.14	106.0 4.17	0.8 0.03	155.0 6.10	– –	– –	197.9	34.8	0.0937	12.15 26.78
775	774D	4.8 0.19	112.0 4.41	1.5 0.06	168.0 6.61	– –	– –	227.3	41.3	0.1067	12.02 26.52
855	854D	8.0 0.31	118.0 4.65	1.5 0.06	174.0 6.85	– –	– –	264.1	44.9	0.1072	16.69 36.77
HH221434	HH221410D	8.0 0.31	120.0 4.72	1.5 0.06	179.0 7.05	– –	– –	265.6	28.4	0.1072	16.53 36.42
98350	98789D	3.5 0.14	118.0 4.65	2.3 0.09	188.0 7.40	– –	– –	203.4	37.5	0.1197	16.38 36.08
850A	834D	3.5 0.14	107.0 4.21	0.8 0.03	155.0 6.10	– –	– –	197.9	34.8	0.0937	12.07 26.64
HM921343	HM921310D	3.5 0.14	117.0 4.61	1.5 0.06	181.0 7.13	– –	– –	137.2	32.0	0.1143	10.44 23.02
M919048	M919010D	3.5 0.14	109.0 4.29	1.5 0.06	154.0 6.06	– –	– –	102.3	30.7	0.0990	5.40 11.91
760	752D	3.5 0.14	110.0 4.33	1.5 0.06	150.0 5.91	– –	– –	177.2	29.4	0.0945	8.58 18.91

<sup>(4)</sup>These maximum fillet radii will be cleared by bearing corners.  
NOTE: For spacer configuration information, contact your Timken engineer.

# TAPERED ROLLER BEARINGS

## DOUBLE-ROW • TYPE TDO

### TYPE TDO



Bearing Dimensions				Load Ratings							
Bore d	O.D. D	Width T	Double Outer Ring Width C	Dynamic <sup>(1)</sup>		Factors <sup>(2)</sup>		Dynamic <sup>(3)</sup>			Factors <sup>(2)</sup>
				C <sub>1(2)</sub>	e	Y <sub>1</sub>	Y <sub>2</sub>	C <sub>90</sub>	C <sub>a90</sub>	C <sub>90(2)</sub>	K
mm in.	mm in.	mm in.	mm in.	N lbf				N lbf	N lbf	N lbf	
92.075 3.6250	149.225 5.8750	66.672 2.6249	52.388 2.0625	284000 63800	0.49	1.37	2.04	42200 9490	35600 8000	73500 16500	1.19
92.075 3.6250	152.400 6.0000	82.550 3.2500	63.500 2.5000	376000 84600	0.44	1.53	2.27	56000 12600	42400 9530	97500 21900	1.32
92.075 3.6250	152.400 6.0000	82.550 3.2500	63.500 2.5000	376000 84600	0.44	1.53	2.27	56000 12600	42400 9530	97500 21900	1.32
92.075 3.6250	168.275 6.6250	92.075 3.6250	69.850 2.7500	461000 104000	0.47	1.43	2.14	68600 15400	55300 12400	119000 26900	1.24
92.075 3.6250	180.975 7.1250	104.775 4.1250	85.725 3.3750	603000 135000	0.39	1.75	2.61	89700 20200	59200 13300	156000 35100	1.51
93.662 3.6875	149.225 5.8750	66.672 2.6249	52.388 2.0625	336000 75600	0.49	1.37	2.04	50100 11300	42200 9480	87100 19600	1.19
93.662 3.6875	152.400 6.0000	82.550 3.2500	63.500 2.5000	376000 84600	0.44	1.53	2.27	56000 12600	42400 9530	97500 21900	1.32
95.250 3.7500	130.175 5.1250	47.622 1.8749	39.688 1.5625	166000 37300	0.35	1.93	2.88	24700 5560	14800 3320	43100 9680	1.67
95.250 3.7500	136.525 5.3750	68.260 2.6874	57.150 2.2500	243000 54600	0.28	2.38	3.54	36200 8140	17600 3950	63000 14200	2.06
95.250 3.7500	149.225 5.8750	66.672 2.6249	52.388 2.0625	336000 75600	0.49	1.37	2.04	50100 11300	42200 9480	87100 19600	1.19
95.250 3.7500	149.225 5.8750	66.672 2.6249	52.388 2.0625	336000 75600	0.49	1.37	2.04	50100 11300	42200 9480	87100 19600	1.19
95.250 3.7500	152.400 6.0000	82.550 3.2500	63.500 2.5000	376000 84600	0.44	1.53	2.27	56000 12600	42400 9530	97500 21900	1.32
95.250 3.7500	152.400 6.0000	82.550 3.2500	63.500 2.5000	376000 84600	0.44	1.53	2.27	56000 12600	42400 9530	97500 21900	1.32
95.250 3.7500	161.925 6.3750	82.547 3.2499	61.912 2.4375	389000 87500	0.47	1.42	2.12	57900 13000	47100 10600	101000 22700	1.23
95.250 3.7500	168.275 6.6250	92.075 3.6250	69.850 2.7500	461000 104000	0.47	1.43	2.14	68600 15400	55300 12400	119000 26900	1.24
95.250 3.7500	180.975 7.1250	104.775 4.1250	85.725 3.3750	603000 135000	0.39	1.75	2.61	89700 20200	59200 13300	156000 35100	1.51
95.250 3.7500	190.500 7.5000	127.000 5.0000	104.775 4.1250	929000 209000	0.33	2.02	3.00	138000 31100	79300 17800	241000 54200	1.74

<sup>(1)</sup>Based on 1 x 10<sup>6</sup> revolutions L<sub>10</sub> life, for the ISO life-calculation method. C<sub>1(2)</sub> is the double-row radial value.

<sup>(2)</sup>Consult your Timken engineer for instructions on use or review the Timken Engineering Manual on [timken.com/catalogs](http://timken.com/catalogs).

<sup>(3)</sup>Based on 90 x 10<sup>6</sup> revolutions L<sub>10</sub> life, for The Timken Company life-calculation method. C<sub>90</sub> and C<sub>a90</sub> are radial and thrust values for a single row. C<sub>90(2)</sub> is the double-row radial value.

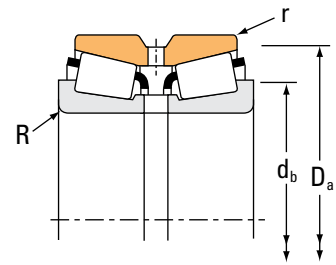
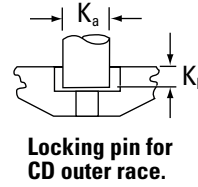
Part Number		Dimensions						Geometry Factors			Bearing Weight
Inner	Outer	Shaft		Housing		Pin		G <sub>1</sub>	G <sub>2</sub>	C <sub>G</sub>	
		Max. Shaft Fillet Radius R <sup>(4)</sup>	Backing Shoulder Dia. d <sub>b</sub>	Max. Housing Fillet Radius r <sup>(4)</sup>	Backing Shoulder Dia. D <sub>a</sub>	K <sub>a</sub>	K <sub>b</sub>				
		mm in.	mm in.	mm in.	mm in.	mm in.	mm in.				kg lbs.
42362	42587D	3.5 0.14	107.0 4.21	0.8 0.03	143.0 5.63	– –	– –	129.7	37.2	0.1386	4.08 8.97
598	592D	3.5 0.14	107.0 4.21	0.8 0.03	144.0 5.67	– –	– –	151.4	38.3	0.1416	5.50 12.11
598X	592D	3.5 0.14	107.0 4.21	0.8 0.03	144.0 5.67	– –	– –	151.4	38.3	0.1416	5.52 12.15
681	672D	3.5 0.14	110.0 4.33	0.8 0.03	160.0 6.30	– –	– –	182.5	37.3	0.1056	8.52 18.80
778	774D	3.5 0.14	111.0 4.37	1.5 0.06	168.0 6.61	– –	– –	227.3	41.3	0.1067	11.73 25.84
42368	42587D	3.0 0.12	107.0 4.21	0.8 0.03	143.0 5.63	– –	– –	129.7	37.2	0.1386	4.03 8.86
597	592D	3.5 0.14	109.0 4.29	0.8 0.03	144.0 5.67	– –	– –	151.4	38.3	0.1416	5.37 11.86
L319249	L319210D	1.5 0.06	103.0 4.06	0.8 0.03	125.0 4.92	– –	– –	125.3	90.8	0.1220	1.73 3.83
LM119348	LM119311D	2.3 0.09	105.0 4.13	0.8 0.03	131.0 5.16	– –	– –	149.4	84.1	0.1213	2.95 6.52
42375	42587D	3.0 0.12	108.0 4.25	0.8 0.03	143.0 5.63	– –	– –	129.7	37.2	0.1386	3.90 8.59
42376	42587D	3.5 0.14	109.0 4.29	0.8 0.03	143.0 5.63	– –	– –	129.7	37.2	0.1386	3.90 8.57
594	592D	3.5 0.14	110.0 4.33	0.8 0.03	144.0 5.67	– –	– –	151.4	38.3	0.1416	5.22 11.49
594A	592D	5.0 0.20	113.0 4.45	0.8 0.03	144.0 5.67	– –	– –	151.4	38.3	0.1416	5.20 11.46
52375	52637D	3.5 0.14	112.0 4.41	0.8 0.03	154.0 6.06	– –	– –	175.4	41.7	0.1519	6.49 14.33
683	672D	3.5 0.14	113.0 4.45	0.8 0.03	160.0 6.30	– –	– –	182.5	37.3	0.1056	8.17 18.02
776	774D	3.5 0.14	114.0 4.49	1.5 0.06	168.0 6.61	– –	– –	227.3	41.3	0.1067	11.56 25.47
HH221440	HH221410D	8.0 0.31	125.0 4.92	1.5 0.06	179.0 7.05	– –	– –	265.6	28.4	0.1072	15.61 34.39

<sup>(4)</sup>These maximum fillet radii will be cleared by bearing corners.  
NOTE: For spacer configuration information, contact your Timken engineer.

# TAPERED ROLLER BEARINGS

## DOUBLE-ROW • TYPE TDO

### TYPE TDO



Bearing Dimensions				Load Ratings							
Bore d	O.D. D	Width T	Double Outer Ring Width C	Dynamic <sup>(1)</sup>		Factors <sup>(2)</sup>		Dynamic <sup>(3)</sup>			Factors <sup>(2)</sup>
				C <sub>1(2)</sub>	e	Y <sub>1</sub>	Y <sub>2</sub>	C <sub>90</sub>	C <sub>a90</sub>	C <sub>90(2)</sub>	K
mm in.	mm in.	mm in.	mm in.	N lbf				N lbf	N lbf	N lbf	
96.838 3.8125	149.225 5.8750	66.672 2.6249	52.388 2.0625	336000 75600	0.49	1.37	2.04	50100 11300	42200 9480	87100 19600	1.19
98.425 3.8750	161.925 6.3750	82.547 3.2499	61.912 2.4375	389000 87500	0.47	1.42	2.12	57900 13000	47100 10600	101000 22700	1.23
98.425 3.8750	168.275 6.6250	92.075 3.6250	69.850 2.7500	461000 104000	0.47	1.43	2.14	68600 15400	55300 12400	119000 26900	1.24
98.425 3.8750	180.000 7.0866	104.775 4.1250	85.725 3.3750	603000 135000	0.39	1.75	2.61	89700 20200	59200 13300	156000 35100	1.51
98.425 3.8750	180.975 7.1250	104.775 4.1250	85.725 3.3750	603000 135000	0.39	1.75	2.61	89700 20200	59200 13300	156000 35100	1.51
98.425 3.8750	190.500 7.5000	127.000 5.0000	101.600 4.0000	797000 179000	0.33	2.02	3.00	119000 26700	68000 15300	207000 46400	1.74
98.425 3.8750	190.500 7.5000	127.000 5.0000	104.775 4.1250	929000 209000	0.33	2.02	3.00	138000 31100	79300 17800	241000 54200	1.74
98.425 3.8750	212.725 8.3750	142.875 5.6250	117.475 4.6250	996000 224000	0.33	2.07	3.09	148000 33300	82700 18600	258000 58000	1.79
98.425 3.8750	212.725 8.3750	142.875 5.6250	117.475 4.6250	1180000 266000	0.33	2.07	3.09	176000 39600	98300 22100	307000 69000	1.79
99.975 3.9360	212.725 8.3750	142.875 5.6250	117.475 4.6250	1180000 266000	0.33	2.07	3.09	176000 39600	98300 22100	307000 69000	1.79
99.979 3.9362	196.850 7.7500	103.378 4.0700	74.422 2.9300	656000 148000	0.61	1.11	1.66	97700 22000	101000 22800	170000 38300	0.96
99.982 3.9363	190.500 7.5000	127.000 5.0000	104.775 4.1250	929000 209000	0.33	2.02	3.00	138000 31100	79300 17800	241000 54200	1.74
100.000 3.9370	180.000 7.0866	104.775 4.1250	85.725 3.3750	603000 135000	0.39	1.75	2.61	89700 20200	59200 13300	156000 35100	1.51
100.000 3.9370	180.975 7.1250	104.775 4.1250	85.725 3.3750	603000 135000	0.39	1.75	2.61	89700 20200	59200 13300	156000 35100	1.51
100.000 3.9370	200.025 7.8750	115.888 4.5625	80.216 3.1581	839000 189000	0.63	1.07	1.59	125000 28100	135000 30400	217000 48900	0.92
100.012 3.9375	161.925 6.3750	82.547 3.2499	61.912 2.4375	389000 87500	0.47	1.42	2.12	57900 13000	47100 10600	101000 22700	1.23
101.600 4.0000	146.050 5.7500	49.212 1.9375	39.688 1.5625	167000 37600	0.39	1.72	2.56	24900 5600	16700 3760	43300 9740	1.49

<sup>(1)</sup>Based on  $1 \times 10^6$  revolutions  $L_{10}$  life, for the ISO life-calculation method.  $C_{1(2)}$  is the double-row radial value.

<sup>(2)</sup>Consult your Timken engineer for instructions on use or review the Timken Engineering Manual on [timken.com/catalogs](http://timken.com/catalogs).

<sup>(3)</sup>Based on  $90 \times 10^6$  revolutions  $L_{10}$  life, for The Timken Company life-calculation method.  $C_{90}$  and  $C_{a90}$  are radial and thrust values for a single row.  $C_{90(2)}$  is the double-row radial value.



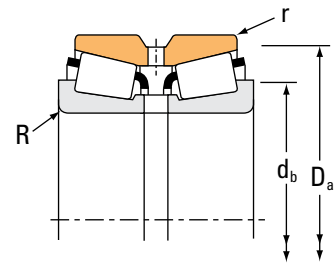
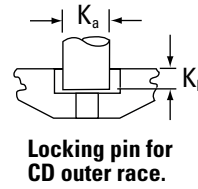
Part Number		Dimensions						Geometry Factors			Bearing Weight
Inner	Outer	Shaft		Housing		Pin		G <sub>1</sub>	G <sub>2</sub>	C <sub>G</sub>	
		Max. Shaft Fillet Radius R <sup>(4)</sup>	Backing Shoulder Dia. d <sub>b</sub>	Max. Housing Fillet Radius r <sup>(4)</sup>	Backing Shoulder Dia. D <sub>a</sub>	K <sub>a</sub>	K <sub>b</sub>				
		mm in.	mm in.	mm in.	mm in.	mm in.	mm in.				kg lbs.
42381	42587D	3.5 0.14	112.0 4.41	0.8 0.03	143.0 5.63	– –	– –	129.7	37.2	0.1386	3.78 8.33
52387	52637D	3.5 0.14	114.0 4.49	0.8 0.03	154.0 6.06	– –	– –	175.4	41.7	0.1519	6.16 13.58
685	672D	3.5 0.14	116.0 4.57	0.8 0.03	160.0 6.30	– –	– –	182.5	37.3	0.1056	7.85 17.29
779	773D	3.5 0.14	116.0 4.57	0.8 0.03	168.0 6.61	– –	– –	227.3	41.3	0.1067	10.97 24.18
779	774D	3.5 0.14	116.0 4.57	1.5 0.06	168.0 6.61	– –	– –	227.3	41.3	0.1067	10.98 24.20
866	854D	3.5 0.14	118.0 4.65	1.5 0.06	174.0 6.85	– –	– –	264.1	44.9	0.1072	15.41 33.97
HH221442	HH221410D	3.5 0.14	119.0 4.69	1.5 0.06	179.0 7.05	– –	– –	265.6	28.4	0.1072	15.24 33.61
943	932CD	3.5 0.14	120.0 4.72	1.5 0.06	193.1 7.60	22.23 0.88	8.73 0.34	338.6	39.8	0.1153	23.16 51.08
HH224332	HH224310CD	3.5 0.14	123.0 4.84	1.5 0.06	201.7 7.94	25.40 1.00	7.95 0.31	366.6	47.9	0.1182	23.40 51.56
HH224334	HH224310CD	3.5 0.14	124.0 4.88	1.5 0.06	201.7 7.94	25.40 1.00	7.95 0.31	366.6	47.9	0.1182	23.21 51.17
HM821547	HM821511D	3.5 0.14	123.0 4.84	1.5 0.06	187.0 7.36	– –	– –	166.2	24.2	0.1100	12.42 27.39
HH221447	HH221410D	6.4 0.25	126.0 4.96	1.5 0.06	179.0 7.05	– –	– –	265.6	28.4	0.1072	14.89 32.80
783	773D	3.5 0.14	118.0 4.65	0.8 0.03	168.0 6.61	– –	– –	227.3	41.3	0.1067	10.83 23.87
783	774D	3.5 0.14	118.0 4.65	1.5 0.06	168.0 6.61	– –	– –	227.3	41.3	0.1067	10.78 23.74
98394X	98789D	3.5 0.14	126.0 4.96	2.3 0.09	188.0 7.40	– –	– –	203.4	37.5	0.1197	14.94 32.93
52393	52637D	3.5 0.14	116.0 4.57	0.8 0.03	154.0 6.06	– –	– –	175.4	41.7	0.1519	6.38 14.09
L521945	L521910D	1.5 0.06	112.0 4.41	0.8 0.03	141.0 5.55	– –	– –	152.1	107.9	0.1346	2.51 5.55

<sup>(4)</sup>These maximum fillet radii will be cleared by bearing corners.  
NOTE: For spacer configuration information, contact your Timken engineer.

# TAPERED ROLLER BEARINGS

## DOUBLE-ROW • TYPE TDO

### TYPE TDO



Bearing Dimensions				Load Ratings							
Bore d	O.D. D	Width T	Double Outer Ring Width C	Dynamic <sup>(1)</sup>		Factors <sup>(2)</sup>		Dynamic <sup>(3)</sup>			Factors <sup>(2)</sup>
				C <sub>1(2)</sub>	e	Y <sub>1</sub>	Y <sub>2</sub>	C <sub>90</sub>	C <sub>a90</sub>	C <sub>90(2)</sub>	K
mm in.	mm in.	mm in.	mm in.	N lbf				N lbf	N lbf	N lbf	
101.600 4.0000	146.050 5.7500	49.212 1.9375	38.895 1.5313	223000 50100	0.39	1.74	2.59	33200 7460	22000 4950	57800 13000	1.51
101.600 4.0000	161.925 6.3750	82.547 3.2499	61.912 2.4375	389000 87500	0.47	1.42	2.12	57900 13000	47100 10600	101000 22700	1.23
101.600 4.0000	161.925 6.3750	82.547 3.2499	61.912 2.4375	389000 87500	0.47	1.42	2.12	57900 13000	47100 10600	101000 22700	1.23
101.600 4.0000	165.100 6.5000	106.350 4.1870	114.300 4.5000	470000 106000	0.26	2.55	3.80	70000 15700	31700 7130	122000 27400	2.21
101.600 4.0000	168.275 6.6250	92.075 3.6250	69.850 2.7500	461000 104000	0.47	1.43	2.14	68600 15400	55300 12400	119000 26900	1.24
101.600 4.0000	180.000 7.0866	104.775 4.1250	85.725 3.3750	603000 135000	0.39	1.75	2.61	89700 20200	59200 13300	156000 35100	1.51
101.600 4.0000	180.975 7.1250	104.775 4.1250	85.725 3.3750	603000 135000	0.39	1.75	2.61	89700 20200	59200 13300	156000 35100	1.51
101.600 4.0000	180.975 7.1250	104.775 4.1250	85.725 3.3750	603000 135000	0.39	1.75	2.61	89700 20200	59200 13300	156000 35100	1.51
101.600 4.0000	190.500 7.5000	127.000 5.0000	101.600 4.0000	797000 179000	0.33	2.02	3.00	119000 26700	68000 15300	207000 46400	1.74
101.600 4.0000	190.500 7.5000	127.000 5.0000	104.775 4.1250	929000 209000	0.33	2.02	3.00	138000 31100	79300 17800	241000 54200	1.74
101.600 4.0000	200.025 7.8750	115.888 4.5625	80.216 3.1581	839000 189000	0.63	1.07	1.59	125000 28100	135000 30400	217000 48900	0.92
101.600 4.0000	212.725 8.3750	142.875 5.6250	117.475 4.6250	996000 224000	0.33	2.07	3.09	148000 33300	82700 18600	258000 58000	1.79
101.600 4.0000	212.725 8.3750	142.875 5.6250	117.475 4.6250	1180000 266000	0.33	2.07	3.09	176000 39600	98300 22100	307000 69000	1.79
101.600 4.0000	214.312 8.4375	115.888 4.5625	84.138 3.3125	970000 218000	0.67	1.00	1.49	144000 32500	167000 37500	251000 56500	0.87
104.775 4.1250	180.000 7.0866	104.775 4.1250	85.725 3.3750	603000 135000	0.39	1.75	2.61	89700 20200	59200 13300	156000 35100	1.51
104.775 4.1250	180.000 7.0866	104.775 4.1250	85.725 3.3750	603000 135000	0.39	1.75	2.61	89700 20200	59200 13300	156000 35100	1.51
104.775 4.1250	180.000 7.0866	104.775 4.1250	85.725 3.3750	603000 135000	0.39	1.75	2.61	89700 20200	59200 13300	156000 35100	1.51

<sup>(1)</sup>Based on 1 x 10<sup>6</sup> revolutions L<sub>10</sub> life, for the ISO life-calculation method. C<sub>1(2)</sub> is the double-row radial value.

<sup>(2)</sup>Consult your Timken engineer for instructions on use or review the Timken Engineering Manual on [timken.com/catalogs](http://timken.com/catalogs).

<sup>(3)</sup>Based on 90 x 10<sup>6</sup> revolutions L<sub>10</sub> life, for The Timken Company life-calculation method. C<sub>90</sub> and C<sub>a90</sub> are radial and thrust values for a single row. C<sub>90(2)</sub> is the double-row radial value.

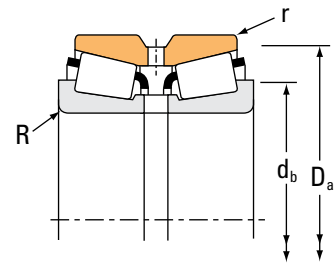
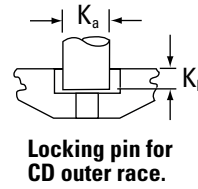
Part Number		Dimensions						Geometry Factors			Bearing Weight
Inner	Outer	Shaft		Housing		Pin		G <sub>1</sub>	G <sub>2</sub>	C <sub>G</sub>	
		Max. Shaft Fillet Radius R <sup>(4)</sup>	Backing Shoulder Dia. d <sub>b</sub>	Max. Housing Fillet Radius r <sup>(4)</sup>	Backing Shoulder Dia. D <sub>a</sub>	K <sub>a</sub>	K <sub>b</sub>				
		mm in.	mm in.	mm in.	mm in.	mm in.	mm in.				kg lbs.
LM520349	LM520310D	1.5 0.06	110.0 4.33	0.8 0.03	140.0 5.51	– –	– –	120.9	58.5	0.1249	2.44 5.37
52400	52637D	3.5 0.14	117.0 4.61	0.8 0.03	154.0 6.06	– –	– –	175.4	41.7	0.1519	5.85 12.89
52401	52637D	8.0 0.31	128.0 5.04	0.8 0.03	154.0 6.06	– –	– –	175.4	41.7	0.1519	5.82 12.83
HM120848	HM120817XD	1.5 0.06	112.0 4.41	1.0 0.04	154.7 6.09	– –	– –	226.8	59.7	0.0941	8.87 19.53
687	672D	3.5 0.14	118.0 4.65	0.8 0.03	160.0 6.30	– –	– –	182.5	37.3	0.1056	7.47 16.49
780	773D	3.5 0.14	119.0 4.69	0.8 0.03	168.0 6.61	– –	– –	227.3	41.3	0.1067	10.58 23.33
780	774D	3.5 0.14	119.0 4.69	1.5 0.06	168.0 6.61	– –	– –	227.3	41.3	0.1067	10.63 23.42
780	774CD	3.5 0.14	119.0 4.69	1.5 0.06	168.0 6.61	19.05 0.75	7.13 0.28	227.3	41.3	0.1067	10.63 23.42
861	854D	8.0 0.31	129.0 5.08	1.5 0.06	174.0 6.85	– –	– –	264.1	44.9	0.1072	14.85 32.71
HH221449	HH221410D	8.0 0.31	131.0 5.16	1.5 0.06	179.0 7.05	– –	– –	265.6	28.4	0.1072	14.69 32.40
98400	98789D	3.5 0.14	128.0 5.04	2.3 0.09	188.0 7.40	– –	– –	203.4	37.5	0.1197	14.59 32.17
941	932CD	7.0 0.28	130.0 5.12	1.5 0.06	193.1 7.60	22.23 0.88	8.73 0.34	338.6	39.8	0.1153	22.56 49.74
HH224335	HH224310CD	7.0 0.28	132.0 5.20	1.5 0.06	201.7 7.94	25.40 1.00	7.95 0.31	366.6	47.9	0.1182	22.87 50.44
H924033	H924010D	3.5 0.14	132.0 5.20	1.5 0.06	205.0 8.07	– –	– –	245.6	32.2	0.1299	18.56 40.91
782	773D	3.5 0.14	122.0 4.80	0.8 0.03	168.0 6.61	– –	– –	227.3	41.3	0.1067	10.25 22.60
786	773D	6.4 0.25	128.0 5.04	0.8 0.03	168.0 6.61	– –	– –	227.3	41.3	0.1067	10.14 22.35
787	773D	7.0 0.28	129.0 5.08	0.8 0.03	168.0 6.61	– –	– –	227.3	41.3	0.1067	10.13 22.37

<sup>(4)</sup>These maximum fillet radii will be cleared by bearing corners.  
NOTE: For spacer configuration information, contact your Timken engineer.

# TAPERED ROLLER BEARINGS

## DOUBLE-ROW • TYPE TDO

### TYPE TDO



Bearing Dimensions				Load Ratings							
Bore d	O.D. D	Width T	Double Outer Ring Width C	Dynamic <sup>(1)</sup>				Dynamic <sup>(3)</sup>			
				C <sub>1(2)</sub>	e	Y <sub>1</sub>	Y <sub>2</sub>	C <sub>90</sub>	C <sub>a90</sub>	C <sub>90(2)</sub>	K
mm in.	mm in.	mm in.	mm in.	N lbf				N lbf	N lbf	N lbf	
104.775 4.1250	180.975 7.1250	104.775 4.1250	85.725 3.3750	603000 135000	0.39	1.75	2.61	89700 20200	59200 13300	156000 35100	1.51
104.775 4.1250	190.500 7.5000	106.362 4.1875	80.962 3.1875	633000 142000	0.42	1.62	2.42	94300 21200	67100 15100	164000 36900	1.40
106.362 4.1875	165.100 6.5000	82.550 3.2500	63.500 2.5000	394000 88600	0.50	1.36	2.02	58700 13200	50000 11200	102000 23000	1.18
106.362 4.1875	165.100 6.5000	82.550 3.2500	63.500 2.5000	394000 88600	0.50	1.36	2.02	58700 13200	50000 11200	102000 23000	1.18
107.950 4.2500	146.050 5.7500	49.212 1.9375	39.688 1.5625	155000 34800	0.39	1.72	2.56	23100 5180	15500 3480	40100 9020	1.49
107.950 4.2500	158.750 6.2500	53.978 2.1251	39.688 1.5625	238000 53400	0.61	1.11	1.66	35400 7960	36700 8250	61600 13900	0.96
107.950 4.2500	159.987 6.2987	74.612 2.9375	58.738 2.3125	404000 90800	0.40	1.68	2.50	60100 13500	41400 9300	105000 23500	1.45
107.950 4.2500	165.100 6.5000	82.550 3.2500	63.500 2.5000	394000 88600	0.50	1.36	2.02	58700 13200	50000 11200	102000 23000	1.18
107.950 4.2500	165.100 6.5000	82.550 3.2500	63.500 2.5000	394000 88600	0.50	1.36	2.02	58700 13200	50000 11200	102000 23000	1.18
107.950 4.2500	190.500 7.5000	106.362 4.1875	80.962 3.1875	633000 142000	0.42	1.62	2.42	94300 21200	67100 15100	164000 36900	1.40
107.950 4.2500	212.725 8.3750	142.875 5.6250	117.475 4.6250	996000 224000	0.33	2.07	3.09	148000 33300	82700 18600	258000 58000	1.79
107.950 4.2500	212.725 8.3750	142.875 5.6250	117.475 4.6250	1180000 266000	0.33	2.07	3.09	176000 39600	98300 22100	307000 69000	1.79
109.538 4.3125	158.750 6.2500	53.978 2.1251	39.688 1.5625	201000 45100	0.61	1.11	1.66	29900 6710	31000 6960	52000 11700	0.96
109.952 4.3288	190.500 7.5000	106.362 4.1875	80.962 3.1875	633000 142000	0.42	1.62	2.42	94300 21200	67100 15100	164000 36900	1.40
109.987 4.3302	159.987 6.2987	74.612 2.9375	58.738 2.3125	341000 76600	0.40	1.68	2.50	50700 11400	34900 7850	88400 19900	1.45
109.987 4.3302	159.987 6.2987	74.612 2.9375	58.738 2.3125	404000 90800	0.40	1.68	2.50	60100 13500	41400 9300	105000 23500	1.45
109.992 4.3304	177.800 7.0000	92.075 3.6250	69.850 2.7500	478000 108000	0.52	1.31	1.95	71200 16000	62900 14100	124000 27900	1.13

<sup>(1)</sup>Based on 1 x 10<sup>6</sup> revolutions L<sub>10</sub> life, for the ISO life-calculation method. C<sub>1(2)</sub> is the double-row radial value.

<sup>(2)</sup>Consult your Timken engineer for instructions on use or review the Timken Engineering Manual on [timken.com/catalogs](http://timken.com/catalogs).

<sup>(3)</sup>Based on 90 x 10<sup>6</sup> revolutions L<sub>10</sub> life, for The Timken Company life-calculation method. C<sub>90</sub> and C<sub>a90</sub> are radial and thrust values for a single row. C<sub>90(2)</sub> is the double-row radial value.

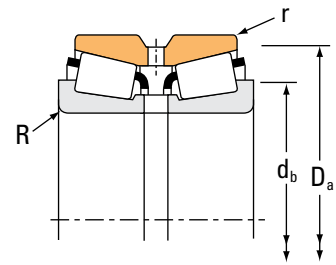
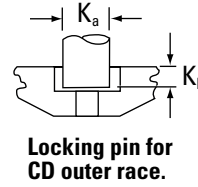
Part Number		Dimensions						Geometry Factors			Bearing Weight
Inner	Outer	Shaft		Housing		Pin		G <sub>1</sub>	G <sub>2</sub>	C <sub>G</sub>	
		Max. Shaft Fillet Radius R <sup>(4)</sup>	Backing Shoulder Dia. d <sub>b</sub>	Max. Housing Fillet Radius r <sup>(4)</sup>	Backing Shoulder Dia. D <sub>a</sub>	K <sub>a</sub>	K <sub>b</sub>				
		mm in.	mm in.	mm in.	mm in.	mm in.	mm in.				kg lbs.
782	774D	3.5 0.14	122.0 4.80	1.5 0.06	168.0 6.61	– –	– –	227.3	41.3	0.1067	10.20 22.47
71412	71751D	3.5 0.14	124.0 4.88	1.5 0.06	181.0 7.13	– –	– –	269.2	49.5	0.1156	12.34 27.21
56418	56650CD	3.5 0.14	122.0 4.80	0.8 0.03	159.0 6.26	14.29 0.56	5.56 0.22	190.9	47.7	0.1584	5.97 13.15
56418	56650D	3.5 0.14	122.0 4.80	0.8 0.03	159.0 6.26	– –	– –	190.9	47.7	0.1584	5.95 13.12
L521949	L521910D	1.5 0.06	116.0 4.57	0.8 0.03	141.0 5.55	– –	– –	152.1	107.9	0.1346	2.18 4.80
37425	37626D	3.5 0.14	122.0 4.80	0.8 0.03	152.0 5.98	– –	– –	123.7	57.1	0.1443	3.21 7.07
LM522546	LM522510D	3.5 0.14	122.0 4.80	0.8 0.03	154.0 6.06	– –	– –	231.6	63.4	0.1576	5.05 11.11
56425	56650D	3.5 0.14	123.0 4.84	0.8 0.03	159.0 6.26	– –	– –	190.9	47.7	0.1584	6.37 14.05
56425	56650CD	3.5 0.14	123.0 4.84	0.8 0.03	159.0 6.26	14.29 0.56	5.56 0.22	190.9	47.7	0.1584	6.37 14.05
71425	71751D	3.6 0.14	126.0 4.96	1.5 0.06	181.0 7.13	– –	– –	269.2	49.5	0.1156	11.89 26.24
936	932CD	8.0 0.31	137.0 5.39	1.5 0.06	193.1 7.60	22.23 0.88	8.73 0.34	338.6	39.8	0.1153	21.52 47.42
HH224340	HH224310CD	8.0 0.31	139.0 5.47	1.5 0.06	201.7 7.94	25.40 1.00	7.95 0.31	366.6	47.9	0.1182	21.63 47.68
37431	37626D	3.5 0.14	123.0 4.84	0.8 0.03	152.0 5.98	– –	– –	123.7	57.1	0.1443	3.15 6.94
71432	71751D	3.5 0.14	128.0 5.04	1.5 0.06	181.0 7.13	– –	– –	269.2	49.5	0.1156	12.02 26.52
LM522548	LM522510D	8.0 0.31	133.0 5.24	0.8 0.03	154.0 6.06	– –	– –	231.6	63.4	0.1576	4.71 10.37
LM522549	LM522510D	3.5 0.14	124.0 4.88	0.8 0.03	154.0 6.06	– –	– –	231.6	63.4	0.1576	4.85 10.69
64433	64700D	3.5 0.14	128.0 5.04	0.8 0.03	172.0 6.77	– –	– –	218.8	45.3	0.1153	8.31 18.31

<sup>(4)</sup>These maximum fillet radii will be cleared by bearing corners.  
NOTE: For spacer configuration information, contact your Timken engineer.

# TAPERED ROLLER BEARINGS

## DOUBLE-ROW • TYPE TDO

### TYPE TDO



Bearing Dimensions				Load Ratings							
Bore d	O.D. D	Width T	Double Outer Ring Width C	Dynamic <sup>(1)</sup>				Dynamic <sup>(3)</sup>			
				C <sub>1(2)</sub>	e	Y <sub>1</sub>	Y <sub>2</sub>	C <sub>90</sub>	C <sub>a90</sub>	C <sub>90(2)</sub>	K
mm in.	mm in.	mm in.	mm in.	N lbf				N lbf	N lbf	N lbf	
111.125 4.3750	190.500 7.5000	106.362 4.1875	80.962 3.1875	633000 142000	0.42	1.62	2.42	94300 21200	67100 15100	164000 36900	1.40
114.300 4.5000	177.800 7.0000	92.075 3.6250	69.850 2.7500	478000 108000	0.52	1.31	1.95	71200 16000	62900 14100	124000 27900	1.13
114.300 4.5000	190.500 7.5000	106.362 4.1875	80.962 3.1875	633000 142000	0.42	1.62	2.42	94300 21200	67100 15100	164000 36900	1.40
114.300 4.5000	212.725 8.3750	142.875 5.6250	117.475 4.6250	996000 224000	0.33	2.07	3.09	148000 33300	82700 18600	258000 58000	1.79
114.300 4.5000	212.725 8.3750	142.875 5.6250	117.475 4.6250	1180000 266000	0.33	2.07	3.09	176000 39600	98300 22100	307000 69000	1.79
114.975 4.5266	212.725 8.3750	142.875 5.6250	117.475 4.6250	1180000 266000	0.33	2.07	3.09	176000 39600	98300 22100	307000 69000	1.79
115.087 4.5310	190.500 7.5000	106.362 4.1875	80.962 3.1875	633000 142000	0.42	1.62	2.42	94300 21200	67100 15100	164000 36900	1.40
119.964 4.7230	215.900 8.5000	106.362 4.1875	80.962 3.1875	665000 150000	0.49	1.38	2.06	99000 22300	82600 18600	172000 38800	1.20
120.650 4.7500	161.925 6.3750	63.500 2.5000	53.975 2.1250	183000 41200	0.43	1.55	2.31	27300 6140	20300 4570	47500 10700	1.34
120.650 4.7500	174.625 6.8750	77.788 3.0625	61.912 2.4375	426000 95700	0.33	2.03	3.02	63400 14200	36100 8110	110000 24800	1.76
120.650 4.7500	182.562 7.1875	85.725 3.3750	73.025 2.8750	466000 105000	0.31	2.21	3.29	69400 15600	36300 8160	121000 27200	1.91
120.650 4.7500	206.375 8.1250	107.950 4.2500	82.550 3.2500	658000 148000	0.46	1.47	2.19	98000 22000	77000 17300	171000 38400	1.27
120.650 4.7500	234.950 9.2500	142.875 5.6250	114.300 4.5000	1090000 246000	0.37	1.83	2.72	163000 36700	103000 23200	284000 63800	1.58
123.825 4.8750	182.562 7.1875	85.725 3.3750	73.025 2.8750	466000 105000	0.31	2.21	3.29	69400 15600	36300 8160	121000 27200	1.91
124.943 4.9190	234.950 9.2500	142.875 5.6250	114.300 4.5000	1090000 246000	0.37	1.83	2.72	163000 36700	103000 23200	284000 63800	1.58
127.000 5.0000	169.975 6.6919	58.738 2.3125	49.212 1.9375	249000 55900	0.33	2.03	3.02	37000 8320	21100 4740	64500 14500	1.76
127.000 5.0000	182.562 7.1875	85.725 3.3750	73.025 2.8750	466000 105000	0.31	2.21	3.29	69400 15600	36300 8160	121000 27200	1.91

<sup>(1)</sup>Based on 1 x 10<sup>6</sup> revolutions L<sub>10</sub> life, for the ISO life-calculation method. C<sub>1(2)</sub> is the double-row radial value.

<sup>(2)</sup>Consult your Timken engineer for instructions on use or review the Timken Engineering Manual on [timken.com/catalogs](http://timken.com/catalogs).

<sup>(3)</sup>Based on 90 x 10<sup>6</sup> revolutions L<sub>10</sub> life, for The Timken Company life-calculation method. C<sub>90</sub> and C<sub>a90</sub> are radial and thrust values for a single row. C<sub>90(2)</sub> is the double-row radial value.

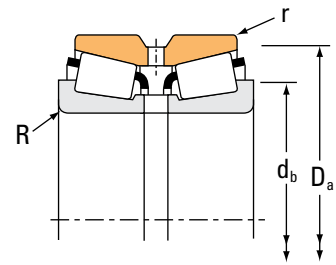
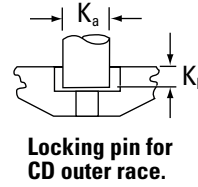
Part Number		Dimensions						Geometry Factors			Bearing Weight
Inner	Outer	Shaft		Housing		Pin		G <sub>1</sub>	G <sub>2</sub>	C <sub>G</sub>	
		Max. Shaft Fillet Radius R <sup>(4)</sup>	Backing Shoulder Dia. d <sub>b</sub>	Max. Housing Fillet Radius r <sup>(4)</sup>	Backing Shoulder Dia. D <sub>a</sub>	K <sub>a</sub>	K <sub>b</sub>				
		mm in.	mm in.	mm in.	mm in.	mm in.	mm in.				kg lbs.
71437	71751D	3.6 0.14	129.0 5.08	1.5 0.06	181.0 7.13	– –	– –	269.2	49.5	0.1156	11.52 25.41
64450	64700D	3.5 0.14	131.0 5.16	0.8 0.03	172.0 6.77	– –	– –	218.8	45.3	0.1153	7.81 17.21
71450	71751D	3.6 0.14	132.0 5.20	1.5 0.06	181.0 7.13	– –	– –	269.2	49.5	0.1156	11.12 24.50
938	932CD	7.0 0.28	141.0 5.55	1.5 0.06	193.1 7.60	22.23 0.88	8.73 0.34	338.6	39.8	0.1153	20.31 44.78
HH224346	HH224310CD	7.0 0.28	143.0 5.63	1.5 0.06	201.7 7.94	25.40 1.00	7.95 0.31	366.6	47.9	0.1182	20.46 45.09
HH224349	HH224310CD	7.0 0.28	144.0 5.67	1.5 0.06	201.7 7.94	25.40 1.00	7.95 0.31	366.6	47.9	0.1182	20.33 44.84
71453	71751D	3.5 0.14	133.0 5.24	1.5 0.06	181.0 7.13	– –	– –	269.2	49.5	0.1156	10.91 24.06
74472	74851CD	3.5 0.14	142.0 5.59	1.5 0.06	208.0 8.19	19.05 0.75	7.13 0.28	362.9	68.5	0.1338	15.86 34.95
L624549	L624514D	1.5 0.06	129.0 5.08	0.8 0.03	156.0 6.14	– –	– –	195.2	139.1	0.1509	3.24 7.11
M224749	M224710D	3.5 0.14	135.0 5.31	0.8 0.03	167.9 6.61	– –	– –	279.1	86.6	0.1575	5.65 12.49
48282	48220D	3.5 0.14	137.0 5.39	0.8 0.03	176.0 6.93	– –	– –	353.0	91.4	0.1138	7.83 17.29
795	792CD	3.3 0.13	139.0 5.47	0.8 0.03	198.0 7.80	19.05 0.75	7.95 0.31	326.4	62.0	0.1269	13.69 30.20
95475	95927CD	6.4 0.25	149.0 5.87	1.5 0.06	217.0 8.54	22.23 0.88	8.73 0.34	453.9	59.4	0.1323	26.75 59.00
48286	48220D	3.5 0.14	139.0 5.47	0.8 0.03	176.0 6.93	– –	– –	353.0	91.4	0.1138	7.54 16.65
95491	95927CD	6.4 0.25	152.0 5.98	1.5 0.06	217.0 8.54	22.23 0.88	8.73 0.34	453.9	59.4	0.1323	25.68 56.62
L225849	L225812D	1.5 0.06	136.0 5.35	1.0 0.04	164.0 6.46	– –	– –	253.2	134.6	0.1511	3.41 7.51
48290	48220D	3.5 0.14	141.0 5.55	0.8 0.03	176.0 6.93	– –	– –	353.0	91.4	0.1138	7.09 15.62

<sup>(4)</sup>These maximum fillet radii will be cleared by bearing corners.  
NOTE: For spacer configuration information, contact your Timken engineer.

# TAPERED ROLLER BEARINGS

## DOUBLE-ROW • TYPE TDO

### TYPE TDO



Bearing Dimensions				Load Ratings							
Bore d	O.D. D	Width T	Double Outer Ring Width C	Dynamic <sup>(1)</sup>				Dynamic <sup>(3)</sup>			
				C <sub>1(2)</sub>	e	Y <sub>1</sub>	Y <sub>2</sub>	C <sub>90</sub>	C <sub>a90</sub>	C <sub>90(2)</sub>	K
mm in.	mm in.	mm in.	mm in.	N lbf				N lbf	N lbf	N lbf	
127.000 5.0000	196.850 7.7500	101.600 4.0000	85.725 3.3750	640000 144000	0.34	1.96	2.92	95300 21400	56100 12600	166000 37300	1.70
127.000 5.0000	200.025 7.8750	101.600 4.0000	85.725 3.3750	640000 144000	0.34	1.96	2.92	95300 21400	56100 12600	166000 37300	1.70
127.000 5.0000	206.375 8.1250	107.950 4.2500	82.550 3.2500	587000 132000	0.46	1.47	2.19	87300 19600	68600 15400	152000 34200	1.27
127.000 5.0000	215.900 8.5000	106.362 4.1875	80.962 3.1875	665000 150000	0.49	1.38	2.06	99000 22300	82600 18600	172000 38800	1.20
127.000 5.0000	228.600 9.0000	115.888 4.5625	84.138 3.3125	1020000 230000	0.74	0.92	1.36	152000 34200	192000 43100	265000 59500	0.79
127.000 5.0000	234.950 9.2500	142.875 5.6250	114.300 4.5000	1090000 246000	0.37	1.83	2.72	163000 36700	103000 23200	284000 63800	1.58
128.588 5.0625	206.375 8.1250	107.950 4.2500	82.550 3.2500	658000 148000	0.46	1.47	2.19	98000 22000	77000 17300	171000 38400	1.27
130.000 5.1181	206.375 8.1250	107.950 4.2500	82.550 3.2500	658000 148000	0.46	1.47	2.19	98000 22000	77000 17300	171000 38400	1.27
130.175 5.1250	196.850 7.7500	101.600 4.0000	85.725 3.3750	640000 144000	0.34	1.96	2.92	95300 21400	56100 12600	166000 37300	1.70
130.175 5.1250	200.025 7.8750	101.600 4.0000	85.725 3.3750	640000 144000	0.34	1.96	2.92	95300 21400	56100 12600	166000 37300	1.70
130.175 5.1250	206.375 8.1250	107.950 4.2500	82.550 3.2500	658000 148000	0.46	1.47	2.19	98000 22000	77000 17300	171000 38400	1.27
133.350 5.2500	177.008 6.9688	57.150 2.2500	47.625 1.8750	256000 57600	0.35	1.94	2.89	38100 8570	22700 5110	66400 14900	1.68
133.350 5.2500	190.500 7.5000	85.725 3.3750	73.025 2.8750	492000 111000	0.32	2.10	3.13	73300 16500	40300 9060	128000 28700	1.82
133.350 5.2500	196.850 7.7500	101.600 4.0000	85.725 3.3750	640000 144000	0.34	1.96	2.92	95300 21400	56100 12600	166000 37300	1.70
133.350 5.2500	196.850 7.7500	101.600 4.0000	85.725 3.3750	640000 144000	0.34	1.96	2.92	95300 21400	56100 12600	166000 37300	1.70
133.350 5.2500	200.025 7.8750	101.600 4.0000	85.725 3.3750	640000 144000	0.34	1.96	2.92	95300 21400	56100 12600	166000 37300	1.70
133.350 5.2500	215.900 8.5000	106.362 4.1875	80.962 3.1875	665000 150000	0.49	1.38	2.06	99000 22300	82600 18600	172000 38800	1.20

<sup>(1)</sup>Based on 1 x 10<sup>6</sup> revolutions L<sub>10</sub> life, for the ISO life-calculation method. C<sub>1(2)</sub> is the double-row radial value.

<sup>(2)</sup>Consult your Timken engineer for instructions on use or review the Timken Engineering Manual on [timken.com/catalogs](http://timken.com/catalogs).

<sup>(3)</sup>Based on 90 x 10<sup>6</sup> revolutions L<sub>10</sub> life, for The Timken Company life-calculation method. C<sub>90</sub> and C<sub>a90</sub> are radial and thrust values for a single row. C<sub>90(2)</sub> is the double-row radial value.



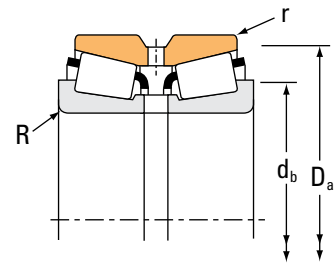
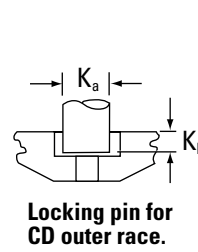
Part Number		Dimensions						Geometry Factors			Bearing Weight
Inner	Outer	Shaft		Housing		Pin		G <sub>1</sub>	G <sub>2</sub>	C <sub>G</sub>	
		Max. Shaft Fillet Radius R <sup>(4)</sup>	Backing Shoulder Dia. d <sub>b</sub>	Max. Housing Fillet Radius r <sup>(4)</sup>	Backing Shoulder Dia. D <sub>a</sub>	K <sub>a</sub>	K <sub>b</sub>				
		mm in.	mm in.	mm in.	mm in.	mm in.	mm in.				kg lbs.
67388	67322D	3.5 0.14	144.0 5.67	0.8 0.03	190.0 7.48	– –	– –	383.7	70.1	0.1220	10.71 23.62
67388	67325D	3.5 0.14	144.0 5.67	0.8 0.03	191.0 7.52	– –	– –	383.7	70.1	0.1220	11.36 25.06
798	792CD	3.3 0.13	146.0 5.75	0.8 0.03	198.0 7.80	19.05 0.75	7.95 0.31	307.9	58.6	0.1243	12.49 27.52
74500	74851CD	3.5 0.14	148.0 5.83	1.5 0.06	208.0 8.19	19.05 0.75	7.13 0.28	362.9	68.5	0.1338	14.81 32.66
HM926747	HM926710CD	3.5 0.14	156.0 6.14	2.3 0.09	219.5 8.64	19.05 0.75	8.73 0.34	295.4	39.0	0.1416	18.24 40.22
95500	95927CD	6.4 0.25	154.0 6.06	1.5 0.06	217.0 8.54	22.23 0.88	8.73 0.34	453.9	59.4	0.1323	25.35 55.89
799	792CD	3.3 0.13	146.0 5.75	0.8 0.03	198.0 7.80	19.05 0.75	7.95 0.31	326.4	62.0	0.1269	12.43 27.42
797	792CD	3.5 0.14	148.0 5.83	0.8 0.03	198.0 7.80	19.05 0.75	7.95 0.31	326.4	62.0	0.1269	12.12 26.75
67389	67322D	3.5 0.14	147.0 5.79	0.8 0.03	190.0 7.48	– –	– –	383.7	70.1	0.1220	10.15 22.39
67389	67325D	3.5 0.14	147.0 5.79	0.8 0.03	191.0 7.52	– –	– –	383.7	70.1	0.1220	10.80 23.82
799A	792CD	3.5 0.14	148.0 5.83	0.8 0.03	198.0 7.80	19.05 0.75	7.95 0.31	326.4	62.0	0.1269	12.16 26.81
L327249	L327210D	1.5 0.06	142.0 5.59	0.8 0.03	171.0 6.73	– –	– –	280.1	155.8	0.1585	3.67 8.09
48385	48320D	3.5 0.14	148.0 5.83	0.8 0.03	184.0 7.24	– –	– –	403.8	105.1	0.1209	7.42 16.35
67390	67322D	3.5 0.14	150.0 5.91	0.8 0.03	190.0 7.48	– –	– –	383.7	70.1	0.1220	9.64 21.28
67391	67322D	8.0 0.31	157.0 6.18	0.8 0.03	190.0 7.48	– –	– –	383.7	70.1	0.1220	9.58 21.12
67390	67325D	3.5 0.14	150.0 5.91	0.8 0.03	191.0 7.52	– –	– –	383.7	70.1	0.1220	10.29 22.71
74525	74851CD	3.5 0.14	152.0 5.98	1.5 0.06	208.0 8.19	19.05 0.75	7.13 0.28	362.9	68.5	0.1338	13.84 30.50

<sup>(4)</sup>These maximum fillet radii will be cleared by bearing corners.  
NOTE: For spacer configuration information, contact your Timken engineer.

# TAPERED ROLLER BEARINGS

## DOUBLE-ROW • TYPE TDO

### TYPE TDO



Bearing Dimensions				Load Ratings							
Bore d	O.D. D	Width T	Double Outer Ring Width C	Dynamic <sup>(1)</sup>		Factors <sup>(2)</sup>		Dynamic <sup>(3)</sup>			Factors <sup>(2)</sup>
				C <sub>1(2)</sub>	e	Y <sub>1</sub>	Y <sub>2</sub>	C <sub>90</sub>	C <sub>a90</sub>	C <sub>90(2)</sub>	K
mm in.	mm in.	mm in.	mm in.	N lbf				N lbf	N lbf	N lbf	
133.350 5.2500	234.950 9.2500	142.875 5.6250	114.300 4.5000	1090000 246000	0.37	1.83	2.72	163000 36700	103000 23200	284000 63800	1.58
133.350 5.2500	234.950 9.2500	142.875 5.6250	114.300 4.5000	1090000 246000	0.37	1.83	2.72	163000 36700	103000 23200	284000 63800	1.58
136.525 5.3750	190.500 7.5000	85.725 3.3750	73.025 2.8750	492000 111000	0.32	2.10	3.13	73300 16500	40300 9060	128000 28700	1.82
136.525 5.3750	215.900 8.5000	106.362 4.1875	80.962 3.1875	665000 150000	0.49	1.38	2.06	99000 22300	82600 18600	172000 38800	1.20
136.525 5.3750	228.600 9.0000	123.825 4.8750	98.425 3.8750	906000 204000	0.42	1.60	2.39	135000 30300	97200 21800	235000 52800	1.39
136.525 5.3750	254.000 10.0000	149.225 5.8750	111.125 4.3750	1150000 258000	0.41	1.66	2.47	171000 38500	119000 26800	298000 67000	1.43
139.700 5.5000	215.900 8.5000	106.362 4.1875	80.962 3.1875	665000 150000	0.49	1.38	2.06	99000 22300	82600 18600	172000 38800	1.20
139.700 5.5000	215.900 8.5000	106.362 4.1875	80.962 3.1875	665000 150000	0.49	1.38	2.06	99000 22300	82600 18600	172000 38800	1.20
139.700 5.5000	222.250 8.7500	75.692 2.9800	53.975 2.1250	510000 115000	0.44	1.54	2.30	75900 17100	56800 12800	132000 29700	1.34
139.700 5.5000	228.600 9.0000	123.825 4.8750	98.425 3.8750	906000 204000	0.42	1.60	2.39	135000 30300	97200 21800	235000 52800	1.39
139.700 5.5000	228.600 9.0000	123.825 4.8750	98.425 3.8750	906000 204000	0.42	1.60	2.39	135000 30300	97200 21800	235000 52800	1.39
139.700 5.5000	236.538 9.3125	131.762 5.1875	106.362 4.1875	1040000 234000	0.32	2.12	3.15	155000 34800	84500 19000	269000 60600	1.83
139.700 5.5000	241.300 9.5000	131.762 5.1875	106.362 4.1875	897000 202000	0.44	1.53	2.27	134000 30000	101000 22700	232000 52300	1.32
139.700 5.5000	254.000 10.0000	149.225 5.8750	111.125 4.3750	1150000 258000	0.41	1.66	2.47	171000 38500	119000 26800	298000 67000	1.43
139.700 5.5000	307.975 12.1250	200.025 7.8750	155.575 6.1250	2010000 451000	0.33	2.07	3.08	299000 67200	167000 37500	520000 117000	1.79
139.700 5.5000	307.975 12.1250	200.025 7.8750	155.575 6.1250	2010000 451000	0.33	2.07	3.08	299000 67200	167000 37500	520000 117000	1.79
142.875 5.6250	200.025 7.8750	87.315 3.4376	73.025 2.8750	499000 112000	0.34	2.01	2.99	74300 16700	42800 9610	129000 29100	1.74

<sup>(1)</sup>Based on  $1 \times 10^6$  revolutions  $L_{10}$  life, for the ISO life-calculation method.  $C_{1(2)}$  is the double-row radial value.

<sup>(2)</sup>Consult your Timken engineer for instructions on use or review the Timken Engineering Manual on [timken.com/catalogs](http://timken.com/catalogs).

<sup>(3)</sup>Based on  $90 \times 10^6$  revolutions  $L_{10}$  life, for The Timken Company life-calculation method.  $C_{90}$  and  $C_{a90}$  are radial and thrust values for a single row.  $C_{90(2)}$  is the double-row radial value.

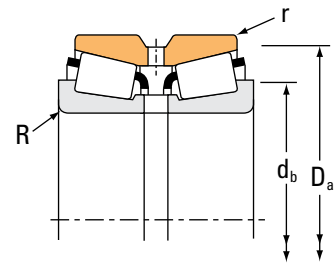
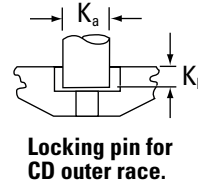
Part Number		Dimensions						Geometry Factors			Bearing Weight
Inner	Outer	Shaft		Housing		Pin		G <sub>1</sub>	G <sub>2</sub>	C <sub>g</sub>	
		Max. Shaft Fillet Radius R <sup>(4)</sup>	Backing Shoulder Dia. d <sub>b</sub>	Max. Housing Fillet Radius r <sup>(4)</sup>	Backing Shoulder Dia. D <sub>a</sub>	K <sub>a</sub>	K <sub>b</sub>				
		mm in.	mm in.	mm in.	mm in.	mm in.	mm in.				kg lbs.
95525	95927CD	9.7 0.38	166.0 6.54	1.5 0.06	217.0 8.54	22.23 0.88	8.73 0.34	453.9	59.4	0.1323	23.65 52.14
95528	95927CD	4.8 0.19	157.0 6.18	1.5 0.06	217.0 8.54	22.23 0.88	8.73 0.34	453.9	59.4	0.1323	23.89 52.67
48393	48320D	3.5 0.14	151.0 5.94	0.8 0.03	184.0 7.24	– –	– –	403.8	105.1	0.1209	6.99 15.41
74537	74851CD	3.5 0.14	155.0 6.10	1.5 0.06	208.0 8.19	19.05 0.75	7.13 0.28	362.9	68.5	0.1338	13.21 29.09
896	892CD	3.5 0.14	156.0 6.14	1.5 0.06	216.0 8.50	22.23 0.88	7.13 0.28	430.5	78.3	0.1355	18.81 41.47
99537	99102CD	7.0 0.28	167.0 6.57	1.5 0.06	238.0 9.37	22.23 0.88	7.95 0.31	555.5	73.5	0.1459	30.76 67.79
74550	74851CD	3.5 0.14	158.0 6.22	1.5 0.06	208.0 8.19	19.05 0.75	7.13 0.28	362.9	68.5	0.1338	12.73 28.06
74550A	74851CD	6.4 0.25	166.0 6.54	1.5 0.06	208.0 8.19	19.05 0.75	7.13 0.28	362.9	68.5	0.1338	12.71 28.01
73551	73876CD	3.5 0.14	156.0 6.14	2.3 0.09	207.0 8.15	11.11 0.44	6.35 0.25	244.4	82.0	0.1122	9.36 20.61
898	892CD	3.5 0.14	160.0 6.30	1.5 0.06	216.0 8.50	22.23 0.88	7.13 0.28	430.5	78.3	0.1355	18.09 39.89
898A	892CD	6.4 0.25	165.0 6.50	1.5 0.06	216.0 8.50	22.23 0.88	7.13 0.28	430.5	78.3	0.1355	17.99 39.67
HM231132	HM231111CD	3.5 0.14	160.0 6.30	1.5 0.06	224.0 8.82	22.23 0.88	7.92 0.31	532.8	85.9	0.1327	21.68 47.79
82550	82951CD	3.5 0.14	161.0 6.34	1.5 0.06	226.0 8.90	22.23 0.88	8.73 0.34	460.5	81.1	0.1405	23.09 50.93
99550	99102CD	7.0 0.28	170.0 6.69	1.5 0.06	238.0 9.37	22.23 0.88	7.95 0.31	555.5	73.5	0.1459	30.15 66.47
HH234031	HH234011CD	9.7 0.38	180.0 7.09	2.3 0.09	285.0 11.24	28.58 1.13	10.31 0.41	718.4	62.1	0.1157	65.90 145.26
HH234032	HH234011CD	9.7 0.38	180.0 7.09	2.3 0.09	285.0 11.24	28.58 1.13	10.31 0.41	718.4	62.1	0.1157	66.18 145.90
48685	48620D	3.5 0.14	158.0 6.22	0.8 0.03	193.0 7.60	– –	– –	439.6	130.5	0.1261	8.02 17.68

<sup>(4)</sup>These maximum fillet radii will be cleared by bearing corners.  
NOTE: For spacer configuration information, contact your Timken engineer.

# TAPERED ROLLER BEARINGS

## DOUBLE-ROW • TYPE TDO

### TYPE TDO



Bearing Dimensions				Load Ratings							
Bore d	O.D. D	Width T	Double Outer Ring Width C	Dynamic <sup>(1)</sup>				Dynamic <sup>(3)</sup>			
				C <sub>1(2)</sub>	e	Y <sub>1</sub>	Y <sub>2</sub>	C <sub>90</sub>	C <sub>a90</sub>	C <sub>90(2)</sub>	K
mm in.	mm in.	mm in.	mm in.	N lbf				N lbf	N lbf	N lbf	
142.875 5.6250	222.250 8.7500	75.692 2.9800	53.975 2.1250	510000 115000	0.44	1.54	2.30	75900 17100	56800 12800	132000 29700	1.34
142.875 5.6250	241.300 9.5000	131.762 5.1875	106.362 4.1875	897000 202000	0.44	1.53	2.27	134000 30000	101000 22700	232000 52300	1.32
146.050 5.7500	193.675 7.6250	65.085 2.5624	53.975 2.1250	342000 76900	0.37	1.83	2.73	50900 11400	32100 7220	88600 19900	1.59
146.050 5.7500	236.538 9.3125	131.762 5.1875	106.362 4.1875	1040000 234000	0.32	2.12	3.15	155000 34800	84500 19000	269000 60600	1.83
146.050 5.7500	241.300 9.5000	131.762 5.1875	106.362 4.1875	897000 202000	0.44	1.53	2.27	134000 30000	101000 22700	232000 52300	1.32
146.050 5.7500	244.475 9.6250	107.950 4.2500	79.375 3.1250	699000 157000	0.35	1.92	2.86	104000 23400	62700 14100	181000 40800	1.66
146.050 5.7500	254.000 10.0000	149.225 5.8750	111.125 4.3750	1150000 258000	0.41	1.66	2.47	171000 38500	119000 26800	298000 67000	1.43
149.225 5.8750	236.538 9.3125	131.762 5.1875	106.362 4.1875	1040000 234000	0.32	2.12	3.15	155000 34800	84500 19000	269000 60600	1.83
149.225 5.8750	236.538 9.3125	131.762 5.1875	106.362 4.1875	1040000 234000	0.32	2.12	3.15	155000 34800	84500 19000	269000 60600	1.83
149.225 5.8750	241.300 9.5000	131.762 5.1875	106.362 4.1875	897000 202000	0.44	1.53	2.27	134000 30000	101000 22700	232000 52300	1.32
149.225 5.8750	254.000 10.0000	149.225 5.8750	111.125 4.3750	1150000 258000	0.41	1.66	2.47	171000 38500	119000 26800	298000 67000	1.43
150.000 5.9055	244.475 9.6250	107.950 4.2500	79.375 3.1250	699000 157000	0.35	1.92	2.86	104000 23400	62700 14100	181000 40800	1.66
150.812 5.9375	244.475 9.6250	107.950 4.2500	79.375 3.1250	699000 157000	0.35	1.92	2.86	104000 23400	62700 14100	181000 40800	1.66
152.400 6.0000	203.200 8.0000	92.075 3.6250	79.375 3.1250	493000 111000	0.35	1.94	2.89	73400 16500	43700 9810	128000 28700	1.68
152.400 6.0000	222.250 8.7500	100.010 3.9374	76.200 3.0000	607000 136000	0.33	2.03	3.02	90400 20300	51500 11600	157000 35400	1.76
152.400 6.0000	244.475 9.6250	107.950 4.2500	79.375 3.1250	699000 157000	0.35	1.92	2.86	104000 23400	62700 14100	181000 40800	1.66
152.400 6.0000	254.000 10.0000	149.225 5.8750	111.125 4.3750	1150000 258000	0.41	1.66	2.47	171000 38500	119000 26800	298000 67000	1.43

<sup>(1)</sup>Based on 1 x 10<sup>6</sup> revolutions L<sub>10</sub> life, for the ISO life-calculation method. C<sub>1(2)</sub> is the double-row radial value.

<sup>(2)</sup>Consult your Timken engineer for instructions on use or review the Timken Engineering Manual on [timken.com/catalogs](http://timken.com/catalogs).

<sup>(3)</sup>Based on 90 x 10<sup>6</sup> revolutions L<sub>10</sub> life, for The Timken Company life-calculation method. C<sub>90</sub> and C<sub>a90</sub> are radial and thrust values for a single row. C<sub>90(2)</sub> is the double-row radial value.

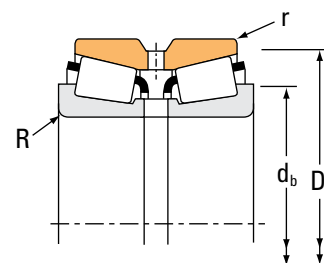
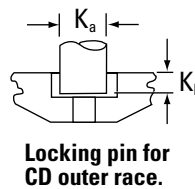
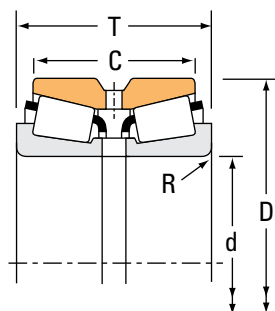
Part Number		Dimensions						Geometry Factors			Bearing Weight
Inner	Outer	Shaft		Housing		Pin		G <sub>1</sub>	G <sub>2</sub>	C <sub>G</sub>	
		Max. Shaft Fillet Radius R <sup>(4)</sup>	Backing Shoulder Dia. d <sub>b</sub>	Max. Housing Fillet Radius r <sup>(4)</sup>	Backing Shoulder Dia. D <sub>a</sub>	K <sub>a</sub>	K <sub>b</sub>				
		mm in.	mm in.	mm in.	mm in.	mm in.	mm in.				kg lbs.
73562	73876CD	3.5 0.14	159.0 6.26	2.3 0.09	207.0 8.15	11.11 0.44	6.35 0.25	244.4	82.0	0.1122	8.94 19.70
82562	82951CD	3.5 0.14	163.0 6.42	1.5 0.06	226.0 8.90	22.23 0.88	8.73 0.34	460.5	81.1	0.1405	22.49 49.58
36690	36620D	1.5 0.06	155.0 6.10	0.8 0.03	188.0 7.40	– –	– –	366.1	152.5	0.1768	4.89 10.80
HM231140	HM231111CD	3.5 0.14	164.0 6.46	1.5 0.06	224.0 8.82	22.23 0.88	7.92 0.31	532.8	85.9	0.1327	20.26 44.66
82576	82951CD	3.5 0.14	166.0 6.54	1.5 0.06	226.0 8.90	22.23 0.88	8.73 0.34	460.5	81.1	0.1405	21.80 48.09
81575	81963CD	3.5 0.14	166.1 6.54	1.5 0.06	229.1 9.02	19.05 0.75	7.95 0.31	413.0	98.4	0.1250	17.83 39.30
99575	99102CD	7.0 0.28	175.0 6.89	1.5 0.06	238.0 9.37	22.23 0.88	7.95 0.31	555.5	73.5	0.1459	28.57 62.96
HM231148	HM231111CD	6.4 0.25	172.0 6.77	1.5 0.06	224.0 8.82	22.23 0.88	7.92 0.31	532.8	85.9	0.1327	19.50 42.99
HM231149	HM231111CD	3.5 0.14	167.0 6.57	1.5 0.06	224.0 8.82	22.23 0.88	7.92 0.31	532.8	85.9	0.1327	19.60 43.22
82587	82951CD	3.5 0.14	169.0 6.65	1.5 0.06	226.0 8.90	22.23 0.88	8.73 0.34	460.5	81.1	0.1405	20.98 46.27
99587	99102CD	7.0 0.28	181.0 7.13	1.5 0.06	238.0 9.37	22.23 0.88	7.95 0.31	555.5	73.5	0.1459	27.99 61.69
81590	81963CD	3.5 0.14	168.9 6.65	1.5 0.06	229.1 9.02	19.05 0.75	7.95 0.31	413.0	98.4	0.1250	17.18 37.89
81593	81963CD	3.5 0.14	168.9 6.65	1.5 0.06	229.1 9.02	19.05 0.75	7.95 0.31	413.0	98.4	0.1250	16.99 37.47
LM330448	LM330410D	3.3 0.13	166.0 6.54	0.8 0.03	197.0 7.76	– –	– –	456.5	134.8	0.1289	7.55 16.63
M231649	M231610CD	3.5 0.14	169.0 6.65	0.8 0.03	213.0 8.39	19.05 0.75	7.13 0.28	486.5	120.1	0.1300	11.77 25.96
81600	81963CD	3.5 0.14	170.9 6.73	1.5 0.06	229.1 9.02	19.05 0.75	7.95 0.31	413.0	98.4	0.1250	17.20 37.90
99600	99102CD	7.0 0.28	181.0 7.13	1.5 0.06	238.0 9.37	22.23 0.88	7.95 0.31	555.5	73.5	0.1459	26.98 59.49

<sup>(4)</sup>These maximum fillet radii will be cleared by bearing corners.  
NOTE: For spacer configuration information, contact your Timken engineer.

# TAPERED ROLLER BEARINGS

## DOUBLE-ROW • TYPE TDO

### TYPE TDO



Bearing Dimensions				Load Ratings							
Bore d	O.D. D	Width T	Double Outer Ring Width C	Dynamic <sup>(1)</sup>		Factors <sup>(2)</sup>		Dynamic <sup>(3)</sup>			Factors <sup>(2)</sup>
				C <sub>1(2)</sub>	e	Y <sub>1</sub>	Y <sub>2</sub>	C <sub>90</sub>	C <sub>a90</sub>	C <sub>90(2)</sub>	K
mm in.	mm in.	mm in.	mm in.	N lbf				N lbf	N lbf	N lbf	
152.400 6.0000	268.288 10.5625	160.338 6.3125	125.412 4.9375	1370000 307000	0.39	1.74	2.59	203000 45700	135000 30300	354000 79600	1.51
152.400 6.0000	307.975 12.1250	200.025 7.8750	146.050 5.7500	1830000 412000	0.33	2.07	3.08	273000 61400	152000 34300	475000 107000	1.79
152.400 6.0000	307.975 12.1250	200.025 7.8750	155.575 6.1250	2010000 451000	0.33	2.07	3.08	299000 67200	167000 37500	520000 117000	1.79
152.400 6.0000	307.975 12.1250	200.025 7.8750	155.575 6.1250	2130000 478000	0.33	2.07	3.08	316000 71100	177000 39700	551000 124000	1.79
153.988 6.0625	244.475 9.6250	107.950 4.2500	79.375 3.1250	699000 157000	0.35	1.92	2.86	104000 23400	62700 14100	181000 40800	1.66
158.750 6.2500	225.425 8.8750	85.725 3.3750	69.850 2.7500	528000 119000	0.38	1.76	2.62	78600 17700	51600 11600	137000 30800	1.52
159.950 6.2973	244.475 9.6250	107.950 4.2500	79.375 3.1250	699000 157000	0.35	1.92	2.86	104000 23400	62700 14100	181000 40800	1.66
159.950 6.2973	244.475 9.6250	107.950 4.2500	79.375 3.1250	699000 157000	0.35	1.92	2.86	104000 23400	62700 14100	181000 40800	1.66
160.325 6.3120	288.925 11.3750	142.875 5.6250	111.125 4.3750	1700000 382000	0.32	2.12	3.15	253000 56900	138000 31100	441000 99100	1.83
165.100 6.5000	225.425 8.8750	85.725 3.3750	69.850 2.7500	528000 119000	0.38	1.76	2.62	78600 17700	51600 11600	137000 30800	1.52
165.100 6.5000	247.650 9.7500	103.188 4.0625	84.138 3.3125	705000 159000	0.44	1.54	2.29	105000 23600	79000 17800	183000 41100	1.33
165.100 6.5000	254.000 10.0000	101.600 4.0000	76.200 3.0000	893000 201000	0.32	2.12	3.15	133000 29900	72600 16300	231000 52000	1.83
165.100 6.5000	288.925 11.3750	142.875 5.6250	111.125 4.3750	1150000 258000	0.47	1.44	2.15	171000 38500	137000 30800	298000 67000	1.25
165.100 6.5000	288.925 11.3750	142.875 5.6250	111.125 4.3750	1700000 382000	0.32	2.12	3.15	253000 56900	138000 31100	441000 99100	1.83
166.688 6.5625	225.425 8.8750	85.725 3.3750	69.850 2.7500	528000 119000	0.38	1.76	2.62	78600 17700	51600 11600	137000 30800	1.52
168.275 6.6250	247.650 9.7500	103.188 4.0625	84.138 3.3125	705000 159000	0.44	1.54	2.29	105000 23600	79000 17800	183000 41100	1.33
170.000 6.6929	254.000 10.0000	101.600 4.0000	76.200 3.0000	893000 201000	0.32	2.12	3.15	133000 29900	72600 16300	231000 52000	1.83

<sup>(1)</sup>Based on 1 x 10<sup>6</sup> revolutions L<sub>10</sub> life, for the ISO life-calculation method. C<sub>1(2)</sub> is the double-row radial value.

<sup>(2)</sup>Consult your Timken engineer for instructions on use or review the Timken Engineering Manual on [timken.com/catalogs](http://timken.com/catalogs).

<sup>(3)</sup>Based on 90 x 10<sup>6</sup> revolutions L<sub>10</sub> life, for The Timken Company life-calculation method. C<sub>90</sub> and C<sub>a90</sub> are radial and thrust values for a single row. C<sub>90(2)</sub> is the double-row radial value.

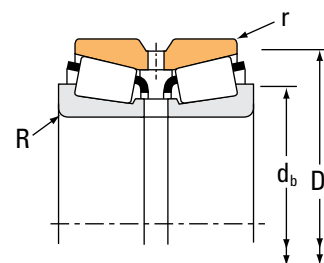
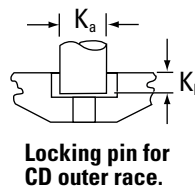
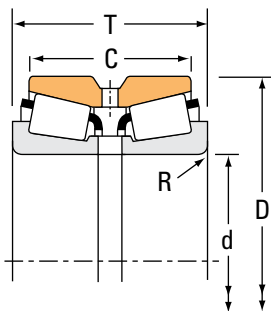
Part Number		Dimensions						Geometry Factors			Bearing Weight
Inner	Outer	Shaft		Housing		Pin		G <sub>1</sub>	G <sub>2</sub>	C <sub>g</sub>	
		Max. Shaft Fillet Radius R <sup>(4)</sup>	Backing Shoulder Dia. d <sub>b</sub>	Max. Housing Fillet Radius r <sup>(4)</sup>	Backing Shoulder Dia. D <sub>a</sub>	K <sub>a</sub>	K <sub>b</sub>				
		mm in.	mm in.	mm in.	mm in.	mm in.	mm in.				kg lbs.
EE107060	107105CD	6.4 0.25	181.0 7.13	1.5 0.06	249.4 9.82	28.58 1.13	10.34 0.41	606.1	76.3	0.1163	34.82 76.74
EE450601	451215CD	9.7 0.38	189.0 7.44	2.3 0.09	274.8 10.82	28.58 1.13	11.91 0.47	747.4	76.3	0.1176	60.77 133.98
HH234048	HH234011CD	9.7 0.38	191.0 7.52	2.3 0.09	285.0 11.24	28.58 1.13	10.31 0.41	718.4	62.1	0.1157	61.38 135.32
HH234049	HH234011CD	9.7 0.38	191.0 7.52	2.3 0.09	285.0 11.24	28.58 1.13	10.31 0.41	718.4	62.1	0.1157	61.66 135.93
81606	81963CD	3.5 0.14	172.0 6.77	1.5 0.06	229.1 9.02	19.05 0.75	7.95 0.31	413.0	98.4	0.1250	16.54 36.46
46780	46720CD	3.5 0.14	176.0 6.93	0.8 0.03	218.0 8.58	15.88 0.63	5.56 0.22	572.0	174.7	0.1432	10.58 23.34
81629	81963CD	3.5 0.14	176.0 6.93	1.5 0.06	229.1 9.02	19.05 0.75	7.95 0.31	413.0	98.4	0.1250	15.22 33.56
81630	81963CD	3.5 0.14	176.0 6.93	1.5 0.06	229.1 9.02	19.05 0.75	7.95 0.31	413.0	98.4	0.1250	15.40 33.95
HM237532	HM237510CD	7.0 0.28	192.0 7.56	1.5 0.06	271.5 10.69	22.23 0.88	8.73 0.34	751.2	101.5	0.1168	37.00 81.55
46790	46720CD	3.5 0.14	181.0 7.13	0.8 0.03	218.0 8.58	15.88 0.63	5.56 0.22	572.0	174.7	0.1432	9.54 21.02
67780	67720CD	3.5 0.14	185.0 7.28	0.8 0.03	240.0 9.45	19.05 0.75	7.13 0.28	622.3	122.6	0.1214	16.76 36.96
M235145	M235113CD	4.8 0.19	185.0 7.28	1.5 0.06	240.0 9.45	19.05 0.75	7.95 0.31	531.4	107.5	0.1037	16.54 36.44
94649	94114CD	7.0 0.28	197.0 7.76	1.5 0.06	272.0 10.71	22.23 0.88	10.34 0.41	692.3	93.9	0.1287	36.99 81.56
HM237535	HM237510CD	7.0 0.28	195.0 7.68	1.5 0.06	271.5 10.69	22.23 0.88	8.73 0.34	751.2	101.5	0.1168	35.79 78.88
46792	46720CD	3.5 0.14	182.0 7.17	0.8 0.03	218.0 8.58	15.88 0.63	5.56 0.22	572.0	174.7	0.1432	9.28 20.44
67782	67720CD	3.5 0.14	187.0 7.36	0.8 0.03	240.0 9.45	19.05 0.75	7.13 0.28	622.3	122.6	0.1214	16.02 35.34
M235149	M235113CD	4.8 0.19	189.0 7.44	1.5 0.06	240.0 9.45	19.05 0.75	7.95 0.31	531.4	107.5	0.1037	15.43 34.00

<sup>(4)</sup>These maximum fillet radii will be cleared by bearing corners.  
NOTE: For spacer configuration information, contact your Timken engineer.

# TAPERED ROLLER BEARINGS

## DOUBLE-ROW • TYPE TDO

### TYPE TDO



Bearing Dimensions				Load Ratings							
Bore d	O.D. D	Width T	Double Outer Ring Width C	Dynamic <sup>(1)</sup>		Factors <sup>(2)</sup>		Dynamic <sup>(3)</sup>			Factors <sup>(2)</sup>
				C <sub>1(2)</sub>	e	Y <sub>1</sub>	Y <sub>2</sub>	C <sub>90</sub>	C <sub>a90</sub>	C <sub>90(2)</sub>	K
mm in.	mm in.	mm in.	mm in.	N lbf				N lbf	N lbf	N lbf	
171.450 6.7500	288.925 11.3750	142.875 5.6250	111.125 4.3750	1150000 258000	0.47	1.44	2.15	171000 38500	137000 30800	298000 67000	1.25
174.625 6.8750	247.650 9.7500	103.188 4.0625	84.138 3.3125	705000 159000	0.44	1.54	2.29	105000 23600	79000 17800	183000 41100	1.33
174.625 6.8750	247.650 9.7500	103.188 4.0625	84.138 3.3125	705000 159000	0.44	1.54	2.29	105000 23600	79000 17800	183000 41100	1.33
174.625 6.8750	288.925 11.3750	142.875 5.6250	111.125 4.3750	1150000 258000	0.47	1.44	2.15	171000 38500	137000 30800	298000 67000	1.25
174.625 6.8750	288.925 11.3750	142.875 5.6250	111.125 4.3750	1700000 382000	0.32	2.12	3.15	253000 56900	138000 31100	441000 99100	1.83
177.800 7.0000	227.012 8.9375	66.672 2.6249	52.388 2.0625	364000 81800	0.44	1.53	2.28	54200 12200	40900 9190	94400 21200	1.33
177.800 7.0000	247.650 9.7500	103.188 4.0625	84.138 3.3125	705000 159000	0.44	1.54	2.29	105000 23600	79000 17800	183000 41100	1.33
177.800 7.0000	247.650 9.7500	103.188 4.0625	84.138 3.3125	705000 159000	0.44	1.54	2.29	105000 23600	79000 17800	183000 41100	1.33
177.800 7.0000	269.875 10.6250	119.062 4.6875	93.662 3.6875	884000 199000	0.33	2.03	3.02	132000 29600	74900 16800	229000 51500	1.76
177.800 7.0000	288.925 11.3750	142.875 5.6250	111.125 4.3750	1150000 258000	0.47	1.44	2.15	171000 38500	137000 30800	298000 67000	1.25
177.800 7.0000	288.925 11.3750	142.875 5.6250	111.125 4.3750	1700000 382000	0.32	2.12	3.15	253000 56900	138000 31100	441000 99100	1.83
177.800 7.0000	288.925 11.3750	142.875 5.6250	111.125 4.3750	1700000 382000	0.32	2.12	3.15	253000 56900	138000 31100	441000 99100	1.83
177.800 7.0000	320.675 12.6250	185.738 7.3125	138.112 5.4375	1660000 374000	0.40	1.69	2.51	247000 55600	169000 38100	431000 96900	1.46
177.800 7.0000	320.675 12.6250	185.738 7.3125	138.112 5.4375	1830000 410000	0.32	2.12	3.15	272000 61100	148000 33400	473000 106000	1.83
179.975 7.0856	317.500 12.5000	146.050 5.7500	111.125 4.3750	1270000 286000	0.52	1.29	1.92	190000 42600	170000 38200	330000 74200	1.12
184.150 7.2500	266.700 10.5000	103.188 4.0625	84.138 3.3125	725000 163000	0.48	1.41	2.11	108000 24300	88200 19800	188000 42300	1.22
187.325 7.3750	266.700 10.5000	103.188 4.0625	84.138 3.3125	725000 163000	0.48	1.41	2.11	108000 24300	88200 19800	188000 42300	1.22

<sup>(1)</sup>Based on 1 x 10<sup>6</sup> revolutions L<sub>10</sub> life, for the ISO life-calculation method. C<sub>1(2)</sub> is the double-row radial value.

<sup>(2)</sup>Consult your Timken engineer for instructions on use or review the Timken Engineering Manual on [timken.com/catalogs](http://timken.com/catalogs).

<sup>(3)</sup>Based on 90 x 10<sup>6</sup> revolutions L<sub>10</sub> life, for The Timken Company life-calculation method. C<sub>90</sub> and C<sub>a90</sub> are radial and thrust values for a single row. C<sub>90(2)</sub> is the double-row radial value.



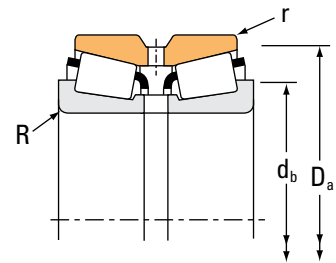
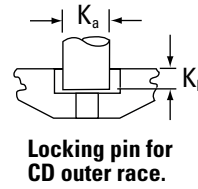
Part Number		Dimensions						Geometry Factors			Bearing Weight
Inner	Outer	Shaft		Housing		Pin		G <sub>1</sub>	G <sub>2</sub>	C <sub>G</sub>	
		Max. Shaft Fillet Radius R <sup>(4)</sup>	Backing Shoulder Dia. d <sub>b</sub>	Max. Housing Fillet Radius r <sup>(4)</sup>	Backing Shoulder Dia. D <sub>a</sub>	K <sub>a</sub>	K <sub>b</sub>				
		mm in.	mm in.	mm in.	mm in.	mm in.	mm in.				kg lbs.
94675	94114CD	7.0 0.28	202.0 7.95	1.5 0.06	272.0 10.71	22.23 0.88	10.34 0.41	692.3	93.9	0.1287	35.08 77.34
67786	67720CD	8.0 0.31	200.0 7.87	0.8 0.03	240.0 9.45	19.05 0.75	7.13 0.28	622.3	122.6	0.1214	14.61 32.20
67787	67720CD	3.5 0.14	192.0 7.56	0.8 0.03	240.0 9.45	19.05 0.75	7.13 0.28	622.3	122.6	0.1214	14.69 32.40
94687	94114CD	7.0 0.28	204.0 8.03	1.5 0.06	272.0 10.71	22.23 0.88	10.34 0.41	692.3	93.9	0.1287	34.23 75.46
HM237542	HM237510CD	7.0 0.28	202.0 7.95	1.5 0.06	271.5 10.69	22.23 0.88	8.73 0.34	751.2	101.5	0.1168	33.13 73.04
36990	36920CD	1.5 0.06	188.0 7.40	0.8 0.03	221.0 8.70	11.11 0.44	4.65 0.18	514.8	241.1	0.1434	6.13 13.54
67790	67720CD	3.5 0.14	194.0 7.64	0.8 0.03	240.0 9.45	19.05 0.75	7.13 0.28	622.3	122.6	0.1214	14.01 30.87
67791	67720CD	10.5 0.41	208.0 8.19	0.8 0.03	240.0 9.45	19.05 0.75	7.13 0.28	622.3	122.6	0.1214	13.81 30.46
M238840	M238810CD	3.5 0.14	198.0 7.80	1.5 0.06	256.0 10.08	19.05 0.75	7.95 0.31	788.3	118.1	0.1201	22.99 50.70
94700	94114CD	7.0 0.28	207.0 8.15	1.5 0.06	272.0 10.71	22.23 0.88	10.34 0.41	692.3	93.9	0.1287	33.31 73.47
HM237545	HM237510CD	7.0 0.28	205.0 8.07	1.5 0.06	271.5 10.69	22.23 0.88	8.73 0.34	751.2	101.5	0.1168	32.29 71.19
HM237545H	HM237510CD	7.0 0.28	207.0 8.15	1.5 0.06	271.5 10.69	22.23 0.88	8.73 0.34	751.2	101.5	0.1168	32.42 71.49
EE222070	222127CD	3.5 0.14	204.0 8.03	1.5 0.06	298.0 11.73	28.58 1.13	11.91 0.47	947.4	104.7	0.1362	60.47 133.30
H239640	H239612CD	3.5 0.14	202.0 7.95	1.5 0.06	301.0 11.84	28.58 1.13	10.31 0.41	905.7	90.3	0.1242	57.18 126.05
93708	93127CD	3.5 0.14	209.0 8.23	1.5 0.06	298.5 11.75	22.23 0.88	10.31 0.41	912.5	126.1	0.1460	46.95 103.54
67883	67820CD	3.5 0.14	204.0 8.03	0.8 0.03	259.0 10.20	22.23 0.88	7.13 0.28	727.9	146.6	0.1310	18.18 40.07
67884	67820CD	3.5 0.14	206.0 8.11	0.8 0.03	259.0 10.20	22.23 0.88	7.13 0.28	727.9	146.6	0.1310	17.42 38.39

<sup>(4)</sup>These maximum fillet radii will be cleared by bearing corners.  
NOTE: For spacer configuration information, contact your Timken engineer.

# TAPERED ROLLER BEARINGS

## DOUBLE-ROW • TYPE TDO

### TYPE TDO



Bearing Dimensions				Load Ratings							
Bore d	O.D. D	Width T	Double Outer Ring Width C	Dynamic <sup>(1)</sup>				Dynamic <sup>(3)</sup>			
				C <sub>1(2)</sub>	e	Y <sub>1</sub>	Y <sub>2</sub>	C <sub>90</sub>	C <sub>a90</sub>	C <sub>90(2)</sub>	K
mm in.	mm in.	mm in.	mm in.	N lbf				N lbf	N lbf	N lbf	
187.325 7.3750	269.875 10.6250	119.062 4.6875	93.662 3.6875	955000 215000	0.33	2.03	3.02	142000 32000	80900 18200	247000 55600	1.76
187.325 7.3750	320.675 12.6250	185.738 7.3125	138.112 5.4375	1830000 410000	0.32	2.12	3.15	272000 61100	148000 33400	473000 106000	1.83
190.500 7.5000	266.700 10.5000	103.188 4.0625	84.138 3.3125	725000 163000	0.48	1.41	2.11	108000 24300	88200 19800	188000 42300	1.22
190.500 7.5000	317.500 12.5000	146.050 5.7500	111.125 4.3750	1270000 286000	0.52	1.29	1.92	190000 42600	170000 38200	330000 74200	1.12
190.500 7.5000	368.300 14.5000	193.675 7.6250	136.525 5.3750	2030000 457000	0.40	1.68	2.50	303000 68100	208000 46800	527000 118000	1.45
192.088 7.5625	266.700 10.5000	103.188 4.0625	84.138 3.3125	725000 163000	0.48	1.41	2.11	108000 24300	88200 19800	188000 42300	1.22
196.850 7.7500	257.175 10.1250	85.725 3.3750	66.675 2.6250	554000 125000	0.45	1.51	2.25	82500 18600	63100 14200	144000 32300	1.31
196.850 7.7500	317.500 12.5000	146.050 5.7500	111.125 4.3750	1270000 286000	0.52	1.29	1.92	190000 42600	170000 38200	330000 74200	1.12
200.025 7.8750	292.100 11.5000	125.415 4.9376	101.600 4.0000	1040000 235000	0.33	2.03	3.02	156000 35000	88500 19900	271000 60900	1.76
200.025 7.8750	317.500 12.5000	146.050 5.7500	111.125 4.3750	1270000 286000	0.52	1.29	1.92	190000 42600	170000 38200	330000 74200	1.12
200.025 7.8750	333.375 13.1250	149.225 5.8750	114.300 4.5000	1600000 359000	0.44	1.54	2.29	238000 53400	179000 40200	414000 93000	1.33
200.025 7.8750	384.175 15.1250	238.125 9.3750	193.675 7.6250	2920000 656000	0.33	2.03	3.02	434000 97600	247000 55600	756000 170000	1.76
200.025 7.8750	384.175 15.1250	238.125 9.3750	193.675 7.6250	3080000 693000	0.33	2.03	3.02	459000 103000	261000 58800	800000 180000	1.76
203.200 8.0000	282.575 11.1250	101.600 4.0000	82.550 3.2500	875000 197000	0.51	1.33	1.97	130000 29300	114000 25500	227000 51000	1.15
203.200 8.0000	292.100 11.5000	109.538 4.3125	84.138 3.3125	1170000 263000	0.40	1.69	2.51	174000 39100	119000 26800	303000 68200	1.46
203.200 8.0000	292.100 11.5000	125.415 4.9376	101.600 4.0000	1040000 235000	0.33	2.03	3.02	156000 35000	88500 19900	271000 60900	1.76
203.200 8.0000	292.100 11.5000	125.415 4.9376	101.600 4.0000	1200000 269000	0.33	2.03	3.02	178000 40100	102000 22800	311000 69800	1.76

<sup>(1)</sup>Based on 1 x 10<sup>6</sup> revolutions L<sub>10</sub> life, for the ISO life-calculation method. C<sub>1(2)</sub> is the double-row radial value.

<sup>(2)</sup>Consult your Timken engineer for instructions on use or review the Timken Engineering Manual on [timken.com/catalogs](http://timken.com/catalogs).

<sup>(3)</sup>Based on 90 x 10<sup>6</sup> revolutions L<sub>10</sub> life, for The Timken Company life-calculation method. C<sub>90</sub> and C<sub>a90</sub> are radial and thrust values for a single row. C<sub>90(2)</sub> is the double-row radial value.

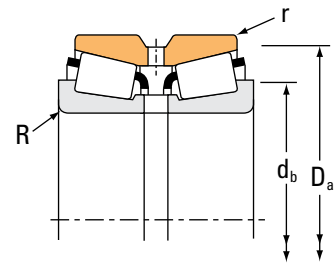
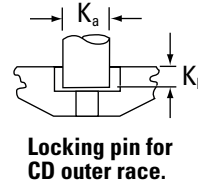
Part Number		Dimensions						Geometry Factors			Bearing Weight
Inner	Outer	Shaft		Housing		Pin		G <sub>1</sub>	G <sub>2</sub>	C <sub>g</sub>	
		Max. Shaft Fillet Radius R <sup>(4)</sup>	Backing Shoulder Dia. d <sub>b</sub>	Max. Housing Fillet Radius r <sup>(4)</sup>	Backing Shoulder Dia. D <sub>a</sub>	K <sub>a</sub>	K <sub>b</sub>				
		mm in.	mm in.	mm in.	mm in.	mm in.	mm in.				kg lbs.
M238849	M238810CD	3.5 0.14	205.0 8.07	1.5 0.06	256.0 10.08	19.05 0.75	7.95 0.31	788.3	118.1	0.1201	20.41 44.98
H239649	H239612CD	5.5 0.22	214.0 8.43	1.5 0.06	301.0 11.84	28.58 1.13	10.31 0.41	905.7	90.3	0.1242	53.16 117.18
67885	67820CD	3.5 0.14	209.0 8.23	0.8 0.03	259.0 10.20	22.23 0.88	7.13 0.28	727.9	146.6	0.1310	16.70 36.81
93750	93127CD	4.3 0.17	218.0 8.58	1.5 0.06	298.5 11.75	22.23 0.88	10.31 0.41	912.5	126.1	0.1460	43.25 95.35
EE420751	421451CD	6.4 0.25	227.0 8.94	1.5 0.06	334.4 13.16	25.40 1.00	11.91 0.47	1150.5	128.2	0.1450	84.09 185.38
67887	67820CD	10.5 0.41	223.0 8.78	0.8 0.03	259.0 10.20	22.23 0.88	7.13 0.28	727.9	146.6	0.1310	15.86 34.97
LM739749	LM739710CD	3.5 0.14	213.0 8.39	0.8 0.03	251.0 9.88	14.29 0.56	6.35 0.25	761.7	232.3	0.1296	11.13 24.55
93775	93127CD	4.3 0.17	223.0 8.78	1.5 0.06	298.5 11.75	22.23 0.88	10.31 0.41	912.5	126.1	0.1460	41.22 90.89
M241543	M241510CD	3.5 0.14	219.0 8.62	1.5 0.06	279.0 10.98	19.05 0.75	8.73 0.34	954.1	127.9	0.1279	26.22 57.82
93787	93127CD	4.3 0.17	225.0 8.86	1.5 0.06	298.5 11.75	22.23 0.88	10.31 0.41	912.5	126.1	0.1460	40.20 88.66
HM743337	HM743310CD	6.4 0.25	231.0 9.09	1.5 0.06	317.0 12.48	25.40 1.00	8.73 0.34	1017.2	140.1	0.1433	49.59 109.32
H247535	H247510CD	6.4 0.25	241.0 9.49	1.5 0.06	362.1 14.26	28.58 1.13	11.91 0.47	1964.4	148.4	0.1638	123.87 273.09
H247536	H247510CD	6.4 0.25	241.0 9.49	1.5 0.06	362.1 14.26	28.58 1.13	11.91 0.47	2077.6	156.6	0.1671	127.26 280.53
67983	67920CD	3.5 0.14	222.0 8.74	0.8 0.03	275.0 10.83	19.05 0.75	7.13 0.28	819.5	172.0	0.1388	18.43 40.63
M541349	M541310CD	3.5 0.14	221.0 8.70	0.8 0.03	281.0 11.06	19.05 0.75	7.95 0.31	751.6	147.3	0.1253	21.67 47.78
M241547	M241510CD	3.5 0.14	221.0 8.70	1.5 0.06	279.0 10.98	19.05 0.75	8.73 0.34	954.1	127.9	0.1279	25.17 55.48
M241547H	M241510CD	3.5 0.14	221.0 8.70	1.5 0.06	279.0 10.98	19.05 0.75	8.73 0.34	954.1	127.9	0.1279	25.17 55.48

<sup>(4)</sup>These maximum fillet radii will be cleared by bearing corners.  
NOTE: For spacer configuration information, contact your Timken engineer.

# TAPERED ROLLER BEARINGS

## DOUBLE-ROW • TYPE TDO

### TYPE TDO



Bearing Dimensions				Load Ratings							
Bore d	O.D. D	Width T	Double Outer Ring Width C	Dynamic <sup>(1)</sup>		Factors <sup>(2)</sup>		Dynamic <sup>(3)</sup>			Factors <sup>(2)</sup>
				C <sub>1(2)</sub>	e	Y <sub>1</sub>	Y <sub>2</sub>	C <sub>90</sub>	C <sub>a90</sub>	C <sub>90(2)</sub>	K
mm in.	mm in.	mm in.	mm in.	N lbf				N lbf	N lbf	N lbf	
203.200 8.0000	317.500 12.5000	146.050 5.7500	111.125 4.3750	1270000 286000	0.52	1.29	1.92	190000 42600	170000 38200	330000 74200	1.12
203.200 8.0000	317.500 12.5000	146.050 5.7500	111.125 4.3750	1570000 352000	0.52	1.29	1.92	233000 52500	209000 47000	406000 91300	1.12
203.200 8.0000	368.300 14.5000	193.675 7.6250	136.525 5.3750	2030000 457000	0.40	1.68	2.50	303000 68100	208000 46800	527000 118000	1.45
203.238 8.0015	406.400 16.0000	196.850 7.7500	127.000 5.0000	2120000 477000	0.80	0.85	1.26	316000 71000	431000 97000	550000 124000	0.73
204.788 8.0625	292.100 11.5000	125.415 4.9376	101.600 4.0000	1040000 235000	0.33	2.03	3.02	156000 35000	88500 19900	271000 60900	1.76
206.375 8.1250	282.575 11.1250	101.600 4.0000	82.550 3.2500	875000 197000	0.51	1.33	1.97	130000 29300	114000 25500	227000 51000	1.15
206.375 8.1250	317.500 12.5000	127.000 5.0000	88.900 3.5000	919000 207000	0.31	2.15	3.21	137000 30800	73400 16500	238000 53600	1.86
206.375 8.1250	336.550 13.2500	211.137 8.3125	169.862 6.6875	2360000 530000	0.33	2.03	3.02	351000 79000	200000 45000	612000 137000	1.76
209.550 8.2500	282.575 11.1250	101.600 4.0000	82.550 3.2500	875000 197000	0.51	1.33	1.97	130000 29300	114000 25500	227000 51000	1.15
209.550 8.2500	317.500 12.5000	146.050 5.7500	111.125 4.3750	1270000 286000	0.52	1.29	1.92	190000 42600	170000 38200	330000 74200	1.12
209.550 8.2500	317.500 12.5000	146.050 5.7500	111.125 4.3750	1270000 286000	0.52	1.29	1.92	190000 42600	170000 38200	330000 74200	1.12
209.550 8.2500	319.976 12.5975	146.050 5.7500	111.215 4.3750	1270000 286000	0.52	1.29	1.92	190000 42600	170000 38200	330000 74200	1.12
209.550 8.2500	333.375 13.1250	149.225 5.8750	114.300 4.5000	1600000 359000	0.44	1.54	2.29	238000 53400	179000 40200	414000 93000	1.33
209.550 8.2500	355.600 14.0000	152.400 6.0000	111.125 4.3750	1320000 297000	0.59	1.14	1.70	197000 44200	199000 44700	343000 77000	0.99
212.725 8.3750	285.750 11.2500	98.425 3.8750	76.200 3.0000	748000 168000	0.48	1.40	2.09	111000 25000	91800 20600	194000 43600	1.21
215.900 8.5000	285.750 11.2500	98.425 3.8750	76.200 3.0000	659000 148000	0.48	1.40	2.09	98100 22100	80800 18200	171000 38400	1.21
215.900 8.5000	285.750 11.2500	98.425 3.8750	76.200 3.0000	748000 168000	0.48	1.40	2.09	111000 25000	91800 20600	194000 43600	1.21

<sup>(1)</sup>Based on 1 x 10<sup>6</sup> revolutions L<sub>10</sub> life, for the ISO life-calculation method. C<sub>1(2)</sub> is the double-row radial value.

<sup>(2)</sup>Consult your Timken engineer for instructions on use or review the Timken Engineering Manual on [timken.com/catalogs](http://timken.com/catalogs).

<sup>(3)</sup>Based on 90 x 10<sup>6</sup> revolutions L<sub>10</sub> life, for The Timken Company life-calculation method. C<sub>90</sub> and C<sub>a90</sub> are radial and thrust values for a single row. C<sub>90(2)</sub> is the double-row radial value.

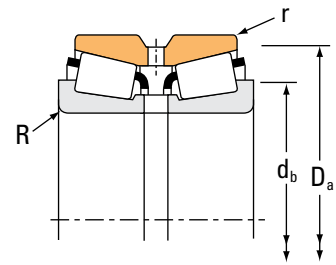
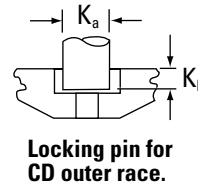
Part Number		Dimensions						Geometry Factors			Bearing Weight
Inner	Outer	Shaft		Housing		Pin		G <sub>1</sub>	G <sub>2</sub>	C <sub>g</sub>	
		Max. Shaft Fillet Radius R <sup>(4)</sup>	Backing Shoulder Dia. d <sub>b</sub>	Max. Housing Fillet Radius r <sup>(4)</sup>	Backing Shoulder Dia. D <sub>a</sub>	K <sub>a</sub>	K <sub>b</sub>				
		mm in.	mm in.	mm in.	mm in.	mm in.	mm in.				kg lbs.
93800	93127CD	4.3 0.17	227.0 8.94	1.5 0.06	298.5 11.75	22.23 0.88	10.31 0.41	912.5	126.1	0.1460	39.15 86.33
DX641856	DX979640	4.3 0.17	227.0 8.94	1.5 0.06	298.5 11.75	22.23 0.88	10.31 0.41	912.5	126.1	0.1460	39.15 86.33
EE420801	421451CD	3.3 0.13	230.1 9.06	1.5 0.06	334.4 13.16	25.40 1.00	11.91 0.47	1150.5	128.2	0.1450	78.57 173.20
EE114081	114161D	6.4 0.25	246.0 9.69	3.3 0.13	373.7 14.71	– –	– –	794.7	80.2	0.1571	101.81 224.48
M241549	M241510CD	3.5 0.14	223.0 8.78	1.5 0.06	279.0 10.98	19.05 0.75	8.73 0.34	954.1	127.9	0.1279	24.66 54.35
67985	67920CD	3.5 0.14	224.0 8.82	0.8 0.03	275.0 10.83	19.05 0.75	7.13 0.28	819.5	172.0	0.1388	17.63 38.87
EE132084	132126D	4.0 0.16	227.1 8.94	1.5 0.06	293.1 11.54	– –	– –	797.8	124.6	0.1174	33.32 73.45
H242649	H242610CD	3.3 0.13	231.0 9.09	1.5 0.06	318.0 12.51	28.58 1.13	10.34 0.41	1404.1	134.8	0.1465	68.60 151.22
67989	67920CD	3.5 0.14	227.0 8.94	0.8 0.03	275.0 10.83	19.05 0.75	7.13 0.28	819.5	172.0	0.1388	16.98 37.43
93825	93127CD	4.3 0.17	233.0 9.17	1.5 0.06	298.5 11.75	22.23 0.88	10.31 0.41	912.5	126.1	0.1460	37.02 81.62
93825A	93127CD	12.7 0.50	250.0 9.84	1.5 0.06	298.5 11.75	22.23 0.88	10.31 0.41	912.5	126.1	0.1460	36.70 80.90
93825	93128XD	4.3 0.17	233.0 9.17	1.5 0.06	300.0 11.81	– –	– –	912.5	126.1	0.1460	37.23 82.08
HM743345	HM743310CD	6.4 0.25	238.0 9.37	1.5 0.06	317.0 12.48	25.40 1.00	8.73 0.34	1017.2	140.1	0.1433	46.00 101.41
96825	96140CD	7.0 0.28	246.0 9.69	1.5 0.06	334.0 13.15	25.40 1.00	9.52 0.38	1140.0	160.6	0.1626	57.24 126.20
LM742745	LM742710CD	3.5 0.14	230.0 9.06	0.8 0.03	279.0 10.98	17.45 0.69	7.13 0.28	866.9	225.2	0.1388	16.58 36.55
LM742748	LM742710CD	3.5 0.14	233.0 9.17	0.8 0.03	279.0 10.98	17.45 0.69	7.13 0.28	808.2	210.6	0.1354	15.54 34.25
LM742749	LM742710CD	3.5 0.14	233.0 9.17	0.8 0.03	279.0 10.98	17.45 0.69	7.13 0.28	866.9	225.2	0.1388	15.78 34.78

<sup>(4)</sup>These maximum fillet radii will be cleared by bearing corners.  
NOTE: For spacer configuration information, contact your Timken engineer.

# TAPERED ROLLER BEARINGS

## DOUBLE-ROW • TYPE TDO

### TYPE TDO



Bearing Dimensions				Load Ratings							
Bore d	O.D. D	Width T	Double Outer Ring Width C	Dynamic <sup>(1)</sup>				Dynamic <sup>(3)</sup>			
				C <sub>1(2)</sub>	e	Y <sub>1</sub>	Y <sub>2</sub>	C <sub>90</sub>	C <sub>a90</sub>	C <sub>90(2)</sub>	K
mm in.	mm in.	mm in.	mm in.	N lbf				N lbf	N lbf	N lbf	
215.900 8.5000	287.338 11.3125	69.850 2.7500	50.800 2.0000	416000 93600	0.39	1.75	2.61	62000 13900	40900 9190	108000 24300	1.52
215.900 8.5000	355.600 14.0000	152.400 6.0000	111.125 4.3750	1390000 312000	0.33	2.04	3.04	206000 46400	117000 26200	359000 80800	1.77
215.900 8.5000	355.600 14.0000	158.750 6.2500	117.475 4.6250	1390000 312000	0.33	2.04	3.04	206000 46400	117000 26200	359000 80800	1.77
215.900 8.5000	371.475 14.6250	174.625 6.8750	136.525 5.3750	1920000 432000	0.40	1.68	2.50	286000 64300	197000 44200	498000 112000	1.45
215.900 8.5000	406.400 16.0000	195.262 7.6875	147.638 5.8125	2560000 577000	0.39	1.72	2.55	382000 85900	257000 57800	665000 149000	1.48
219.969 8.6602	287.338 11.3125	69.850 2.7500	50.800 2.0000	416000 93600	0.39	1.75	2.61	62000 13900	40900 9190	108000 24300	1.52
220.000 8.6614	340.000 13.3858	164.000 6.4567	130.000 5.1181	1730000 389000	0.43	1.57	2.34	258000 57900	190000 42700	449000 101000	1.36
220.662 8.6875	314.325 12.3750	131.762 5.1875	106.362 4.1875	1490000 335000	0.33	2.03	3.02	222000 49900	126000 28400	386000 86800	1.76
220.662 8.6875	314.325 12.3750	131.762 5.1875	106.362 4.1875	1210000 272000	0.33	2.03	3.02	180000 40500	103000 23100	314000 70500	1.76
220.662 8.6875	314.325 12.3750	131.762 5.1875	106.362 4.1875	1390000 312000	0.33	2.03	3.02	207000 46500	118000 26500	360000 80900	1.76
225.425 8.8750	355.600 14.0000	152.600 6.0000	152.600 6.0000	1390000 312000	0.33	2.04	3.04	206000 46400	117000 26200	359000 80800	1.77
225.425 8.8750	355.600 14.0000	158.750 6.2500	158.750 6.2500	1390000 312000	0.33	2.04	3.04	206000 46400	117000 26200	359000 80800	1.77
225.425 8.8750	400.050 15.7500	187.325 7.3750	136.525 5.3750	1960000 440000	0.44	1.54	2.29	291000 65500	219000 49300	507000 114000	1.33
228.397 8.9920	431.800 17.0000	196.850 7.7500	111.125 4.3750	2220000 499000	0.88	0.76	1.14	330000 74300	500000 112000	575000 129000	0.66
228.460 8.9945	431.800 17.0000	196.850 7.7500	111.125 4.3750	2220000 499000	0.88	0.76	1.14	330000 74300	500000 112000	575000 129000	0.66
228.600 9.0000	327.025 12.8750	114.300 4.5000	82.550 3.2500	972000 219000	0.41	1.66	2.47	145000 32500	101000 22700	252000 56700	1.44
228.600 9.0000	355.600 14.0000	152.400 6.0000	111.125 4.3750	1320000 297000	0.59	1.14	1.70	197000 44200	199000 44700	343000 77000	0.99

<sup>(1)</sup>Based on 1 x 10<sup>6</sup> revolutions L<sub>10</sub> life, for the ISO life-calculation method. C<sub>1(2)</sub> is the double-row radial value.

<sup>(2)</sup>Consult your Timken engineer for instructions on use or review the Timken Engineering Manual on [timken.com/catalogs](http://timken.com/catalogs).

<sup>(3)</sup>Based on 90 x 10<sup>6</sup> revolutions L<sub>10</sub> life, for The Timken Company life-calculation method. C<sub>90</sub> and C<sub>a90</sub> are radial and thrust values for a single row. C<sub>90(2)</sub> is the double-row radial value.

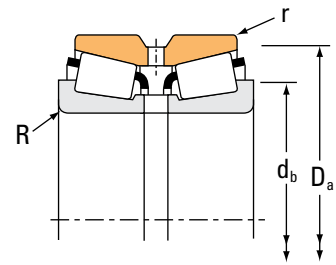
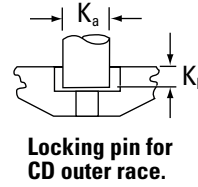
Part Number		Dimensions						Geometry Factors			Bearing Weight
Inner	Outer	Shaft		Housing		Pin		G <sub>1</sub>	G <sub>2</sub>	C <sub>G</sub>	
		Max. Shaft Fillet Radius R <sup>(4)</sup>	Backing Shoulder Dia. d <sub>b</sub>	Max. Housing Fillet Radius r <sup>(4)</sup>	Backing Shoulder Dia. D <sub>a</sub>	K <sub>a</sub>	K <sub>b</sub>				
		mm in.	mm in.	mm in.	mm in.	mm in.	mm in.				kg lbs.
543085	543115D	3.5 0.14	232.0 9.13	0.8 0.03	276.0 10.87	– –	– –	608.5	232.3	0.1135	11.47 25.30
EE130851	131401CD	6.8 0.27	248.0 9.76	1.5 0.06	330.0 12.99	22.23 0.88	8.73 0.34	1162.0	167.6	0.1358	53.77 118.52
EE130851	131402D	6.8 0.27	248.0 9.76	0.8 0.03	331.8 13.06	– –	– –	1162.0	167.6	0.1358	53.62 118.19
EE420850	421462XD	1.5 0.06	236.0 9.29	1.5 0.06	334.4 13.16	– –	– –	1150.5	128.2	0.1450	71.26 157.10
EE820085	820161CD	6.4 0.25	251.0 9.88	1.5 0.06	372.1 14.65	28.58 1.13	11.91 0.47	1326.8	111.9	0.1509	106.33 234.46
543086	543115D	3.5 0.14	235.0 9.25	0.8 0.03	276.0 10.87	– –	– –	608.5	232.3	0.1135	10.71 23.61
X32044XM	NP099132	4.0 0.16	248.0 9.76	1.0 0.04	326.5 12.85	– –	– –	1207.8	127.4	0.1509	50.74 111.88
DX596094	DX198514	6.4 0.25	245.0 9.65	1.5 0.06	300.0 11.81	22.23 0.88	9.52 0.38	1149.7	141.4	0.1360	31.26 68.92
M244249	M244210CD	6.4 0.25	245.0 9.65	1.5 0.06	300.0 11.81	22.23 0.88	9.52 0.38	1149.7	141.4	0.1360	29.97 66.07
NP995051	M244210CD	6.4 0.25	245.0 9.65	1.5 0.06	300.0 11.81	22.23 0.88	9.52 0.38	1149.7	141.4	0.1360	30.09 66.30
EE130889	131401CD	6.8 0.27	255.0 10.04	1.5 0.06	330.0 12.99	22.23 0.88	8.73 0.34	1162.0	167.6	0.1358	48.69 107.38
EE130889	131402D	6.8 0.27	255.0 10.04	0.8 0.03	331.8 13.06	– –	– –	1162.0	167.6	0.1358	48.90 107.83
EE430888	431576CD	1.5 0.06	251.0 9.88	1.5 0.06	364.2 14.34	28.58 1.13	11.91 0.47	1351.2	142.8	0.1572	90.91 200.41
EE113089	113171D	6.4 0.25	274.0 10.79	3.3 0.13	397.2 15.64	– –	– –	966.7	98.1	0.1723	109.66 241.73
EE113091	113171D	6.4 0.25	274.0 10.79	3.3 0.13	397.2 15.64	– –	– –	966.7	98.1	0.1723	107.78 237.60
8573	8520CD	6.4 0.25	255.0 10.04	1.5 0.06	312.0 12.28	19.05 0.75	7.92 0.31	1050.5	172.4	0.1401	28.22 62.23
96900	96140CD	7.0 0.28	260.0 10.24	1.5 0.06	334.0 13.15	25.40 1.00	9.52 0.38	1140.0	160.6	0.1626	49.73 109.66

<sup>(4)</sup>These maximum fillet radii will be cleared by bearing corners.  
NOTE: For spacer configuration information, contact your Timken engineer.

# TAPERED ROLLER BEARINGS

## DOUBLE-ROW • TYPE TDO

### TYPE TDO



Bearing Dimensions				Load Ratings							
Bore d	O.D. D	Width T	Double Outer Ring Width C	Dynamic <sup>(1)</sup>				Dynamic <sup>(3)</sup>			
				C <sub>1(2)</sub>	e	Y <sub>1</sub>	Y <sub>2</sub>	C <sub>90</sub>	C <sub>a90</sub>	C <sub>90(2)</sub>	K
mm in.	mm in.	mm in.	mm in.	N lbf				N lbf	N lbf	N lbf	
228.600 9.0000	355.600 14.0000	152.400 6.0000	111.125 4.3750	1470000 330000	0.33	2.04	3.04	219000 49100	124000 27800	381000 85600	1.77
228.600 9.0000	355.600 14.0000	152.400 6.0000	114.300 4.5000	1660000 372000	0.47	1.43	2.12	247000 55400	200000 44900	429000 96500	1.24
228.600 9.0000	355.600 14.0000	158.750 6.2500	117.475 4.6250	1470000 330000	0.33	2.04	3.04	219000 49100	124000 27800	381000 85600	1.77
228.600 9.0000	358.775 14.1250	152.400 6.0000	117.475 4.6250	1590000 358000	0.33	2.03	3.02	237000 53300	135000 30300	413000 92800	1.76
228.600 9.0000	400.050 15.7500	187.325 7.3750	136.525 5.3750	1960000 440000	0.44	1.54	2.29	291000 65500	219000 49300	507000 114000	1.33
228.600 9.0000	425.450 16.7500	209.550 8.2500	158.750 6.2500	2960000 665000	0.33	2.03	3.02	440000 99000	251000 56400	767000 172000	1.76
228.600 9.0000	488.950 19.2500	254.000 10.0000	152.400 6.0000	3910000 879000	0.94	0.72	1.07	582000 131000	934000 210000	1010000 228000	0.62
231.775 9.1250	358.775 14.1250	152.400 6.0000	117.475 4.6250	1590000 358000	0.33	2.03	3.02	237000 53300	135000 30300	413000 92800	1.76
234.950 9.2500	311.150 12.2500	98.425 3.8750	73.025 2.8750	768000 173000	0.36	1.86	2.77	114000 25700	70900 15900	199000 44800	1.61
234.950 9.2500	327.025 12.8750	114.300 4.5000	82.550 3.2500	935000 210000	0.41	1.66	2.47	139000 31300	96900 21800	242000 54500	1.44
234.950 9.2500	355.600 14.0000	152.400 6.0000	111.125 4.3750	1320000 297000	0.59	1.14	1.70	197000 44200	199000 44700	343000 77000	0.99
234.950 9.2500	384.175 15.1250	238.125 9.3750	193.675 7.6250	3270000 734000	0.33	2.03	3.02	486000 109000	277000 62200	847000 190000	1.76
234.950 9.2500	384.175 15.1250	238.125 9.3750	193.675 7.6250	2920000 656000	0.33	2.03	3.02	434000 97600	247000 55600	756000 170000	1.76
237.330 9.3437	358.775 14.1250	152.400 6.0000	117.475 4.6250	1590000 358000	0.33	2.03	3.02	237000 53300	135000 30300	413000 92800	1.76
241.300 9.5000	327.025 12.8750	114.300 4.5000	82.550 3.2500	918000 206000	0.41	1.66	2.47	137000 30700	95200 21400	238000 53500	1.44
241.300 9.5000	349.148 13.7460	127.000 5.0000	101.600 4.0000	1150000 258000	0.35	1.91	2.85	171000 38500	103000 23300	298000 67000	1.65
241.300 9.5000	350.838 13.8125	127.000 5.0000	101.600 4.0000	1150000 258000	0.35	1.91	2.85	171000 38500	103000 23300	298000 67000	1.65

<sup>(1)</sup>Based on  $1 \times 10^6$  revolutions  $L_{10}$  life, for the ISO life-calculation method.  $C_{1(2)}$  is the double-row radial value.

<sup>(2)</sup>Consult your Timken engineer for instructions on use or review the Timken Engineering Manual on [timken.com/catalogs](http://timken.com/catalogs).

<sup>(3)</sup>Based on  $90 \times 10^6$  revolutions  $L_{10}$  life, for The Timken Company life-calculation method.  $C_{90}$  and  $C_{a90}$  are radial and thrust values for a single row.  $C_{90(2)}$  is the double-row radial value.



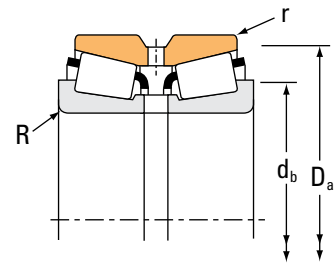
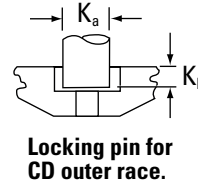
Part Number		Dimensions						Geometry Factors			Bearing Weight
Inner	Outer	Shaft		Housing		Pin		G <sub>1</sub>	G <sub>2</sub>	C <sub>g</sub>	
		Max. Shaft Fillet Radius R <sup>(4)</sup>	Backing Shoulder Dia. d <sub>b</sub>	Max. Housing Fillet Radius r <sup>(4)</sup>	Backing Shoulder Dia. D <sub>a</sub>	K <sub>a</sub>	K <sub>b</sub>				
		mm in.	mm in.	mm in.	mm in.	mm in.	mm in.				kg lbs.
EE130902	131401CD	6.8 0.27	257.0 10.12	1.5 0.06	330.0 12.99	22.23 0.88	8.73 0.34	1162.0	167.6	0.1358	48.41 106.71
HM746646	HM746610CD	6.4 0.25	258.0 10.16	1.5 0.06	338.7 13.34	25.40 1.00	9.52 0.38	1185.7	149.4	0.1542	55.11 121.49
EE130902	131402D	6.8 0.27	257.0 10.12	0.8 0.03	331.8 13.06	– –	– –	1162.0	167.6	0.1358	48.76 107.48
M249732	M249710CD	3.5 0.14	256.0 10.08	1.5 0.06	343.0 13.50	25.40 1.00	8.73 0.34	1626.0	173.0	0.1526	56.43 124.42
EE430900	431576CD	10.5 0.41	271.0 10.67	1.5 0.06	364.2 14.34	28.58 1.13	11.91 0.47	1351.2	142.8	0.1572	88.47 195.04
EE700091	700168D	7.0 0.28	266.0 10.47	1.5 0.06	384.3 15.13	– –	– –	1488.7	109.7	0.1480	115.99 255.71
HH949549	HH949510D	6.4 0.25	297.0 11.69	1.5 0.06	456.0 17.95	– –	– –	1295.5	91.5	0.1931	204.99 451.94
M249734	M249710CD	6.4 0.25	263.0 10.35	1.5 0.06	343.0 13.50	25.40 1.00	8.73 0.34	1626.0	173.0	0.1526	54.98 121.22
LM446349	LM446310D	3.5 0.14	252.0 9.92	0.8 0.03	301.0 11.85	17.46 0.69	6.91 0.27	1008.4	243.6	0.1328	18.04 39.75
8574	8520CD	6.4 0.25	259.0 10.20	1.5 0.06	312.0 12.28	19.05 0.75	7.92 0.31	1010.5	166.1	0.1382	26.16 57.67
96925	96140CD	7.0 0.28	265.0 10.43	1.5 0.06	334.0 13.15	25.40 1.00	9.52 0.38	1140.0	160.6	0.1626	46.94 103.50
H247548	H247510CD	6.4 0.25	269.0 10.59	1.5 0.06	362.1 14.26	28.58 1.13	11.91 0.47	2077.6	156.6	0.1671	105.89 233.45
H247549	H247510CD	6.4 0.25	273.0 10.75	1.5 0.06	362.1 14.26	28.58 1.13	11.91 0.47	1964.4	148.4	0.1638	102.68 226.40
M249736	M249710CD	6.4 0.25	267.0 10.51	1.5 0.06	343.0 13.50	25.40 1.00	8.73 0.34	1626.0	173.0	0.1526	51.88 114.37
8578	8520CD	6.4 0.25	264.0 10.39	1.5 0.06	312.0 12.28	19.05 0.75	7.92 0.31	1050.5	172.4	0.1401	23.96 52.86
EE127095	127136CD	6.4 0.25	267.0 10.51	1.5 0.06	329.0 12.95	22.23 0.88	9.52 0.38	1178.6	164.4	0.1392	35.35 77.93
EE127095	127137D	6.4 0.25	267.0 10.51	1.5 0.06	329.0 12.95	– –	– –	1178.6	164.4	0.1392	36.87 81.29

<sup>(4)</sup>These maximum fillet radii will be cleared by bearing corners.  
NOTE: For spacer configuration information, contact your Timken engineer.

# TAPERED ROLLER BEARINGS

## DOUBLE-ROW • TYPE TDO

### TYPE TDO



Bearing Dimensions				Load Ratings							
Bore d	O.D. D	Width T	Double Outer Ring Width C	Dynamic <sup>(1)</sup>				Dynamic <sup>(3)</sup>			
				C <sub>1(2)</sub>	e	Y <sub>1</sub>	Y <sub>2</sub>	C <sub>90</sub>	C <sub>a90</sub>	C <sub>90(2)</sub>	K
mm in.	mm in.	mm in.	mm in.	N lbf				N lbf	N lbf	N lbf	
241.300 9.5000	355.498 13.9960	127.000 5.0000	101.600 4.0000	1150000 258000	0.35	1.91	2.85	171000 38500	103000 23300	298000 67000	1.65
241.300 9.5000	368.300 14.5000	120.650 4.7500	85.725 3.3750	1120000 252000	0.36	1.86	2.77	167000 37500	104000 23300	290000 65200	1.61
241.300 9.5000	393.700 15.5000	157.162 6.1875	109.538 4.3125	1760000 396000	0.40	1.68	2.50	262000 59000	181000 40600	457000 103000	1.45
241.300 9.5000	406.400 16.0000	155.575 6.1250	107.950 4.2500	1760000 396000	0.40	1.68	2.50	262000 59000	181000 40600	457000 103000	1.45
241.300 9.5000	406.400 16.0000	215.900 8.5000	184.150 7.2500	3260000 732000	0.33	2.03	3.02	485000 109000	276000 62000	844000 190000	1.76
241.300 9.5000	444.500 17.5000	209.550 8.2500	158.750 6.2500	3170000 713000	0.34	2.00	2.98	472000 106000	273000 61300	822000 185000	1.73
241.300 9.5000	488.950 19.2500	254.000 10.0000	196.850 7.7500	4220000 948000	0.31	2.16	3.21	628000 141000	336000 75600	1090000 246000	1.87
244.475 9.6250	380.898 14.9960	171.450 6.7500	127.000 5.0000	1580000 355000	0.52	1.31	1.95	235000 52900	208000 46800	410000 92100	1.13
244.475 9.6250	381.000 15.0000	171.450 6.7500	127.000 5.0000	1580000 355000	0.52	1.31	1.95	235000 52900	208000 46800	410000 92100	1.13
247.650 9.7500	368.300 14.5000	120.650 4.7500	85.725 3.3750	1120000 252000	0.36	1.86	2.77	167000 37500	104000 23300	290000 65200	1.61
247.650 9.7500	381.000 15.0000	158.750 6.2500	123.825 4.8750	2000000 450000	0.33	2.03	3.02	298000 67000	170000 38100	519000 117000	1.76
247.650 9.7500	406.400 16.0000	247.650 9.7500	203.200 8.0000	3620000 814000	0.33	2.03	3.02	539000 121000	307000 69000	939000 211000	1.76
247.650 9.7500	406.400 16.0000	247.650 9.7500	206.200 8.1181	3830000 860000	0.33	2.03	3.02	570000 128000	324000 72900	992000 223000	1.76
249.250 9.8130	380.898 14.9960	171.450 6.7500	127.000 5.0000	1580000 355000	0.52	1.31	1.95	235000 52900	208000 46800	410000 92100	1.13
249.250 9.8130	381.000 15.0000	171.450 6.7500	127.000 5.0000	1580000 355000	0.52	1.31	1.95	235000 52900	208000 46800	410000 92100	1.13
254.000 10.0000	323.850 12.7500	63.500 2.5000	50.800 2.0000	263000 59100	0.35	1.95	2.90	39200 8800	23200 5220	68200 15300	1.69
254.000 10.0000	347.662 13.6875	95.250 3.7500	69.850 2.7500	1070000 240000	0.33	2.03	3.02	159000 35700	90500 20300	277000 62200	1.76

<sup>(1)</sup>Based on  $1 \times 10^6$  revolutions  $L_{10}$  life, for the ISO life-calculation method.  $C_{1(2)}$  is the double-row radial value.

<sup>(2)</sup>Consult your Timken engineer for instructions on use or review the Timken Engineering Manual on [timken.com/catalogs](http://timken.com/catalogs).

<sup>(3)</sup>Based on  $90 \times 10^6$  revolutions  $L_{10}$  life, for The Timken Company life-calculation method.  $C_{90}$  and  $C_{a90}$  are radial and thrust values for a single row.  $C_{90(2)}$  is the double-row radial value.

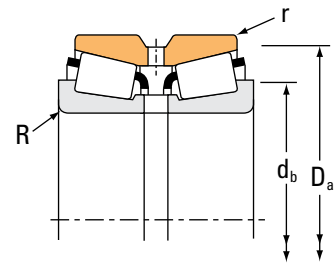
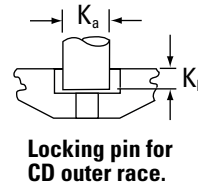
Part Number		Dimensions						Geometry Factors			Bearing Weight
Inner	Outer	Shaft		Housing		Pin		G <sub>1</sub>	G <sub>2</sub>	C <sub>G</sub>	
		Max. Shaft Fillet Radius R <sup>(4)</sup>	Backing Shoulder Dia. d <sub>b</sub>	Max. Housing Fillet Radius r <sup>(4)</sup>	Backing Shoulder Dia. D <sub>a</sub>	K <sub>a</sub>	K <sub>b</sub>				
		mm in.	mm in.	mm in.	mm in.	mm in.	mm in.				kg lbs.
EE127095	127139D	6.4 0.25	267.0 10.51	1.5 0.06	329.0 12.95	– –	– –	1178.6	164.4	0.1392	38.19 84.19
EE170950	171451CD	6.4 0.25	269.0 10.59	1.5 0.06	337.0 13.27	19.05 0.75	10.34 0.41	1068.6	171.6	0.1354	40.00 88.17
EE275095	275156D	6.4 0.25	278.0 10.94	1.5 0.06	378.1 14.89	– –	– –	1451.8	201.3	0.1555	66.21 145.97
EE275095	275161D	6.4 0.25	278.0 10.94	1.5 0.06	378.1 14.89	– –	– –	1451.8	201.3	0.1555	71.84 158.39
H249148	H249111CD	6.4 0.25	273.0 10.75	1.5 0.06	385.0 15.16	28.58 1.13	11.91 0.47	1709.2	135.5	0.1556	104.28 229.92
EE923095	923176D	6.4 0.25	277.0 10.91	1.5 0.06	407.0 16.02	– –	– –	1626.7	136.5	0.1531	131.76 290.50
EE295950	295192D	6.4 0.25	285.0 11.22	1.5 0.06	450.5 17.74	– –	– –	2247.3	171.9	0.1664	214.36 472.59
EE126097	126149D	6.4 0.25	275.0 10.83	1.5 0.06	358.0 14.09	– –	– –	1321.8	168.9	0.1640	63.84 140.74
EE126097	126151CD	6.4 0.25	275.0 10.83	1.5 0.06	358.0 14.09	28.58 1.13	11.91 0.47	1321.8	168.9	0.1640	65.16 143.63
EE170975	171451CD	6.4 0.25	274.0 10.79	1.5 0.06	337.0 13.27	19.05 0.75	10.34 0.41	1068.6	171.6	0.1354	37.51 82.73
M252337	M252310CD	6.4 0.25	280.0 11.02	1.5 0.06	364.0 14.32	28.58 1.13	10.31 0.41	1839.2	226.1	0.1588	62.37 137.51
HH249949	HH249910CD	6.4 0.25	284.0 11.18	1.5 0.06	383.0 15.08	28.58 1.13	11.91 0.47	2373.9	173.3	0.1746	125.39 276.44
NP985601	NP490062	6.4 0.25	287.0 11.30	1.5 0.06	383.5 15.10	28.58 1.13	11.91 0.47	2373.9	173.3	0.1730	123.87 273.18
EE126098	126149D	6.4 0.25	279.0 10.98	1.5 0.06	358.0 14.09	– –	– –	1321.8	168.9	0.1640	62.77 138.40
EE126098	126151CD	6.4 0.25	279.0 10.98	1.5 0.06	358.0 14.09	28.58 1.13	11.91 0.47	1321.8	168.9	0.1640	62.66 138.15
29875	29820D	1.5 0.06	267.0 10.51	0.8 0.03	312.0 12.28	– –	– –	906.8	658.2	0.1567	11.05 24.34
LM249748	LM249710CD	3.5 0.14	272.0 10.71	1.5 0.06	333.0 13.11	15.86 0.62	7.13 0.28	1003.8	166.1	0.1287	22.68 50.02

<sup>(4)</sup>These maximum fillet radii will be cleared by bearing corners.  
NOTE: For spacer configuration information, contact your Timken engineer.

# TAPERED ROLLER BEARINGS

## DOUBLE-ROW • TYPE TDO

### TYPE TDO



Bearing Dimensions				Load Ratings							
Bore d	O.D. D	Width T	Double Outer Ring Width C	Dynamic <sup>(1)</sup>		Factors <sup>(2)</sup>		Dynamic <sup>(3)</sup>			Factors <sup>(2)</sup>
				C <sub>1(2)</sub>	e	Y <sub>1</sub>	Y <sub>2</sub>	C <sub>90</sub>	C <sub>a90</sub>	C <sub>90(2)</sub>	K
mm in.	mm in.	mm in.	mm in.	N lbf				N lbf	N lbf	N lbf	
254.000 10.0000	358.775 14.1250	152.400 6.0000	117.475 4.6250	1590000 358000	0.33	2.03	3.02	237000 53300	135000 30300	413000 92800	1.76
254.000 10.0000	365.125 14.3750	130.175 5.1250	98.425 3.8750	1180000 266000	0.37	1.80	2.69	176000 39600	113000 25400	307000 68900	1.56
254.000 10.0000	393.700 15.5000	157.162 6.1875	109.538 4.3125	1760000 396000	0.40	1.68	2.50	262000 59000	181000 40600	457000 103000	1.45
254.000 10.0000	406.400 16.0000	155.575 6.1250	107.950 4.2500	1760000 396000	0.40	1.68	2.50	262000 59000	181000 40600	457000 103000	1.45
254.000 10.0000	422.275 16.6250	173.038 6.8125	128.588 5.0625	2610000 587000	0.33	2.03	3.02	389000 87400	221000 49700	677000 152000	1.76
254.000 10.0000	422.275 16.6250	173.038 6.8125	128.588 5.0625	2690000 605000	0.33	2.03	3.02	401000 90100	228000 51300	698000 157000	1.76
254.000 10.0000	422.275 16.6250	178.592 7.0312	139.700 5.5000	2610000 587000	0.33	2.03	3.02	389000 87400	221000 49700	677000 152000	1.76
254.000 10.0000	422.275 16.6250	178.592 7.0312	139.700 5.5000	2690000 605000	0.33	2.03	3.02	401000 90100	228000 51300	698000 157000	1.76
254.000 10.0000	431.724 16.9970	173.038 6.8125	128.588 5.0625	2610000 587000	0.33	2.03	3.02	389000 87400	221000 49700	677000 152000	1.76
254.000 10.0000	431.724 16.9970	173.038 6.8125	128.588 5.0625	2690000 605000	0.33	2.03	3.02	401000 90100	228000 51300	698000 157000	1.76
254.000 10.0000	444.500 17.5000	165.100 6.5000	114.300 4.5000	2050000 460000	0.34	1.98	2.95	305000 68500	178000 40000	531000 119000	1.71
254.000 10.0000	495.300 19.5000	162.245 6.3876	120.650 4.7500	2700000 607000	0.40	1.68	2.50	402000 90300	277000 62200	700000 157000	1.45
254.000 10.0000	495.300 19.5000	168.595 6.6376	127.000 5.0000	2700000 607000	0.40	1.68	2.50	402000 90300	277000 62200	700000 157000	1.45
254.000 10.0000	533.400 21.0000	276.225 10.8750	165.100 6.5000	4670000 1050000	0.94	0.72	1.07	696000 156000	1120000 251000	1210000 272000	0.62
260.350 10.2500	365.125 14.3750	130.175 5.1250	98.425 3.8750	1180000 266000	0.37	1.80	2.69	176000 39600	113000 25400	307000 68900	1.56
260.350 10.2500	400.050 15.7500	155.575 6.1250	107.950 4.2500	1650000 372000	0.39	1.71	2.55	246000 55300	166000 37400	429000 96300	1.48
260.350 10.2500	419.100 16.5000	184.150 7.2500	136.525 5.3750	1960000 440000	0.60	1.12	1.66	291000 65500	302000 67800	507000 114000	0.97

<sup>(1)</sup>Based on  $1 \times 10^6$  revolutions  $L_{10}$  life, for the ISO life-calculation method.  $C_{1(2)}$  is the double-row radial value.

<sup>(2)</sup>Consult your Timken engineer for instructions on use or review the Timken Engineering Manual on [timken.com/catalogs](http://timken.com/catalogs).

<sup>(3)</sup>Based on  $90 \times 10^6$  revolutions  $L_{10}$  life, for The Timken Company life-calculation method.  $C_{90}$  and  $C_{a90}$  are radial and thrust values for a single row.  $C_{90(2)}$  is the double-row radial value.

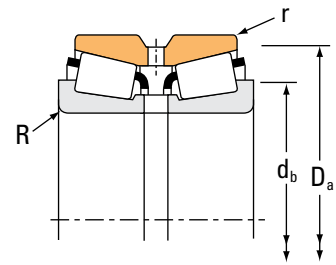
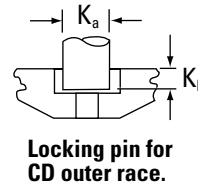
Part Number		Dimensions						Geometry Factors			Bearing Weight
Inner	Outer	Shaft		Housing		Pin		G <sub>1</sub>	G <sub>2</sub>	C <sub>G</sub>	
		Max. Shaft Fillet Radius R <sup>(4)</sup>	Backing Shoulder Dia. d <sub>b</sub>	Max. Housing Fillet Radius r <sup>(4)</sup>	Backing Shoulder Dia. D <sub>a</sub>	K <sub>a</sub>	K <sub>b</sub>				
		mm in.	mm in.	mm in.	mm in.	mm in.	mm in.				kg lbs.
M249749	M249710CD	3.5 0.14	274.0 10.79	1.5 0.06	343.0 13.50	25.40 1.00	8.73 0.34	1626.0	173.0	0.1526	44.79 98.76
EE134100	134144CD	6.4 0.25	281.0 11.06	1.5 0.06	347.0 13.66	22.23 0.88	10.34 0.41	1327.7	187.2	0.1474	39.21 86.45
EE275100	275156D	6.4 0.25	287.0 11.30	1.5 0.06	378.1 14.89	– –	– –	1451.8	201.3	0.1555	60.81 134.04
EE275100	275161D	6.4 0.25	287.0 11.30	1.5 0.06	378.1 14.89	– –	– –	1451.8	201.3	0.1555	66.44 146.46
HM252343	HM252311D	6.8 0.27	287.0 11.30	1.5 0.06	400.0 15.73	– –	– –	1504.3	147.8	0.1482	84.84 187.02
HM252344	HM252311D	6.8 0.27	287.0 11.30	1.5 0.06	400.0 15.73	– –	– –	1551.8	152.3	0.1498	89.43 197.15
HM252343	HM252310CD	6.8 0.27	287.0 11.30	1.5 0.06	400.0 15.73	28.58 1.13	11.91 0.47	1504.3	147.8	0.1482	86.16 189.93
HM252344	HM252310CD	6.8 0.27	287.0 11.30	1.5 0.06	400.0 15.73	28.58 1.13	11.91 0.47	1551.8	152.3	0.1498	90.75 200.06
HM252343	HM252315D	6.8 0.27	287.0 11.30	1.5 0.06	398.3 15.68	– –	– –	1504.3	147.8	0.1482	89.83 198.03
HM252344	HM252315D	6.8 0.27	287.0 11.30	1.5 0.06	398.3 15.68	– –	– –	1551.8	152.3	0.1498	94.42 208.16
EE822100	822176D	6.4 0.25	288.0 11.34	1.5 0.06	405.4 15.96	– –	– –	1363.4	186.1	0.1442	94.11 207.47
EE941002	941951XD	6.4 0.25	301.0 11.85	1.5 0.06	463.4 18.25	– –	– –	1771.6	187.4	0.1657	132.72 292.60
EE941002	941953D	6.4 0.25	301.0 11.85	1.5 0.06	463.4 18.25	– –	– –	1771.6	187.4	0.1657	133.71 294.78
HH953749	HH953710D	6.4 0.25	328.0 12.91	1.5 0.06	495.7 19.51	– –	– –	1668.7	104.2	0.2101	266.11 586.68
EE134102	134144CD	6.4 0.25	286.0 11.26	1.5 0.06	347.0 13.66	22.23 0.88	10.34 0.41	1327.7	187.2	0.1474	36.73 80.99
EE221026	221576CD	9.7 0.38	296.0 11.65	1.5 0.06	371.5 14.63	22.23 0.88	10.31 0.41	1320.8	207.5	0.1497	59.83 131.92
EE435102	435165CD	6.4 0.25	295.0 11.61	1.5 0.06	395.1 15.56	28.58 1.13	11.91 0.47	1480.2	123.2	0.1787	88.36 194.77

<sup>(4)</sup>These maximum fillet radii will be cleared by bearing corners.  
NOTE: For spacer configuration information, contact your Timken engineer.

# TAPERED ROLLER BEARINGS

## DOUBLE-ROW • TYPE TDO

### TYPE TDO



Bearing Dimensions				Load Ratings							
Bore d	O.D. D	Width T	Double Outer Ring Width C	Dynamic <sup>(1)</sup>		Factors <sup>(2)</sup>		Dynamic <sup>(3)</sup>			Factors <sup>(2)</sup>
				C <sub>1(2)</sub>	e	Y <sub>1</sub>	Y <sub>2</sub>	C <sub>90</sub>	C <sub>a90</sub>	C <sub>90(2)</sub>	K
mm in.	mm in.	mm in.	mm in.	N lbf				N lbf	N lbf	N lbf	
260.350 10.2500	419.100 16.5000	184.150 7.2500	136.525 5.3750	1960000 440000	0.60	1.12	1.66	291000 65500	302000 67800	507000 114000	0.97
260.350 10.2500	422.275 16.6250	173.038 6.8125	128.588 5.0625	2610000 587000	0.33	2.03	3.02	389000 87400	221000 49700	677000 152000	1.76
260.350 10.2500	422.275 16.6250	178.592 7.0312	139.700 5.5000	2610000 587000	0.33	2.03	3.02	389000 87400	221000 49700	677000 152000	1.76
260.350 10.2500	422.275 16.6250	178.592 7.0312	139.700 5.5000	2690000 605000	0.33	2.03	3.02	401000 90100	228000 51300	698000 157000	1.76
260.350 10.2500	422.910 16.6500	178.592 7.0312	139.700 5.5000	2610000 587000	0.33	2.03	3.02	389000 87400	221000 49700	677000 152000	1.76
260.350 10.2500	431.724 16.9970	173.038 6.8125	128.588 5.0625	2690000 605000	0.33	2.03	3.02	401000 90100	228000 51300	698000 157000	1.76
260.350 10.2500	488.950 19.2500	254.000 10.0000	196.850 7.7500	4220000 948000	0.31	2.16	3.21	628000 141000	336000 75600	1090000 246000	1.87
260.350 10.2500	488.950 19.2500	254.000 10.0000	196.850 7.7500	4220000 948000	0.31	2.16	3.21	628000 141000	336000 75600	1090000 246000	1.87
263.525 10.3750	355.600 14.0000	127.000 5.0000	101.600 4.0000	1400000 315000	0.36	1.87	2.79	209000 46900	129000 28900	363000 81600	1.62
266.700 10.5000	323.850 12.7500	63.500 2.5000	50.800 2.0000	263000 59100	0.35	1.95	2.90	39200 8800	23200 5220	68200 15300	1.69
266.700 10.5000	355.600 14.0000	127.000 5.0000	101.600 4.0000	1530000 345000	0.36	1.87	2.79	228000 51300	141000 31600	397000 89300	1.62
266.700 10.5000	393.700 15.5000	157.162 6.1875	109.538 4.3125	1760000 396000	0.40	1.68	2.50	262000 59000	181000 40600	457000 103000	1.45
266.700 10.5000	393.700 15.5000	157.162 6.1875	109.538 4.3125	1760000 396000	0.40	1.68	2.50	262000 59000	181000 40600	457000 103000	1.45
266.700 10.5000	406.400 16.0000	155.575 6.1250	107.950 4.2500	1760000 396000	0.40	1.68	2.50	262000 59000	181000 40600	457000 103000	1.45
269.875 10.6250	381.000 15.0000	158.750 6.2500	123.825 4.8750	2000000 450000	0.33	2.03	3.02	298000 67000	170000 38100	519000 117000	1.76
273.050 10.7500	393.700 15.5000	157.162 6.1875	109.538 4.3125	1760000 396000	0.40	1.68	2.50	262000 59000	181000 40600	457000 103000	1.45
273.050 10.7500	393.700 15.5000	157.162 6.1875	109.538 4.3125	1760000 396000	0.40	1.68	2.50	262000 59000	181000 40600	457000 103000	1.45

<sup>(1)</sup>Based on  $1 \times 10^6$  revolutions  $L_{10}$  life, for the ISO life-calculation method.  $C_{1(2)}$  is the double-row radial value.

<sup>(2)</sup>Consult your Timken engineer for instructions on use or review the Timken Engineering Manual on [timken.com/catalogs](http://timken.com/catalogs).

<sup>(3)</sup>Based on  $90 \times 10^6$  revolutions  $L_{10}$  life, for The Timken Company life-calculation method.  $C_{90}$  and  $C_{a90}$  are radial and thrust values for a single row.  $C_{90(2)}$  is the double-row radial value.

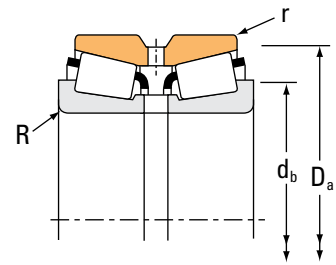
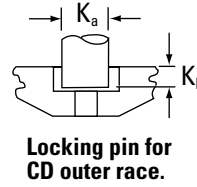
Part Number		Dimensions						Geometry Factors			Bearing Weight
Inner	Outer	Shaft		Housing		Pin		G <sub>1</sub>	G <sub>2</sub>	C <sub>G</sub>	
		Max. Shaft Fillet Radius R <sup>(4)</sup>	Backing Shoulder Dia. d <sub>b</sub>	Max. Housing Fillet Radius r <sup>(4)</sup>	Backing Shoulder Dia. D <sub>a</sub>	K <sub>a</sub>	K <sub>b</sub>				
		mm in.	mm in.	mm in.	mm in.	mm in.	mm in.				kg lbs.
EE435102	435165D	6.4 0.25	295.0 11.61	1.5 0.06	395.1 15.56	–	–	1480.2	123.2	0.1787	87.66 193.23
HM252348	HM252311D	6.8 0.27	292.0 11.50	1.5 0.06	400.0 15.73	–	–	1504.3	147.8	0.1482	81.96 180.67
HM252348	HM252310CD	6.8 0.27	292.0 11.50	1.5 0.06	400.0 15.73	28.58 1.13	11.91 0.47	1504.3	147.8	0.1482	82.85 182.64
HM252349	HM252310CD	6.8 0.27	292.0 11.50	1.5 0.06	400.0 15.73	28.58 1.13	11.91 0.47	1551.8	152.3	0.1498	87.21 192.26
HM252348	HM252312D	6.8 0.27	292.0 11.50	1.5 0.06	399.5 15.73	–	–	1504.3	147.8	0.1482	83.31 183.66
HM252349	HM252315D	6.8 0.27	292.0 11.50	1.5 0.06	398.3 15.68	–	–	1551.8	152.3	0.1498	92.67 204.30
EE295102	295192D	6.4 0.25	299.0 11.77	1.5 0.06	450.5 17.74	–	–	2247.3	171.9	0.1664	198.86 438.41
EE295102	295192CD	6.4 0.25	299.0 11.77	1.5 0.06	450.5 17.74	28.58 1.13	14.30 0.56	2247.3	171.9	0.1664	198.86 438.41
LM451345	LM451310CD	3.5 0.14	283.0 11.14	1.5 0.06	342.9 13.50	22.23 0.88	8.73 0.34	1554.1	212.2	0.1536	32.93 72.62
29880	29820D	1.5 0.06	277.0 10.91	0.8 0.03	312.0 12.28	–	–	906.8	658.2	0.1567	9.04 19.93
LM451349	LM451310CD	3.5 0.14	285.0 11.22	1.5 0.06	342.9 13.50	22.23 0.88	8.73 0.34	1554.1	212.2	0.1536	31.82 70.17
EE275105	275156CD	6.4 0.25	296.0 11.65	1.5 0.06	378.5 14.90	25.40 1.00	9.52 0.38	1451.8	201.3	0.1555	55.47 122.31
EE275105	275156D	6.4 0.25	296.0 11.65	1.5 0.06	378.1 14.89	–	–	1451.8	201.3	0.1555	55.11 121.50
EE275105	275161D	6.4 0.25	296.0 11.65	1.5 0.06	378.1 14.89	–	–	1451.8	201.3	0.1555	60.74 133.92
M252349	M252310CD	6.4 0.25	296.0 11.65	1.5 0.06	364.0 14.32	28.58 1.13	10.31 0.41	1839.2	226.1	0.1588	51.96 114.53
EE275108	275156CD	6.4 0.25	301.0 11.85	1.5 0.06	378.5 14.90	25.40 1.00	9.52 0.38	1451.8	201.3	0.1555	53.10 117.05
EE275108	275156D	6.4 0.25	301.0 11.85	1.5 0.06	378.1 14.89	–	–	1451.8	201.3	0.1555	52.35 115.39

<sup>(4)</sup>These maximum fillet radii will be cleared by bearing corners.  
NOTE: For spacer configuration information, contact your Timken engineer.

# TAPERED ROLLER BEARINGS

## DOUBLE-ROW • TYPE TDO

### TYPE TDO



Bearing Dimensions				Load Ratings							
Bore d	O.D. D	Width T	Double Outer Ring Width C	Dynamic <sup>(1)</sup>		Factors <sup>(2)</sup>		Dynamic <sup>(3)</sup>			Factors <sup>(2)</sup>
				C <sub>1(2)</sub>	e	Y <sub>1</sub>	Y <sub>2</sub>	C <sub>90</sub>	C <sub>a90</sub>	C <sub>90(2)</sub>	K
mm in.	mm in.	mm in.	mm in.	N lbf				N lbf	N lbf	N lbf	
273.050 10.7500	406.400 16.0000	155.575 6.1250	107.950 4.2500	1760000 396000	0.40	1.68	2.50	262000 59000	181000 40600	457000 103000	1.45
276.225 10.8750	508.000 20.0000	190.500 7.5000	127.000 5.0000	2510000 565000	0.58	1.17	1.75	374000 84100	369000 82900	651000 146000	1.01
279.400 11.0000	374.650 14.7500	104.775 4.1250	79.375 3.1250	905000 203000	0.40	1.68	2.50	135000 30300	92700 20800	235000 52700	1.45
279.400 11.0000	469.900 18.5000	200.025 7.8750	149.225 5.8750	2810000 631000	0.38	1.79	2.66	418000 94000	271000 60800	728000 164000	1.55
279.400 11.0000	488.950 19.2500	254.000 10.0000	196.850 7.7500	4220000 948000	0.31	2.16	3.21	628000 141000	336000 75600	1090000 246000	1.87
279.400 11.0000	488.950 19.2500	254.000 10.0000	196.850 7.7500	4220000 948000	0.31	2.16	3.21	628000 141000	336000 75600	1090000 246000	1.87
279.982 11.0229	380.898 14.9960	139.700 5.5000	107.950 4.2500	1260000 283000	0.43	1.56	2.33	187000 42100	138000 31100	326000 73300	1.35
280.192 11.0312	406.400 16.0000	120.650 4.7500	85.725 3.3750	1200000 270000	0.41	1.65	2.46	179000 40200	125000 28100	311000 70000	1.43
280.192 11.0312	406.400 16.0000	149.225 5.8750	117.475 4.6250	1610000 362000	0.39	1.75	2.60	240000 53900	158000 35600	417000 93800	1.51
285.750 11.2500	358.775 14.1250	76.200 3.0000	53.975 2.1250	449000 101000	0.49	1.37	2.04	66800 15000	56300 12600	116000 26200	1.19
285.750 11.2500	380.898 14.9960	139.700 5.5000	107.950 4.2500	1260000 283000	0.43	1.56	2.33	187000 42100	138000 31100	326000 73300	1.35
285.750 11.2500	469.900 18.5000	177.785 6.9994	127.000 5.0000	2630000 591000	0.29	2.31	3.44	391000 88000	196000 44000	681000 153000	2.00
285.750 11.2500	476.250 18.7500	177.785 6.9994	127.000 5.0000	2630000 591000	0.29	2.31	3.44	391000 88000	196000 44000	681000 153000	2.00
285.750 11.2500	501.650 19.7500	202.200 8.0000	120.650 4.7500	2370000 533000	0.83	0.81	1.20	353000 79400	505000 113000	615000 138000	0.70
288.925 11.3750	406.400 16.0000	165.100 6.5000	130.175 5.1250	2380000 534000	0.34	2.00	2.97	354000 79500	205000 46000	616000 138000	1.73
292.100 11.5000	469.900 18.5000	200.025 7.8750	149.225 5.8750	2810000 631000	0.38	1.79	2.66	418000 94000	271000 60800	728000 164000	1.55
292.100 11.5000	469.900 18.5000	200.025 7.8750	149.225 5.8750	3030000 681000	0.38	1.79	2.66	451000 101000	292000 65600	785000 176000	1.55

<sup>(1)</sup>Based on 1 x 10<sup>6</sup> revolutions L<sub>10</sub> life, for the ISO life-calculation method. C<sub>1(2)</sub> is the double-row radial value.

<sup>(2)</sup>Consult your Timken engineer for instructions on use or review the Timken Engineering Manual on [timken.com/catalogs](http://timken.com/catalogs).

<sup>(3)</sup>Based on 90 x 10<sup>6</sup> revolutions L<sub>10</sub> life, for The Timken Company life-calculation method. C<sub>90</sub> and C<sub>a90</sub> are radial and thrust values for a single row. C<sub>90(2)</sub> is the double-row radial value.



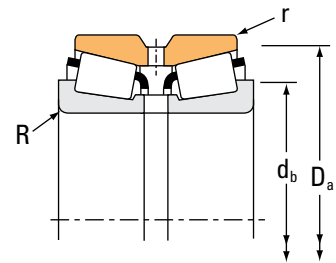
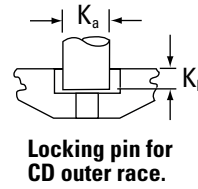
Part Number		Dimensions						Geometry Factors			Bearing Weight
Inner	Outer	Shaft		Housing		Pin		G <sub>1</sub>	G <sub>2</sub>	C <sub>G</sub>	
		Max. Shaft Fillet Radius R <sup>(4)</sup>	Backing Shoulder Dia. d <sub>b</sub>	Max. Housing Fillet Radius r <sup>(4)</sup>	Backing Shoulder Dia. D <sub>a</sub>	K <sub>a</sub>	K <sub>b</sub>				
		mm in.	mm in.	mm in.	mm in.	mm in.	mm in.				kg lbs.
EE275108	275161D	6.4 0.25	301.0 11.85	1.5 0.06	378.1 14.89	– –	– –	1451.8	201.3	0.1555	57.98 127.80
HM855449	HM855419D	6.4 0.25	313.0 12.32	3.3 0.13	430.0 16.93	– –	– –	1651.5	173.3	0.1824	152.70 336.65
L555233	L555210D	3.5 0.14	300.0 11.81	1.5 0.06	362.0 14.25	– –	– –	1476.9	368.2	0.1553	27.91 61.53
EE722110	722186CD	9.7 0.38	321.0 12.64	1.5 0.06	432.9 17.04	28.58 1.13	11.91 0.47	1894.4	142.6	0.1669	121.64 268.18
EE295110	295192D	1.3 0.05	303.0 11.93	1.5 0.06	450.5 17.74	– –	– –	2247.3	171.9	0.1664	183.69 404.99
EE295110	295192CD	1.3 0.05	303.0 11.93	1.5 0.06	450.5 17.74	28.58 1.13	14.30 0.56	2247.3	171.9	0.1664	183.69 404.99
LM654642	LM654610CD	3.5 0.14	302.0 11.89	1.5 0.06	368.0 14.49	22.23 0.88	10.31 0.41	1916.4	265.6	0.1744	43.56 96.00
EE101103	101601CD	6.8 0.27	309.0 12.17	1.5 0.06	376.0 14.80	19.05 0.75	10.34 0.41	1380.2	226.7	0.1527	44.44 97.97
EE128110	128160CD	6.8 0.27	309.0 12.17	1.5 0.06	384.0 15.12	25.40 1.00	9.52 0.38	1727.7	255.2	0.1628	58.47 128.93
545112	545142CD	3.5 0.14	302.0 11.89	1.5 0.06	345.0 13.58	14.29 0.56	7.95 0.31	1015.9	545.5	0.1446	15.27 33.66
LM654649	LM654610CD	3.5 0.14	306.0 12.05	1.5 0.06	368.0 14.49	22.23 0.88	10.31 0.41	1916.4	265.6	0.1744	40.74 89.80
EE921124	921851D	9.7 0.38	325.0 12.80	1.5 0.06	440.2 17.33	– –	– –	1732.1	200.0	0.1481	103.89 229.04
EE921124	921876D	9.7 0.38	325.0 12.80	1.5 0.06	440.2 17.33	– –	– –	1732.1	200.0	0.1481	104.91 231.30
EE147112	147198D	6.4 0.25	329.0 12.95	3.3 0.13	468.1 18.43	– –	– –	1487.1	138.4	0.1954	142.84 314.94
M255449H	M255410CD	6.4 0.25	317.0 12.48	1.5 0.06	387.9 15.27	28.58 1.13	11.12 0.44	2301.3	287.6	0.1722	63.76 140.59
EE722115	722186CD	9.7 0.38	330.0 12.99	1.5 0.06	432.9 17.04	28.58 1.13	11.91 0.47	1894.4	142.6	0.1669	111.93 246.76
HM456949	HM456910CD	9.7 0.38	331.0 13.03	1.5 0.06	443.0 17.44	28.58 1.13	11.91 0.47	2134.9	153.5	0.1740	118.21 260.63

<sup>(4)</sup>These maximum fillet radii will be cleared by bearing corners.  
NOTE: For spacer configuration information, contact your Timken engineer.

# TAPERED ROLLER BEARINGS

## DOUBLE-ROW • TYPE TDO

### TYPE TDO



Bearing Dimensions				Load Ratings							
Bore d	O.D. D	Width T	Double Outer Ring Width C	Dynamic <sup>(1)</sup>				Dynamic <sup>(3)</sup>			
				C <sub>1(2)</sub>	e	Y <sub>1</sub>	Y <sub>2</sub>	C <sub>90</sub>	C <sub>a90</sub>	C <sub>90(2)</sub>	K
mm in.	mm in.	mm in.	mm in.	N lbf				N lbf	N lbf	N lbf	
292.100 11.5000	469.900 18.5000	200.025 7.8750	149.225 5.8750	3950000 887000	0.38	1.79	2.66	588000 132000	380000 85500	1020000 230000	1.55
292.100 11.5000	520.700 20.5000	228.600 9.0000	165.100 6.5000	3400000 765000	0.33	2.06	3.06	506000 114000	284000 63900	882000 198000	1.78
292.100 11.5000	558.800 22.0000	298.450 11.7500	222.250 8.7500	5390000 1210000	0.40	1.71	2.54	802000 180000	542000 122000	1400000 314000	1.48
298.450 11.7500	444.500 17.5000	146.050 5.7500	98.4250 3.8750	1540000 347000	0.38	1.79	2.66	230000 51700	149000 33400	400000 90000	1.55
299.975 11.8100	495.300 19.5000	301.625 11.8750	247.650 9.7500	5000000 1120000	0.33	2.03	3.02	744000 167000	423000 95200	1300000 291000	1.76
300.038 11.8125	422.275 16.6250	174.625 6.8750	136.525 5.3750	2260000 508000	0.34	2.00	2.99	336000 75600	194000 43600	586000 132000	1.73
300.038 11.8125	422.275 16.6250	174.625 6.8750	136.525 5.3750	2260000 508000	0.34	2.00	2.99	336000 75600	194000 43600	586000 132000	1.73
300.040 11.8126	496.000 19.5276	307.576 12.1092	253.600 9.9842	6270000 1410000	0.33	2.03	3.02	933000 210000	531000 119000	1630000 365000	1.76
304.800 12.0000	393.700 15.5000	107.950 4.2500	82.550 3.2500	1020000 229000	0.36	1.88	2.80	152000 34200	93500 21000	265000 59500	1.63
304.800 12.0000	412.750 16.2500	123.825 4.8750	92.075 3.6250	1080000 242000	0.43	1.58	2.35	160000 36000	117000 26300	279000 62700	1.37
304.800 12.0000	412.750 16.2500	158.750 6.2500	127.000 5.0000	1080000 242000	0.43	1.58	2.35	160000 36000	117000 26300	279000 62700	1.37
304.800 12.0000	438.048 17.2460	165.100 6.5000	120.650 4.7500	1560000 351000	0.42	1.62	2.42	232000 52200	165000 37200	405000 91000	1.40
304.8000 12.0000	444.5000 17.5000	146.050 5.7500	98.425 3.8750	1540000 347000	0.38	1.79	2.66	230000 51700	149000 33400	400000 90000	1.55
304.800 12.0000	444.500 17.5000	223.825 8.8120	176.200 6.9370	1540000 347000	0.38	1.79	2.66	230000 51700	149000 33400	400000 90000	1.55
304.800 12.0000	495.300 19.5000	162.245 6.3876	120.650 4.7500	2700000 607000	0.40	1.68	2.50	402000 90300	277000 62200	700000 157000	1.45
304.800 12.0000	495.300 19.5000	168.595 6.6376	127.000 5.0000	2700000 607000	0.40	1.68	2.50	402000 90300	277000 62200	700000 157000	1.45
304.800 12.0000	495.300 19.5000	196.850 7.7500	146.050 5.7500	2630000 591000	0.40	1.68	2.50	392000 88000	269000 60600	682000 153000	1.45

<sup>(1)</sup>Based on  $1 \times 10^6$  revolutions  $L_{10}$  life, for the ISO life-calculation method.  $C_{1(2)}$  is the double-row radial value.

<sup>(2)</sup>Consult your Timken engineer for instructions on use or review the Timken Engineering Manual on [timken.com/catalogs](http://timken.com/catalogs).

<sup>(3)</sup>Based on  $90 \times 10^6$  revolutions  $L_{10}$  life, for The Timken Company life-calculation method.  $C_{90}$  and  $C_{a90}$  are radial and thrust values for a single row.  $C_{90(2)}$  is the double-row radial value.

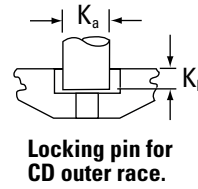
Part Number		Dimensions						Geometry Factors			Bearing Weight
Inner	Outer	Shaft		Housing		Pin		G <sub>1</sub>	G <sub>2</sub>	C <sub>G</sub>	
		Max. Shaft Fillet Radius R <sup>(4)</sup>	Backing Shoulder Dia. d <sub>b</sub>	Max. Housing Fillet Radius r <sup>(4)</sup>	Backing Shoulder Dia. D <sub>a</sub>	K <sub>a</sub>	K <sub>b</sub>				
		mm in.	mm in.	mm in.	mm in.	mm in.	mm in.				kg lbs.
NP911398	NP993155	9.7 0.38	331.0 13.03	1.5 0.06	443.0 17.44	28.58 1.13	11.91 0.47	2134.9	153.5	0.1740	118.73 261.77
EE224115	224205D	6.4 0.25	331.0 13.03	1.5 0.06	468.2 18.43	– –	– –	2630.1	228.6	0.1780	192.33 424.04
EE790114	790223D	6.4 0.25	335.0 13.19	1.5 0.06	514.2 20.24	– –	– –	2663.9	170.3	0.1898	297.82 656.59
EE291175	291751CD	8.00 0.31	332.00 13.07	1.50 0.06	413.89 16.30	22.23 0.88	11.91 0.47	1579.2	244.8	0.1557	65.59 144.62
HH258248	HH258210CD	6.4 0.25	342.0 13.46	1.5 0.06	467.0 18.40	28.58 1.13	14.30 0.56	3853.2	220.0	0.2048	229.10 505.10
HM256849	HM256810D	6.4 0.25	328.0 12.91	1.5 0.06	403.0 15.88	– –	– –	2548.4	281.8	0.1779	73.00 160.96
HM256849	HM256810CD	6.4 0.25	328.0 12.91	1.5 0.06	403.0 15.88	28.58 1.13	11.91 0.47	2548.4	281.8	0.1779	73.00 160.96
JHH258247	JHH258211CD	6.4 0.25	346.0 13.62	1.5 0.06	467.0 18.39	28.58 1.13	14.30 0.56	3853.2	220.0	0.2048	234.73 517.50
L357049	L357010CD	6.4 0.25	329.0 12.95	1.5 0.06	380.0 14.96	19.05 0.75	7.95 0.31	1753.3	301.0	0.1585	29.90 65.92
EE109120	109163D	6.4 0.25	330.0 12.99	1.5 0.06	394.4 15.53	– –	– –	1520.2	251.6	0.1598	39.79 87.72
EE109120	109161D	6.4 0.25	330.0 12.99	1.5 0.06	394.4 15.53	– –	– –	1520.2	251.6	0.1598	51.53 113.61
EE129120X	129173CD	6.4 0.25	334.0 13.15	1.5 0.06	411.0 16.20	26.98 1.06	11.12 0.44	1882.6	272.9	0.1711	70.21 154.78
EE291201	291751CD	8.00 0.31	337.00 13.27	1.50 0.06	413.89 16.30	22.23 0.88	11.91 0.47	1579.2	244.8	0.1557	62.72 138.26
EE291201	291753CD	8.0 0.31	337.0 13.27	1.5 0.06	414.0 16.30	22.23 0.88	11.91 0.47	1579.2	244.8	0.1557	92.94 204.88
EE941205	941951XD	6.4 0.25	339.0 13.35	1.5 0.06	463.4 18.25	– –	– –	1771.6	187.4	0.1657	106.66 235.12
EE941205	941953D	6.4 0.25	339.0 13.35	1.5 0.06	463.4 18.25	– –	– –	1771.6	187.4	0.1657	107.65 237.30
EE724119	724196CD	16.0 0.63	359.0 14.13	1.5 0.06	458.9 18.07	28.58 1.13	12.70 0.50	2242.3	170.0	0.1800	134.62 296.78

<sup>(4)</sup>These maximum fillet radii will be cleared by bearing corners.  
NOTE: For spacer configuration information, contact your Timken engineer.

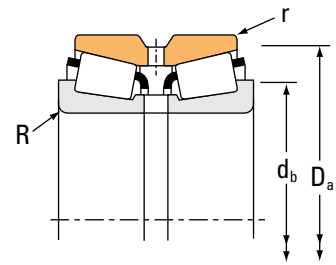
# TAPERED ROLLER BEARINGS

## DOUBLE-ROW • TYPE TDO

### TYPE TDO



Locking pin for CD outer race.



Bearing Dimensions				Load Ratings							
Bore d	O.D. D	Width T	Double Outer Ring Width C	Dynamic <sup>(1)</sup>				Dynamic <sup>(3)</sup>			
				C <sub>1(2)</sub>	e	Y <sub>1</sub>	Y <sub>2</sub>	C <sub>90</sub>	C <sub>a90</sub>	C <sub>90(2)</sub>	K
mm in.	mm in.	mm in.	mm in.	N lbf				N lbf	N lbf	N lbf	
304.800 12.0000	495.300 19.5000	196.850 7.7500	146.050 5.7500	2940000 660000	0.40	1.68	2.50	437000 98300	301000 67700	762000 171000	1.45
304.800 12.0000	558.800 22.0000	298.450 11.7500	222.250 8.7500	5390000 1210000	0.40	1.71	2.54	802000 180000	542000 122000	1400000 314000	1.48
311.150 12.2500	558.800 22.0000	190.500 7.5000	111.125 4.3750	2400000 540000	0.88	0.76	1.14	358000 80400	541000 122000	623000 140000	0.66
317.5000 12.5000	444.5000 17.5000	146.050 5.7500	98.425 3.8750	1540000 347000	0.38	1.79	2.66	230000 51700	149000 33400	400000 90000	1.55
317.500 12.5000	447.675 17.6250	180.975 7.1250	146.050 5.7500	3600000 808000	0.33	2.02	3.00	535000 120000	307000 69000	932000 210000	1.74
317.500 12.5000	447.675 17.6250	180.975 7.1250	146.050 5.7500	2920000 656000	0.33	2.02	3.00	435000 97800	249000 56000	757000 170000	1.74
317.500 12.5000	447.675 17.6250	180.975 7.1250	146.050 5.7500	2920000 656000	0.33	2.02	3.00	435000 97800	249000 56000	757000 170000	1.74
317.500 12.5000	622.300 24.5000	304.800 12.0000	174.625 6.8750	5500000 1240000	0.94	0.72	1.07	819000 184000	1310000 295000	1430000 321000	0.62
329.870 12.9870	533.400 21.0000	174.625 6.8750	123.825 4.8750	3010000 676000	0.33	2.03	3.02	448000 101000	255000 57300	780000 175000	1.76
329.870 12.9870	546.100 21.5000	177.800 7.0000	152.400 6.0000	3010000 676000	0.33	2.03	3.02	448000 101000	255000 57300	780000 175000	1.76
330.200 13.0000	415.925 16.3750	100.012 3.9375	74.612 2.9375	844000 190000	0.50	1.35	2.02	126000 28300	107000 24100	219000 49200	1.17
330.200 13.0000	415.925 16.3750	100.012 3.9375	74.612 2.9375	844000 190000	0.50	1.35	2.02	126000 28300	107000 24100	219000 49200	1.17
330.200 13.0000	482.600 19.0000	133.350 5.2500	88.900 3.5000	1090000 246000	0.50	1.35	2.01	163000 36600	140000 31400	284000 63800	1.17
330.200 13.0000	482.600 19.0000	177.800 7.0000	127.000 5.0000	2180000 489000	0.39	1.73	2.57	324000 72900	217000 48700	564000 127000	1.49
330.200 13.0000	482.600 19.0000	177.800 7.0000	127.000 5.0000	2180000 489000	0.39	1.73	2.57	324000 72900	217000 48700	564000 127000	1.49
330.200 13.0000	482.600 19.0000	177.800 7.0000	127.000 5.0000	2180000 489000	0.39	1.73	2.57	324000 72900	217000 48700	564000 127000	1.49
333.375 13.1250	469.900 18.5000	190.500 7.5000	152.400 6.0000	3930000 884000	0.33	2.02	3.00	586000 132000	336000 75500	1020000 229000	1.74

<sup>(1)</sup>Based on 1 x 10<sup>6</sup> revolutions L<sub>10</sub> life, for the ISO life-calculation method. C<sub>1(2)</sub> is the double-row radial value.

<sup>(2)</sup>Consult your Timken engineer for instructions on use or review the Timken Engineering Manual on [timken.com/catalogs](http://timken.com/catalogs).

<sup>(3)</sup>Based on 90 x 10<sup>6</sup> revolutions L<sub>10</sub> life, for The Timken Company life-calculation method. C<sub>90</sub> and C<sub>a90</sub> are radial and thrust values for a single row. C<sub>90(2)</sub> is the double-row radial value.

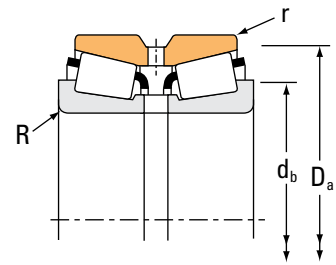
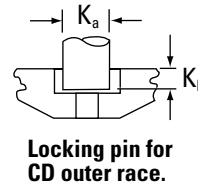
Part Number		Dimensions						Geometry Factors			Bearing Weight
Inner	Outer	Shaft		Housing		Pin		G <sub>1</sub>	G <sub>2</sub>	C <sub>G</sub>	
		Max. Shaft Fillet Radius R <sup>(4)</sup>	Backing Shoulder Dia. d <sub>b</sub>	Max. Housing Fillet Radius r <sup>(4)</sup>	Backing Shoulder Dia. D <sub>a</sub>	K <sub>a</sub>	K <sub>b</sub>				
		mm in.	mm in.	mm in.	mm in.	mm in.	mm in.				kg lbs.
EE724120	724196CD	16.0 0.63	359.0 14.13	1.5 0.06	458.9 18.07	28.58 1.13	12.70 0.50	2183.9	165.7	0.1783	128.48 283.25
EE790120	790223D	1.3 0.05	335.0 13.19	1.5 0.06	514.2 20.24	– –	– –	2663.9	170.3	0.1898	284.29 626.78
EE148122	148220D	9.7 0.38	361.0 14.21	3.3 0.13	488.4 19.23	– –	– –	1639.0	153.2	0.2048	169.43 373.55
EE291250	291751CD	8.00 0.31	346.00 13.62	1.50 0.06	413.89 16.30	22.23 0.88	11.91 0.47	1579.2	244.8	0.1557	55.22 121.76
DX760136	DX307395	3.5 0.14	341.0 13.43	1.5 0.06	428.0 16.85	28.58 1.13	11.91 0.47	2944.6	303.9	0.1863	85.74 189.03
HM259049	HM259010D	3.5 0.14	341.0 13.43	1.5 0.06	427.7 16.84			2944.6	303.9	0.1863	86.01 189.64
HM259049	HM259010CD	3.5 0.14	341.0 13.43	1.5 0.06	427.7 16.84	28.58 1.13	11.91 0.47	2944.6	303.9	0.1863	86.01 189.64
H961649	H961610CD	14.3 0.56	410.0 16.14	3.3 0.13	581.6 22.90	23.80 0.94	14.30 0.56	2502.7	149.1	0.2401	371.45 818.88
EE971298	972103D	4.8 0.19	364.0 14.33	1.5 0.06	496.3 19.54	– –	– –	2433.2	282.5	0.1730	134.71 296.99
EE971298	972151D	4.8 0.19	364.0 14.33	3.3 0.13	501.9 19.76	– –	– –	2433.2	282.5	0.1730	154.99 341.68
L860048	L860010CD	12.7 0.50	367.0 14.45	1.5 0.06	402.0 15.83	17.46 0.69	8.73 0.34	1823.3	479.1	0.1774	27.53 60.72
L860049	L860010CD	3.5 0.14	349.0 13.74	1.5 0.06	402.0 15.83	17.46 0.69	8.73 0.34	1823.3	479.1	0.1774	28.77 63.45
EE161300	161901CD	7.0 0.28	367.0 14.45	1.5 0.06	455.0 17.91	22.23 0.88	11.91 0.47	1730.8	299.6	0.1741	70.80 156.09
EE526130	526191CD	6.4 0.25	360.0 14.17	1.5 0.06	454.0 17.87	28.58 1.13	11.91 0.47	2283.3	287.2	0.1790	92.44 203.80
EE526130	526191D	6.4 0.25	360.0 14.17	1.5 0.06	454.0 17.87	– –	– –	2283.3	287.2	0.1790	92.97 204.96
EE526132	526191CD	3.3 0.13	354.0 13.94	1.5 0.06	454.0 17.87	28.58 1.13	11.91 0.47	2283.3	287.2	0.1790	92.46 203.85
DX135509	DX371163	6.4 0.25	363.0 14.29	1.5 0.06	449.0 17.69	28.58 1.13	11.91 0.47	3306.8	324.3	0.1935	95.33 210.17

<sup>(4)</sup>These maximum fillet radii will be cleared by bearing corners.  
NOTE: For spacer configuration information, contact your Timken engineer.

# TAPERED ROLLER BEARINGS

## DOUBLE-ROW • TYPE TDO

### TYPE TDO



Bearing Dimensions				Load Ratings							
Bore d	O.D. D	Width T	Double Outer Ring Width C	Dynamic <sup>(1)</sup>				Dynamic <sup>(3)</sup>			
				C <sub>1(2)</sub>	e	Y <sub>1</sub>	Y <sub>2</sub>	C <sub>90</sub>	C <sub>a90</sub>	C <sub>90(2)</sub>	K
mm in.	mm in.	mm in.	mm in.	N lbf				N lbf	N lbf	N lbf	
333.375 13.1250	469.900 18.5000	190.500 7.5000	152.400 6.0000	2780000 626000	0.33	2.02	3.00	415000 93200	238000 53400	722000 162000	1.74
333.375 13.1250	469.900 18.5000	190.500 7.5000	152.400 6.0000	2940000 661000	0.33	2.02	3.00	438000 98500	251000 56400	763000 171000	1.74
339.949 13.3838	579.948 22.8326	305.000 12.0079	241.000 9.4882	5890000 1320000	0.33	2.03	3.02	876000 197000	499000 112000	1530000 343000	1.76
339.949 13.3838	589.948 23.2263	340.000 13.3859	278.000 10.9449	6800000 1530000	0.33	2.03	3.02	1010000 227000	576000 130000	1760000 396000	1.76
342.900 13.5000	457.098 17.9960	142.875 5.6250	101.600 4.0000	1430000 322000	0.71	0.95	1.41	213000 48000	260000 58500	371000 83500	0.82
342.900 13.5000	457.098 17.9960	142.875 5.6250	101.600 4.0000	1430000 322000	0.71	0.95	1.41	213000 48000	260000 58500	371000 83500	0.82
342.900 13.5000	533.400 21.0000	165.100 6.5000	114.300 4.5000	3010000 676000	0.33	2.03	3.02	448000 101000	255000 57300	780000 175000	1.76
342.900 13.5000	533.400 21.0000	174.625 6.8750	114.300 4.5000	3010000 676000	0.33	2.03	3.02	448000 101000	255000 57300	780000 175000	1.76
342.900 13.5000	546.100 21.5000	177.800 7.0000	114.300 4.5000	3010000 676000	0.33	2.03	3.02	448000 101000	255000 57300	780000 175000	1.76
346.075 13.6250	482.600 19.0000	133.350 5.2500	88.900 3.5000	1090000 246000	0.50	1.35	2.01	163000 36600	140000 31400	284000 63800	1.17
346.075 13.6250	488.950 19.2500	200.025 7.8750	158.750 6.2500	3250000 730000	0.33	2.02	3.00	483000 109000	277000 62300	842000 189000	1.74
346.075 13.6250	488.950 19.2500	200.025 7.8750	158.750 6.2500	3010000 676000	0.33	2.02	3.00	448000 101000	257000 57700	780000 175000	1.74
349.250 13.7500	514.350 20.2500	193.675 7.6250	152.400 6.0000	2350000 529000	0.37	1.84	2.74	350000 78700	220000 49500	610000 137000	1.59
354.012 13.9375	482.600 19.0000	133.350 5.2500	88.900 3.5000	954000 214000	0.50	1.35	2.01	142000 31900	122000 27400	247000 55600	1.17
355.600 14.0000	444.500 17.5000	136.525 5.3750	111.125 4.3750	1280000 287000	0.31	2.20	3.27	190000 42700	100000 22500	331000 74400	1.90
355.600 14.0000	482.600 19.0000	133.350 5.2500	88.900 3.5000	1090000 246000	0.50	1.35	2.01	163000 36600	140000 31400	284000 63800	1.17
355.600 14.0000	501.650 19.7500	155.575 6.1250	107.950 4.2500	1830000 412000	0.44	1.53	2.28	273000 61300	206000 46200	475000 107000	1.33

<sup>(1)</sup>Based on 1 x 10<sup>6</sup> revolutions L<sub>10</sub> life, for the ISO life-calculation method. C<sub>1(2)</sub> is the double-row radial value.

<sup>(2)</sup>Consult your Timken engineer for instructions on use or review the Timken Engineering Manual on [timken.com/catalogs](http://timken.com/catalogs).

<sup>(3)</sup>Based on 90 x 10<sup>6</sup> revolutions L<sub>10</sub> life, for The Timken Company life-calculation method. C<sub>90</sub> and C<sub>a90</sub> are radial and thrust values for a single row. C<sub>90(2)</sub> is the double-row radial value.

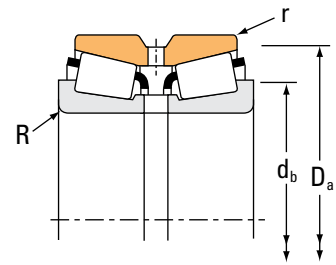
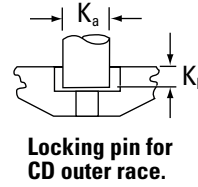
Part Number		Dimensions						Geometry Factors			Bearing Weight
Inner	Outer	Shaft		Housing		Pin		G <sub>1</sub>	G <sub>2</sub>	C <sub>g</sub>	
		Max. Shaft Fillet Radius R <sup>(4)</sup>	Backing Shoulder Dia. d <sub>b</sub>	Max. Housing Fillet Radius r <sup>(4)</sup>	Backing Shoulder Dia. D <sub>a</sub>	K <sub>a</sub>	K <sub>b</sub>				
		mm in.	mm in.	mm in.	mm in.	mm in.	mm in.				kg lbs.
HM261049	HM261010CD	6.4 0.25	363.0 14.29	1.5 0.06	449.5 17.70	28.58 1.13	11.91 0.47	3306.8	324.3	0.1935	99.90 220.23
HM261049H	HM261010CD	6.4 0.25	363.0 14.29	1.5 0.06	449.5 17.70	28.58 1.13	11.91 0.47	3045.1	299.8	0.1880	95.90 211.44
H263949	H263910D	14.0 0.55	396.0 15.59	3.5 0.14	540.0 21.27	– –	– –	4370.9	231.9	0.2126	318.99 703.30
HH264149	HH264110CD	14.0 0.55	402.0 15.83	3.5 0.14	552.0 21.73	28.58 1.13	15.09 0.59	5002.5	237.7	0.2228	381.14 840.26
LM961548	LM961511D	3.3 0.13	367.0 14.45	1.5 0.06	443.1 17.44	– –	– –	2281.5	300.4	0.2146	59.77 131.78
LM961548	LM961511CD	3.3 0.13	367.0 14.45	1.5 0.06	443.1 17.44	22.23 0.88	11.12 0.44	2281.5	300.4	0.2146	59.77 131.78
EE971354	972102CD	4.8 0.19	373.0 14.69	1.5 0.06	496.3 19.54	22.23 0.88	12.70 0.50	2433.2	282.5	0.1730	120.66 266.02
EE971354	972103D	4.8 0.19	373.0 14.69	1.5 0.06	496.3 19.54	– –	– –	2433.2	282.5	0.1730	121.86 268.68
EE971354	972151D	4.8 0.19	373.0 14.69	3.3 0.13	501.9 19.76	– –	– –	2433.2	282.5	0.1730	141.87 312.78
EE161363	161901CD	7.0 0.28	379.0 14.92	1.5 0.06	455.0 17.91	22.23 0.88	11.91 0.47	1730.8	299.6	0.1741	61.90 136.45
HM262748	HM262710CD	6.4 0.25	377.0 14.84	1.5 0.06	467.0 18.39	28.58 1.13	11.91 0.47	3430.8	322.6	0.1956	110.40 243.37
HM262749	HM262710CD	6.4 0.25	377.0 14.84	1.5 0.06	467.0 18.39	28.58 1.13	11.91 0.47	3646.2	341.8	0.1999	113.26 249.69
EE333137	333203CD	6.4 0.25	382.0 15.04	1.5 0.06	478.3 18.83	28.58 1.13	11.91 0.47	3037.5	334.7	0.1928	123.41 272.08
EE161394	161901CD	7.0 0.28	385.0 15.16	1.5 0.06	455.0 17.91	22.23 0.88	11.91 0.47	1730.8	299.6	0.1741	58.33 128.62
L163149	L163110CD	3.5 0.14	374.0 14.72	1.5 0.06	430.0 16.93	22.23 0.88	9.52 0.38	3207.7	621.3	0.1838	44.54 98.21
EE161400	161901CD	7.0 0.28	386.0 15.20	1.5 0.06	455.0 17.91	22.23 0.88	11.91 0.47	1730.8	299.6	0.1741	57.40 126.53
EE231400	231976CD	6.4 0.25	388.0 15.28	1.5 0.06	481.0 18.94	22.23 0.88	11.91 0.47	2386.0	366.8	0.1874	85.25 181.34

<sup>(4)</sup>These maximum fillet radii will be cleared by bearing corners.  
NOTE: For spacer configuration information, contact your Timken engineer.

# TAPERED ROLLER BEARINGS

## DOUBLE-ROW • TYPE TDO

### TYPE TDO



Bearing Dimensions				Load Ratings							
Bore d	O.D. D	Width T	Double Outer Ring Width C	Dynamic <sup>(1)</sup>				Dynamic <sup>(3)</sup>			
				C <sub>1(2)</sub>	e	Y <sub>1</sub>	Y <sub>2</sub>	C <sub>90</sub>	C <sub>a90</sub>	C <sub>90(2)</sub>	K
mm in.	mm in.	mm in.	mm in.	N lbf				N lbf	N lbf	N lbf	
355.600 14.0000	514.350 20.2500	155.575 6.1250	107.950 4.2500	1830000 412000	0.44	1.53	2.28	273000 61300	206000 46200	475000 107000	1.33
355.600 14.0000	514.350 20.2500	193.675 7.6250	152.400 6.0000	2350000 529000	0.37	1.84	2.74	350000 78700	220000 49500	610000 137000	1.59
368.249 14.4980	523.875 20.6250	214.312 8.4375	169.862 6.6875	4870000 1100000	0.33	2.03	3.02	725000 163000	413000 92900	1260000 284000	1.76
368.249 14.4980	523.875 20.6250	214.312 8.4375	169.862 6.6875	3960000 890000	0.33	2.03	3.02	589000 132000	335000 75400	1030000 231000	1.76
368.300 14.5000	596.900 23.5000	203.200 8.0000	133.350 5.2500	3090000 694000	0.41	1.63	2.42	460000 103000	326000 73400	801000 180000	1.41
371.475 14.6250	501.650 19.7500	155.575 6.1250	107.950 4.2500	1830000 412000	0.44	1.53	2.28	273000 61300	206000 46200	475000 107000	1.33
371.475 14.6250	514.350 20.2500	155.575 6.1250	107.950 4.2500	1830000 412000	0.44	1.53	2.28	273000 61300	206000 46200	475000 107000	1.33
377.825 14.8750	508.000 20.0000	139.700 5.5000	88.900 3.5000	1320000 296000	0.53	1.27	1.89	196000 44000	179000 40200	341000 76600	1.10
379.948 14.9586	659.925 25.9813	380.000 14.9606	309.997 12.2046	8320000 1870000	0.33	2.03	3.02	1240000 278000	705000 159000	2160000 485000	1.76
380.000 14.9606	620.000 24.4094	241.000 9.4882	172.000 6.7717	4870000 1090000	0.46	1.47	2.19	725000 163000	569000 128000	1260000 284000	1.27
381.000 15.0000	508.000 20.0000	139.700 5.5000	88.900 3.5000	1320000 296000	0.53	1.27	1.89	196000 44000	179000 40200	341000 76600	1.10
381.000 15.0000	546.100 21.5000	222.250 8.7500	177.800 7.0000	4860000 1090000	0.33	2.03	3.02	723000 163000	412000 92600	1260000 283000	1.76
381.000 15.0000	546.100 21.5000	222.250 8.7500	177.800 7.0000	3950000 887000	0.33	2.03	3.02	588000 132000	335000 75200	1020000 230000	1.76
381.000 15.0000	546.100 21.5000	222.250 8.7500	177.800 7.0000	4290000 963000	0.33	2.03	3.02	638000 143000	363000 81700	1110000 250000	1.76
381.000 15.0000	590.550 23.2500	244.475 9.6250	193.675 7.6250	4970000 1120000	0.33	2.03	3.02	740000 166000	421000 94800	1290000 290000	1.76
381.000 15.0000	590.550 23.2500	244.475 9.6250	193.675 7.6250	4970000 1120000	0.33	2.03	3.02	740000 166000	421000 94800	1290000 290000	1.76
384.175 15.1250	546.100 21.5000	222.250 8.7500	177.800 7.0000	3950000 887000	0.33	2.03	3.02	588000 132000	335000 75200	1020000 230000	1.76

<sup>(1)</sup>Based on  $1 \times 10^6$  revolutions  $L_{10}$  life, for the ISO life-calculation method.  $C_{1(2)}$  is the double-row radial value.

<sup>(2)</sup>Consult your Timken engineer for instructions on use or review the Timken Engineering Manual on [timken.com/catalogs](http://timken.com/catalogs).

<sup>(3)</sup>Based on  $90 \times 10^6$  revolutions  $L_{10}$  life, for The Timken Company life-calculation method.  $C_{90}$  and  $C_{a90}$  are radial and thrust values for a single row.  $C_{90(2)}$  is the double-row radial value.



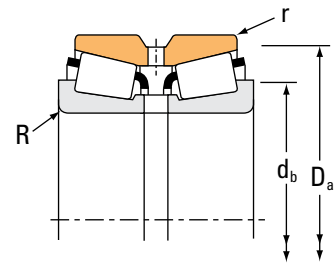
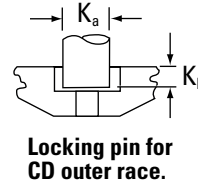
Part Number		Dimensions						Geometry Factors			Bearing Weight
Inner	Outer	Shaft		Housing		Pin		G <sub>1</sub>	G <sub>2</sub>	C <sub>g</sub>	
		Max. Shaft Fillet Radius R <sup>(4)</sup>	Backing Shoulder Dia. d <sub>b</sub>	Max. Housing Fillet Radius r <sup>(4)</sup>	Backing Shoulder Dia. D <sub>a</sub>	K <sub>a</sub>	K <sub>b</sub>				
		mm in.	mm in.	mm in.	mm in.	mm in.	mm in.				kg lbs.
EE231400	232026D	6.4 0.25	388.0 15.28	1.5 0.06	481.1 18.94	– –	– –	2386.0	366.8	0.1874	89.44 197.21
EE333140	333203CD	6.4 0.25	387.0 15.24	1.5 0.06	478.3 18.83	28.58 1.13	11.91 0.47	3037.5	334.7	0.1928	117.34 258.71
DX418857	DX748779	6.4 0.25	400.0 15.75	1.5 0.06	499.0 19.63	28.58 1.13	11.91 0.47	4297.3	412.9	0.2106	141.29 311.48
HM265049	HM265010CD	6.4 0.25	400.0 15.75	1.5 0.06	499.0 19.65	28.58 1.13	11.91 0.47	4297.3	412.9	0.2106	143.00 315.22
EE181453	182351D	9.7 0.38	415.0 16.34	2.3 0.09	551.6 21.72	– –	– –	2961.8	271.9	0.1984	194.15 428.02
EE231462	231976CD	6.4 0.25	400.0 15.75	1.5 0.06	481.0 18.94	22.23 0.88	11.91 0.47	2386.0	366.8	0.1874	71.79 158.27
EE231462	232026D	6.4 0.25	400.0 15.75	1.5 0.06	481.1 18.94	– –	– –	2386.0	366.8	0.1874	79.98 176.33
EE192148	192201CD	6.4 0.25	408.0 16.06	1.5 0.06	482.0 18.98	19.05 0.75	10.34 0.41	2288.0	398.1	0.1951	67.31 148.42
HH267648	HH267610D	14.0 0.55	423.9 16.69	3.5 0.14	616.0 24.25	– –	– –	6505.2	275.8	0.2430	533.08 1175.27
NP262883	NP789786	6.0 0.24	423.0 16.65	3.0 0.12	583.5 22.97	28.58 1.13	15.09 0.59	3473.0	238.6	0.2168	257.50 567.36
EE192150	192201CD	6.4 0.25	410.0 16.14	1.5 0.06	482.0 18.98	19.05 0.75	10.34 0.41	2288.0	398.1	0.1951	65.35 144.10
DX355312	DX295661	6.4 0.25	415.0 16.34	1.5 0.06	520.0 20.47	28.58 1.13	11.91 0.47	4383.4	278.7	0.2116	156.78 345.62
HM266446	HM266410CD	6.4 0.25	415.0 16.34	1.5 0.06	520.0 20.47	28.58 1.13	11.91 0.47	4383.4	278.7	0.2116	156.78 345.62
HM266447	HM266410CD	6.4 0.25	415.0 16.34	1.5 0.06	520.0 20.47	28.58 1.13	11.91 0.47	4760.1	301.5	0.2178	163.26 359.89
M268730	M268710D	6.4 0.25	425.0 16.73	1.5 0.06	562.0 22.13	– –	– –	5754.9	420.9	0.2319	245.77 541.82
M268730	M268710CD	6.4 0.25	425.0 16.73	1.5 0.06	562.0 22.13	28.58 1.13	14.30 0.56	5754.9	420.9	0.2319	245.77 541.82
HM266448	HM266410CD	6.4 0.25	417.0 16.42	1.5 0.06	520.0 20.47	28.58 1.13	11.91 0.47	4383.4	278.7	0.2116	153.74 338.94

<sup>(4)</sup>These maximum fillet radii will be cleared by bearing corners.  
NOTE: For spacer configuration information, contact your Timken engineer.

# TAPERED ROLLER BEARINGS

## DOUBLE-ROW • TYPE TDO

### TYPE TDO



Bearing Dimensions				Load Ratings							
Bore d	O.D. D	Width T	Double Outer Ring Width C	Dynamic <sup>(1)</sup>				Dynamic <sup>(3)</sup>			
				C <sub>1(2)</sub>	e	Y <sub>1</sub>	Y <sub>2</sub>	C <sub>90</sub>	C <sub>a90</sub>	C <sub>90(2)</sub>	K
mm in.	mm in.	mm in.	mm in.	N lbf				N lbf	N lbf	N lbf	
384.175 15.1250	546.100 21.5000	222.250 8.7500	177.800 7.0000	4290000 963000	0.33	2.03	3.02	638000 143000	363000 81700	1110000 250000	1.76
385.762 15.1875	514.350 20.2500	177.800 7.0000	139.700 5.5000	2360000 530000	0.42	1.61	2.40	351000 78900	251000 56500	611000 137000	1.40
385.762 15.1875	514.350 20.2500	177.800 7.0000	139.700 5.5000	2360000 530000	0.42	1.61	2.40	351000 78900	251000 56500	611000 137000	1.40
387.248 15.2460	546.100 21.5000	185.738 7.3125	147.638 5.8125	3250000 731000	0.42	1.62	2.41	484000 109000	346000 77800	843000 190000	1.40
393.700 15.5000	539.750 21.2500	142.875 5.6250	101.600 4.0000	1890000 425000	0.48	1.42	2.11	282000 63300	230000 51600	490000 110000	1.23
393.700 15.5000	546.100 21.5000	158.750 6.2500	117.475 4.6250	1890000 425000	0.48	1.42	2.11	282000 63300	230000 51600	490000 110000	1.23
393.700 15.5000	558.800 22.0000	146.050 5.7500	104.775 4.1250	1890000 425000	0.48	1.42	2.11	282000 63300	230000 51600	490000 110000	1.23
396.875 15.6250	539.750 21.2500	142.875 5.6250	101.600 4.0000	1890000 425000	0.48	1.42	2.11	282000 63300	230000 51600	490000 110000	1.23
396.875 15.6250	546.100 21.5000	158.750 6.2500	117.475 4.6250	1890000 425000	0.48	1.42	2.11	282000 63300	230000 51600	490000 110000	1.23
396.875 15.6250	558.800 22.0000	146.050 5.7500	104.775 4.1250	1890000 425000	0.48	1.42	2.11	282000 63300	230000 51600	490000 110000	1.23
406.400 16.0000	539.750 21.2500	142.875 5.6250	101.600 4.0000	1890000 425000	0.48	1.42	2.11	282000 63300	230000 51600	490000 110000	1.23
406.400 16.0000	546.100 21.5000	158.750 6.2500	117.475 4.6250	1890000 425000	0.48	1.42	2.11	282000 63300	230000 51600	490000 110000	1.23
406.400 16.0000	546.100 21.5000	185.738 7.3125	147.638 5.8125	3250000 731000	0.42	1.62	2.41	484000 109000	346000 77800	843000 190000	1.40
406.400 16.0000	558.800 22.0000	146.050 5.7500	104.775 4.1250	1890000 425000	0.48	1.42	2.11	282000 63300	230000 51600	490000 110000	1.23
406.400 16.0000	574.675 22.6250	157.162 6.1875	106.362 4.1875	1930000 434000	0.50	1.36	2.02	287000 64600	245000 55000	500000 112000	1.17
406.400 16.0000	609.524 23.9970	177.800 7.0000	133.350 5.2500	2990000 673000	0.35	1.94	2.89	446000 100000	265000 59600	776000 175000	1.68
406.400 16.0000	609.600 24.0000	187.325 7.3750	123.825 4.8750	3210000 721000	0.38	1.76	2.62	477000 107000	313000 70400	831000 187000	1.52

<sup>(1)</sup>Based on 1 x 10<sup>6</sup> revolutions L<sub>10</sub> life, for the ISO life-calculation method. C<sub>1(2)</sub> is the double-row radial value.

<sup>(2)</sup>Consult your Timken engineer for instructions on use or review the Timken Engineering Manual on [timken.com/catalogs](http://timken.com/catalogs).

<sup>(3)</sup>Based on 90 x 10<sup>6</sup> revolutions L<sub>10</sub> life, for The Timken Company life-calculation method. C<sub>90</sub> and C<sub>a90</sub> are radial and thrust values for a single row. C<sub>90(2)</sub> is the double-row radial value.

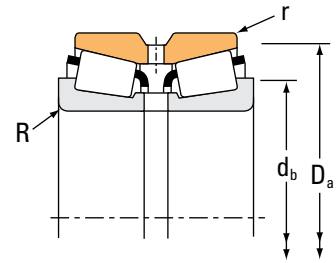
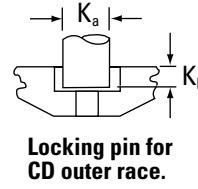
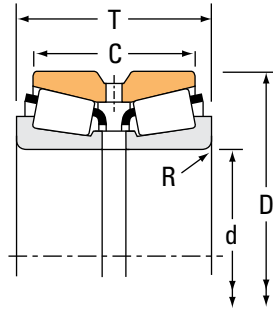
Part Number		Dimensions						Geometry Factors			Bearing Weight
Inner	Outer	Shaft		Housing		Pin		G <sub>1</sub>	G <sub>2</sub>	C <sub>g</sub>	
		Max. Shaft Fillet Radius R <sup>(4)</sup>	Backing Shoulder Dia. d <sub>b</sub>	Max. Housing Fillet Radius r <sup>(4)</sup>	Backing Shoulder Dia. D <sub>a</sub>	K <sub>a</sub>	K <sub>b</sub>				
		mm in.	mm in.	mm in.	mm in.	mm in.	mm in.				kg lbs.
HM266449	HM266410CD	6.4 0.25	417.0 16.42	1.5 0.06	520.0 20.47	28.58 1.13	11.91 0.47	4760.1	301.5	0.2178	160.48 353.79
LM665949	LM665910CD	6.4 0.25	415.0 16.34	1.5 0.06	495.0 19.49	28.58 1.13	12.70 0.50	3743.4	480.0	0.2155	94.11 207.47
LM665949A	LM665910CD	15.0 0.59	433.0 17.05	1.5 0.06	495.0 19.49	28.58 1.13	12.70 0.50	3743.4	480.0	0.2155	91.89 202.57
M667935	M667911D	6.4 0.25	424.0 16.69	1.5 0.06	526.7 20.74	– –	– –	4639.7	498.9	0.2316	137.90 304.03
EE234154	234213CD	6.4 0.25	426.0 16.77	1.5 0.06	515.6 20.30	22.23 0.88	12.70 0.50	2782.9	448.6	0.2018	84.08 185.38
EE234154	234216D	6.4 0.25	426.0 16.77	1.5 0.06	515.6 20.30	– –	– –	2782.9	448.6	0.2018	96.46 212.66
EE234154	234221D	6.4 0.25	426.0 16.77	1.5 0.06	515.6 20.30	– –	– –	2782.9	448.6	0.2018	99.60 219.59
EE234156	234213CD	6.4 0.25	428.0 16.85	1.5 0.06	515.6 20.30	22.23 0.88	12.70 0.50	2782.9	448.6	0.2018	82.08 180.94
EE234156	234216D	6.4 0.25	428.0 16.85	1.5 0.06	515.6 20.30	– –	– –	2782.9	448.6	0.2018	94.09 207.42
EE234156	234221D	6.4 0.25	428.0 16.85	1.5 0.06	515.6 20.30	– –	– –	2782.9	448.6	0.2018	93.63 206.41
EE234160	234213CD	6.4 0.25	435.0 17.13	1.5 0.06	515.6 20.30	22.23 0.88	12.70 0.50	2782.9	448.6	0.2018	75.55 166.56
EE234160	234216D	6.4 0.25	435.0 17.13	1.5 0.06	515.6 20.30	– –	– –	2782.9	448.6	0.2018	82.56 182.02
M667944	M667911D	6.4 0.25	438.0 17.24	1.5 0.06	526.7 20.74	– –	– –	4639.7	498.9	0.2316	118.91 262.18
EE234160	234221D	6.4 0.25	435.0 17.13	1.5 0.06	515.6 20.30	– –	– –	2782.9	448.6	0.2018	88.09 194.20
EE285160	285228D	6.8 0.27	442.0 17.40	1.5 0.06	534.0 21.02	– –	– –	3036.6	478.1	0.2103	111.45 245.70
EE736160	736239D	8.0 0.31	449.0 17.68	1.5 0.06	576.1 22.68	– –	– –	4176.8	536.6	0.2096	167.71 369.77
EE911600	912401D	6.8 0.27	443.0 17.44	1.5 0.06	569.0 22.40	– –	– –	3251.1	349.1	0.1990	162.55 358.39

<sup>(4)</sup>These maximum fillet radii will be cleared by bearing corners.  
NOTE: For spacer configuration information, contact your Timken engineer.

# TAPERED ROLLER BEARINGS

## DOUBLE-ROW • TYPE TDO

### TYPE TDO



Bearing Dimensions				Load Ratings							
Bore d	O.D. D	Width T	Double Outer Ring Width C	Dynamic <sup>(1)</sup>				Dynamic <sup>(3)</sup>			
				C <sub>1(2)</sub>	e	Y <sub>1</sub>	Y <sub>2</sub>	C <sub>90</sub>	C <sub>a90</sub>	C <sub>90(2)</sub>	K
mm in.	mm in.	mm in.	mm in.	N lbf				N lbf	N lbf	N lbf	
406.400 16.0000	673.100 26.5000	192.639 7.5842	127.000 5.0000	3540000 797000	0.40	1.68	2.50	528000 119000	363000 81700	919000 207000	1.45
406.400 16.0000	762.000 30.0000	368.300 14.5000	222.250 8.7500	7280000 1640000	0.94	0.72	1.07	1080000 244000	1740000 391000	1890000 425000	0.62
409.575 16.1250	574.675 22.6250	157.162 6.1875	106.362 4.1875	1930000 434000	0.50	1.36	2.02	287000 64600	245000 55000	500000 112000	1.17
409.575 16.1250	635.000 25.0000	257.175 10.1250	206.375 8.1250	5700000 1280000	0.33	2.03	3.02	849000 191000	484000 109000	1480000 332000	1.76
411.162 16.1875	609.600 24.0000	187.325 7.3750	123.825 4.8750	3210000 721000	0.38	1.76	2.62	477000 107000	313000 70400	831000 187000	1.52
415.925 16.3750	590.550 23.2500	244.475 9.6250	193.675 7.6250	4970000 1120000	0.33	2.03	3.02	740000 166000	421000 94800	1290000 290000	1.76
415.925 16.3750	590.550 23.2500	244.475 9.6250	193.675 7.6250	4970000 1120000	0.33	2.03	3.02	740000 166000	421000 94800	1290000 290000	1.76
425.450 16.7500	685.698 26.9960	311.150 12.2500	234.950 9.2500	5450000 1230000	0.40	1.68	2.50	812000 183000	559000 126000	1410000 318000	1.45
430.212 16.9375	603.250 23.7500	153.289 6.0350	98.425 3.8750	1960000 441000	0.52	1.29	1.92	292000 65700	262000 59000	509000 114000	1.11
430.212 16.9375	603.250 23.7500	159.639 6.2850	104.775 4.1250	1960000 441000	0.52	1.29	1.92	292000 65700	262000 59000	509000 114000	1.11
431.800 17.0000	571.500 22.5000	155.575 6.1250	111.125 4.3750	2140000 481000	0.55	1.24	1.84	319000 71700	298000 67000	555000 125000	1.07
431.800 17.0000	571.500 22.5000	192.090 7.5626	146.050 5.7500	3320000 747000	0.44	1.54	2.29	495000 111000	371000 83500	862000 194000	1.33
431.800 17.0000	603.250 23.7500	153.289 6.0350	98.425 3.8750	1960000 441000	0.52	1.29	1.92	292000 65700	262000 59000	509000 114000	1.11
431.800 17.0000	603.250 23.7500	159.639 6.2850	104.775 4.1250	1960000 441000	0.52	1.29	1.92	292000 65700	262000 59000	509000 114000	1.11
431.800 17.0000	673.100 26.5000	192.639 7.5842	127.000 5.0000	3540000 797000	0.40	1.68	2.50	528000 119000	363000 81700	919000 207000	1.45
431.800 17.0000	673.100 26.5000	192.639 7.5842	127.000 5.0000	3540000 797000	0.40	1.68	2.50	528000 119000	363000 81700	919000 207000	1.45
431.902 17.0040	685.698 26.9960	365.125 14.3750	295.275 11.6250	8080000 1820000	0.32	2.08	3.09	1200000 270000	669000 150000	2090000 471000	1.80

<sup>(1)</sup>Based on 1 x 10<sup>6</sup> revolutions L<sub>10</sub> life, for the ISO life-calculation method. C<sub>1(2)</sub> is the double-row radial value.

<sup>(2)</sup>Consult your Timken engineer for instructions on use or review the Timken Engineering Manual on [timken.com/catalogs](http://timken.com/catalogs).

<sup>(3)</sup>Based on 90 x 10<sup>6</sup> revolutions L<sub>10</sub> life, for The Timken Company life-calculation method. C<sub>90</sub> and C<sub>a90</sub> are radial and thrust values for a single row. C<sub>90(2)</sub> is the double-row radial value.

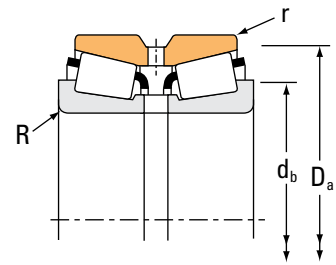
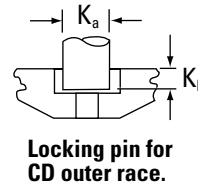
Part Number		Dimensions						Geometry Factors			Bearing Weight
Inner	Outer	Shaft		Housing		Pin		G <sub>1</sub>	G <sub>2</sub>	C <sub>G</sub>	
		Max. Shaft Fillet Radius R <sup>(4)</sup>	Backing Shoulder Dia. d <sub>b</sub>	Max. Housing Fillet Radius r <sup>(4)</sup>	Backing Shoulder Dia. D <sub>a</sub>	K <sub>a</sub>	K <sub>b</sub>				
		mm in.	mm in.	mm in.	mm in.	mm in.	mm in.				kg lbs.
EE571602	572651D	6.4 0.25	453.0 17.83	1.5 0.06	629.5 24.78	– –	– –	3621.0	321.8	0.2093	240.38 529.94
H969249	H969210D	12.7 0.50	513.0 20.20	3.3 0.13	719.3 28.32	– –	– –	4614.9	207.4	0.2945	683.72 1507.37
EE285162	285228D	6.8 0.27	444.0 17.48	1.5 0.06	534.0 21.02	– –	– –	3036.6	478.1	0.2103	108.57 239.37
M270730	M270710CD	6.4 0.25	456.0 17.95	1.5 0.06	605.1 23.82	28.58 1.13	15.09 0.59	6865.6	481.9	0.2458	299.30 659.86
EE911618	912401D	6.8 0.27	447.0 17.60	1.5 0.06	569.0 22.40	– –	– –	3251.1	349.1	0.1990	156.34 344.71
M268749	M268710D	6.4 0.25	451.0 17.76	1.5 0.06	562.0 22.13	– –	– –	5754.9	420.9	0.2319	205.62 453.31
M268749	M268710CD	6.4 0.25	451.0 17.76	1.5 0.06	562.0 22.13	28.58 1.13	14.30 0.55	5754.9	420.9	0.2319	205.62 453.31
EE328167	328268D	12.7 0.50	482.0 18.98	3.3 0.13	636.1 25.04	– –	– –	5606.6	353.0	0.2443	404.83 892.55
EE241693	242376D	6.4 0.25	465.0 18.31	1.5 0.06	561.0 22.09	– –	– –	3353.8	551.6	0.2207	116.48 256.77
EE241693	242377CD	6.4 0.25	465.0 18.31	1.5 0.06	561.0 22.09	22.23 0.88	13.48 0.53	3353.8	551.6	0.2207	121.28 267.33
LM869448	LM869410CD	3.3 0.13	457.0 17.99	1.5 0.06	549.0 21.61	22.23 0.88	11.91 0.47	3719.4	491.5	0.2326	97.85 215.69
LM769349X	LM769310D	8.0 0.31	466.0 18.35	1.5 0.06	550.2 21.66	– –	– –	5114.6	614.2	0.2426	127.45 280.99
EE241701	242376D	6.4 0.25	446.0 18.35	1.5 0.06	561.0 22.09	– –	– –	3353.8	551.6	0.2207	116.79 257.47
EE241701	242377CD	6.4 0.25	446.0 18.35	1.5 0.06	561.0 22.09	22.23 0.88	13.48 0.53	3353.8	551.6	0.2207	120.47 265.58
EE571703	572651CD	6.4 0.25	472.0 18.58	1.5 0.06	629.5 24.78	25.40 1.00	15.09 0.59	3621.0	321.8	0.2093	220.94 487.09
EE571703	572651D	6.4 0.25	472.0 18.58	1.5 0.06	629.5 24.78	– –	– –	3621.0	321.8	0.2093	217.39 479.25
EE650170	650270D	6.4 0.25	477.0 18.78	3.3 0.13	648.5 25.53	– –	– –	7668.4	341.3	0.2542	502.35 1107.48

<sup>(4)</sup>These maximum fillet radii will be cleared by bearing corners.  
NOTE: For spacer configuration information, contact your Timken engineer.

# TAPERED ROLLER BEARINGS

## DOUBLE-ROW • TYPE TDO

### TYPE TDO



Bearing Dimensions				Load Ratings							
Bore d	O.D. D	Width T	Double Outer Ring Width C	Dynamic <sup>(1)</sup>		Factors <sup>(2)</sup>		Dynamic <sup>(3)</sup>			Factors <sup>(2)</sup>
				C <sub>1(2)</sub>	e	Y <sub>1</sub>	Y <sub>2</sub>	C <sub>90</sub>	C <sub>a90</sub>	C <sub>90(2)</sub>	K
mm in.	mm in.	mm in.	mm in.	N lbf				N lbf	N lbf	N lbf	
441.325 17.3750	660.400 26.0000	195.262 7.6875	138.112 5.4375	3070000 689000	0.37	1.80	2.69	457000 103000	292000 65700	795000 179000	1.56
441.325 17.3750	660.400 26.0000	195.262 7.6875	138.112 5.4375	3070000 689000	0.37	1.80	2.69	457000 103000	292000 65700	795000 179000	1.56
444.500 17.5000	517.525 20.3750	73.025 2.8750	53.975 2.1250	533000 120000	0.41	1.64	2.44	79300 17800	55800 12600	138000 31000	1.42
447.675 17.6250	635.000 25.0000	257.175 10.1250	206.375 8.1250	570000 1280000	0.33	2.03	3.02	849000 191000	484000 109000	1480000 332000	1.76
447.675 17.6250	649.925 25.5876	257.175 10.1250	206.375 8.1250	570000 1280000	0.33	2.03	3.02	849000 191000	484000 109000	1480000 332000	1.76
457.200 18.0000	596.900 23.5000	165.100 6.5000	120.650 4.7500	2460000 554000	0.40	1.67	2.48	367000 82400	254000 57100	639000 144000	1.44
457.200 18.0000	615.950 24.2500	184.150 7.2500	146.050 5.7500	3380000 760000	0.33	2.03	3.02	503000 113000	286000 64400	876000 197000	1.76
457.200 18.0000	660.400 26.0000	195.262 7.6875	138.112 5.4375	3070000 689000	0.37	1.80	2.69	457000 103000	292000 65700	795000 179000	1.56
457.200 18.0000	660.400 26.0000	195.262 7.6875	138.112 5.4375	3070000 689000	0.37	1.80	2.69	457000 103000	292000 65700	795000 179000	1.56
457.200 18.0000	660.400 26.0000	228.600 9.0000	171.450 6.7500	4340000 976000	0.32	2.12	3.15	646000 145000	353000 79300	1130000 253000	1.83
457.200 18.0000	730.148 28.7460	254.000 10.0000	177.800 7.0000	4920000 1110000	0.39	1.72	2.56	733000 165000	492000 111000	1280000 287000	1.49
476.250 18.7500	565.150 22.2500	95.250 3.7500	76.200 3.0000	817000 184000	0.47	1.44	2.14	122000 27400	97800 22000	212000 47600	1.24
479.425 18.8750	679.450 26.7500	276.225 10.8750	225.250 8.7500	6500000 1460000	0.33	2.03	3.02	968000 218000	551000 124000	1680000 379000	1.76
479.425 18.8750	679.450 26.7500	276.225 10.8750	225.250 8.7500	6500000 1460000	0.33	2.03	3.02	968000 218000	551000 124000	1680000 379000	1.76
482.600 19.0000	615.950 24.2500	184.150 7.2500	146.050 5.7500	2950000 662000	0.33	2.03	3.02	439000 98600	250000 56100	764000 172000	1.76
482.600 19.0000	615.950 24.2500	184.150 7.2500	146.050 5.7500	2950000 662000	0.33	2.03	3.02	439000 98600	250000 56100	764000 172000	1.76
482.600 19.0000	634.873 24.9950	177.800 7.0000	142.875 5.6250	2560000 574000	0.34	1.97	2.93	380000 85500	223000 50200	662000 149000	1.70

<sup>(1)</sup>Based on 1 x 10<sup>6</sup> revolutions L<sub>10</sub> life, for the ISO life-calculation method. C<sub>1(2)</sub> is the double-row radial value.

<sup>(2)</sup>Consult your Timken engineer for instructions on use or review the Timken Engineering Manual on [timken.com/catalogs](http://timken.com/catalogs).

<sup>(3)</sup>Based on 90 x 10<sup>6</sup> revolutions L<sub>10</sub> life, for The Timken Company life-calculation method. C<sub>90</sub> and C<sub>a90</sub> are radial and thrust values for a single row. C<sub>90(2)</sub> is the double-row radial value.

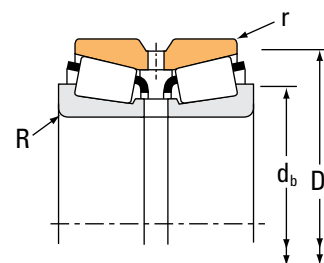
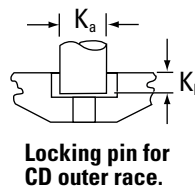
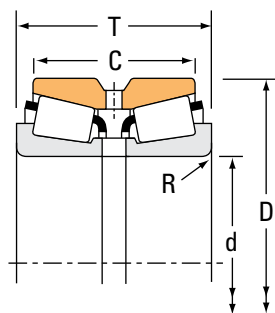
Part Number		Dimensions						Geometry Factors			Bearing Weight
Inner	Outer	Shaft		Housing		Pin		G <sub>1</sub>	G <sub>2</sub>	C <sub>g</sub>	
		Max. Shaft Fillet Radius R <sup>(4)</sup>	Backing Shoulder Dia. d <sub>b</sub>	Max. Housing Fillet Radius r <sup>(4)</sup>	Backing Shoulder Dia. D <sub>a</sub>	K <sub>a</sub>	K <sub>b</sub>				
		mm in.	mm in.	mm in.	mm in.	mm in.	mm in.				kg lbs.
EE737173	737261CD	10.5 0.41	491.0 19.33	1.5 0.06	618.2 24.34	28.58 1.13	14.96 0.59	4809.1	573.4	0.2247	213.82 471.41
EE737173	737261D	10.5 0.41	491.0 19.33	1.5 0.06	618.2 24.34	– –	– –	4809.1	573.4	0.2247	206.89 456.13
LL669849	LL669810XD	3.5 0.14	461.0 18.15	1.5 0.06	504.0 19.84	– –	– –	2969.3	1487.2	0.2443	23.11 50.97
M270749	M270710CD	6.4 0.25	484.0 19.06	1.5 0.06	605.1 23.82	28.58 1.13	15.09 0.59	6865.6	481.9	0.2458	249.52 550.08
M270749	M270720D	6.4 0.25	484.0 19.06	1.5 0.06	605.1 23.82	– –	– –	6865.6	481.9	0.2458	279.40 615.96
EE244180	244236CD	9.7 0.38	494.0 19.45	1.5 0.06	570.0 22.47	28.58 1.13	11.91 0.47	4411.8	627.1	0.2233	105.70 232.99
LM272235	LM272210CD	6.4 0.25	493.0 19.41	1.5 0.06	597.0 23.48	28.58 1.13	10.34 0.41	6037.2	665.8	0.2333	148.11 326.50
EE737181	737261CD	10.5 0.41	503.9 19.84	1.5 0.06	618.2 24.34	28.58 1.13	14.96 0.59	4809.1	573.4	0.2247	199.03 438.77
EE737181	737261D	10.5 0.41	503.9 19.84	1.5 0.06	618.2 24.34	– –	– –	4809.1	573.4	0.2247	191.83 422.91
M271648	M271610D	6.4 0.25	493.0 19.41	1.5 0.06	629.1 24.77	– –	– –	5273.7	413.3	0.2208	230.13 507.36
EE671801	672875D	9.7 0.38	507.0 19.96	1.5 0.06	681.0 26.79	– –	– –	4968.3	343.4	0.2315	365.77 806.41
LL771948	LL771911CD	3.3 0.13	495.0 19.49	1.5 0.06	549.0 21.61	17.46 0.69	9.52 0.38	3792.4	1237.1	0.2189	42.52 93.75
M272749	M272710D	6.4 0.25	516.0 20.31	1.5 0.06	648.0 25.52	– –	– –	8110.8	508.6	0.2598	309.29 681.86
M272749	M272710CD	6.4 0.25	516.0 20.31	1.5 0.06	648.0 25.52	33.35 1.31	17.47 0.69	8110.8	508.6	0.2598	309.29 681.86
LM272249	LM272210D	6.4 0.25	513.0 20.20	1.5 0.06	597.0 23.48	– –	– –	6037.2	665.8	0.2333	122.39 269.82
LM272249	LM272210CD	6.4 0.25	513.0 20.20	1.5 0.06	597.0 23.48	28.58 1.13	10.34 0.41	6037.2	665.8	0.2333	122.39 269.82
EE243190	243251CD	6.4 0.25	516.0 20.31	1.5 0.06	609.0 24.00	28.58 1.13	13.48 0.53	6057.3	726.6	0.2350	140.99 310.85

<sup>(4)</sup>These maximum fillet radii will be cleared by bearing corners.  
NOTE: For spacer configuration information, contact your Timken engineer.

# TAPERED ROLLER BEARINGS

## DOUBLE-ROW • TYPE TDO

### TYPE TDO



Bearing Dimensions				Load Ratings							
Bore d	O.D. D	Width T	Double Outer Ring Width C	Dynamic <sup>(1)</sup>		Factors <sup>(2)</sup>		Dynamic <sup>(3)</sup>			Factors <sup>(2)</sup>
				C <sub>1(2)</sub>	e	Y <sub>1</sub>	Y <sub>2</sub>	C <sub>90</sub>	C <sub>a90</sub>	C <sub>90(2)</sub>	K
mm in.	mm in.	mm in.	mm in.	N lbf				N lbf	N lbf	N lbf	
482.600 19.0000	634.873 24.9950	177.800 7.0000	142.875 5.6250	2560000 574000	0.34	1.97	2.93	380000 85500	223000 50200	662000 149000	1.70
488.671 19.2390	660.400 26.0000	206.375 8.1250	158.750 6.2500	4130000 928000	0.31	2.20	3.27	614000 138000	323000 72600	1070000 240000	1.90
488.671 19.2390	666.674 26.2470	206.375 8.1250	158.750 6.2500	4130000 928000	0.31	2.20	3.27	614000 138000	323000 72600	1070000 240000	1.90
488.950 19.2500	634.873 24.9950	180.975 7.1250	136.525 5.3750	3240000 728000	0.47	1.43	2.12	482000 108000	390000 87800	840000 189000	1.24
488.950 19.2500	660.400 26.0000	206.375 8.1250	158.750 6.2500	4130000 928000	0.31	2.20	3.27	614000 138000	323000 72600	1070000 240000	1.90
488.950 19.2500	660.400 26.0000	206.375 8.1250	158.750 6.2500	4130000 928000	0.31	2.20	3.27	614000 138000	323000 72600	1070000 240000	1.90
488.950 19.2500	660.400 26.0000	206.375 8.1250	158.750 6.2500	4130000 928000	0.31	2.20	3.27	614000 138000	323000 72600	1070000 240000	1.90
488.950 19.2500	666.674 26.2470	206.375 8.1250	158.750 6.2500	4130000 928000	0.31	2.20	3.27	614000 138000	323000 72600	1070000 240000	1.90
489.026 19.2530	634.873 24.9950	177.800 7.0000	142.875 5.6250	2560000 574000	0.34	1.97	2.93	380000 85500	223000 50200	662000 149000	1.70
489.026 19.2530	634.873 24.9950	177.800 7.0000	142.875 5.6250	2560000 574000	0.34	1.97	2.93	380000 85500	223000 50200	662000 149000	1.70
498.475 19.6250	634.873 24.9950	177.800 7.0000	142.875 5.6250	2560000 574000	0.34	1.97	2.93	380000 85500	223000 50200	662000 149000	1.70
498.475 19.6250	634.873 24.9950	177.800 7.0000	142.875 5.6250	2560000 574000	0.34	1.97	2.93	380000 85500	223000 50200	662000 149000	1.70
501.650 19.7500	711.200 28.0000	292.100 11.5000	231.775 9.1250	6150000 1380000	0.33	2.03	3.02	916000 206000	521000 117000	1590000 358000	1.76
508.000 20.0000	736.600 29.0000	186.502 7.3426	114.300 4.5000	3460000 778000	0.47	1.42	2.12	516000 116000	418000 94000	898000 202000	1.23
508.000 20.0000	838.200 33.0000	304.800 12.0000	222.250 8.7500	6290000 1410000	0.48	1.41	2.10	936000 210000	769000 173000	1630000 366000	1.22
514.350 20.2500	736.600 29.0000	186.502 7.3426	114.300 4.5000	3460000 778000	0.47	1.42	2.12	516000 116000	418000 94000	898000 202000	1.23
520.700 20.5000	736.600 29.0000	186.502 7.3426	114.300 4.5000	3460000 778000	0.47	1.42	2.12	516000 116000	418000 94000	898000 202000	1.23

<sup>(1)</sup>Based on 1 x 10<sup>6</sup> revolutions L<sub>10</sub> life, for the ISO life-calculation method. C<sub>1(2)</sub> is the double-row radial value.

<sup>(2)</sup>Consult your Timken engineer for instructions on use or review the Timken Engineering Manual on [timken.com/catalogs](http://timken.com/catalogs).

<sup>(3)</sup>Based on 90 x 10<sup>6</sup> revolutions L<sub>10</sub> life, for The Timken Company life-calculation method. C<sub>90</sub> and C<sub>a90</sub> are radial and thrust values for a single row. C<sub>90(2)</sub> is the double-row radial value.



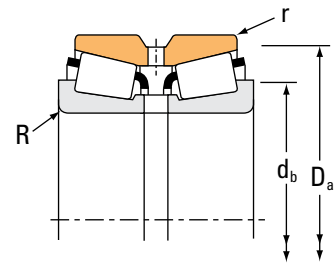
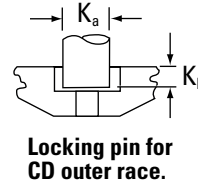
Part Number		Dimensions						Geometry Factors			Bearing Weight
Inner	Outer	Shaft		Housing		Pin		G <sub>1</sub>	G <sub>2</sub>	C <sub>g</sub>	
		Max. Shaft Fillet Radius R <sup>(4)</sup>	Backing Shoulder Dia. d <sub>b</sub>	Max. Housing Fillet Radius r <sup>(4)</sup>	Backing Shoulder Dia. D <sub>a</sub>	K <sub>a</sub>	K <sub>b</sub>				
		mm in.	mm in.	mm in.	mm in.	mm in.	mm in.				kg lbs.
EE243190	243251D	6.4 0.25	516.0 20.31	1.5 0.06	609.0 24.00	– –	– –	6057.3	726.6	0.2350	141.71 312.43
EE640191	640261CD	6.4 0.25	522.0 20.55	1.5 0.06	630.4 24.82	28.58 1.13	15.87 0.63	6322.4	601.7	0.2310	186.18 410.43
EE640191	640262D	6.4 0.25	522.0 20.55	1.5 0.06	630.5 24.82	– –	– –	6322.4	601.7	0.2310	199.52 439.85
LM772748	LM772710CD	6.4 0.25	522.0 20.55	1.5 0.06	613.5 24.15	28.58 1.13	14.30 0.56	5447.5	602.2	0.2525	134.50 296.54
EE640192	640261CD	6.4 0.25	522.0 20.55	1.5 0.06	630.4 24.82	28.58 1.13	15.87 0.63	6322.4	601.7	0.2310	185.88 409.74
EE640192	640261XD	6.4 0.25	522.0 20.55	1.5 0.06	630.5 24.82	– –	– –	6322.4	601.7	0.2310	185.45 408.79
EE640192	640261CD	6.4 0.25	522.0 20.55	1.5 0.06	630.5 24.82	28.58 1.13	15.87 0.63	6322.4	601.7	0.2310	185.45 408.79
EE640192	640262D	6.4 0.25	522.0 20.55	1.5 0.06	630.5 24.82	– –	– –	6322.4	601.7	0.2310	199.22 439.15
EE243192	243251D	6.4 0.25	522.0 20.55	1.5 0.06	609.0 24.00	– –	– –	6057.3	726.6	0.2350	138.36 305.01
EE243192	243251CD	6.4 0.25	522.0 20.55	1.5 0.06	609.0 24.00	28.58 1.13	13.48 0.53	6057.3	726.6	0.2350	138.36 305.01
EE243196	243251D	6.4 0.25	528.0 20.79	1.5 0.06	609.0 24.00	– –	– –	6057.3	726.6	0.2350	129.16 284.77
EE243196	243251CD	6.4 0.25	528.0 20.79	1.5 0.06	609.0 24.00	28.58 1.13	13.48 0.53	6057.3	726.6	0.2350	129.16 284.77
M274149	M274110CD	6.4 0.25	540.0 21.26	1.5 0.06	678.0 26.69	33.35 1.31	16.99 0.67	9019.6	560.7	0.2690	354.07 780.61
EE982003	982901CD	6.4 0.25	549.0 21.61	1.5 0.06	684.0 26.93	25.40 1.00	15.87 0.63	4901.2	606.3	0.2429	227.52 501.59
EE426200	426331CD	9.7 0.38	564.0 22.20	3.3 0.13	767.7 30.23	38.10 1.50	20.65 0.81	6651.9	435.2	0.2722	601.74 1326.62
EE982028	982901CD	6.4 0.25	555.0 21.85	1.5 0.06	684.0 26.93	25.40 1.00	15.87 0.63	4901.2	606.3	0.2429	220.08 485.17
EE982051	982901CD	6.4 0.25	558.0 21.97	1.5 0.06	684.0 26.93	25.40 1.00	15.87 0.63	4901.2	606.3	0.2429	212.53 468.55

<sup>(4)</sup>These maximum fillet radii will be cleared by bearing corners.  
NOTE: For spacer configuration information, contact your Timken engineer.

# TAPERED ROLLER BEARINGS

## DOUBLE-ROW • TYPE TDO

### TYPE TDO



Bearing Dimensions				Load Ratings							
Bore d	O.D. D	Width T	Double Outer Ring Width C	Dynamic <sup>(1)</sup>				Dynamic <sup>(3)</sup>			
				C <sub>1(2)</sub>	e	Y <sub>1</sub>	Y <sub>2</sub>	C <sub>90</sub>	C <sub>a90</sub>	C <sub>90(2)</sub>	K
mm in.	mm in.	mm in.	mm in.	N lbf				N lbf	N lbf	N lbf	
533.400 21.0000	784.225 30.8750	190.500 7.5000	120.650 4.7500	3770000 848000	0.48	1.42	2.11	561000 126000	457000 103000	977000 220000	1.23
533.400 21.0000	812.800 32.0000	269.875 10.6250	187.325 7.3750	5200000 1170000	0.44	1.52	2.26	774000 174000	588000 132000	1350000 303000	1.32
533.400 21.0000	812.800 32.0000	269.875 10.6250	187.325 7.3750	5200000 1170000	0.44	1.52	2.26	774000 174000	588000 132000	1350000 303000	1.32
534.988 21.0625	622.300 24.5000	101.600 4.0000	73.025 2.8750	1160000 261000	0.37	1.83	2.73	173000 38900	109000 24500	301000 67700	1.59
534.988 21.0625	622.300 24.5000	111.125 4.3750	82.550 3.2500	1160000 261000	0.37	1.83	2.73	173000 38900	109000 24500	301000 67700	1.59
536.575 21.1250	761.873 29.9950	311.150 12.2500	247.650 9.7500	6980000 1570000	0.33	2.03	3.02	1040000 234000	592000 133000	1810000 407000	1.76
546.100 21.5000	736.600 29.0000	165.100 6.5000	114.300 4.5000	2440000 548000	0.51	1.33	1.98	363000 81600	316000 71000	632000 142000	1.15
549.275 21.6250	692.150 27.2500	174.625 6.8750	136.525 5.3750	2650000 595000	0.38	1.79	2.67	394000 88500	254000 57000	686000 154000	1.55
558.800 22.0000	736.600 29.0000	165.100 6.5000	114.300 4.5000	2440000 548000	0.51	1.33	1.98	363000 81600	316000 71000	632000 142000	1.15
558.800 22.0000	736.600 29.0000	187.328 7.3751	138.112 5.4375	3600000 810000	0.34	1.97	2.93	536000 121000	315000 70700	934000 210000	1.70
558.800 22.0000	736.600 29.0000	225.425 8.8750	177.800 7.0000	5130000 1150000	0.35	1.95	2.90	765000 172000	453000 102000	1330000 299000	1.69
558.800 22.0000	736.600 29.0000	225.425 8.8750	177.800 7.0000	4480000 1010000	0.35	1.95	2.90	667000 150000	395000 88800	1160000 261000	1.69
558.800 22.0000	742.950 29.2500	187.328 7.3751	138.112 5.4375	3600000 810000	0.34	1.97	2.93	536000 121000	315000 70700	934000 210000	1.70
558.800 22.0000	901.700 35.5000	292.100 11.5000	212.725 8.3750	6610000 1480000	0.41	1.65	2.46	984000 221000	687000 154000	1710000 385000	1.43
560.000 22.0472	820.000 32.2835	258.500 10.1772	185.000 7.2835	5250000 1180000	0.46	1.48	2.20	781000 176000	611000 137000	1360000 306000	1.28
560.000 22.0472	820.000 32.2835	268.000 10.5512	190.000 7.4803	5250000 1180000	0.46	1.48	2.20	781000 176000	611000 137000	1360000 306000	1.28
565.150 22.2500	863.600 34.0000	317.500 12.5000	228.600 9.0000	6960000 1570000	0.34	1.96	2.93	1040000 233000	610000 137000	1810000 406000	1.70

<sup>(1)</sup>Based on 1 x 10<sup>6</sup> revolutions L<sub>10</sub> life, for the ISO life-calculation method. C<sub>1(2)</sub> is the double-row radial value.

<sup>(2)</sup>Consult your Timken engineer for instructions on use or review the Timken Engineering Manual on [timken.com/catalogs](http://timken.com/catalogs).

<sup>(3)</sup>Based on 90 x 10<sup>6</sup> revolutions L<sub>10</sub> life, for The Timken Company life-calculation method. C<sub>90</sub> and C<sub>a90</sub> are radial and thrust values for a single row. C<sub>90(2)</sub> is the double-row radial value.

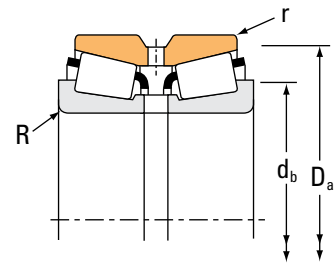
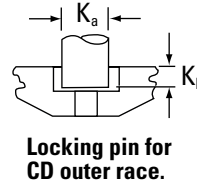
Part Number		Dimensions						Geometry Factors			Bearing Weight
Inner	Outer	Shaft		Housing		Pin		G <sub>1</sub>	G <sub>2</sub>	C <sub>G</sub>	
		Max. Shaft Fillet Radius R <sup>(4)</sup>	Backing Shoulder Dia. d <sub>b</sub>	Max. Housing Fillet Radius r <sup>(4)</sup>	Backing Shoulder Dia. D <sub>a</sub>	K <sub>a</sub>	K <sub>b</sub>				
		mm in.	mm in.	mm in.	mm in.	mm in.	mm in.				kg lbs.
EE522102	523088D	6.4 0.25	576.0 22.68	1.5 0.06	733.8 28.89	– –	– –	5013.3	457.2	0.2452	263.14 580.10
EE626210	626321D	9.7 0.38	585.0 23.03	3.3 0.13	762.5 30.02	– –	– –	6364.0	563.1	0.2608	448.08 987.81
EE626210	626321CD	9.7 0.38	585.0 23.03	3.3 0.13	762.5 30.02	30.18 1.19	18.31 0.72	6364.0	563.1	0.2608	448.08 987.81
LL475048	LL475010D	3.5 0.14	552.0 21.73	1.5 0.06	609.0 23.98	– –	– –	4586.9	1294.0	0.2160	44.63 98.34
LL475048	LL475011D	3.5 0.14	552.0 21.73	1.5 0.06	609.0 23.98	– –	– –	4586.9	1294.0	0.2160	47.73 105.17
M276449	M276410CD	6.4 0.25	576.0 22.68	1.5 0.06	725.6 28.57	38.10 1.50	19.05 0.75	10625.0	614.5	0.2839	435.41 959.92
EE542215	542291CD	6.4 0.25	585.0 23.03	3.3 0.13	705.1 27.76	25.40 1.00	13.48 0.53	5727.7	782.5	0.2604	178.78 394.13
L476549	L476510CD	6.4 0.25	579.0 22.80	1.5 0.06	666.0 26.22	28.58 1.13	14.30 0.56	7261.6	889.8	0.2567	142.05 313.17
EE542220	542291CD	6.4 0.25	594.0 23.39	3.3 0.13	705.1 27.76	25.40 1.00	13.48 0.53	5727.7	782.5	0.2604	165.28 364.38
EE843220	843291CD	6.4 0.25	591.0 23.27	1.5 0.06	708.0 27.87	28.58 1.13	15.09 0.59	7097.5	714.8	0.2478	196.10 432.32
LM377448	LM377410CD	6.4 0.25	594.0 23.39	1.5 0.06	708.0 27.87	28.58 1.13	16.69 0.66	9314.8	907.6	0.2735	246.15 542.65
LM377449	LM377410CD	6.4 0.25	594.0 23.39	1.5 0.06	708.0 27.87	28.58 1.13	16.69 0.66	9314.8	907.6	0.2735	246.52 543.45
EE843220	843292D	6.4 0.25	591.0 23.27	1.5 0.06	707.1 27.84	– –	– –	7097.5	714.8	0.2478	204.62 451.10
EE327220	327357D	12.7 0.50	624.0 24.57	3.3 0.13	836.2 32.92	– –	– –	7790.8	478.4	0.2715	656.31 1447.54
NP915736	NP585761	8.0 0.31	606.0 23.86	3.5 0.14	783.0 30.83	28.58 1.13	17.37 0.68	6738.0	546.6	0.2682	406.98 897.06
NP934748	NP920752	10.0 0.39	606.0 23.86	3.5 0.14	783.0 30.83	28.58 1.13	17.37 0.68	6738.0	546.6	0.2682	412.68 909.79
EE929225	929341D	8.0 0.31	614.9 24.21	3.3 0.13	809.5 31.87	– –	– –	9118.4	670.2	0.2711	610.33 1345.54

<sup>(4)</sup>These maximum fillet radii will be cleared by bearing corners.  
NOTE: For spacer configuration information, contact your Timken engineer.

# TAPERED ROLLER BEARINGS

## DOUBLE-ROW • TYPE TDO

### TYPE TDO



Bearing Dimensions				Load Ratings							
Bore d	O.D. D	Width T	Double Outer Ring Width C	Dynamic <sup>(1)</sup>				Dynamic <sup>(3)</sup>			
				C <sub>1(2)</sub>	e	Y <sub>1</sub>	Y <sub>2</sub>	C <sub>90</sub>	C <sub>a90</sub>	C <sub>90(2)</sub>	K
mm in.	mm in.	mm in.	mm in.	N lbf				N lbf	N lbf	N lbf	
571.500 22.5000	812.800 32.0000	333.375 13.1250	263.525 10.3750	7890000 1770000	0.33	2.03	3.02	1180000 264000	669000 150000	2050000 460000	1.76
584.200 23.0000	762.000 30.0000	228.600 9.0000	169.862 6.6875	4220000 949000	0.47	1.43	2.12	628000 141000	509000 114000	1090000 246000	1.24
584.200 23.0000	901.700 35.5000	298.453 11.7501	214.312 8.4375	8670000 1950000	0.33	2.04	3.03	1290000 290000	732000 165000	2250000 505000	1.76
584.200 23.0000	901.700 35.5000	298.453 11.7501	214.312 8.4375	8670000 1950000	0.33	2.04	3.03	1290000 290000	732000 165000	2250000 505000	1.76
585.788 23.0625	771.525 30.3750	269.047 10.5924	212.725 8.3750	5730000 1290000	0.33	2.03	3.02	853000 192000	486000 109000	1490000 334000	1.76
602.945 23.7380	787.400 31.0000	206.375 8.1250	158.750 6.2500	3790000 852000	0.37	1.82	2.71	565000 127000	358000 80600	983000 221000	1.58
602.945 23.7380	787.400 31.0000	206.375 8.1250	158.750 6.2500	4550000 1020000	0.37	1.82	2.71	677000 152000	430000 96600	1180000 265000	1.58
602.945 23.7380	793.750 31.2500	206.375 8.1250	158.750 6.2500	4550000 1020000	0.37	1.82	2.71	677000 152000	430000 96600	1180000 265000	1.58
607.720 23.9260	787.400 31.0000	206.375 8.1250	158.750 6.2500	4550000 1020000	0.37	1.82	2.71	677000 152000	430000 96600	1180000 265000	1.58
607.720 23.9260	793.750 31.2500	206.375 8.1250	158.750 6.2500	4550000 1020000	0.37	1.82	2.71	677000 152000	430000 96600	1180000 265000	1.58
609.600 24.0000	717.550 28.2500	127.000 5.0000	95.250 3.7500	1640000 369000	0.40	1.68	2.50	244000 54900	168000 37800	425000 95600	1.45
609.600 24.0000	787.400 31.0000	206.375 8.1250	158.750 6.2500	4550000 1020000	0.37	1.82	2.71	677000 152000	430000 96600	1180000 265000	1.58
609.600 24.0000	787.400 31.0000	206.375 8.1250	158.750 6.2500	4420000 993000	0.37	1.82	2.71	657000 148000	417000 93800	1140000 257000	1.58
609.600 24.0000	793.750 31.2500	206.375 8.1250	158.750 6.2500	4550000 1020000	0.37	1.82	2.71	677000 152000	430000 96600	1180000 265000	1.58
609.600 24.0000	812.800 32.0000	190.500 7.5000	146.050 5.7500	3610000 812000	0.33	2.05	3.05	538000 121000	303000 68200	937000 211000	1.77
635.000 25.0000	933.450 36.7500	377.825 14.8750	301.625 11.8750	10200000 2290000	0.33	2.03	3.02	1520000 342000	865000 195000	2650000 595000	1.76
635.000 25.0000	990.600 39.0000	339.725 13.3750	212.725 8.3750	9370000 2110000	0.87	0.78	1.16	1390000 314000	2070000 465000	2430000 546000	0.67

<sup>(1)</sup>Based on 1 x 10<sup>6</sup> revolutions L<sub>10</sub> life, for the ISO life-calculation method. C<sub>1(2)</sub> is the double-row radial value.

<sup>(2)</sup>Consult your Timken engineer for instructions on use or review the Timken Engineering Manual on [timken.com/catalogs](http://timken.com/catalogs).

<sup>(3)</sup>Based on 90 x 10<sup>6</sup> revolutions L<sub>10</sub> life, for The Timken Company life-calculation method. C<sub>90</sub> and C<sub>a90</sub> are radial and thrust values for a single row. C<sub>90(2)</sub> is the double-row radial value.

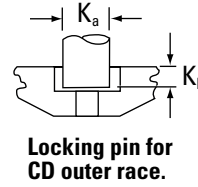
Part Number		Dimensions						Geometry Factors			Bearing Weight
Inner	Outer	Shaft		Housing		Pin		G <sub>1</sub>	G <sub>2</sub>	C <sub>G</sub>	
		Max. Shaft Fillet Radius R <sup>(4)</sup>	Backing Shoulder Dia. d <sub>b</sub>	Max. Housing Fillet Radius r <sup>(4)</sup>	Backing Shoulder Dia. D <sub>a</sub>	K <sub>a</sub>	K <sub>b</sub>				
		mm in.	mm in.	mm in.	mm in.	mm in.	mm in.				kg lbs.
M278749	M278710CD	6.4 0.25	615.0 24.21	1.5 0.06	774.0 30.47	28.58 1.13	17.47 0.69	12425.1	669.4	0.2990	533.70 1176.59
LM778549	LM778510D	6.4 0.25	621.0 24.45	1.5 0.06	736.9 29.01	– –	– –	8573.3	722.5	0.2936	245.35 540.90
EE662303	663551CD	8.0 0.31	633.0 24.92	1.5 0.06	848.1 33.39	36.50 1.44	20.65 0.81	8756.7	477.1	0.2638	613.42 1352.38
EE662303	663551D	8.0 0.31	633.0 24.92	1.5 0.06	848.1 33.39	– –	– –	8756.7	477.1	0.2638	612.14 1349.57
LM278849	LM278810CD	6.4 0.25	621.0 24.45	1.5 0.06	744.0 29.29	36.50 1.44	17.47 0.69	11553.5	930.7	0.2906	323.60 713.42
EE649236X	649311CD	6.4 0.25	642.0 25.28	1.5 0.06	755.3 29.74	28.58 1.13	15.87 0.63	8978.8	1193.1	0.2746	243.77 537.43
EE649237	649311CD	6.4 0.25	639.0 25.16	1.5 0.06	755.3 29.74	28.58 1.13	15.87 0.63	9384.8	930.0	0.2790	247.25 545.03
EE649237	649313D	6.4 0.25	639.0 25.16	1.5 0.06	755.3 29.74	– –	– –	9384.8	930.0	0.2790	257.07 566.69
EE649239	649311CD	6.4 0.25	642.0 25.28	1.5 0.06	755.3 29.74	28.58 1.13	15.87 0.63	9384.8	930.0	0.2790	239.77 528.56
EE649239	649313D	6.4 0.25	642.0 25.28	1.5 0.06	755.3 29.74	– –	– –	9384.8	930.0	0.2790	249.59 550.21
LL579749	LL579710D	6.4 0.25	636.0 25.04	1.5 0.06	702.0 27.64	– –	– –	6863.4	1515.1	0.2544	81.33 179.29
EE649240	649311CD	6.4 0.25	642.0 25.28	1.5 0.06	755.3 29.74	28.58 1.13	15.87 0.63	9384.8	930.0	0.2790	236.28 520.87
EE649240H	649311CD	6.4 0.25	642.0 25.28	1.5 0.06	755.3 29.74	28.58 1.13	15.87 0.63	9115.2	904.3	0.2761	226.86 500.18
EE649240	649313D	6.4 0.25	642.0 25.28	1.5 0.06	755.3 29.74	– –	– –	9384.8	930.0	0.2790	241.96 533.40
EE743240	743321CD	6.4 0.25	645.0 25.39	3.3 0.13	765.1 30.12	28.58 1.13	17.47 0.69	7714.7	995.4	0.2499	243.11 535.98
M281635	M281610CD	12.0 0.47	699.0 27.52	1.5 0.06	890.0 35.04	38.10 1.50	21.43 0.84	17304.9	775.6	0.3335	865.96 1909.10
NP830348	NP547476	6.4 0.25	714.0 28.11	3.3 0.13	939.0 36.97	28.58 1.13	19.83 0.78	9855.8	434.7	0.3688	881.72 1943.87

<sup>(4)</sup>These maximum fillet radii will be cleared by bearing corners.  
NOTE: For spacer configuration information, contact your Timken engineer.

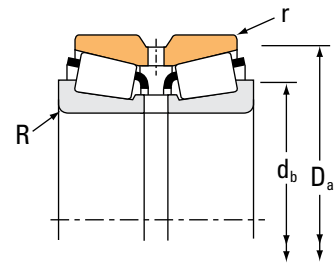
# TAPERED ROLLER BEARINGS

## DOUBLE-ROW • TYPE TDO

### TYPE TDO



Locking pin for CD outer race.



Bearing Dimensions				Load Ratings							
Bore d	O.D. D	Width T	Double Outer Ring Width C	Dynamic <sup>(1)</sup>				Dynamic <sup>(3)</sup>			
				C <sub>1(2)</sub>	e	Y <sub>1</sub>	Y <sub>2</sub>	C <sub>90</sub>	C <sub>a90</sub>	C <sub>90(2)</sub>	K
mm in.	mm in.	mm in.	mm in.	N lbf				N lbf	N lbf	N lbf	
646.112 25.4375	857.250 33.7500	304.800 12.0000	241.300 9.5000	8180000 1840000	0.33	2.03	3.02	1220000 274000	694000 156000	2120000 477000	1.76
660.400 26.0000	812.800 32.0000	203.200 8.0000	158.750 6.2500	4760000 1070000	0.33	2.03	3.02	709000 159000	404000 90700	1230000 278000	1.76
660.400 26.0000	812.800 32.0000	203.200 8.0000	158.750 6.2500	4410000 992000	0.33	2.03	3.02	657000 148000	374000 84100	1140000 257000	1.76
660.400 26.0000	854.923 33.6584	186.329 7.3358	135.900 5.3504	3900000 877000	0.35	1.92	2.86	581000 131000	349000 78600	1010000 227000	1.66
679.450 26.7500	901.700 35.5000	307.975 12.1250	244.475 9.6250	8740000 1960000	0.33	2.03	3.02	1300000 292000	741000 166000	2260000 509000	1.76
682.625 26.8750	965.200 38.0000	396.875 15.6250	311.150 12.2500	10900000 2440000	0.33	2.03	3.02	1620000 364000	921000 207000	2820000 634000	1.76
685.800 27.0000	876.300 34.5000	200.025 7.8750	152.400 6.0000	4790000 1080000	0.42	1.62	2.42	714000 160000	508000 114000	1240000 279000	1.40
710.000 27.9528	899.925 35.4301	230.000 9.0551	166.002 6.5355	4990000 1120000	0.52	1.29	1.92	743000 167000	667000 150000	1290000 291000	1.11
711.200 28.0000	914.400 36.0000	190.500 7.5000	139.700 5.5000	4150000 934000	0.38	1.77	2.64	619000 139000	403000 90600	1080000 242000	1.54
719.930 28.3437	914.905 36.0199	189.240 7.4504	139.903 5.5080	4150000 934000	0.38	1.77	2.64	619000 139000	403000 90600	1080000 242000	1.54
723.900 28.5000	914.400 36.0000	187.325 7.3750	139.700 5.5000	4150000 934000	0.38	1.77	2.64	619000 139000	403000 90600	1080000 242000	1.54
723.900 28.5000	1003.300 39.5000	187.325 7.3750	139.700 5.5000	4150000 934000	0.38	1.77	2.64	619000 139000	403000 90600	1080000 242000	1.54
749.300 29.5000	965.200 38.0000	187.325 7.3750	133.350 5.2500	4270000 961000	0.40	1.68	2.50	636000 143000	438000 98400	1110000 249000	1.45
749.300 29.5000	990.600 39.0000	338.000 13.3071	265.000 10.4331	10400000 2340000	0.33	2.03	3.02	1550000 349000	883000 198000	2700000 607000	1.76
762.000 30.0000	965.200 38.0000	187.325 7.3750	133.350 5.2500	4270000 961000	0.40	1.68	2.50	636000 143000	438000 98400	1110000 249000	1.45
774.700 30.5000	965.200 38.0000	187.325 7.3750	133.350 5.2500	4270000 961000	0.40	1.68	2.50	636000 143000	438000 98400	1110000 249000	1.45
774.700 30.5000	965.200 38.0000	187.325 7.3750	133.350 5.2500	4270000 961000	0.40	1.68	2.50	636000 143000	438000 98400	1110000 249000	1.45

<sup>(1)</sup>Based on 1 x 10<sup>6</sup> revolutions L<sub>10</sub> life, for the ISO life-calculation method. C<sub>1(2)</sub> is the double-row radial value.

<sup>(2)</sup>Consult your Timken engineer for instructions on use or review the Timken Engineering Manual on [timken.com/catalogs](http://timken.com/catalogs).

<sup>(3)</sup>Based on 90 x 10<sup>6</sup> revolutions L<sub>10</sub> life, for The Timken Company life-calculation method. C<sub>90</sub> and C<sub>a90</sub> are radial and thrust values for a single row. C<sub>90(2)</sub> is the double-row radial value.

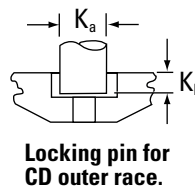
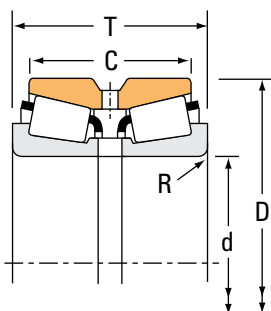
Part Number		Dimensions						Geometry Factors			Bearing Weight
Inner	Outer	Shaft		Housing		Pin		G <sub>1</sub>	G <sub>2</sub>	C <sub>g</sub>	
		Max. Shaft Fillet Radius R <sup>(4)</sup>	Backing Shoulder Dia. d <sub>b</sub>	Max. Housing Fillet Radius r <sup>(4)</sup>	Backing Shoulder Dia. D <sub>a</sub>	K <sub>a</sub>	K <sub>b</sub>				
		mm in.	mm in.	mm in.	mm in.	mm in.	mm in.				
LM281049	LM281010CD	6.4 0.25	684.0 26.93	1.5 0.06	824.5 32.46	28.58 1.13	18.26 0.72	14763.0	920.6	0.3153	460.91 1016.14
L281147	L281110CD	6.4 0.25	693.0 27.28	1.5 0.06	789.0 31.04	28.58 1.13	14.30 0.56	12635.6	984.9	0.2968	214.58 473.07
L281148	L281110CD	6.4 0.25	693.0 27.28	1.5 0.06	789.0 31.04	28.58 1.13	14.30 0.56	11705.7	915.8	0.2888	207.09 456.55
EE749260	749335CD	9.7 0.38	702.0 27.64	2.3 0.09	813.0 32.01	28.58 1.13	17.45 0.69	9222.1	1151.5	0.2707	241.40 532.16
LM281849	LM281810CD	9.7 0.38	726.0 28.58	1.5 0.06	866.6 34.12	39.70 1.56	22.22 0.88	16257.4	961.7	0.3252	513.79 1132.66
M282249	M282210CD	9.7 0.38	738.0 29.06	1.5 0.06	919.8 36.21	33.35 1.31	20.65 0.81	18773.0	843.1	0.3426	888.15 1958.07
EE655270	655346CD	6.4 0.25	723.0 28.46	1.5 0.06	841.4 33.13	28.58 1.13	17.47 0.69	11844.1	1202.6	0.3119	281.13 619.75
L882449	L882410CD	6.4 0.25	750.0 29.53	3.3 0.13	873.0 34.37	25.40 1.00	18.26 0.72	13015.8	1127.2	0.3473	331.66 731.22
EE755280	755361CD	6.4 0.25	750.0 29.53	3.3 0.13	877.0 34.53	28.58 1.13	15.87 0.63	11122.5	1282.2	0.2952	293.06 646.07
EE755282	755358XD	4.8 0.19	753.0 29.65	1.5 0.06	876.6 34.51	– –	– –	11122.5	1282.2	0.2952	277.57 611.93
EE755285	755361CD	5.5 0.22	756.0 29.76	3.3 0.13	877.0 34.53	28.58 1.13	15.87 0.63	11122.5	1282.2	0.2952	269.79 594.79
EE755285	755367CD	5.5 0.22	756.0 29.76	3.3 0.13	912.0 35.91	28.58 1.13	19.86 0.78	11122.5	1282.2	0.2952	409.60 903.01
EE752295	752381D	6.4 0.25	789.0 31.06	1.5 0.06	923.5 36.36	– –	– –	12456.8	1880.8	0.3116	304.73 671.84
LM283649	LM283610CD	6.4 0.25	792.0 31.18	3.3 0.13	952.4 37.50	33.35 1.31	21.43 0.84	20904.8	1142.9	0.3534	680.96 1501.25
EE752300	752381D	6.4 0.25	798.0 31.42	1.5 0.06	923.5 36.36	– –	– –	12456.8	1880.8	0.3116	295.64 651.81
EE752305	752381D	6.4 0.25	810.0 31.89	1.5 0.06	923.5 36.36	– –	– –	12456.8	1880.8	0.3116	279.45 616.08
EE752305	752381CD	6.4 0.25	810.0 31.89	1.5 0.06	923.5 36.36	28.58 1.13	11.91 0.47	12456.8	1880.8	0.3116	279.45 616.08

<sup>(4)</sup>These maximum fillet radii will be cleared by bearing corners.  
NOTE: For spacer configuration information, contact your Timken engineer.

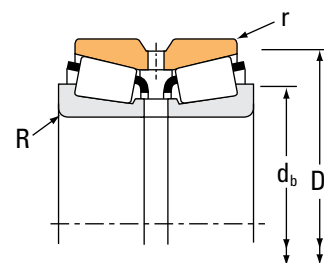
# TAPERED ROLLER BEARINGS

## TYPE TDO

### TYPE TDO



Locking pin for CD outer race.



Bearing Dimensions				Load Ratings							
Bore d	O.D. D	Width T	Double Outer Ring Width C	Dynamic <sup>(1)</sup>				Dynamic <sup>(3)</sup>			
				C <sub>1(2)</sub>	e	Y <sub>1</sub>	Y <sub>2</sub>	C <sub>90</sub>	C <sub>a90</sub>	C <sub>90(2)</sub>	K
mm in.	mm in.	mm in.	mm in.	N lbf				N lbf	N lbf	N lbf	
812.800 32.0000	1016.000 40.0000	190.500 7.5000	146.050 5.7500	4300000 968000	0.43	1.59	2.36	641000 144000	467000 105000	1120000 251000	1.37
812.800 32.0000	1066.800 42.0000	190.500 7.5000	146.050 5.7500	4300000 968000	0.43	1.59	2.36	641000 144000	467000 105000	1120000 251000	1.37
838.200 33.0000	1041.400 41.0000	190.500 7.5000	123.825 4.8750	4410000 991000	0.44	1.54	2.30	657000 148000	492000 111000	1140000 257000	1.33
850.000 33.4646	1120.000 44.0945	267.000 10.5118	190.000 7.4803	8520000 1920000	0.46	1.47	2.19	1270000 285000	996000 224000	2210000 497000	1.27
863.600 34.0000	1130.300 44.5000	371.475 14.6250	298.450 11.7500	11400000 2550000	0.33	2.03	3.02	1690000 380000	963000 216000	2940000 662000	1.76
863.600 34.0000	1371.600 54.0000	469.900 18.5000	285.750 11.2500	16500000 3710000	0.87	0.78	1.16	2460000 553000	3650000 820000	4280000 962000	0.67
914.400 36.0000	1066.800 42.0000	139.700 5.5000	101.600 4.0000	2820000 633000	0.41	1.65	2.45	420000 94300	294000 66100	731000 164000	1.43
938.212 36.9375	1270.000 50.0000	406.200 15.9921	266.500 10.4921	12600000 2820000	0.87	0.78	1.16	1870000 420000	2770000 623000	3250000 732000	0.67
977.900 38.5000	1130.300 44.5000	139.700 5.5000	101.600 4.0000	2910000 654000	0.44	1.55	2.30	433000 97300	323000 72700	754000 169000	1.34
1270.000 50.0000	1435.100 56.5000	146.050 5.7500	101.600 4.0000	3210000 721000	0.57	1.18	1.76	478000 107000	467000 105000	832000 187000	1.02
1395.603 54.9450	1697.038 66.8125	260.350 10.2500	190.500 7.5000	7550000 1700000	0.43	1.56	2.32	1120000 253000	835000 188000	1960000 440000	1.35
1397.000 55.0000	1697.038 66.8125	260.350 10.2500	190.500 7.5000	7550000 1700000	0.43	1.56	2.32	1120000 253000	835000 188000	1960000 440000	1.35
1397.000 55.0000	1697.038 66.8125	260.350 10.2500	190.500 7.5000	7550000 1700000	0.43	1.56	2.32	1120000 253000	835000 188000	1960000 440000	1.35
1784.350 70.2500	2006.600 79.0000	241.300 9.5000	177.800 7.0000	8410000 1890000	0.44	1.54	2.29	1250000 282000	943000 212000	2180000 490000	1.33
1828.800 72.0000	2006.600 79.0000	177.800 7.0000	123.825 4.8750	5080000 1140000	0.47	1.43	2.12	757000 170000	613000 138000	1320000 296000	1.23

<sup>(1)</sup>Based on  $1 \times 10^6$  revolutions  $L_{10}$  life, for the ISO life-calculation method.  $C_{1(2)}$  is the double-row radial value.

<sup>(2)</sup>Consult your Timken engineer for instructions on use or review the Timken Engineering Manual on [timken.com/catalogs](http://timken.com/catalogs).

<sup>(3)</sup>Based on  $90 \times 10^6$  revolutions  $L_{10}$  life, for The Timken Company life-calculation method.  $C_{90}$  and  $C_{a90}$  are radial and thrust values for a single row.  $C_{90(2)}$  is the double-row radial value.



Part Number		Dimensions						Geometry Factors			Bearing Weight
Inner	Outer	Shaft		Housing		Pin		G <sub>1</sub>	G <sub>2</sub>	C <sub>G</sub>	
		Max. Shaft Fillet Radius R <sup>(4)</sup>	Backing Shoulder Dia. d <sub>b</sub>	Max. Housing Fillet Radius r <sup>(4)</sup>	Backing Shoulder Dia. D <sub>a</sub>	K <sub>a</sub>	K <sub>b</sub>				
		mm in.	mm in.	mm in.	mm in.	mm in.	mm in.				kg lbs.
EE762320	762401D	6.4 0.25	849.0 33.43	1.5 0.06	976.6 38.45	– –	– –	13724.5	1634.7	0.3271	322.80 711.62
EE762320	762420XD	6.4 0.25	849.0 33.43	3.3 0.13	976.6 38.45	– –	– –	13724.5	1634.7	0.3271	427.99 943.52
EE763330	763410D	6.4 0.25	876.0 34.49	1.5 0.06	997.2 39.26	– –	– –	14677.1	1745.2	0.3374	323.40 712.98
NP442420	NP961009	8.0 0.32	900.0 35.43	3.5 0.14	1075.0 42.32	19.06 0.88	19.68 0.78	18466.6	1277.1	0.3733	660.60 1455.13
LM286249AA	LM286210CD	9.7 0.38	915.0 36.02	3.3 0.13	1090.4 42.93	38.10 1.50	24.61 0.97	28956.1	1086.1	0.3933	945.89 2085.33
LM986949	LM986910D	28.7 1.13	996.0 39.21	6.4 0.25	1290.0 50.79	– –	– –	20590.9	730.3	0.4700	2332.37 5142.00
LL686947	LL686910D	6.4 0.25	945.0 37.20	3.3 0.13	1037.2 40.83	– –	– –	16664.7	3390.4	0.3416	198.26 437.09
NP578395	NP508551	3.3 0.13	1005.0 39.57	3.3 0.13	1240.0 48.82	– –	– –	22762.7	983.1	0.4847	1361.12 3000.56
LL687949	LL687910D	6.4 0.25	1010.0 39.76	3.3 0.13	1100.0 43.32	– –	– –	18937.3	3190.6	0.3631	212.33 468.17
LL889049	LL889010D	6.4 0.25	1305.0 51.38	3.3 0.13	1405.0 55.31	– –	– –	31422.7	5654.9	0.4637	311.03 685.75
EE292548	292668D	6.0 0.24	1445.0 56.89	3.3 0.13	1619.6 63.76	– –	– –	58328.4	6111.6	0.5280	1061.43 2340.06
EE292550	292668D	6.0 0.24	1450.0 57.09	3.3 0.13	1619.6 63.76	– –	– –	58328.4	6111.6	0.5280	1055.81 2327.65
EE292550	292668CD	6.0 0.24	1450.0 57.09	3.3 0.13	1619.6 63.76	34.93 1.38	29.69 1.17	58328.4	6111.6	0.5280	1055.81 2327.65
LL789849	LL789810D	12.7 0.50	1840.0 72.44	3.3 0.13	1966.1 77.40	– –	– –	93391.2	10455.2	0.6160	978.66 2157.55
LL789949	LL789910XD	6.4 0.25	1865.0 73.43	3.3 0.13	1970.0 77.56	– –	– –	83190.9	15410.2	0.6006	589.45 1299.53

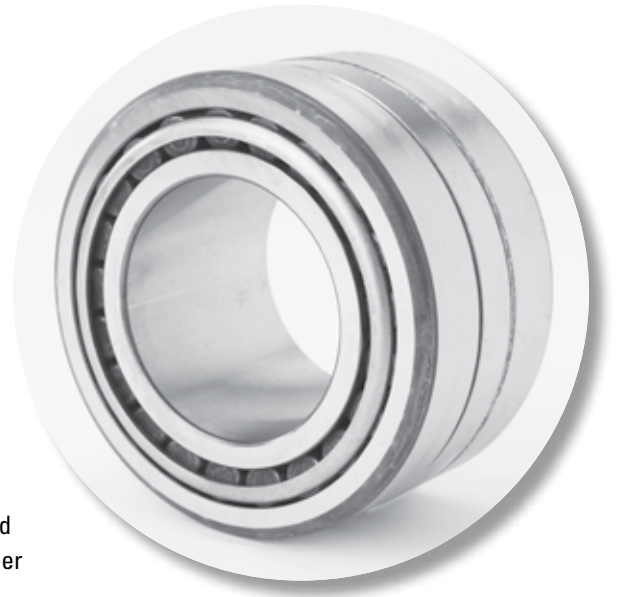
<sup>(4)</sup>These maximum fillet radii will be cleared by bearing corners.  
NOTE: For spacer configuration information, contact your Timken engineer.

**TAPERED ROLLER BEARINGS**

**DOUBLE-ROW • TYPE TDI • TYPE TDIT**

### ***TYPE TDI***

- TDI style consists of a single-piece (double) inner ring plus two single outer rings.
- It is normally supplied complete with an outer-ring spacer as a pre-set assembly.
- To suit the application duty, the built-in setting value needs to be established by your Timken engineer before an order is placed.
- A groove and holes can be supplied in the outer-ring spacer to allow lubricant to pass from the bearing housing. Contact your Timken engineer for spacer configuration information.
- Consult your Timken engineer before making a final bearing selection to help ensure suitability, availability and the most cost-effective solution.



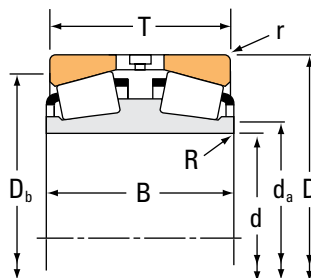
### ***TYPE TDIT***

- TDIT is a double inner-ring bearing with a tapered bore.
- It is comprised of a one-piece (double) inner ring and two single outer rings.
- TDIT bearings are typically supplied complete with an outer-ring spacer as a pre-set assembly. Contact your Timken engineer for spacer configuration information.
- These can be used in fixed (locating) positions on rotating-shaft applications.
- The tapered inner-ring bore allows for easy removal where interference fits are necessary and frequent removal of the bearing from the shaft is desired.
- Consult your Timken engineer before making a final bearing selection to help ensure suitability, availability and the most cost-effective solution.

# TAPERED ROLLER BEARINGS

## DOUBLE-ROW • TYPE TDI

### TYPE TDI



Bearing Dimensions				Load Ratings							
Bore d	O.D. D	Width T	Double Inner Ring Width B	Dynamic <sup>(1)</sup>				Dynamic <sup>(3)</sup>			
				C <sub>1(2)</sub>	e	Y <sub>1</sub>	Y <sub>2</sub>	C <sub>90</sub>	C <sub>a90</sub>	C <sub>90(2)</sub>	K
mm in.	mm in.	mm in.	mm in.	N lbf				N lbf	N lbf	N lbf	
31.750 1.2500	69.012 2.7170	39.705 1.5632	39.182 1.5426	95100 21400	0.4	1.8	2.6	14200 3180	9260 2080	24600 5540	1.53
42.862 1.6875	80.962 3.1875	34.925 1.3750	31.750 1.2500	88500 19900	0.5	1.3	1.9	13200 2960	11900 2680	22900 5160	1.11
44.450 1.7500	80.962 3.1875	34.925 1.3750	31.750 1.2500	88500 19900	0.5	1.3	1.9	13200 2960	11900 2680	22900 5160	1.11
46.037 1.8125	80.962 3.1875	34.925 1.3750	31.750 1.2500	88500 19900	0.5	1.3	1.9	13200 2960	11900 2680	22900 5160	1.11
50.800 2.0000	93.264 3.6718	50.013 1.9690	53.188 2.0940	153000 34400	0.3	2.0	3.0	22800 5120	13200 2970	39700 8920	1.73
50.800 2.0000	96.838 3.8125	53.188 2.0940	53.188 2.0940	153000 34400	0.3	2.0	3.0	22800 5120	13200 2970	39700 8920	1.73
55.562 2.1875	96.838 3.8125	51.298 2.0196	53.188 2.0940	158000 35600	0.4	1.9	2.8	23600 5300	14300 3210	41100 9230	1.65
63.500 2.5000	112.712 4.4375	60.325 2.3750	60.325 2.3750	291000 65300	0.3	2.0	3.0	43300 9730	25100 5650	75400 16900	1.72
63.500 2.5000	136.525 5.3750	66.091 2.6020	65.989 2.5980	298000 66900	0.9	0.8	1.2	44300 9970	65700 14800	77200 17400	0.67
63.500 2.5000	140.030 5.5130	66.090 2.6020	65.989 2.5980	298000 66900	0.9	0.8	1.2	44300 9970	65700 14800	77200 17400	0.67
64.987 2.5586	136.525 5.3750	66.091 2.6020	65.989 2.5980	298000 66900	0.9	0.8	1.2	44300 9970	65700 14800	77200 17400	0.67
64.987 2.5586	140.030 5.5130	66.091 2.6020	65.989 2.5980	298000 66900	0.9	0.8	1.2	44300 9970	65700 14800	77200 17400	0.67
80.962 3.1875	133.350 5.2500	60.325 2.3750	59.538 2.3440	269000 60500	0.4	1.5	2.3	40000 9000	30500 6850	69700 15700	1.31
80.962 3.1875	136.525 5.3750	60.325 2.3750	59.538 2.3440	269000 60500	0.4	1.5	2.3	40000 9000	30500 6850	69700 15700	1.31
80.962 3.1875	139.992 5.5115	80.962 3.1875	80.134 3.1549	360000 80900	0.4	1.7	2.5	53600 12100	37100 8330	93400 21000	1.45
85.725 3.3750	123.825 4.8750	41.278 1.6251	44.450 1.7500	161000 36300	0.3	2.1	3.1	24000 5400	13600 3050	41800 9400	1.77
85.725 3.3750	127.000 5.0000	41.278 1.6251	44.450 1.7500	161000 36300	0.3	2.1	3.1	24000 5400	13600 3050	41800 9400	1.77

<sup>(1)</sup>Based on 1 x 10<sup>6</sup> revolutions L<sub>10</sub> life, for the ISO life-calculation method. C<sub>1(2)</sub> is the double-row radial value.

<sup>(2)</sup>Consult your Timken engineer for instructions on use or review the Timken Engineering Manual on [timken.com/catalogs](http://timken.com/catalogs).

<sup>(3)</sup>Based on 90 x 10<sup>6</sup> revolutions L<sub>10</sub> life, for The Timken Company life-calculation method. C<sub>90</sub> and C<sub>a90</sub> are radial and thrust values for a single row. C<sub>90(2)</sub> is the double-row radial value.

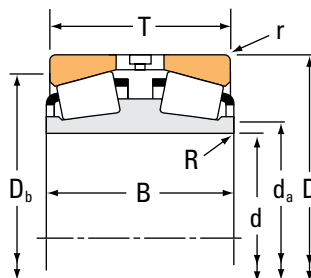
Part Number		Dimensions				Geometry Factors			Bearing Weight
Inner	Outer	Shaft		Housing		G <sub>1</sub>	G <sub>2</sub>	C <sub>g</sub>	
		Max Shaft Fillet Radius R <sup>(4)</sup>	Backing Shoulder Dia. d <sub>a</sub>	Max Housing Fillet Radius r <sup>(4)</sup>	Backing Shoulder Dia. D <sub>b</sub>				
		mm in.	mm in.	mm in.	mm in.				kg lbs.
14126D	14276	1.5 0.06	40.0 1.57	1.3 0.05	60.0 2.36	18.0	13.3	0.0668	0.71 1.57
13169D	13318	0.8 0.03	50.0 1.97	1.5 0.06	72.0 2.83	23.0	19.2	0.0799	0.77 1.71
13176D	13318	0.1 0.01	50.0 1.97	1.5 0.06	72.0 2.83	23.0	19.2	0.0799	0.74 1.65
13182D	13318	0.8 0.03	52.0 2.05	1.5 0.06	72.0 2.83	23.0	19.2	0.0799	0.73 1.62
375D	374	0.8 0.03	57.0 2.24	1.3 0.05	85.0 3.35	37.6	15.4	0.0816	1.40 3.09
375D	372A	0.8 0.03	57.0 2.24	1.5 0.06	86.0 3.39	37.6	15.4	0.0816	1.61 3.56
389DE	382A	0.8 0.03	63.0 2.48	0.8 0.03	89.0 3.50	42.0	15.7	0.0859	2.05 4.50
39585D	39520	0.8 0.03	72.0 2.83	3.3 0.13	101.0 3.98	84.3	23.7	0.1074	2.59 5.70
78251D	78537	2.3 0.09	79.0 3.11	3.3 0.13	115.0 4.53	62.6	19.1	0.0884	4.59 10.10
78251D	78551	2.3 0.09	79.0 3.11	2.3 0.09	117.0 4.61	62.6	19.1	0.0884	4.83 10.66
78255D	78537	1.5 0.06	79.0 3.11	3.3 0.13	115.0 4.53	62.6	19.1	0.0884	4.55 10.03
78255D	78551	1.5 0.06	79.0 3.11	2.3 0.09	117.0 4.61	62.6	19.1	0.0884	4.91 10.85
496D	492A	1.5 0.06	91.0 3.58	3.3 0.13	120.0 4.72	104.6	29.3	0.1252	3.25 7.16
496D	493	1.5 0.06	91.0 3.58	3.3 0.13	122.0 4.80	104.6	29.3	0.1252	3.53 7.77
581D	572	1.5 0.06	92.0 3.62	3.3 0.13	125.0 4.92	125.7	32.0	0.1295	5.31 11.71
L217845D	L217810	0.8 0.03	93.0 3.66	1.5 0.06	116.0 4.57	111.3	74.8	0.1152	1.74 3.80
L217845D	L217813	0.8 0.03	93.0 3.66	1.5 0.06	117.0 4.61	111.3	74.8	0.1152	1.93 4.23

<sup>(4)</sup>These maximum fillet radii will be cleared by bearing corners.  
NOTE: For spacer configuration information, contact your Timken engineer.

# TAPERED ROLLER BEARINGS

## DOUBLE-ROW • TYPE TDI

### TYPE TDI



Bearing Dimensions				Load Ratings							
Bore d	O.D. D	Width T	Double Inner Ring Width B	Dynamic <sup>(1)</sup>				Dynamic <sup>(3)</sup>			
				C <sub>1(2)</sub>	e	Factors <sup>(2)</sup> Y <sub>1</sub>	Y <sub>2</sub>	C <sub>90</sub>	C <sub>a90</sub>	C <sub>90(2)</sub>	Factors <sup>(2)</sup> K
mm in.	mm in.	mm in.	mm in.	N lbf				N lbf	N lbf	N lbf	
88.900 3.5000	161.925 6.3750	101.549 3.9980	107.950 4.2500	570000 128000	0.3	2.0	3.0	84800 19100	49500 11100	148000 33200	1.71
92.075 3.6250	148.430 5.8437	57.150 2.2500	57.942 2.2812	284000 63800	0.5	1.4	2.0	42200 9490	35600 8000	73500 16500	1.19
95.250 3.7500	136.525 5.3750	57.150 2.2500	57.150 2.2500	243000 54600	0.3	2.4	3.5	36200 8140	17600 3950	63000 14200	2.06
98.425 3.8750	180.975 7.1250	101.600 4.0000	102.362 4.0300	603000 135000	0.4	1.8	2.6	89700 20200	59200 13300	156000 35100	1.51
101.600 4.0000	157.162 6.1875	80.167 3.1562	79.375 3.1250	389000 87500	0.5	1.4	2.1	57900 13000	47100 10600	101000 22700	1.23
101.600 4.0000	161.925 6.3750	86.518 3.4062	79.375 3.1250	389000 87500	0.5	1.4	2.1	57900 13000	47100 10600	101000 22700	1.23
104.775 4.1250	180.975 7.1250	101.600 4.0000	102.362 4.0300	603000 135000	0.4	1.8	2.6	89700 20200	59200 13300	156000 35100	1.51
107.950 4.2500	212.725 8.3750	142.875 5.6250	152.400 6.0000	996000 224000	0.3	2.1	3.1	148000 33300	82700 18600	258000 58000	1.79
114.300 4.5000	190.500 7.5000	98.425 3.8750	101.600 4.0000	633000 142000	0.4	1.6	2.4	94300 21200	67100 15100	164000 36900	1.40
114.300 4.5000	212.725 8.3750	142.875 5.6250	152.400 6.0000	1180000 266000	0.3	2.1	3.1	176000 39600	98300 22100	307000 69000	1.79
120.650 4.7500	174.625 6.8750	66.678 2.6251	68.262 2.6875	426000 95700	0.3	2.0	3.0	63400 14200	36100 8110	110000 24800	1.76
127.000 5.0000	196.850 7.7500	92.075 3.6250	92.075 3.6250	640000 144000	0.3	2.0	2.9	95300 21400	56100 12600	166000 37300	1.70
127.000 5.0000	228.600 9.0000	160.338 6.3125	151.244 5.9545	655000 147000	0.7	0.9	1.4	97500 21900	123000 27600	170000 38200	0.79
127.000 5.0000	234.950 9.2500	139.700 5.5000	152.400 6.0000	1090000 246000	0.4	1.8	2.7	163000 36700	103000 23200	284000 63800	1.58
130.005 5.1183	215.900 8.5000	123.825 4.8750	123.825 4.8750	665000 150000	0.5	1.4	2.1	99000 22300	82600 18600	172000 38800	1.20
130.175 5.1250	215.900 8.5000	101.600 4.0000	101.600 4.0000	665000 150000	0.5	1.4	2.1	99000 22300	82600 18600	172000 38800	1.20
133.350 5.2500	196.850 7.7500	92.075 3.6250	92.075 3.6250	640000 144000	0.3	2.0	2.9	95300 21400	56100 12600	166000 37300	1.70

<sup>(1)</sup>Based on 1 x 10<sup>6</sup> revolutions L<sub>10</sub> life, for the ISO life-calculation method. C<sub>1(2)</sub> is the double-row radial value.

<sup>(2)</sup>Consult your Timken engineer for instructions on use or review the Timken Engineering Manual on [timken.com/catalogs](http://timken.com/catalogs).

<sup>(3)</sup>Based on 90 x 10<sup>6</sup> revolutions L<sub>10</sub> life, for The Timken Company life-calculation method. C<sub>90</sub> and C<sub>a90</sub> are radial and thrust values for a single row. C<sub>90(2)</sub> is the double-row radial value.

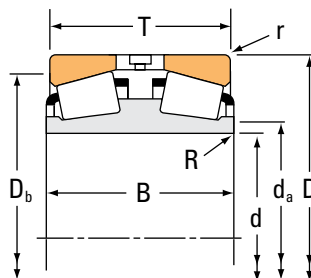
Part Number		Dimensions				Geometry Factors			Bearing Weight
Inner	Outer	Shaft		Housing		G <sub>1</sub>	G <sub>2</sub>	C <sub>g</sub>	
		Max Shaft Fillet Radius R <sup>(4)</sup>	Backing Shoulder Dia. d <sub>a</sub>	Max Housing Fillet Radius r <sup>(4)</sup>	Backing Shoulder Dia. D <sub>b</sub>				
		mm in.	mm in.	mm in.	mm in.				kg lbs.
767D	752	1.5 0.06	101.3 3.99	3.3 0.13	144.0 5.67	177.2	29.4	0.0945	8.77 19.33
42362D	42584	1.5 0.06	104.0 4.09	3.0 0.12	134.0 5.28	129.7	37.2	0.1386	3.87 8.53
LM119348D	LM119311	0.8 0.03	102.0 4.02	2.3 0.09	126.0 4.96	149.4	84.1	0.1213	2.68 5.91
779D	772	1.5 0.06	112.0 4.41	3.3 0.13	161.0 6.34	227.3	41.3	0.1067	11.33 24.99
52400D	52618	1.5 0.06	112.4 4.43	3.3 0.13	142.0 5.59	175.4	41.7	0.1519	5.29 11.67
52400D	52638	1.5 0.06	112.4 4.43	3.3 0.13	143.0 5.63	175.4	41.7	0.1519	6.28 13.83
782D	772	1.5 0.06	117.9 4.64	3.3 0.13	161.0 6.34	227.3	41.3	0.1067	10.68 23.57
946D	932	3.3 0.13	128.0 5.04	3.3 0.13	187.0 7.36	338.6	39.8	0.1153	22.94 50.60
71450D	71750	1.5 0.06	128.0 5.04	3.3 0.13	171.0 6.73	269.2	49.5	0.1156	11.01 24.27
HH224346DD	HH224310	3.3 0.13	133.2 5.24	3.3 0.13	192.0 7.56	366.6	47.9	0.1182	22.01 48.52
M224749D	M224710	0.8 0.03	129.0 5.08	1.5 0.06	162.0 6.38	279.1	86.6	0.1575	5.82 12.83
67388D	67322	1.5 0.06	140.0 5.51	3.3 0.13	180.0 7.09	383.7	70.1	0.1220	10.66 23.52
97500D	97900	1.5 0.06	144.0 5.67	3.3 0.13	197.0 7.76	237.1	44.6	0.1311	24.49 53.96
95499D	95925	5.0 0.20	152.0 5.98	3.3 0.13	209.0 8.23	453.9	59.4	0.1323	25.95 57.23
74510D	74850	1.5 0.06	146.0 5.75	3.3 0.13	196.0 7.72	362.9	68.5	0.1338	17.45 38.46
74512D	74850	1.5 0.06	146.0 5.75	3.3 0.13	196.0 7.72	362.9	68.5	0.1338	14.97 32.97
67390D	67322	1.5 0.06	145.0 5.71	3.3 0.13	180.0 7.09	383.7	70.1	0.1220	9.73 21.45

<sup>(4)</sup>These maximum fillet radii will be cleared by bearing corners.  
NOTE: For spacer configuration information, contact your Timken engineer.

# TAPERED ROLLER BEARINGS

## DOUBLE-ROW • TYPE TDI

### TYPE TDI



Bearing Dimensions				Load Ratings							
Bore d	O.D. D	Width T	Double Inner Ring Width B	Dynamic <sup>(1)</sup>				Dynamic <sup>(3)</sup>			
				C <sub>1(2)</sub>	e	Y <sub>1</sub>	Y <sub>2</sub>	C <sub>90</sub>	C <sub>a90</sub>	C <sub>90(2)</sub>	K
mm in.	mm in.	mm in.	mm in.	N lbf				N lbf	N lbf	N lbf	
136.525 5.3750	225.425 8.8750	120.650 4.7500	120.650 4.7500	1130000 253000	0.3	2.0	3.0	168000 37700	95500 21500	292000 65700	1.76
139.700 5.5000	200.025 7.8750	77.788 3.0625	75.408 2.9688	499000 112000	0.3	2.0	3.0	74300 16700	42800 9610	129000 29100	1.74
149.225 5.8750	236.538 9.3125	106.362 4.1875	105.346 4.1475	897000 202000	0.4	1.5	2.3	134000 30000	101000 22700	232000 52300	1.32
149.225 5.8750	241.300 9.5000	106.362 4.1875	105.346 4.1475	897000 202000	0.4	1.5	2.3	134000 30000	101000 22700	232000 52300	1.32
149.225 5.8750	254.000 10.0000	120.650 4.7500	120.650 4.7500	1150000 258000	0.4	1.7	2.5	171000 38500	119000 26800	298000 67000	1.43
152.400 6.0000	244.475 9.6250	87.312 3.4375	92.075 3.6250	699000 157000	0.4	1.9	2.9	104000 23400	62700 14100	181000 40800	1.66
155.575 6.1250	247.650 9.7500	122.238 4.8125	122.238 4.8125	1100000 248000	0.4	1.8	2.7	164000 36900	103000 23300	286000 64200	1.59
165.100 6.5000	225.425 8.8750	79.375 3.1250	76.200 3.0000	528000 119000	0.4	1.8	2.6	78600 17700	51600 11600	137000 30800	1.52
174.625 6.8750	288.925 11.3750	123.825 4.8750	123.825 4.8750	1430000 322000	0.3	2.1	3.2	214000 48000	117000 26200	372000 83600	1.83
177.800 7.0000	247.650 9.7500	90.488 3.5625	90.488 3.5625	705000 159000	0.4	1.5	2.3	105000 23600	79000 17800	183000 41100	1.33
177.800 7.0000	279.400 11.0000	112.710 4.4374	112.712 4.4375	930000 209000	0.5	1.3	1.9	138000 31100	124000 28000	241000 54200	1.11
177.800 7.0000	288.925 11.3750	123.825 4.8750	123.825 4.8750	1150000 258000	0.5	1.4	2.2	171000 38500	137000 30800	298000 67000	1.25
177.800 7.0000	288.925 11.3750	123.825 4.8750	123.825 4.8750	1430000 322000	0.3	2.1	3.2	214000 48000	117000 26200	372000 83600	1.83
177.800 7.0000	304.800 12.0000	109.438 4.3086	114.300 4.5000	1050000 236000	0.4	1.9	2.8	156000 35100	96400 21700	272000 61200	1.62
187.325 7.3750	319.964 12.5970	168.275 6.6250	161.925 6.3750	1830000 410000	0.3	2.1	3.2	272000 61100	148000 33400	473000 106000	1.83
187.325 7.3750	320.675 12.6250	168.275 6.6250	161.925 6.3750	1830000 410000	0.3	2.1	3.2	272000 61100	148000 33400	473000 106000	1.83
190.500 7.5000	317.500 12.5000	133.350 5.2500	133.350 5.2500	1270000 286000	0.5	1.3	1.9	190000 42600	170000 38200	330000 74200	1.12

<sup>(1)</sup>Based on 1 x 10<sup>6</sup> revolutions L<sub>10</sub> life, for the ISO life-calculation method. C<sub>1(2)</sub> is the double-row radial value.

<sup>(2)</sup>Consult your Timken engineer for instructions on use or review the Timken Engineering Manual on [timken.com/catalogs](http://timken.com/catalogs).

<sup>(3)</sup>Based on 90 x 10<sup>6</sup> revolutions L<sub>10</sub> life, for The Timken Company life-calculation method. C<sub>90</sub> and C<sub>a90</sub> are radial and thrust values for a single row. C<sub>90(2)</sub> is the double-row radial value.



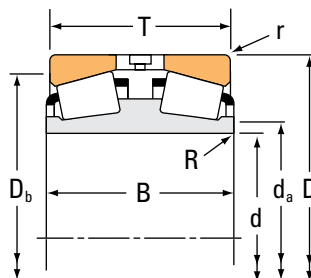
Part Number		Dimensions				Geometry Factors			Bearing Weight
Inner	Outer	Shaft		Housing		G <sub>1</sub>	G <sub>2</sub>	C <sub>g</sub>	
		Max Shaft Fillet Radius R <sup>(4)</sup>	Backing Shoulder Dia. d <sub>a</sub>	Max Housing Fillet Radius r <sup>(4)</sup>	Backing Shoulder Dia. D <sub>b</sub>				
		mm in.	mm in.	mm in.	mm in.				kg lbs.
H228649D	H228610	1.5 0.06	152.0 5.98	3.3 0.13	203.0 7.99	539.6	76.7	0.1358	19.97 44.03
48680D	48620	0.8 0.03	150.0 5.91	3.3 0.13	185.0 7.28	439.6	130.5	0.1261	8.13 17.90
82587D	82931	1.5 0.06	165.0 6.50	3.3 0.13	213.0 8.39	460.5	81.1	0.1405	17.47 38.50
82587D	82950	1.5 0.06	165.0 6.50	3.3 0.13	215.0 8.46	460.5	81.1	0.1405	19.08 42.07
99587D	99100	1.5 0.06	167.0 6.57	3.3 0.13	227.0 8.94	555.5	73.5	0.1459	25.95 57.18
81601D	81962	1.5 0.06	166.1 6.54	3.3 0.13	225.0 8.86	413.0	98.4	0.1250	14.96 32.96
H432549D	H432510	1.5 0.06	172.0 6.77	3.3 0.13	224.0 8.82	657.5	97.8	0.1178	23.18 51.14
46790D	46720	0.8 0.03	175.0 6.89	3.3 0.13	209.0 8.23	572.0	174.7	0.1432	9.45 20.84
HM237542D	HM237510	1.5 0.06	191.0 7.52	3.3 0.13	266.0 10.47	751.2	101.5	0.1168	31.85 70.23
67790D	67720	1.5 0.06	190.0 7.48	3.3 0.13	229.0 9.02	622.3	122.6	0.1214	13.30 29.34
82680D	82620	1.5 0.06	197.0 7.76	3.3 0.13	251.0 9.88	661.2	119.5	0.1313	25.80 56.88
94706D	94113	1.5 0.06	195.0 7.68	3.3 0.13	259.0 10.20	692.3	93.9	0.1287	32.59 71.85
HM237546D	HM237510	1.5 0.06	194.0 7.64	3.3 0.13	266.0 10.47	751.2	101.5	0.1168	31.80 70.13
EE280700D	281200	3.3 0.13	199.9 7.87	3.3 0.13	279.0 10.98	591.3	86.0	0.1115	31.90 70.29
H239649D	H239610	3.3 0.13	209.0 8.23	4.8 0.19	293.0 11.54	905.7	90.3	0.1242	52.73 116.28
H239649D	H239612	3.3 0.13	209.0 8.23	4.8 0.19	293.0 11.54	905.7	90.3	0.1242	53.29 117.48
93751D	93125	6.4 0.25	222.0 8.74	3.3 0.13	286.0 11.26	912.5	126.1	0.1460	41.89 92.37

<sup>(4)</sup>These maximum fillet radii will be cleared by bearing corners.  
NOTE: For spacer configuration information, contact your Timken engineer.

# TAPERED ROLLER BEARINGS

## DOUBLE-ROW • TYPE TDI

### TYPE TDI



Bearing Dimensions				Load Ratings							
Bore d	O.D. D	Width T	Double Inner Ring Width B	Dynamic <sup>(1)</sup>				Dynamic <sup>(3)</sup>			
				C <sub>1(2)</sub>	e	Y <sub>1</sub>	Y <sub>2</sub>	C <sub>90</sub>	C <sub>a90</sub>	C <sub>90(2)</sub>	K
mm in.	mm in.	mm in.	mm in.	N lbf				N lbf	N lbf	N lbf	
190.500 7.5000	368.300 14.5000	158.750 6.2500	152.400 6.0000	1920000 432000	0.4	1.7	2.5	286000 64300	197000 44200	498000 112000	1.45
199.975 7.8730	317.500 12.5000	133.350 5.2500	133.350 5.2500	1270000 286000	0.5	1.3	1.9	190000 42600	170000 38200	330000 74200	1.12
203.200 8.0000	317.500 12.5000	123.825 4.8750	123.825 4.8750	1270000 286000	0.5	1.3	1.9	190000 42600	170000 38200	330000 74200	1.12
203.200 8.0000	317.500 12.5000	133.350 5.2500	133.350 5.2500	1270000 286000	0.5	1.3	1.9	190000 42600	170000 38200	330000 74200	1.12
203.200 8.0000	317.500 12.5000	142.875 5.6250	133.350 5.2500	1270000 286000	0.5	1.3	1.9	190000 42600	170000 38200	330000 74200	1.12
203.200 8.0000	365.049 14.3720	158.750 6.2500	152.400 6.0000	1920000 432000	0.4	1.7	2.5	286000 64300	197000 44200	498000 112000	1.45
203.275 8.0030	368.300 14.5000	158.750 6.2500	152.400 6.0000	1920000 432000	0.4	1.7	2.5	286000 64300	197000 44200	498000 112000	1.45
206.375 8.1250	282.575 11.1250	87.313 3.4375	87.312 3.4375	738000 166000	0.5	1.3	2.0	110000 24700	95800 21500	191000 43000	1.15
206.375 8.1250	336.550 13.2500	180.975 7.1250	184.150 7.2500	2360000 530000	0.3	2.0	3.0	351000 79000	200000 45000	612000 137000	1.76
215.900 8.5000	285.750 11.2500	85.725 3.3750	85.725 3.3750	748000 168000	0.5	1.4	2.1	111000 25000	91800 20600	194000 43600	1.21
215.900 8.5000	288.925 11.3750	85.725 3.3750	85.725 3.3750	748000 168000	0.5	1.4	2.1	111000 25000	91800 20600	194000 43600	1.21
215.900 8.5000	355.600 14.0000	120.650 4.7500	120.650 4.7500	1390000 312000	0.3	2.0	3.0	206000 46400	117000 26200	359000 80800	1.77
215.900 8.5000	355.600 14.0000	127.000 5.0000	130.175 5.1250	1320000 297000	0.6	1.1	1.7	197000 44200	199000 44700	343000 77000	0.99
219.075 8.6250	358.775 14.1250	196.850 7.7500	200.025 7.8750	2520000 566000	0.3	2.0	3.0	375000 84200	213000 47900	652000 147000	1.76
220.662 8.6875	314.325 12.3750	115.888 4.5625	115.888 4.5625	1210000 272000	0.3	2.0	3.0	180000 40500	103000 23100	314000 70500	1.76
225.425 8.8750	355.600 14.0000	120.650 4.7500	120.650 4.7500	1390000 312000	0.3	2.0	3.0	206000 46400	117000 26200	359000 80800	1.77
225.425 8.8750	355.600 14.0000	165.100 6.5000	165.100 6.5000	1390000 312000	0.3	2.0	3.0	206000 46400	117000 26200	359000 80800	1.77

<sup>(1)</sup>Based on 1 x 10<sup>6</sup> revolutions L<sub>10</sub> life, for the ISO life-calculation method. C<sub>1(2)</sub> is the double-row radial value.

<sup>(2)</sup>Consult your Timken engineer for instructions on use or review the Timken Engineering Manual on [timken.com/catalogs](http://timken.com/catalogs).

<sup>(3)</sup>Based on 90 x 10<sup>6</sup> revolutions L<sub>10</sub> life, for The Timken Company life-calculation method. C<sub>90</sub> and C<sub>a90</sub> are radial and thrust values for a single row. C<sub>90(2)</sub> is the double-row radial value.

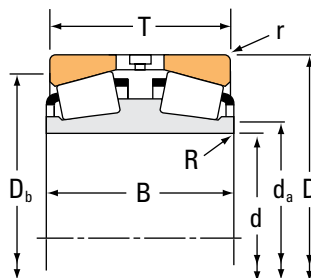
Part Number		Dimensions				Geometry Factors			Bearing Weight
Inner	Outer	Shaft		Housing		G <sub>1</sub>	G <sub>2</sub>	C <sub>g</sub>	
		Max Shaft Fillet Radius R <sup>(4)</sup>	Backing Shoulder Dia. d <sub>a</sub>	Max Housing Fillet Radius r <sup>(4)</sup>	Backing Shoulder Dia. D <sub>b</sub>				
		mm in.	mm in.	mm in.	mm in.				kg lbs.
EE420750D	421450	3.3 0.13	221.0 8.70	3.3 0.13	331.0 13.03	1150.5	128.2	0.1450	76.87 169.49
93788D	93125	6.4 0.25	226.9 8.93	3.3 0.13	286.0 11.26	912.5	126.1	0.1460	40.08 88.39
93800D	93125	1.5 0.06	222.0 8.74	3.3 0.13	286.0 11.26	912.5	126.1	0.1460	42.54 93.81
93801D	93125	6.4 0.25	226.9 8.93	3.3 0.13	286.0 11.26	912.5	126.1	0.1460	37.25 82.13
93801D	93126	6.4 0.25	226.9 8.93	3.3 0.13	285.0 11.22	912.5	126.1	0.1460	38.99 85.94
EE420800D	421437	3.3 0.13	230.0 9.06	3.3 0.13	329.0 12.95	1150.5	128.2	0.1450	70.53 155.49
EE420804D	421450	3.3 0.13	231.0 9.09	3.3 0.13	331.0 13.03	1150.5	128.2	0.1450	71.12 156.80
67985D	67920	0.8 0.03	219.0 8.62	3.3 0.13	260.0 10.24	819.5	172.0	0.1388	16.43 36.26
H242649D	H242610	1.5 0.06	227.0 8.94	3.3 0.13	306.0 12.05	1404.1	134.8	0.1465	65.06 143.45
LM742749D	LM742710	0.8 0.03	227.0 8.94	3.3 0.13	266.0 10.47	866.9	225.2	0.1388	15.15 33.37
LM742749D	LM742714	0.8 0.03	227.0 8.94	3.3 0.13	267.0 10.51	866.9	225.2	0.1388	15.88 35.00
EE130850D	131400	1.5 0.06	237.0 9.33	1.5 0.06	329.0 12.95	1162.0	167.6	0.1358	46.68 102.93
96851D	96140	6.4 0.25	249.0 9.80	3.3 0.13	318.0 12.52	1140.0	160.6	0.1626	51.05 112.57
H244849D	H244810	1.5 0.06	242.0 9.53	6.4 0.25	323.0 12.72	1631.9	150.0	0.1540	81.11 178.83
M244249D	M244210	1.5 0.06	235.0 9.25	3.3 0.13	293.0 11.54	1149.7	141.4	0.1360	29.07 64.10
EE130887D	131400	5.5 0.22	252.0 9.92	1.5 0.06	329.0 12.95	1162.0	167.6	0.1358	43.70 96.35
EE130888D	131400	8.0 0.31	257.0 10.12	1.5 0.06	329.0 12.95	1162.0	167.6	0.1358	52.19 115.07

<sup>(4)</sup>These maximum fillet radii will be cleared by bearing corners.  
NOTE: For spacer configuration information, contact your Timken engineer.

# TAPERED ROLLER BEARINGS

## DOUBLE-ROW • TYPE TDI

### TYPE TDI



Bearing Dimensions				Load Ratings							
Bore d	O.D. D	Width T	Double Inner Ring Width B	Dynamic <sup>(1)</sup>				Dynamic <sup>(3)</sup>			
				C <sub>1(2)</sub>	e	Y <sub>1</sub>	Y <sub>2</sub>	C <sub>90</sub>	C <sub>a90</sub>	C <sub>90(2)</sub>	K
mm in.	mm in.	mm in.	mm in.	N lbf				N lbf	N lbf	N lbf	
228.600 9.0000	355.600 14.0000	120.650 4.7500	120.650 4.7500	1390000 312000	0.3	2.0	3.0	206000 46400	117000 26200	359000 80800	1.77
228.600 9.0000	355.600 14.0000	165.100 6.5000	165.100 6.5000	1390000 312000	0.3	2.0	3.0	206000 46400	117000 26200	359000 80800	1.77
228.600 9.0000	400.050 15.7500	158.750 6.2500	161.925 6.3750	1960000 440000	0.4	1.5	2.3	291000 65500	219000 49300	507000 114000	1.33
228.600 9.0000	425.450 16.7500	177.800 7.0000	165.100 6.5000	2700000 608000	0.3	2.0	3.0	402000 90500	229000 51500	701000 158000	1.76
228.600 9.0000	431.800 17.0000	158.749 6.2500	158.750 6.2500	2220000 499000	0.9	0.8	1.1	330000 74300	500000 112000	575000 129000	0.66
234.950 9.2500	327.025 12.8750	93.662 3.6875	93.662 3.6875	918000 206000	0.4	1.7	2.5	137000 30700	95200 21400	238000 53500	1.44
234.950 9.2500	384.175 15.1250	209.550 8.2500	209.550 8.2500	3090000 694000	0.3	2.0	3.0	460000 103000	262000 58800	800000 180000	1.76
241.225 9.4970	355.498 13.9960	107.950 4.2500	107.950 4.2500	1150000 258000	0.4	1.9	2.9	171000 38500	103000 23300	298000 67000	1.65
241.300 9.5000	419.100 16.5000	177.800 7.0000	174.625 6.8750	2650000 595000	0.4	1.6	2.4	394000 88600	281000 63100	686000 154000	1.40
241.478 9.5070	349.148 13.7460	107.950 4.2500	107.950 4.2500	1150000 258000	0.4	1.9	2.9	171000 38500	103000 23300	298000 67000	1.65
241.478 9.5070	355.498 13.9960	107.950 4.2500	107.950 4.2500	1150000 258000	0.4	1.9	2.9	171000 38500	103000 23300	298000 67000	1.65
241.478 9.5070	355.600 14.0000	107.950 4.2500	107.950 4.2500	1150000 258000	0.4	1.9	2.9	171000 38500	103000 23300	298000 67000	1.65
244.475 9.6250	327.025 12.8750	92.075 3.6250	92.075 3.6250	987000 222000	0.3	2.1	3.1	147000 33000	80800 18200	256000 57500	1.82
247.650 9.7500	406.400 16.0000	215.900 8.5000	219.075 8.6250	3420000 769000	0.3	2.0	3.0	509000 115000	290000 65200	887000 199000	1.76
254.000 10.0000	355.600 14.0000	92.710 3.6500	92.862 3.6560	976000 219000	0.4	1.9	2.8	145000 32700	90200 20300	253000 56900	1.61
254.000 10.0000	358.775 14.1250	130.175 5.1250	130.175 5.1250	1590000 358000	0.3	2.0	3.0	237000 53300	135000 30300	413000 92800	1.76
254.000 10.0000	360.000 14.1732	136.225 5.3632	130.175 5.1250	1590000 358000	0.3	2.0	3.0	237000 53300	135000 30300	413000 92800	1.76

<sup>(1)</sup>Based on 1 x 10<sup>6</sup> revolutions L<sub>10</sub> life, for the ISO life-calculation method. C<sub>1(2)</sub> is the double-row radial value.

<sup>(2)</sup>Consult your Timken engineer for instructions on use or review the Timken Engineering Manual on [timken.com/catalogs](http://timken.com/catalogs).

<sup>(3)</sup>Based on 90 x 10<sup>6</sup> revolutions L<sub>10</sub> life, for The Timken Company life-calculation method. C<sub>90</sub> and C<sub>a90</sub> are radial and thrust values for a single row. C<sub>90(2)</sub> is the double-row radial value.

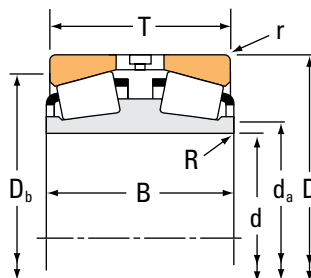
Part Number		Dimensions				Geometry Factors			Bearing Weight
Inner	Outer	Shaft		Housing		G <sub>1</sub>	G <sub>2</sub>	C <sub>g</sub>	
		Max Shaft Fillet Radius R <sup>(4)</sup>	Backing Shoulder Dia. d <sub>a</sub>	Max Housing Fillet Radius r <sup>(4)</sup>	Backing Shoulder Dia. D <sub>b</sub>				
		mm in.	mm in.	mm in.	mm in.				kg lbs.
EE130900D	131400	1.5 0.06	247.0 9.72	1.5 0.06	329.0 12.95	1162.0	167.6	0.1358	43.45 95.81
EE130903D	131400	8.0 0.31	259.0 10.20	1.5 0.06	329.0 12.95	1162.0	167.6	0.1358	50.40 111.14
EE430901D	431575	3.3 0.13	250.7 9.87	3.3 0.13	360.0 14.17	1351.2	142.8	0.1572	81.54 179.79
EE700090D	700167	3.5 0.14	259.0 10.20	6.4 0.25	381.0 15.00	1488.7	109.7	0.1480	106.49 234.79
EE113090D	113170	6.4 0.25	271.5 10.69	6.4 0.25	375.0 14.76	966.7	98.1	0.1723	102.14 225.16
8576D	8520	1.5 0.06	250.0 9.84	3.3 0.13	305.0 12.01	1050.5	172.4	0.1401	24.86 54.82
H247549D	H247510	1.5 0.06	259.0 10.20	6.4 0.25	346.0 13.62	1964.4	148.4	0.1638	98.04 216.13
EE127094D	127138	1.5 0.06	257.0 10.12	3.3 0.13	327.0 12.87	1178.6	164.4	0.1392	36.78 81.09
EE821096D	821165	3.3 0.13	268.0 10.55	6.4 0.25	380.0 14.96	1493.2	126.1	0.1597	101.84 224.52
EE127097D	127135	1.5 0.06	258.0 10.16	3.3 0.13	325.0 12.80	1178.6	164.4	0.1392	33.77 74.43
EE127097D	127138	1.5 0.06	258.0 10.16	3.3 0.13	327.0 12.87	1178.6	164.4	0.1392	35.08 77.32
EE127097D	127140	1.5 0.06	258.0 10.16	3.3 0.13	327.0 12.87	1178.6	164.4	0.1392	35.12 77.41
LM247748D	LM247710	1.5 0.06	257.0 10.12	3.3 0.13	310.0 12.20	1173.3	243.9	0.1345	21.53 47.46
HH249949D	HH249910	3.3 0.13	278.0 10.94	6.4 0.25	366.0 14.41	2373.9	173.3	0.1746	120.05 264.65
EE171000D	171400	1.5 0.06	269.0 10.59	3.3 0.13	334.0 13.15	1068.6	171.6	0.1354	27.99 61.70
M249748D	M249710	3.3 0.13	272.5 10.73	3.3 0.13	335.0 13.19	1626.0	173.0	0.1526	42.34 93.34
M249748D	JM249712	3.3 0.13	272.5 10.73	3.0 0.12	336.0 13.23	1626.0	173.0	0.1526	44.36 97.78

<sup>(4)</sup>These maximum fillet radii will be cleared by bearing corners.  
NOTE: For spacer configuration information, contact your Timken engineer.

# TAPERED ROLLER BEARINGS

## DOUBLE-ROW • TYPE TDI

### TYPE TDI



Bearing Dimensions				Load Ratings							
Bore d	O.D. D	Width T	Double Inner Ring Width B	Dynamic <sup>(1)</sup>				Dynamic <sup>(3)</sup>			
				C <sub>1(2)</sub>	e	Y <sub>1</sub>	Y <sub>2</sub>	C <sub>90</sub>	C <sub>a90</sub>	C <sub>90(2)</sub>	K
mm in.	mm in.	mm in.	mm in.	N lbf				N lbf	N lbf	N lbf	
254.000 10.0000	365.049 14.3720	92.710 3.6500	92.862 3.6560	976000 219000	0.4	1.9	2.8	145000 32700	90200 20300	253000 56900	1.61
254.000 10.0000	368.300 14.5000	92.710 3.6500	92.862 3.6560	976000 219000	0.4	1.9	2.8	145000 32700	90200 20300	253000 56900	1.61
254.000 10.0000	422.275 16.6250	152.400 6.0000	139.700 5.5000	2610000 587000	0.3	2.0	3.0	389000 87400	221000 49700	677000 152000	1.76
254.000 10.0000	431.724 16.9970	145.258 5.7188	139.700 5.5000	2610000 587000	0.3	2.0	3.0	389000 87400	221000 49700	677000 152000	1.76
254.000 10.0000	438.150 17.2500	165.100 6.5000	165.100 6.5000	2470000 555000	0.4	1.9	2.8	368000 82700	226000 50700	640000 144000	1.63
254.000 10.0000	444.500 17.5000	133.350 5.2500	133.350 5.2500	2050000 460000	0.3	2.0	3.0	305000 68500	178000 40000	531000 119000	1.71
260.350 10.2500	365.125 14.3750	107.950 4.2500	107.950 4.2500	1180000 266000	0.4	1.8	2.7	176000 39600	113000 25400	307000 68900	1.56
260.350 10.2500	406.400 16.0000	155.575 6.1250	152.400 6.0000	2040000 459000	0.3	2.0	3.0	304000 68300	173000 39000	529000 119000	1.75
260.350 10.2500	419.100 16.5000	158.750 6.2500	155.575 6.1250	1960000 440000	0.6	1.1	1.7	291000 65500	302000 67800	507000 114000	0.97
260.350 10.2500	422.275 16.6250	152.400 6.0000	139.700 5.5000	2610000 587000	0.3	2.0	3.0	389000 87400	221000 49700	677000 152000	1.76
260.350 10.2500	431.724 16.9970	145.258 5.7188	139.700 5.5000	2610000 587000	0.3	2.0	3.0	389000 87400	221000 49700	677000 152000	1.76
260.350 10.2500	431.724 16.9970	148.433 5.8438	152.400 6.0000	2610000 587000	0.3	2.0	3.0	389000 87400	221000 49700	677000 152000	1.76
260.350 10.2500	444.500 17.5000	196.850 7.7500	196.850 7.7500	2810000 631000	0.6	1.2	1.8	418000 94000	391000 87800	728000 164000	1.07
266.700 10.5000	355.600 14.0000	107.950 4.2500	109.538 4.3125	1400000 315000	0.4	1.9	2.8	209000 46900	129000 28900	363000 81600	1.62
266.700 10.5000	393.700 15.5000	130.175 5.1250	130.175 5.1250	1540000 345000	0.4	1.7	2.5	229000 51400	157000 35400	398000 89600	1.45
266.700 10.5000	403.225 15.8750	122.240 4.8126	130.175 5.1250	1540000 345000	0.4	1.7	2.5	229000 51400	157000 35400	398000 89600	1.45
266.700 10.5000	406.400 16.0000	122.240 4.8126	130.175 5.1250	1540000 345000	0.4	1.7	2.5	229000 51400	157000 35400	398000 89600	1.45

<sup>(1)</sup>Based on 1 x 10<sup>6</sup> revolutions L<sub>10</sub> life, for the ISO life-calculation method. C<sub>1(2)</sub> is the double-row radial value.

<sup>(2)</sup>Consult your Timken engineer for instructions on use or review the Timken Engineering Manual on [timken.com/catalogs](http://timken.com/catalogs).

<sup>(3)</sup>Based on 90 x 10<sup>6</sup> revolutions L<sub>10</sub> life, for The Timken Company life-calculation method. C<sub>90</sub> and C<sub>a90</sub> are radial and thrust values for a single row. C<sub>90(2)</sub> is the double-row radial value.

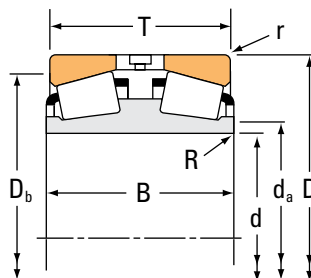
Part Number		Dimensions				Geometry Factors			Bearing Weight
Inner	Outer	Shaft		Housing		G <sub>1</sub>	G <sub>2</sub>	C <sub>g</sub>	
		Max Shaft Fillet Radius R <sup>(4)</sup>	Backing Shoulder Dia. d <sub>a</sub>	Max Housing Fillet Radius r <sup>(4)</sup>	Backing Shoulder Dia. D <sub>b</sub>				
		mm in.	mm in.	mm in.	mm in.				kg lbs.
EE171000D	171436	1.5 0.06	269.0 10.59	3.3 0.13	338.0 13.31	1068.6	171.6	0.1354	30.85 68.02
EE171000D	171450	1.5 0.06	269.0 10.59	3.3 0.13	340.0 13.39	1068.6	171.6	0.1354	32.05 70.66
HM252343D	HM252310	3.5 0.14	281.0 11.06	3.3 0.13	392.0 15.43	1504.3	147.8	0.1482	81.05 178.65
HM252343D	HM252315	3.5 0.14	281.0 11.06	3.5 0.14	397.0 15.63	1504.3	147.8	0.1482	82.79 182.53
EE738101D	738172	3.3 0.13	284.0 11.18	6.4 0.25	401.1 15.79	1756.1	131.0	0.1601	105.97 233.61
EE822101D	822175	3.3 0.13	281.9 11.10	6.4 0.25	404.9 15.94	1363.4	186.1	0.1442	84.48 186.26
EE134102D	134143	3.3 0.13	280.0 11.02	6.4 0.25	339.0 13.35	1327.7	187.2	0.1474	33.76 74.46
EE324103D	324160	6.4 0.25	287.3 11.31	3.3 0.13	376.0 14.80	1736.8	222.5	0.1559	121.01 266.81
EE435103D	435165	3.3 0.13	289.0 11.38	3.3 0.13	376.0 14.80	1480.2	123.2	0.1787	80.70 177.89
HM252347D	HM252310	3.5 0.14	285.0 11.22	3.3 0.13	392.0 15.43	1504.3	147.8	0.1482	76.62 168.90
HM252347D	HM252315	3.5 0.14	285.0 11.22	3.5 0.14	397.0 15.63	1504.3	147.8	0.1482	79.98 176.34
HM252348D	HM252315	6.4 0.25	291.0 11.46	3.5 0.14	397.0 15.63	1504.3	147.8	0.1482	81.35 179.37
EE823103D	823175	6.4 0.25	295.5 11.63	3.3 0.13	399.0 15.71	1686.2	159.0	0.1813	119.46 263.37
LM451349D	LM451310	1.5 0.06	281.0 11.06	3.3 0.13	335.0 13.19	1554.1	212.2	0.1536	30.19 66.56
EE275106D	275155	3.3 0.13	290.0 11.42	6.4 0.25	366.0 14.41	1451.8	201.3	0.1555	49.03 108.10
EE275106D	275158	3.3 0.13	290.0 11.42	6.4 0.25	371.0 14.61	1451.8	201.3	0.1555	51.81 114.20
EE275106D	275160	3.3 0.13	290.0 11.42	6.4 0.25	373.0 14.69	1451.8	201.3	0.1555	53.51 117.97

<sup>(4)</sup>These maximum fillet radii will be cleared by bearing corners.  
NOTE: For spacer configuration information, contact your Timken engineer.

# TAPERED ROLLER BEARINGS

## DOUBLE-ROW • TYPE TDI

### TYPE TDI



Bearing Dimensions				Load Ratings							
Bore d	O.D. D	Width T	Double Inner Ring Width B	Dynamic <sup>(1)</sup>				Dynamic <sup>(3)</sup>			
				C <sub>1(2)</sub>	e	Factors <sup>(2)</sup> Y <sub>1</sub>	Y <sub>2</sub>	C <sub>90</sub>	C <sub>a90</sub>	C <sub>90(2)</sub>	Factors <sup>(2)</sup> K
mm in.	mm in.	mm in.	mm in.	N lbf				N lbf	N lbf	N lbf	
266.700 10.5000	488.950 19.2500	228.600 9.0000	238.125 9.3750	4220000 948000	0.3	2.2	3.2	628000 141000	336000 75600	1090000 246000	1.87
269.875 10.6250	381.000 15.0000	136.525 5.3750	136.525 5.3750	2000000 450000	0.3	2.0	3.0	298000 67000	170000 38100	519000 117000	1.76
276.225 10.8750	381.000 15.0000	95.250 3.7500	88.900 3.5000	806000 181000	0.6	1.2	1.7	120000 27000	120000 26900	209000 47000	1.00
276.225 10.8750	381.000 15.0000	111.125 4.3750	88.900 3.5000	806000 181000	0.6	1.2	1.7	120000 27000	120000 26900	209000 47000	1.00
276.225 10.8750	393.700 15.5000	130.175 5.1250	130.175 5.1250	1540000 345000	0.4	1.7	2.5	229000 51400	157000 35400	398000 89600	1.45
276.225 10.8750	403.225 15.8750	122.240 4.8126	130.175 5.1250	1540000 345000	0.4	1.7	2.5	229000 51400	157000 35400	398000 89600	1.45
279.400 11.0000	457.200 18.0000	244.475 9.6250	244.475 9.6250	4560000 1020000	0.3	2.0	3.0	679000 153000	386000 86800	1180000 266000	1.76
279.400 11.0000	469.900 18.5000	169.862 6.6875	166.688 6.5625	2810000 631000	0.4	1.8	2.7	418000 94000	271000 60800	728000 164000	1.55
279.578 11.0070	380.898 14.9960	117.475 4.6250	117.475 4.6250	1260000 283000	0.4	1.6	2.3	187000 42100	138000 31100	326000 73300	1.35
279.578 11.0070	381.000 15.0000	95.250 3.7500	88.900 3.5000	806000 181000	0.6	1.2	1.7	120000 27000	120000 26900	209000 47000	1.00
279.578 11.0070	381.000 15.0000	111.125 4.3750	88.900 3.5000	806000 181000	0.6	1.2	1.7	120000 27000	120000 26900	209000 47000	1.00
280.000 11.0236	409.981 16.1410	206.375 8.1250	206.375 8.1250	1610000 362000	0.4	1.8	2.6	240000 53900	158000 35600	417000 93800	1.51
288.925 11.3750	406.400 16.0000	144.462 5.6875	144.462 5.6875	2070000 466000	0.3	2.0	3.0	308000 69300	179000 40100	537000 121000	1.73
292.100 11.5000	422.275 16.6250	130.175 5.1250	130.175 5.1250	1890000 426000	0.3	2.1	3.1	282000 63400	154000 34700	491000 110000	1.83
292.100 11.5000	469.900 18.5000	138.928 5.4696	142.875 5.6250	2630000 591000	0.3	2.3	3.4	391000 88000	196000 44000	681000 153000	2.00
292.100 11.5000	476.250 18.7500	138.928 5.4696	142.875 5.6250	2630000 591000	0.3	2.3	3.4	391000 88000	196000 44000	681000 153000	2.00
298.450 11.7500	438.048 17.2460	131.762 5.1875	131.762 5.1875	1880000 422000	0.3	2.0	3.0	280000 62900	159000 35700	487000 110000	1.76

<sup>(1)</sup>Based on 1 x 10<sup>6</sup> revolutions L<sub>10</sub> life, for the ISO life-calculation method. C<sub>1(2)</sub> is the double-row radial value.

<sup>(2)</sup>Consult your Timken engineer for instructions on use or review the Timken Engineering Manual on [timken.com/catalogs](http://timken.com/catalogs).

<sup>(3)</sup>Based on 90 x 10<sup>6</sup> revolutions L<sub>10</sub> life, for The Timken Company life-calculation method. C<sub>90</sub> and C<sub>a90</sub> are radial and thrust values for a single row. C<sub>90(2)</sub> is the double-row radial value.



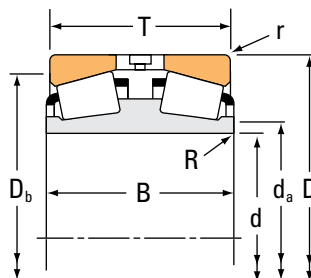
Part Number		Dimensions				Geometry Factors			Bearing Weight
Inner	Outer	Shaft		Housing		G <sub>1</sub>	G <sub>2</sub>	C <sub>g</sub>	
		Max Shaft Fillet Radius R <sup>(4)</sup>	Backing Shoulder Dia. d <sub>a</sub>	Max Housing Fillet Radius r <sup>(4)</sup>	Backing Shoulder Dia. D <sub>b</sub>				
		mm in.	mm in.	mm in.	mm in.				kg lbs.
EE295106D	295193	6.4 0.25	304.0 11.97	6.4 0.25	444.0 17.48	2247.3	171.9	0.1664	184.42 406.60
M252349D	M252310	3.3 0.13	290.0 11.42	3.3 0.13	356.0 14.02	1839.2	226.1	0.1588	49.93 110.07
89108D	89148	3.3 0.13	297.0 11.69	3.3 0.13	354.0 13.94	1111.9	274.1	0.1586	29.21 64.38
89108D	89150	3.3 0.13	297.0 11.69	6.4 0.25	348.0 13.70	1111.9	274.1	0.1586	32.47 71.59
EE275109D	275155	1.5 0.06	293.6 11.56	6.4 0.25	366.0 14.41	1451.8	201.3	0.1555	49.79 109.79
EE275109D	275158	1.5 0.06	293.6 11.56	6.4 0.25	371.0 14.61	1451.8	201.3	0.1555	51.43 113.36
HH255149D	HH255110	1.5 0.06	309.0 12.17	6.4 0.25	412.0 16.22	3174.6	193.1	0.1922	169.04 372.70
EE722111D	722185	6.4 0.25	314.0 12.36	3.3 0.13	430.0 16.93	1894.4	142.6	0.1669	114.93 253.34
LM654644D	LM654610	1.5 0.06	297.0 11.69	3.3 0.13	356.0 14.02	1916.4	265.6	0.1744	40.56 89.44
89111D	89148	3.3 0.13	299.0 11.77	3.3 0.13	354.0 13.94	1111.9	274.1	0.1586	28.21 62.16
89111D	89150	3.3 0.13	299.0 11.77	6.4 0.25	348.0 13.70	1111.9	274.1	0.1586	31.47 69.37
EE128114D	128161	3.3 0.13	302.0 11.89	3.3 0.13	379.0 14.92	1727.7	255.2	0.1628	83.02 183.02
M255449D	M255410	3.3 0.13	310.0 12.20	3.3 0.13	379.0 14.92	2301.3	287.6	0.1722	60.77 134.00
EE330116D	330166	6.4 0.25	314.2 12.37	3.3 0.13	395.0 15.55	1950.7	301.9	0.1594	61.13 134.78
EE921150D	921850	1.5 0.06	314.0 12.36	3.3 0.13	439.0 17.28	1732.1	200.0	0.1481	88.34 194.78
EE921150D	921875	1.5 0.06	314.0 12.36	3.3 0.13	442.0 17.40	1732.1	200.0	0.1481	92.56 204.07
EE329118D	329172	3.3 0.13	323.0 12.72	3.3 0.13	410.0 16.14	2051.2	257.0	0.1638	64.02 141.15

<sup>(4)</sup>These maximum fillet radii will be cleared by bearing corners.  
NOTE: For spacer configuration information, contact your Timken engineer.

# TAPERED ROLLER BEARINGS

## DOUBLE-ROW • TYPE TDI

### TYPE TDI



Bearing Dimensions				Load Ratings							
Bore d	O.D. D	Width T	Double Inner Ring Width B	Dynamic <sup>(1)</sup>				Dynamic <sup>(3)</sup>			
				C <sub>1(2)</sub>	e	Y <sub>1</sub>	Y <sub>2</sub>	C <sub>90</sub>	C <sub>a90</sub>	C <sub>90(2)</sub>	K
mm in.	mm in.	mm in.	mm in.	N lbf				N lbf	N lbf	N lbf	
298.450 11.7500	444.500 17.5000	111.125 4.3750	107.950 4.2500	1540000 347000	0.4	1.8	2.7	230000 51700	149000 33400	400000 90000	1.55
299.975 11.8100	439.948 17.3208	133.350 5.2500	134.938 5.3125	1560000 351000	0.4	1.6	2.4	232000 52200	165000 37200	405000 91000	1.40
300.000 11.8110	460.000 18.1102	160.000 6.2992	160.000 6.2992	2920000 656000	0.3	2.0	3.0	435000 97800	249000 56000	757000 170000	1.74
300.038 11.8125	422.275 16.6250	150.812 5.9375	150.812 5.9375	2260000 508000	0.3	2.0	3.0	336000 75600	194000 43600	586000 132000	1.73
300.038 11.8125	422.275 16.6250	150.812 5.9375	150.812 5.9375	2260000 508000	0.3	2.0	3.0	336000 75600	194000 43600	586000 132000	1.73
303.212 11.9375	495.300 19.5000	263.525 10.3750	263.525 10.3750	5000000 1120000	0.3	2.0	3.0	744000 167000	423000 95200	1300000 291000	1.76
304.648 11.9940	438.048 17.2460	131.762 5.1875	131.762 5.1875	1920000 432000	0.3	2.0	3.0	286000 64300	162000 36500	498000 112000	1.76
304.648 11.9940	438.048 17.2460	133.350 5.2500	134.938 5.3125	1560000 351000	0.4	1.6	2.4	232000 52200	165000 37200	405000 91000	1.40
304.648 11.9940	438.048 17.2460	138.112 5.4375	128.588 5.0625	1910000 430000	0.5	1.4	2.1	285000 64000	231000 51800	496000 111000	1.24
304.800 12.0000	419.100 16.5000	130.175 5.1250	130.175 5.1250	2080000 468000	0.3	2.0	3.0	310000 69700	176000 39700	540000 121000	1.76
304.800 12.0000	444.500 17.5000	111.125 4.3750	107.950 4.2500	1540000 347000	0.4	1.8	2.7	230000 51700	149000 33400	400000 90000	1.55
304.800 12.0000	444.500 17.5000	111.125 4.3750	107.950 4.2500	1540000 347000	0.4	1.8	2.7	230000 51700	149000 33400	400000 90000	1.55
304.800 12.0000	495.300 19.5000	171.450 6.7500	165.100 6.5000	2940000 660000	0.4	1.7	2.5	437000 98300	301000 67700	762000 171000	1.45
304.800 12.0000	501.650 19.7500	161.925 6.3750	161.925 6.3750	3120000 702000	0.3	2.0	3.0	465000 105000	265000 59500	809000 182000	1.76
304.800 12.0000	558.800 22.0000	285.750 11.2500	285.750 11.2500	5390000 1210000	0.4	1.7	2.5	802000 180000	542000 122000	1400000 314000	1.48
304.902 12.0040	412.648 16.2460	128.588 5.0625	128.588 5.0625	1940000 437000	0.3	2.1	3.2	289000 65000	158000 35500	504000 113000	1.83
304.902 12.0040	438.048 17.2460	196.850 7.7500	212.725 8.3750	1560000 351000	0.4	1.6	2.4	232000 52200	165000 37200	405000 91000	1.40

<sup>(1)</sup>Based on 1 x 10<sup>6</sup> revolutions L<sub>10</sub> life, for the ISO life-calculation method. C<sub>1(2)</sub> is the double-row radial value.

<sup>(2)</sup>Consult your Timken engineer for instructions on use or review the Timken Engineering Manual on [timken.com/catalogs](http://timken.com/catalogs).

<sup>(3)</sup>Based on 90 x 10<sup>6</sup> revolutions L<sub>10</sub> life, for The Timken Company life-calculation method. C<sub>90</sub> and C<sub>a90</sub> are radial and thrust values for a single row. C<sub>90(2)</sub> is the double-row radial value.

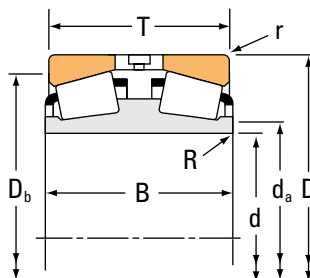
Part Number		Dimensions				Geometry Factors			Bearing Weight
Inner	Outer	Shaft		Housing		G <sub>1</sub>	G <sub>2</sub>	C <sub>g</sub>	
		Max Shaft Fillet Radius R <sup>(4)</sup>	Backing Shoulder Dia. d <sub>a</sub>	Max Housing Fillet Radius r <sup>(4)</sup>	Backing Shoulder Dia. D <sub>b</sub>				
		mm in.	mm in.	mm in.	mm in.				kg lbs.
EE291176D	291750	8.0 0.31	332.0 13.07	1.5 0.06	416.0 16.38	1579.2	244.8	0.1557	54.57 120.32
EE129119D	129174	3.3 0.13	324.0 12.76	4.8 0.19	407.0 16.02	1882.6	272.9	0.1711	67.14 148.02
NP741064	NP034947	4.0 0.16	340.0 13.39	4.0 0.16	423.0 16.65	2944.6	303.9	0.1863	104.21 229.75
HM256849DA	HM256810	6.4 0.25	324.7 12.79	3.3 0.13	394.0 15.51	2548.4	281.8	0.1779	67.50 148.82
HM256849D	HM256810	3.3 0.13	322.0 12.68	3.3 0.13	394.0 15.51	2548.4	281.8	0.1779	69.57 153.37
HH258249D	HH258210	3.3 0.13	339.0 13.35	6.4 0.25	448.0 17.64	3853.2	220.0	0.2048	213.93 471.64
EE329117D	329172	3.3 0.13	327.0 12.87	3.3 0.13	410.0 16.14	2095.9	262.4	0.1651	64.30 141.77
EE129121D	129172	3.3 0.13	327.0 12.87	4.8 0.19	406.0 15.98	1882.6	272.9	0.1711	60.89 134.22
M757447D	M757410	3.3 0.13	328.0 12.91	4.8 0.19	407.0 16.02	1841.4	253.5	0.1775	64.10 141.35
M257149D	M257110	1.5 0.06	322.0 12.68	6.4 0.25	392.0 15.43	2157.5	303.6	0.1669	52.61 115.99
EE291200D	291750	8.0 0.31	337.0 13.27	1.5 0.06	416.0 16.38	1579.2	244.8	0.1557	52.03 114.71
EE291200D	291749	8.0 0.31	337.0 13.27	3.3 0.13	415.0 16.34	1579.2	244.8	0.1557	55.22 121.75
EE724121D	724195	3.3 0.13	334.0 13.15	6.4 0.25	450.0 17.72	2183.9	165.7	0.1783	125.31 276.25
HM258949D	HM258910	3.3 0.13	332.0 13.07	6.4 0.25	464.0 18.27	2160.7	183.0	0.1669	130.56 287.86
EE790119D	790221	3.3 0.13	339.0 13.35	6.4 0.25	501.0 19.72	2663.9	170.3	0.1898	296.99 654.78
M257248D	M257210	3.3 0.13	325.0 12.80	3.3 0.13	388.0 15.28	2336.4	320.3	0.1690	50.79 112.00
EE129124D	129172	3.3 0.13	328.0 12.91	4.8 0.19	406.0 15.98	1882.6	272.9	0.1711	87.48 192.84

<sup>(4)</sup>These maximum fillet radii will be cleared by bearing corners.  
NOTE: For spacer configuration information, contact your Timken engineer.

# TAPERED ROLLER BEARINGS

## DOUBLE-ROW • TYPE TDI

### TYPE TDI



Bearing Dimensions				Load Ratings							
Bore d	O.D. D	Width T	Double Inner Ring Width B	Dynamic <sup>(1)</sup>				Dynamic <sup>(3)</sup>			
				C <sub>1(2)</sub>	e	Factors <sup>(2)</sup> Y <sub>1</sub>	Y <sub>2</sub>	C <sub>90</sub>	C <sub>a90</sub>	C <sub>90(2)</sub>	Factors <sup>(2)</sup> K
mm in.	mm in.	mm in.	mm in.	N lbf				N lbf	N lbf	N lbf	
305.000 12.0079	438.048 17.2460	133.350 5.2500	134.938 5.3125	1560000 351000	0.4	1.6	2.4	232000 52200	165000 37200	405000 91000	1.40
305.000 12.0079	559.867 22.0420	170.434 6.7100	169.977 6.6920	2690000 605000	0.9	0.8	1.2	401000 90100	594000 134000	698000 157000	0.67
305.054 12.0100	499.948 19.6830	200.000 7.8740	200.000 7.8740	3360000 756000	0.5	1.4	2.0	501000 113000	424000 95400	872000 196000	1.18
317.500 12.5000	422.275 16.6250	128.588 5.0625	128.588 5.0625	1720000 386000	0.3	2.1	3.2	256000 57500	140000 31400	445000 100000	1.83
317.500 12.5000	447.675 17.6250	158.750 6.2500	158.750 6.2500	2920000 656000	0.3	2.0	3.0	435000 97800	249000 56000	757000 170000	1.74
330.200 13.0000	414.338 16.3125	76.200 3.0000	76.200 3.0000	899000 202000	0.3	2.0	3.0	134000 30100	76200 17100	233000 52400	1.76
330.200 13.0000	482.600 19.0000	152.400 6.0000	147.638 5.8125	2180000 489000	0.4	1.7	2.6	324000 72900	217000 48700	564000 127000	1.49
330.302 13.0040	438.023 17.2450	120.650 4.7500	114.300 4.5000	1280000 287000	0.5	1.5	2.2	190000 42800	149000 33600	331000 74500	1.27
333.375 13.1250	469.900 18.5000	166.688 6.5625	166.688 6.5625	2780000 626000	0.3	2.0	3.0	415000 93200	238000 53400	722000 162000	1.74
340.000 13.3858	460.000 18.1102	118.364 4.6600	118.000 4.6457	1280000 287000	0.3	2.2	3.3	190000 42700	100000 22500	331000 74400	1.90
342.900 13.5000	533.400 21.0000	139.700 5.5000	146.050 5.7500	3010000 676000	0.3	2.0	3.0	448000 101000	255000 57300	780000 175000	1.76
343.052 13.5060	457.098 17.9960	120.650 4.7500	120.650 4.7500	1210000 273000	0.5	1.4	2.1	181000 40700	149000 33400	315000 70800	1.22
343.052 13.5060	457.098 17.9960	122.238 4.8125	122.238 4.8125	1590000 358000	0.5	1.4	2.1	237000 53400	192000 43200	413000 92900	1.24
343.052 13.5060	457.098 17.9960	123.825 4.8750	122.238 4.8125	1430000 322000	0.7	1.0	1.4	213000 48000	260000 58500	371000 83500	0.82
346.075 13.6250	469.900 18.5000	104.775 4.1250	95.250 3.7500	954000 214000	0.5	1.4	2.0	142000 31900	122000 27400	247000 55600	1.17
346.075 13.6250	482.600 19.0000	104.775 4.1250	95.250 3.7500	954000 214000	0.5	1.4	2.0	142000 31900	122000 27400	247000 55600	1.17
346.075 13.6250	488.950 19.2500	104.775 4.1250	95.250 3.7500	954000 214000	0.5	1.4	2.0	142000 31900	122000 27400	247000 55600	1.17

<sup>(1)</sup>Based on 1 x 10<sup>6</sup> revolutions L<sub>10</sub> life, for the ISO life-calculation method. C<sub>1(2)</sub> is the double-row radial value.

<sup>(2)</sup>Consult your Timken engineer for instructions on use or review the Timken Engineering Manual on [timken.com/catalogs](http://timken.com/catalogs).

<sup>(3)</sup>Based on 90 x 10<sup>6</sup> revolutions L<sub>10</sub> life, for The Timken Company life-calculation method. C<sub>90</sub> and C<sub>a90</sub> are radial and thrust values for a single row. C<sub>90(2)</sub> is the double-row radial value.

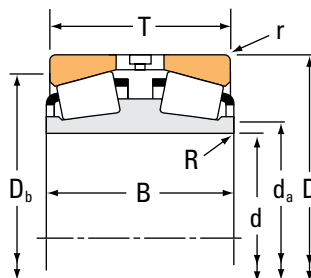
Part Number		Dimensions				Geometry Factors			Bearing Weight
Inner	Outer	Shaft		Housing		G <sub>1</sub>	G <sub>2</sub>	C <sub>g</sub>	
		Max Shaft Fillet Radius R <sup>(4)</sup>	Backing Shoulder Dia. d <sub>a</sub>	Max Housing Fillet Radius r <sup>(4)</sup>	Backing Shoulder Dia. D <sub>b</sub>				
		mm in.	mm in.	mm in.	mm in.				kg lbs.
EE129123D	129172	3.3 0.13	328.0 12.91	4.8 0.19	406.0 15.98	1882.6	272.9	0.1711	60.71 133.83
HM959649D	HM959618	3.3 0.13	345.9 13.62	4.8 0.19	485.0 19.09	1749.6	156.7	0.2084	181.92 401.07
HM858548D	HM858511	3.3 0.13	337.0 13.27	6.4 0.25	453.9 17.87	2310.5	179.9	0.1949	152.93 337.19
LM258649D	LM258610	1.5 0.06	333.3 13.12	3.3 0.13	398.0 15.67	2549.1	293.5	0.1739	48.23 106.32
HM259049D	HM259010	3.3 0.13	340.0 13.39	3.3 0.13	418.0 16.46	2944.6	303.9	0.1863	82.41 181.69
L259749D	L259710	1.5 0.06	343.0 13.50	3.3 0.13	398.0 15.67	1635.6	422.9	0.1502	23.77 52.43
EE526131D	526190	1.5 0.06	351.0 13.82	3.3 0.13	449.0 17.68	2283.3	287.2	0.1790	83.06 183.13
EE138131D	138172	1.5 0.06	347.0 13.66	3.3 0.13	412.0 16.22	1974.6	290.4	0.1786	46.18 101.82
HM261049D	HM261010	3.3 0.13	357.0 14.06	3.3 0.13	439.0 17.28	3306.8	324.3	0.1935	95.39 210.29
JL163142D	JL163115	3.5 0.14	363.0 14.29	3.5 0.14	430.0 16.93	3207.7	621.3	0.1838	60.72 133.89
EE971355D	972100	3.3 0.13	370.0 14.57	3.3 0.13	501.0 19.72	2433.2	282.5	0.1730	113.46 250.13
EE133136D	133180	1.5 0.06	361.0 14.21	3.3 0.13	430.0 16.93	2053.9	306.0	0.1831	52.30 115.32
LM761649D	LM761610	1.5 0.06	361.0 14.21	3.3 0.13	432.0 17.01	2200.4	322.3	0.1873	51.91 114.44
LM961548D	LM961511	1.5 0.06	362.0 14.25	3.3 0.13	423.0 16.65	2281.5	300.4	0.2146	55.81 123.04
EE161362D	161850	1.5 0.06	368.0 14.49	6.4 0.25	445.0 17.52	1730.8	299.6	0.1741	45.81 101.01
EE161362D	161900	1.5 0.06	368.0 14.49	6.4 0.25	451.0 17.76	1730.8	299.6	0.1741	51.47 113.46
EE161362D	161925	1.5 0.06	368.0 14.49	6.4 0.25	453.0 17.83	1730.8	299.6	0.1741	54.35 119.81

<sup>(4)</sup>These maximum fillet radii will be cleared by bearing corners.  
NOTE: For spacer configuration information, contact your Timken engineer.

# TAPERED ROLLER BEARINGS

## DOUBLE-ROW • TYPE TDI

### TYPE TDI



Bearing Dimensions				Load Ratings							
Bore d	O.D. D	Width T	Double Inner Ring Width B	Dynamic <sup>(1)</sup>				Dynamic <sup>(3)</sup>			
				C <sub>1(2)</sub>	e	Y <sub>1</sub>	Y <sub>2</sub>	C <sub>90</sub>	C <sub>a90</sub>	C <sub>90(2)</sub>	K
mm in.	mm in.	mm in.	mm in.	N lbf				N lbf	N lbf	N lbf	
346.075 13.6250	488.950 19.2500	174.625 6.8750	174.625 6.8750	3010000 676000	0.3	2.0	3.0	448000 101000	257000 57700	780000 175000	1.74
347.662 13.6875	469.900 18.5000	138.112 5.4375	138.112 5.4375	2730000 614000	0.3	2.0	3.0	406000 91400	231000 52000	708000 159000	1.76
355.600 14.0000	444.500 17.5000	112.712 4.4375	114.300 4.5000	1280000 287000	0.3	2.2	3.3	190000 42700	100000 22500	331000 74400	1.90
355.600 14.0000	457.200 18.0000	120.650 4.7500	120.650 4.7500	1640000 368000	0.3	2.1	3.2	244000 54900	133000 29900	425000 95500	1.83
355.600 14.0000	458.470 18.0500	120.650 4.7500	120.650 4.7500	1640000 368000	0.3	2.1	3.2	244000 54900	133000 29900	425000 95500	1.83
355.600 14.0000	482.600 19.0000	133.350 5.2500	128.588 5.0625	1870000 420000	0.5	1.4	2.1	278000 62500	225000 50600	484000 109000	1.24
355.600 14.0000	488.950 19.2500	153.988 6.0625	153.988 6.0625	2630000 591000	0.3	2.0	3.0	391000 88000	223000 50100	681000 153000	1.76
355.600 14.0000	501.650 19.7500	127.000 5.0000	111.125 4.3750	1830000 412000	0.4	1.5	2.3	273000 61300	206000 46200	475000 107000	1.33
355.600 14.0000	514.350 20.2500	127.000 5.0000	111.125 4.3750	1830000 412000	0.4	1.5	2.3	273000 61300	206000 46200	475000 107000	1.33
356.387 14.0310	482.600 19.0000	104.775 4.1250	101.600 4.0000	954000 214000	0.5	1.4	2.0	142000 31900	122000 27400	247000 55600	1.17
368.300 14.5000	523.875 20.6250	185.738 7.3125	185.738 7.3125	3960000 890000	0.3	2.0	3.0	589000 132000	335000 75400	1030000 231000	1.76
368.300 14.5000	596.900 23.5000	165.100 6.5000	158.750 6.2500	3090000 694000	0.4	1.6	2.4	460000 103000	326000 73400	801000 180000	1.41
368.300 14.5000	609.600 24.0000	254.000 10.0000	279.400 11.0000	5170000 1160000	0.4	1.9	2.8	770000 173000	470000 106000	1340000 301000	1.64
368.300 14.5000	622.300 24.5000	254.000 10.0000	279.400 11.0000	5170000 1160000	0.4	1.9	2.8	770000 173000	470000 106000	1340000 301000	1.64
374.574 14.7470	546.100 21.5000	193.675 7.6250	193.675 7.6250	4290000 963000	0.3	2.0	3.0	638000 143000	363000 81700	1110000 250000	1.76
374.650 14.7500	501.650 19.7500	127.000 5.0000	117.475 4.6250	1830000 412000	0.4	1.5	2.3	273000 61300	206000 46200	475000 107000	1.33
374.650 14.7500	501.650 19.7500	130.175 5.1250	120.650 4.7500	1860000 417000	0.5	1.4	2.1	276000 62100	224000 50300	481000 108000	1.24

<sup>(1)</sup>Based on 1 x 10<sup>6</sup> revolutions L<sub>10</sub> life, for the ISO life-calculation method. C<sub>1(2)</sub> is the double-row radial value.

<sup>(2)</sup>Consult your Timken engineer for instructions on use or review the Timken Engineering Manual on [timken.com/catalogs](http://timken.com/catalogs).

<sup>(3)</sup>Based on 90 x 10<sup>6</sup> revolutions L<sub>10</sub> life, for The Timken Company life-calculation method. C<sub>90</sub> and C<sub>a90</sub> are radial and thrust values for a single row. C<sub>90(2)</sub> is the double-row radial value.

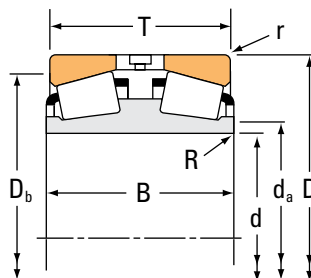
Part Number		Dimensions				Geometry Factors			Bearing Weight
Inner	Outer	Shaft		Housing		G <sub>1</sub>	G <sub>2</sub>	C <sub>g</sub>	
		Max Shaft Fillet Radius R <sup>(4)</sup>	Backing Shoulder Dia. d <sub>a</sub>	Max Housing Fillet Radius r <sup>(4)</sup>	Backing Shoulder Dia. D <sub>b</sub>				
		mm in.	mm in.	mm in.	mm in.				kg lbs.
HM262749D	HM262710	3.3 0.13	371.0 14.61	3.3 0.13	456.0 17.95	3646.2	341.8	0.1999	110.26 243.09
M262449D	M262410	3.3 0.13	369.0 14.53	3.3 0.13	443.0 17.44	2968.5	408.3	0.1853	69.19 152.55
L163149D	L163110	1.5 0.06	370.0 14.57	3.3 0.13	422.0 16.61	3207.7	621.3	0.1838	40.80 89.95
LM263149D	LM263110	1.5 0.06	372.0 14.65	3.3 0.13	434.0 17.09	3094.1	470.9	0.1845	50.40 111.09
LM263149D	LM263112	1.5 0.06	372.0 14.65	3.3 0.13	435.0 17.13	3094.1	470.9	0.1845	51.16 112.79
LM763449D	LM763410	1.5 0.06	375.0 14.76	3.3 0.13	453.0 17.83	2495.3	327.3	0.1955	66.45 146.49
M263349D	M263310	1.5 0.06	374.0 14.72	3.3 0.13	459.0 18.07	3301.0	337.7	0.1924	87.63 193.15
EE231401D	231975	3.3 0.13	382.0 15.04	3.3 0.13	472.0 18.58	2386.0	366.8	0.1874	70.62 155.70
EE231401D	232025	3.3 0.13	382.0 15.04	3.3 0.13	478.0 18.82	2386.0	366.8	0.1874	78.56 173.17
EE161403D	161900	1.5 0.06	375.0 14.76	6.4 0.25	451.0 17.76	1730.8	299.6	0.1741	48.59 107.11
HM265049D	HM265010	3.3 0.13	394.0 15.50	6.4 0.25	487.0 19.17	4297.3	412.9	0.2106	131.80 290.56
EE181454D	182350	6.4 0.25	408.0 16.06	6.4 0.25	552.0 21.73	2961.8	271.9	0.1984	165.60 365.08
EE321146D	321240	3.3 0.13	404.0 15.91	6.4 0.25	555.0 21.85	4401.5	304.6	0.2173	301.00 663.61
EE321146D	321245	3.3 0.13	404.0 15.91	6.4 0.25	561.0 22.09	4401.5	304.6	0.2173	332.56 733.20
HM266445D	HM266410	3.3 0.13	404.0 15.91	6.4 0.25	507.0 19.96	4760.1	301.5	0.2178	159.35 351.30
EE231475D	231975	1.5 0.06	393.0 15.47	3.3 0.13	472.0 18.58	2386.0	366.8	0.1874	62.17 137.07
LM765149D	LM765110	1.5 0.06	393.0 15.47	3.3 0.13	472.0 18.58	2574.9	352.2	0.1972	66.95 147.60

<sup>(4)</sup>These maximum fillet radii will be cleared by bearing corners.  
NOTE: For spacer configuration information, contact your Timken engineer.

# TAPERED ROLLER BEARINGS

## DOUBLE-ROW • TYPE TDI

### TYPE TDI



Bearing Dimensions				Load Ratings							
Bore d	O.D. D	Width T	Double Inner Ring Width B	Dynamic <sup>(1)</sup>				Dynamic <sup>(3)</sup>			
				C <sub>1(2)</sub>	e	Y <sub>1</sub>	Y <sub>2</sub>	C <sub>90</sub>	C <sub>a90</sub>	C <sub>90(2)</sub>	K
mm in.	mm in.	mm in.	mm in.	N lbf				N lbf	N lbf	N lbf	
374.650 14.7500	514.350 20.2500	127.000 5.0000	117.475 4.6250	1830000 412000	0.4	1.5	2.3	273000 61300	206000 46200	475000 107000	1.33
384.175 15.1250	546.100 21.5000	193.675 7.6250	193.675 7.6250	3660000 823000	0.3	2.0	3.0	545000 123000	311000 69800	950000 213000	1.76
384.175 15.1250	546.100 21.5000	193.675 7.6250	193.675 7.6250	3950000 887000	0.3	2.0	3.0	588000 132000	335000 75200	1020000 230000	1.76
393.700 15.5000	546.100 21.5000	138.112 5.4375	138.112 5.4375	2280000 513000	0.5	1.4	2.1	340000 76400	276000 62000	592000 133000	1.23
393.700 15.5000	558.800 22.0000	119.062 4.6875	120.650 4.7500	1890000 425000	0.5	1.4	2.1	282000 63300	230000 51600	490000 110000	1.23
406.400 16.0000	546.100 21.5000	87.312 3.4375	138.112 5.4375	2450000 551000	0.5	1.4	2.1	365000 82100	296000 66600	636000 143000	1.23
406.400 16.0000	546.100 21.5000	141.288 5.5625	120.650 4.7500	1890000 425000	0.5	1.4	2.1	282000 63300	230000 51600	490000 110000	1.23
406.400 16.0000	558.800 22.0000	119.062 4.6875	120.650 4.7500	1890000 425000	0.5	1.4	2.1	282000 63300	230000 51600	490000 110000	1.23
406.400 16.0000	558.800 22.0000	123.825 4.8750	120.650 4.7500	1890000 425000	0.5	1.4	2.1	282000 63300	230000 51600	490000 110000	1.23
406.400 16.0000	574.675 22.6250	114.300 4.5000	114.300 4.5000	1930000 434000	0.5	1.4	2.0	287000 64600	245000 55000	500000 112000	1.17
406.400 16.0000	590.550 23.2500	193.675 7.6250	193.675 7.6250	4020000 903000	0.3	2.1	3.1	598000 135000	333000 74900	1040000 234000	1.80
406.400 16.0000	609.600 24.0000	157.162 6.1875	149.225 5.8750	3210000 721000	0.4	1.8	2.6	477000 107000	313000 70400	831000 187000	1.52
409.575 16.1250	546.100 21.5000	161.925 6.3750	161.925 6.3750	2940000 661000	0.4	1.6	2.4	438000 98500	313000 70400	763000 171000	1.40
415.925 16.3750	590.550 23.2500	209.550 8.2500	209.550 8.2500	4970000 1120000	0.3	2.0	3.0	740000 166000	421000 94800	1290000 290000	1.76
419.227 16.5050	736.448 28.9940	406.400 16.0000	406.400 16.0000	10500000 2350000	0.4	1.8	2.7	1560000 350000	996000 224000	2710000 610000	1.56
425.450 16.7500	685.698 26.9960	253.873 9.9950	253.873 9.9950	5450000 1230000	0.4	1.7	2.5	812000 183000	559000 126000	1410000 318000	1.45
431.800 17.0000	571.500 22.5000	133.350 5.2500	130.175 5.1250	2420000 543000	0.4	1.8	2.6	360000 80900	237000 53300	626000 141000	1.52

<sup>(1)</sup>Based on 1 x 10<sup>6</sup> revolutions L<sub>10</sub> life, for the ISO life-calculation method. C<sub>1(2)</sub> is the double-row radial value.

<sup>(2)</sup>Consult your Timken engineer for instructions on use or review the Timken Engineering Manual on [timken.com/catalogs](http://timken.com/catalogs).

<sup>(3)</sup>Based on 90 x 10<sup>6</sup> revolutions L<sub>10</sub> life, for The Timken Company life-calculation method. C<sub>90</sub> and C<sub>a90</sub> are radial and thrust values for a single row. C<sub>90(2)</sub> is the double-row radial value.



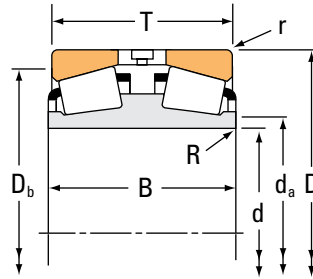
Part Number		Dimensions				Geometry Factors			Bearing Weight
Inner	Outer	Shaft		Housing		G <sub>1</sub>	G <sub>2</sub>	C <sub>g</sub>	
		Max Shaft Fillet Radius R <sup>(4)</sup>	Backing Shoulder Dia. d <sub>a</sub>	Max Housing Fillet Radius r <sup>(4)</sup>	Backing Shoulder Dia. D <sub>b</sub>				kg lbs.
		mm in.	mm in.	mm in.	mm in.				
EE231475D	232025	1.5 0.06	393.0 15.47	3.3 0.13	478.0 18.82	2386.0	366.8	0.1874	70.11 154.54
HM266449D	HM266410	3.3 0.13	411.0 16.18	6.4 0.25	507.0 19.96	4760.1	301.5	0.2178	154.73 341.11
HM266448D	HM266410	3.3 0.13	411.0 16.18	6.4 0.25	507.0 19.96	4383.4	278.7	0.2116	147.14 324.40
LM767745D	LM767710	1.5 0.06	418.0 16.46	6.4 0.25	510.0 20.08	3387.8	464.9	0.2163	98.85 217.93
EE234157D	234220	3.3 0.13	420.0 16.54	6.4 0.25	516.0 20.31	2782.9	448.6	0.2018	95.27 210.04
LM767748D	LM767710	1.5 0.06	427.0 16.81	6.4 0.25	510.0 20.08	3640.2	497.8	0.2218	94.87 209.18
EE234161D	234215	1.5 0.06	425.0 16.73	6.4 0.25	504.0 19.84	2782.9	448.6	0.2018	82.24 181.31
EE234161D	234220	1.5 0.06	425.0 16.73	6.4 0.25	516.0 20.31	2782.9	448.6	0.2018	81.08 178.77
EE234161D	234220	1.5 0.06	425.0 16.73	6.4 0.25	516.0 20.31	2782.9	448.6	0.2018	81.08 193.39
EE285161D	285226	3.3 0.13	435.0 17.13	3.3 0.13	534.0 21.02	3036.6	478.1	0.2103	97.72 215.42
EE833161XD	833232	3.3 0.13	435.0 17.13	6.4 0.25	549.0 21.61	4955.5	446.0	0.2186	180.03 396.92
EE911603D	912400	3.5 0.14	437.0 17.20	6.4 0.25	567.0 22.32	3251.1	349.1	0.1990	148.41 327.24
M667947D	M667911	1.5 0.06	431.0 16.97	6.4 0.25	510.0 20.08	4197.4	453.5	0.2235	105.61 232.85
M268748D	M268710	9.7 0.38	451.9 17.79	6.4 0.25	548.9 21.61	5754.9	420.9	0.2319	189.52 417.80
EE323166D	323290	6.4 0.25	477.3 18.79	6.4 0.25	657.0 25.87	7958.6	331.3	0.2699	770.95 1699.62
EE328167D	328269	6.4 0.25	469.0 18.46	6.4 0.25	624.0 24.57	5606.6	353.0	0.2443	376.93 831.03
EE239171D	239225	1.5 0.06	449.1 17.68	3.3 0.13	540.0 21.26	4003.6	563.3	0.2131	93.15 205.37

<sup>(4)</sup>These maximum fillet radii will be cleared by bearing corners.  
NOTE: For spacer configuration information, contact your Timken engineer.

# TAPERED ROLLER BEARINGS

## DOUBLE-ROW • TYPE TDI

### TYPE TDI



Bearing Dimensions				Load Ratings							
Bore d	O.D. D	Width T	Double Inner Ring Width B	Dynamic <sup>(1)</sup>				Dynamic <sup>(3)</sup>			
				C <sub>1(2)</sub>	e	Y <sub>1</sub>	Y <sub>2</sub>	C <sub>90</sub>	C <sub>a90</sub>	C <sub>90(2)</sub>	K
mm in.	mm in.	mm in.	mm in.	N lbf				N lbf	N lbf	N lbf	
431.800 17.0000	571.500 22.5000	133.350 5.2500	130.175 5.1250	2420000 543000	0.4	1.8	2.6	360000 80900	237000 53300	626000 141000	1.52
431.800 17.0000	635.000 25.0000	173.038 6.8125	173.038 6.8125	3680000 827000	0.3	2.1	3.1	548000 123000	301000 67700	953000 214000	1.82
431.800 17.0000	723.900 28.5000	419.100 16.5000	419.100 16.5000	10700000 2400000	0.3	2.3	3.4	1590000 358000	807000 181000	2770000 623000	1.97
431.902 17.0040	685.698 26.9960	253.873 9.9950	253.873 9.9950	5450000 1230000	0.4	1.7	2.5	812000 183000	559000 126000	1410000 318000	1.45
431.902 17.0040	685.698 26.9960	330.200 13.0000	330.200 13.0000	8080000 1820000	0.3	2.1	3.1	1200000 270000	669000 150000	2090000 471000	1.80
432.003 17.0080	609.524 23.9970	152.400 6.0000	152.400 6.0000	2990000 673000	0.4	1.9	2.9	446000 100000	265000 59600	776000 175000	1.68
447.675 17.6250	635.000 25.0000	223.838 8.8125	223.838 8.8125	5700000 1280000	0.3	2.0	3.0	849000 191000	484000 109000	1480000 332000	1.76
449.948 17.7145	594.949 23.4232	178.000 7.0079	178.000 7.0079	3470000 780000	0.3	2.0	3.0	517000 116000	294000 66200	900000 202000	1.76
456.794 17.9840	761.873 29.9950	254.000 10.0000	254.000 10.0000	6180000 1390000	0.4	1.5	2.3	920000 207000	695000 156000	1600000 360000	1.32
457.073 17.9950	730.148 28.7460	203.200 8.0000	196.850 7.7500	4920000 1110000	0.4	1.7	2.6	733000 165000	492000 111000	1280000 287000	1.49
457.073 17.9950	749.300 29.5000	419.100 16.5000	412.750 16.2500	11000000 2480000	0.3	2.2	3.3	1640000 369000	858000 193000	2860000 643000	1.91
457.200 18.0000	596.900 23.5000	133.350 5.2500	130.175 5.1250	2460000 554000	0.4	1.7	2.5	367000 82400	254000 57100	639000 144000	1.44
457.200 18.0000	596.900 23.5000	136.525 5.3750	133.350 5.2500	2610000 587000	0.5	1.4	2.1	389000 87500	315000 70800	677000 152000	1.24
457.200 18.0000	660.400 26.0000	155.575 6.1250	155.575 6.1250	3070000 689000	0.4	1.8	2.7	457000 103000	292000 65700	795000 179000	1.56
457.200 18.0000	761.873 29.9950	215.900 8.5000	209.550 8.2500	6040000 1360000	0.3	2.1	3.2	900000 202000	491000 110000	1570000 352000	1.83
457.200 18.0000	812.800 32.0000	342.900 13.5000	342.900 13.5000	8610000 1940000	0.3	2.0	3.0	1280000 288000	738000 166000	2230000 502000	1.74
457.200 18.0000	863.498 33.9960	368.300 14.5000	368.300 14.5000	10800000 2420000	0.4	1.9	2.8	1600000 361000	989000 222000	2790000 628000	1.62

<sup>(1)</sup>Based on 1 x 10<sup>6</sup> revolutions L<sub>10</sub> life, for the ISO life-calculation method. C<sub>1(2)</sub> is the double-row radial value.

<sup>(2)</sup>Consult your Timken engineer for instructions on use or review the Timken Engineering Manual on [timken.com/catalogs](http://timken.com/catalogs).

<sup>(3)</sup>Based on 90 x 10<sup>6</sup> revolutions L<sub>10</sub> life, for The Timken Company life-calculation method. C<sub>90</sub> and C<sub>a90</sub> are radial and thrust values for a single row. C<sub>90(2)</sub> is the double-row radial value.

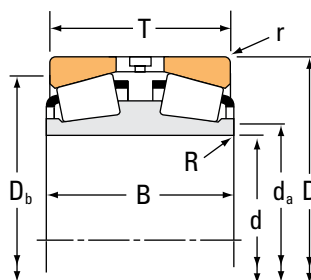
Part Number		Dimensions				Geometry Factors			Bearing Weight
Inner	Outer	Shaft		Housing		G <sub>1</sub>	G <sub>2</sub>	C <sub>g</sub>	
		Max Shaft Fillet Radius R <sup>(4)</sup>	Backing Shoulder Dia. d <sub>a</sub>	Max Housing Fillet Radius r <sup>(4)</sup>	Backing Shoulder Dia. D <sub>b</sub>				kg lbs.
		mm in.	mm in.	mm in.	mm in.				
EE239173D	239225	1.5 0.06	449.1 17.68	3.3 0.13	540.0 21.26	4003.6	563.3	0.2131	93.62 206.41
EE931170D	931250	6.4 0.25	468.1 18.43	6.4 0.25	591.1 23.27	4624.1	391.2	0.2117	187.65 413.69
NP710048	NP102973	3.3 0.13	478.0 18.82	8.4 0.33	669.0 26.34	9649.5	361.5	0.2667	725.86 1600.22
EE328172D	328269	6.4 0.25	474.0 18.66	6.4 0.25	624.0 24.57	5606.6	353.0	0.2443	368.28 811.97
EE650171D	650270	5.0 0.20	479.0 18.86	6.4 0.25	627.0 24.69	7668.4	341.3	0.2542	487.03 1073.71
EE736173D	736238	3.5 0.14	459.0 18.07	6.4 0.25	570.0 22.44	4176.8	536.6	0.2096	138.77 305.93
M270749D	M270710	3.3 0.13	478.0 18.82	6.4 0.25	591.0 23.27	6865.6	481.9	0.2458	240.64 530.52
M270449DA	M270410	3.0 0.12	474.0 18.66	6.0 0.24	561.0 22.09	6018.9	562.1	0.2343	137.77 303.74
EE425176D	425299	3.3 0.13	500.0 19.69	6.4 0.25	696.0 27.40	5741.9	326.2	0.2529	463.65 1022.16
EE671798D	672873	1.5 0.06	491.0 19.33	6.4 0.25	675.0 26.57	4968.3	343.4	0.2315	331.41 730.64
EE925179D	925295	3.3 0.13	504.0 19.84	6.4 0.25	681.0 26.81	10435.5	423.0	0.2765	769.11 1695.62
EE244181D	244235	1.5 0.06	478.0 18.82	3.3 0.13	567.0 22.32	4411.8	627.1	0.2233	92.20 203.25
L770849D	L770810	1.5 0.06	478.0 18.82	3.3 0.13	567.0 22.32	3853.2	483.2	0.2247	95.00 209.46
EE737179D	737260	3.3 0.13	489.0 19.25	6.4 0.25	614.9 24.21	4809.1	573.4	0.2247	173.98 383.56
EE423181D	423300	6.4 0.25	507.0 19.96	6.4 0.25	708.0 27.87	6167.6	368.4	0.2325	413.25 911.07
EE525183D	525320	9.7 0.38	522.0 20.55	6.4 0.25	741.0 29.17	7501.7	378.4	0.2535	741.07 1633.68
EE480181D	480340	6.4 0.25	516.0 20.31	6.4 0.25	780.0 30.71	7384.2	343.1	0.2575	978.97 2158.21

<sup>(4)</sup>These maximum fillet radii will be cleared by bearing corners.  
NOTE: For spacer configuration information, contact your Timken engineer.

# TAPERED ROLLER BEARINGS

## DOUBLE-ROW • TYPE TDI

### TYPE TDI



Bearing Dimensions				Load Ratings							
Bore d	O.D. D	Width T	Double Inner Ring Width B	Dynamic <sup>(1)</sup>				Dynamic <sup>(3)</sup>			
				C <sub>1(2)</sub>	e	Factors <sup>(2)</sup> Y <sub>1</sub>	Y <sub>2</sub>	C <sub>90</sub>	C <sub>a90</sub>	C <sub>90(2)</sub>	Factors <sup>(2)</sup> K
mm in.	mm in.	mm in.	mm in.	N lbf				N lbf	N lbf	N lbf	
464.000 18.2677	615.000 24.2126	150.000 5.9055	136.000 5.3543	2710000 610000	0.8	0.9	1.3	404000 90800	551000 124000	703000 158000	0.73
479.425 18.8750	679.450 26.7500	238.125 9.3750	238.125 9.3750	6500000 1460000	0.3	2.0	3.0	968000 218000	551000 124000	1680000 379000	1.76
482.600 19.0000	615.950 24.2500	158.750 6.2500	158.750 6.2500	2950000 662000	0.3	2.0	3.0	439000 98600	250000 56100	764000 172000	1.76
488.950 19.2500	660.400 26.0000	171.450 6.7500	174.625 6.8750	4130000 928000	0.3	2.2	3.3	614000 138000	323000 72600	1070000 240000	1.90
489.026 19.2530	634.873 24.9950	152.400 6.0000	152.400 6.0000	2560000 574000	0.3	2.0	2.9	380000 85500	223000 50200	662000 149000	1.70
500.000 19.6850	660.000 25.9843	160.000 6.2992	160.000 6.2992	3090000 694000	0.7	0.9	1.4	460000 103000	583000 131000	800000 180000	0.79
501.650 19.7500	711.200 28.0000	250.825 9.8750	250.825 9.8750	6150000 1380000	0.3	2.0	3.0	916000 206000	521000 117000	1590000 358000	1.76
505.181 19.8890	838.200 33.0000	266.700 10.5000	266.700 10.5000	6290000 1410000	0.5	1.4	2.1	936000 210000	769000 173000	1630000 366000	1.22
508.000 20.0000	762.000 30.0000	219.075 8.6250	219.075 8.6250	5360000 1210000	0.4	1.8	2.7	799000 180000	519000 117000	1390000 313000	1.54
514.350 20.2500	673.100 26.5000	203.200 8.0000	203.200 8.0000	4130000 928000	0.3	2.1	3.2	615000 138000	336000 75400	1070000 241000	1.83
519.112 20.4375	736.600 29.0000	258.762 10.1875	258.762 10.1875	6570000 1480000	0.3	2.0	3.0	978000 220000	557000 125000	1700000 383000	1.76
519.112 20.4375	736.600 29.0000	258.762 10.1875	258.762 10.1875	6570000 1480000	0.3	2.0	3.0	978000 220000	557000 125000	1700000 383000	1.76
536.575 21.1250	761.873 29.9950	269.875 10.6250	269.875 10.6250	6980000 1570000	0.3	2.0	3.0	1040000 234000	592000 133000	1810000 407000	1.76
536.575 21.1250	761.873 29.9950	269.875 10.6250	269.875 10.6250	6980000 1570000	0.3	2.0	3.0	1040000 234000	592000 133000	1810000 407000	1.76
539.750 21.2500	784.225 30.8750	165.100 6.5000	161.925 6.3750	3770000 848000	0.5	1.4	2.1	561000 126000	457000 103000	977000 220000	1.23
558.673 21.9950	901.573 35.4950	457.200 18.0000	442.912 17.4375	15700000 3540000	0.4	1.9	2.8	2340000 526000	1460000 329000	4080000 917000	1.60
558.800 22.0000	660.400 26.0000	95.250 3.7500	92.075 3.6250	1360000 305000	0.6	1.2	1.8	202000 45400	189000 42400	352000 79000	1.07

<sup>(1)</sup>Based on 1 x 10<sup>6</sup> revolutions L<sub>10</sub> life, for the ISO life-calculation method. C<sub>1(2)</sub> is the double-row radial value.

<sup>(2)</sup>Consult your Timken engineer for instructions on use or review the Timken Engineering Manual on [timken.com/catalogs](http://timken.com/catalogs).

<sup>(3)</sup>Based on 90 x 10<sup>6</sup> revolutions L<sub>10</sub> life, for The Timken Company life-calculation method. C<sub>90</sub> and C<sub>a90</sub> are radial and thrust values for a single row. C<sub>90(2)</sub> is the double-row radial value.

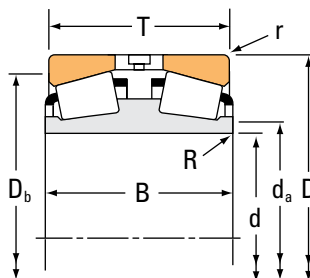
Part Number		Dimensions				Geometry Factors			Bearing Weight
Inner	Outer	Shaft		Housing		G <sub>1</sub>	G <sub>2</sub>	C <sub>g</sub>	
		Max Shaft Fillet Radius R <sup>(4)</sup>	Backing Shoulder Dia. d <sub>a</sub>	Max Housing Fillet Radius r <sup>(4)</sup>	Backing Shoulder Dia. D <sub>b</sub>				kg lbs.
		mm in.	mm in.	mm in.	mm in.				
NP609202	NP357825	2.0 0.08	490.0 19.29	4.0 0.16	573.0 22.56	4033.4	478.0	0.2668	116.36 256.54
M272749D	M272710	3.3 0.13	510.0 20.08	6.4 0.25	633.0 24.92	8110.8	508.6	0.2598	286.50 631.63
LM272249D	LM272210	3.3 0.13	504.0 19.84	6.4 0.25	585.0 23.03	6037.2	665.8	0.2333	115.10 253.77
EE640193D	640260	3.3 0.13	516.0 20.31	6.4 0.25	624.0 24.57	6322.4	601.7	0.2310	168.17 370.70
EE243193D	243250	3.3 0.13	516.0 20.31	3.3 0.13	603.0 23.74	6057.3	726.6	0.2350	126.03 277.85
NP025753	NP652808	3.5 0.14	525.0 20.67	5.0 0.20	615.0 24.21	4951.9	567.5	0.2797	144.99 319.67
M274149D	M274110	3.3 0.13	534.0 21.02	6.4 0.25	663.0 26.10	9019.6	560.7	0.2690	339.24 747.88
EE426198D	426330	6.4 0.25	555.0 21.85	9.7 0.38	759.0 29.88	6651.9	435.2	0.2722	600.54 1323.96
EE531201D	531300	6.4 0.25	550.7 21.68	6.4 0.25	710.9 27.99	6784.6	473.8	0.2541	345.54 761.84
LM274449D	LM274410	3.3 0.13	540.0 21.26	6.4 0.25	636.0 25.04	8252.3	802.0	0.2561	321.70 709.11
M275349D	M275310	3.3 0.13	552.0 21.73	6.4 0.25	684.0 26.93	9814.6	651.6	0.2766	383.08 844.57
M275348D	M275310	3.3 0.13	552.0 21.73	6.4 0.25	684.0 26.93	9814.6	651.6	0.2766	381.64 841.40
M276449D	M276410	3.3 0.13	564.0 22.20	6.4 0.25	711.0 27.99	10625.0	614.5	0.2839	415.94 917.01
M276448D	M276410	3.3 0.13	564.0 22.20	6.4 0.25	711.0 27.99	10625.0	614.5	0.2839	415.91 916.95
EE522126D	523087	3.3 0.13	573.0 22.56	6.4 0.25	732.0 28.82	5013.3	457.2	0.2452	240.64 530.53
EE546220D	546355	6.4 0.25	621.0 24.45	12.7 0.50	816.0 32.13	14325.6	376.4	0.3250	1170.74 2581.03
LL876449D	LL876410	1.5 0.06	576.0 22.68	3.3 0.13	636.0 25.04	4668.3	1119.2	0.2467	54.75 120.67

<sup>(4)</sup>These maximum fillet radii will be cleared by bearing corners.  
NOTE: For spacer configuration information, contact your Timken engineer.

# TAPERED ROLLER BEARINGS

## DOUBLE-ROW • TYPE TDI

### TYPE TDI



Bearing Dimensions				Load Ratings							
Bore d	O.D. D	Width T	Double Inner Ring Width B	Dynamic <sup>(1)</sup>				Dynamic <sup>(3)</sup>			
				C <sub>1(2)</sub>	e	Y <sub>1</sub>	Y <sub>2</sub>	C <sub>90</sub>	C <sub>a90</sub>	C <sub>90(2)</sub>	K
mm in.	mm in.	mm in.	mm in.	N lbf				N lbf	N lbf	N lbf	
558.800 22.0000	736.600 29.0000	155.575 6.1250	155.575 6.1250	3600000 810000	0.3	2.0	2.9	536000 121000	315000 70700	934000 210000	1.70
558.800 22.0000	736.600 29.0000	196.850 7.7500	196.850 7.7500	4480000 1010000	0.4	2.0	2.9	667000 150000	395000 88800	1160000 261000	1.69
571.500 22.5000	812.800 32.0000	285.750 11.2500	285.750 11.2500	7890000 1770000	0.3	2.0	3.0	1180000 264000	669000 150000	2050000 460000	1.76
585.788 23.0625	771.525 30.3750	230.188 9.0625	230.188 9.0625	5730000 1290000	0.3	2.0	3.0	853000 192000	486000 109000	1490000 334000	1.76
585.788 23.0625	771.525 30.3750	230.188 9.0625	230.188 9.0625	5730000 1290000	0.3	2.0	3.0	853000 192000	486000 109000	1490000 334000	1.76
600.000 23.6220	1170.000 46.0630	510.000 20.0787	510.000 20.0787	20500000 4610000	0.5	1.4	2.0	3050000 687000	2590000 581000	5320000 1200000	1.18
609.600 24.0000	787.400 31.0000	171.450 6.7500	171.450 6.7500	4550000 1020000	0.4	1.8	2.7	677000 152000	430000 96600	1180000 265000	1.58
609.600 24.0000	863.600 34.0000	317.500 12.5000	317.500 12.5000	10500000 2370000	0.3	2.0	3.0	1570000 353000	893000 201000	2730000 614000	1.76
630.000 24.8031	1030.000 40.5512	315.000 12.4016	315.000 12.4016	12200000 2750000	0.5	1.5	2.2	1820000 409000	1410000 316000	3170000 713000	1.30
635.000 25.0000	901.700 35.5000	317.500 12.5000	317.500 12.5000	9560000 2150000	0.3	2.0	3.0	1420000 320000	810000 182000	2480000 557000	1.76
635.000 25.0000	939.800 37.0000	304.800 12.0000	304.800 12.0000	7950000 1790000	0.6	1.2	1.8	1180000 266000	1170000 262000	2060000 463000	1.01
647.700 25.5000	1028.700 40.5000	279.400 11.0000	273.050 10.7500	9760000 2190000	0.3	2.2	3.2	1450000 327000	782000 176000	2530000 569000	1.86
660.400 26.0000	812.800 32.0000	176.212 6.9375	176.212 6.9375	4760000 1070000	0.3	2.0	3.0	709000 159000	404000 90700	1230000 278000	1.76
660.400 26.0000	1066.800 42.0000	321.470 12.6563	311.942 12.2812	11400000 2560000	0.3	2.2	3.2	1690000 381000	898000 202000	2950000 663000	1.89
660.400 26.0000	1104.900 43.5000	571.500 22.5000	571.500 22.5000	14500000 3260000	0.3	2.0	2.9	2160000 486000	1280000 287000	3760000 846000	1.69
682.625 26.8750	965.200 38.0000	338.138 13.3125	338.138 13.3125	10900000 2440000	0.3	2.0	3.0	1620000 364000	921000 207000	2820000 634000	1.76
708.025 27.8750	930.275 36.6250	273.050 10.7500	273.050 10.7500	8060000 1810000	0.3	2.0	3.0	1200000 270000	684000 154000	2090000 470000	1.76

<sup>(1)</sup>Based on 1 x 10<sup>6</sup> revolutions L<sub>10</sub> life, for the ISO life-calculation method. C<sub>1(2)</sub> is the double-row radial value.

<sup>(2)</sup>Consult your Timken engineer for instructions on use or review the Timken Engineering Manual on [timken.com/catalogs](http://timken.com/catalogs).

<sup>(3)</sup>Based on 90 x 10<sup>6</sup> revolutions L<sub>10</sub> life, for The Timken Company life-calculation method. C<sub>90</sub> and C<sub>a90</sub> are radial and thrust values for a single row. C<sub>90(2)</sub> is the double-row radial value.

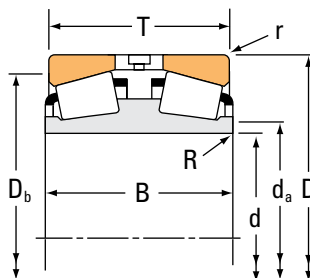
Part Number		Dimensions				Geometry Factors			Bearing Weight
Inner	Outer	Shaft		Housing		G <sub>1</sub>	G <sub>2</sub>	C <sub>g</sub>	
		Max Shaft Fillet Radius R <sup>(4)</sup>	Backing Shoulder Dia. d <sub>a</sub>	Max Housing Fillet Radius r <sup>(4)</sup>	Backing Shoulder Dia. D <sub>b</sub>				kg lbs.
		mm in.	mm in.	mm in.	mm in.				
EE843221D	843290	3.3 0.13	585.0 23.03	6.4 0.25	699.0 27.52	7097.5	714.8	0.2478	177.96 392.34
LM377449D	LM377410	3.3 0.13	588.0 23.15	6.4 0.25	696.0 27.40	9314.8	907.6	0.2735	237.01 522.50
M278749D	M278710	3.3 0.13	609.0 23.98	6.4 0.25	756.0 29.76	12425.1	669.4	0.2990	489.64 1079.48
LM278849D	LM278810	3.3 0.13	615.0 24.21	6.4 0.25	726.0 28.58	11553.5	930.7	0.2906	302.98 667.96
LM278848D	LM278810	6.4 0.25	616.0 24.25	6.4 0.25	726.0 28.58	11553.5	930.7	0.2906	302.76 667.48
NP726553	NP137813	10.0 0.39	708.0 27.87	10.0 0.39	1040.0 40.94	15142.1	383.3	0.3624	2575.44 5674.87
EE649241D	649310	3.3 0.13	636.0 25.04	6.4 0.25	747.0 29.41	9384.8	930.0	0.2790	217.30 479.00
M280349D	M280310	3.3 0.13	648.0 25.51	6.4 0.25	807.0 31.77	14433.6	688.8	0.3143	608.49 1341.48
NP689200	NP360973	7.5 0.30	690.0 27.17	8.0 0.32	945.0 37.20	11932.9	565.6	0.3241	1060.79 2338.55
M281049D	M281010	3.3 0.13	675.0 26.57	6.4 0.25	843.0 33.19	15906.3	881.4	0.3244	686.09 1512.56
LM881245D	LM881214	3.3 0.13	684.0 26.93	6.4 0.25	873.0 34.37	10936.2	636.2	0.3398	738.59 1628.30
EE424257D	424405	11.0 0.43	713.5 28.09	6.4 0.25	960.0 37.80	12039.2	632.2	0.2880	863.66 1904.05
L281149D	L281110	3.3 0.13	682.8 26.88	6.4 0.25	777.0 30.59	12635.6	984.9	0.2968	206.17 454.56
EE428262D	428420	6.4 0.25	717.0 28.23	6.4 0.25	990.0 38.98	13917.6	590.9	0.3012	1101.53 2428.47
EE627260D	627435	12.7 0.50	740.0 29.13	3.3 0.13	1010.0 39.76	18464.3	651.3	0.3447	2038.55 4494.20
M282249D	M282210	3.3 0.13	723.0 28.46	6.4 0.25	900.0 35.43	18773.0	843.1	0.3426	843.10 1858.77
LM282549D	LM282510	3.3 0.13	741.0 29.17	6.4 0.25	879.0 34.61	18246.3	1087.0	0.3379	519.26 1144.78

<sup>(4)</sup>These maximum fillet radii will be cleared by bearing corners.  
NOTE: For spacer configuration information, contact your Timken engineer.

# TAPERED ROLLER BEARINGS

## DOUBLE-ROW TYPE TDI

### TYPE TDI



Bearing Dimensions				Load Ratings							
Bore d	O.D. D	Width T	Double Inner Ring Width B	Dynamic <sup>(1)</sup>				Dynamic <sup>(3)</sup>			
				C <sub>1(2)</sub>	e	Y <sub>1</sub>	Y <sub>2</sub>	C <sub>90</sub>	C <sub>a90</sub>	C <sub>90(2)</sub>	K
mm in.	mm in.	mm in.	mm in.	N lbf				N lbf	N lbf	N lbf	
711.200 28.0000	914.400 36.0000	149.225 5.8750	149.225 5.8750	4150000 934000	0.4	1.8	2.6	619000 139000	403000 90600	1080000 242000	1.54
730.250 28.7500	1035.050 40.7500	365.125 14.3750	365.125 14.3750	12400000 2790000	0.3	2.0	3.0	1850000 416000	1050000 237000	3220000 724000	1.76
749.300 29.5000	1066.800 42.0000	361.950 14.2500	349.250 13.7500	12400000 2790000	0.3	2.1	3.1	1850000 415000	1040000 234000	3220000 723000	1.77
749.300 29.5000	1181.100 46.5000	355.600 14.0000	355.600 14.0000	13000000 2920000	0.4	1.8	2.7	1930000 434000	1240000 278000	3360000 756000	1.56
762.000 30.0000	1079.500 42.5000	381.000 15.0000	381.000 15.0000	13400000 3010000	0.3	2.0	3.0	1990000 448000	1130000 255000	3470000 780000	1.76
779.925 30.7057	1219.873 48.0265	406.674 16.0108	406.674 16.0108	15500000 3480000	0.4	1.7	2.6	2310000 519000	1550000 347000	4020000 903000	1.49
787.400 31.0000	1219.200 48.0000	406.400 16.0000	406.400 16.0000	15500000 3480000	0.4	1.7	2.6	2310000 519000	1550000 347000	4020000 903000	1.49
825.500 32.5000	1168.400 46.0000	409.575 16.1250	409.575 16.1250	15600000 3500000	0.3	2.0	3.0	2320000 521000	1320000 297000	4040000 908000	1.76
840.000 33.0709	1040.000 40.9449	180.000 7.0866	170.000 6.6929	4260000 958000	0.4	1.5	2.3	634000 143000	475000 107000	1100000 248000	1.33
863.600 34.0000	1130.300 44.5000	323.850 12.7500	323.850 12.7500	11400000 2550000	0.3	2.0	3.0	1690000 380000	963000 216000	2940000 662000	1.76
863.600 34.0000	1219.200 48.0000	438.150 17.2500	425.450 16.7500	16900000 3790000	0.3	2.0	3.0	2510000 565000	1430000 322000	4380000 984000	1.76
901.700 35.5000	1295.400 51.0000	450.850 17.7500	438.150 17.2500	19500000 4380000	0.3	2.0	3.0	2900000 653000	1670000 376000	5050000 1140000	1.74
938.212 36.9375	1270.000 50.0000	400.050 15.7500	400.050 15.7500	15900000 3570000	0.3	2.0	3.0	2360000 532000	1350000 303000	4120000 926000	1.76
939.800 37.0000	1333.500 52.5000	463.550 18.2500	463.550 18.2500	19900000 4480000	0.3	2.0	3.0	2970000 667000	1690000 379000	5160000 1160000	1.76
939.800 37.0000	1333.500 52.5000	463.550 18.2500	463.550 18.2500	19900000 4480000	0.3	2.0	3.0	2970000 667000	1690000 379000	5160000 1160000	1.76
1200.150 47.2500	1593.850 62.7500	482.600 19.0000	482.600 19.0000	23600000 5300000	0.3	2.0	3.0	3510000 789000	2000000 449000	6110000 1370000	1.76

<sup>(1)</sup>Based on 1 x 10<sup>6</sup> revolutions L<sub>10</sub> life, for the ISO life-calculation method. C<sub>1(2)</sub> is the double-row radial value.

<sup>(2)</sup>Consult your Timken engineer for instructions on use or review the Timken Engineering Manual on [timken.com/catalogs](http://timken.com/catalogs).

<sup>(3)</sup>Based on 90 x 10<sup>6</sup> revolutions L<sub>10</sub> life, for The Timken Company life-calculation method. C<sub>90</sub> and C<sub>a90</sub> are radial and thrust values for a single row. C<sub>90(2)</sub> is the double-row radial value.



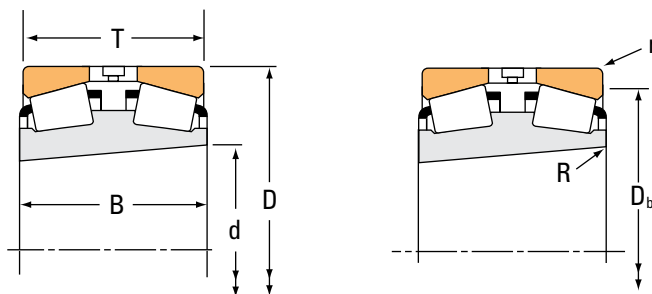
Part Number		Dimensions				Geometry Factors			Bearing Weight
Inner	Outer	Shaft		Housing		G <sub>1</sub>	G <sub>2</sub>	C <sub>g</sub>	
		Max Shaft Fillet Radius R <sup>(4)</sup>	Backing Shoulder Dia. d <sub>a</sub>	Max Housing Fillet Radius r <sup>(4)</sup>	Backing Shoulder Dia. D <sub>b</sub>				kg lbs.
		mm in.	mm in.	mm in.	mm in.				
EE755281D	755360	3.3 0.13	744.0 29.29	6.4 0.25	873.0 34.37	11122.5	1282.2	0.2952	247.94 546.60
M283449D	M283410	3.3 0.13	774.0 30.47	6.4 0.25	966.0 38.03	22247.2	891.2	0.3623	1031.10 2273.18
EE325296D	325420	9.5 0.37	806.5 31.75	12.7 0.50	996.0 39.21	21246.2	980.3	0.3551	1054.26 2324.28
EE690296D	690465	6.4 0.25	813.0 32.01	12.7 0.50	1085.0 42.72	19196.6	776.6	0.3569	1449.65 3195.93
M284249D	M284210	4.8 0.19	810.0 31.89	12.7 0.50	1005.0 39.57	24517.9	978.3	0.3741	1176.35 2593.38
EE631307D	631484	6.4 0.25	849.0 33.43	12.7 0.50	1125.0 44.29	24096.1	871.4	0.3916	1875.04 4133.58
EE631311D	631480	6.4 0.25	852.0 33.54	12.7 0.50	1125.0 44.29	24096.1	871.4	0.3916	1758.20 3876.07
M285848D	M285810	4.8 0.19	879.0 34.61	12.7 0.50	1085.0 42.72	29774.1	1207.4	0.3989	1478.41 3259.34
NP385417	NP439444	6.0 0.24	876.0 34.49	6.4 0.25	996.0 39.21	14184.2	1690.0	0.3333	315.36 695.25
LM286249D	LM286210	4.8 0.19	906.0 35.67	12.7 0.50	1065.0 41.93	28956.1	1086.1	0.3933	897.71 1979.10
EE547341D	547480	4.8 0.19	918.0 36.14	12.7 0.50	1135.0 44.69	33010.2	940.9	0.4127	1653.01 3644.25
EE634356D	634510	4.8 0.19	960.0 37.80	12.7 0.50	1205.0 47.44	35828.3	1141.4	0.4256	2034.61 4485.59
LM287649D	LM287610	4.8 0.19	990.0 38.98	12.7 0.50	1190.0 46.85	37220.5	1611.3	0.4283	1544.70 3405.44
LM287849D	LM287810	4.8 0.19	999.0 39.33	12.7 0.50	1240.0 48.82	40833.7	1438.6	0.4427	2190.95 4830.24
LM287849AD	LM287810	4.8 0.19	999.0 39.33	12.7 0.50	1240.0 48.82	40833.7	1438.6	0.4427	2183.29 4813.36
LM288949D	LM288910	4.8 0.19	1260.0 49.61	12.7 0.50	1500.0 59.06	66115.7	2354.8	0.5174	2744.57 6050.73

<sup>(4)</sup>These maximum fillet radii will be cleared by bearing corners.  
NOTE: For spacer configuration information, contact your Timken engineer.

# TAPERED ROLLER BEARINGS

## DOUBLE-ROW • TYPE TDIT

### TYPE TDIT



Bearing Dimensions					Load Ratings							
Bore d	Taper	O.D. D	Width T	Double Inner Ring Width B	Dynamic <sup>(1)</sup>				Dynamic <sup>(3)</sup>			
					C <sub>1(2)</sub>	e	Y <sub>1</sub>	Y <sub>2</sub>	C <sub>90</sub>	C <sub>a90</sub>	C <sub>90(2)</sub>	K
mm in.		mm in.	mm in.	mm in.	N lbf				N lbf	N lbf	N lbf	
37.037 1.4581	1:19.2	72.000 2.8346	39.096 1.5392	38.100 1.5000	83400 18700	0.44	1.52	2.26	12400 2790	9440 2120	21600 4860	1.31
100.211 3.9453	1:19.2	168.275 6.6250	95.250 3.7500	95.250 3.7500	435000 97800	0.47	1.43	2.14	64800 14600	52200 11700	113000 25400	1.24
101.600 4.0000	1:12	190.500 7.5000	117.475 4.6250	127.000 5.0000	878000 197000	0.33	2.02	3.00	131000 29400	74900 16800	228000 51100	1.74
115.888 4.5625	1:19.2	190.500 7.5000	107.950 4.2500	111.125 4.3750	598000 134000	0.42	1.62	2.42	89000 20000	63400 14300	155000 34800	1.40
206.375 8.1250	1:12	336.550 13.2500	180.975 7.1250	184.150 7.2500	2230000 501000	0.33	2.03	3.02	332000 74600	189000 42500	578000 130000	1.76
209.550 8.2500	1:12	317.500 12.5000	184.150 7.2500	184.150 7.2500	1200000 270000	0.52	1.29	1.92	179000 40200	160000 36100	312000 70100	1.12
214.973 8.4635	1:12	285.750 11.2500	92.075 3.6250	92.075 3.6250	707000 159000	0.48	1.40	2.09	105000 23700	86700 19500	183000 41200	1.21
219.075 8.6250	1:12	358.775 14.1250	196.850 7.7500	200.025 7.8750	2520000 566000	0.33	2.03	3.02	375000 84200	213000 47900	652000 147000	1.76
219.936 8.6589	1:12	314.325 12.3750	115.888 4.5625	123.822 4.8749	1210000 272000	0.33	2.03	3.02	180000 40500	103000 23100	314000 70500	1.76
234.950 9.2500	1:12	355.600 14.0000	165.100 6.5000	165.100 6.5000	1390000 312000	0.33	2.04	3.04	206000 46400	117000 26200	359000 80800	1.77
234.950 9.2500	1:12	355.600 14.0000	184.150 7.2500	184.150 7.2500	1390000 312000	0.33	2.04	3.04	206000 46400	117000 26200	359000 80800	1.77
243.152 9.5729	1:12	327.025 12.8750	92.075 3.6250	101.600 4.0000	987000 222000	0.32	2.10	3.13	147000 33000	80800 18200	256000 57500	1.82
252.412 9.9375	1:12	358.775 14.1250	130.175 5.1250	139.700 5.5000	1590000 358000	0.33	2.03	3.02	237000 53300	135000 30300	413000 92800	1.76
263.525 10.3750	1:12	400.050 15.7500	196.847 7.7499	192.088 7.5625	1440000 324000	0.39	1.71	2.55	215000 48200	145000 32600	374000 84000	1.48
266.700 10.5000	1:12	355.600 14.0000	107.950 4.2500	109.538 4.3125	1400000 315000	0.36	1.87	2.79	209000 46900	129000 28900	363000 81600	1.62
269.875 10.6250	1:12	381.000 15.0000	136.525 5.3750	136.525 5.3750	2000000 450000	0.33	2.03	3.02	298000 67000	170000 38100	519000 117000	1.76
280.000 11.0236	1:12	409.981 16.1410	206.375 8.1250	206.375 8.1250	1510000 340000	0.39	1.75	2.60	225000 50600	149000 33400	392000 88100	1.51

<sup>(1)</sup>Based on 1 x 10<sup>6</sup> revolutions L<sub>10</sub> life, for the ISO life-calculation method. C<sub>1(2)</sub> is the double-row radial value.

<sup>(2)</sup>Consult your Timken engineer for instructions on use or review the Timken Engineering Manual on [timken.com/catalogs](http://timken.com/catalogs).

<sup>(3)</sup>Based on 90 x 10<sup>6</sup> revolutions L<sub>10</sub> life, for The Timken Company life-calculation method. C<sub>90</sub> and C<sub>a90</sub> are radial and thrust values for a single row. C<sub>90(2)</sub> is the double-row radial value.

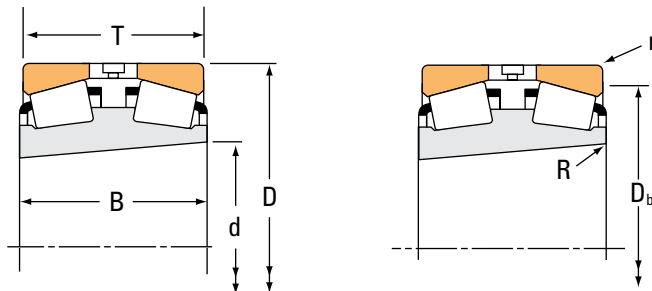
Part Number		Dimensions			Geometry Factors			Bearing Weight
Inner	Outer	Shaft	Housing		G <sub>1</sub>	G <sub>2</sub>	C <sub>g</sub>	
		Max Shaft Fillet Radius R <sup>(4)</sup>	Max Housing Fillet Radius r <sup>(4)</sup>	Backing Shoulder Dia. D <sub>b</sub>				kg
		mm in.	mm in.	mm in.				kg lbs.
19146TD	19283	0.8 0.03	1.5 0.06	63.0 2.48	17.5	11.5	0.0694	0.71 1.58
688TD	672	0.8 0.03	3.3 0.13	149.0 5.87	182.5	37.3	0.1056	8.38 18.46
HH221449TD	HH221410	0.8 0.03	3.3 0.13	171.0 6.73	265.6	28.4	0.1072	14.90 32.87
71457TD	71750	1.5 0.06	3.3 0.13	171.0 6.73	269.2	49.5	0.1156	12.08 26.63
H242649TD	H242610	1.5 0.06	3.3 0.13	306.0 12.05	1404.1	134.8	0.1465	49.31 108.74
93826TD	93125	1.5 0.06	3.3 0.13	286.0 11.26	912.5	126.1	0.1460	45.37 100.05
LM742746TD	LM742710	1.5 0.06	3.3 0.13	266.0 10.47	866.9	225.2	0.1388	16.00 35.25
H244848TD	H244810	1.5 0.06	6.4 0.25	323.0 12.72	1631.9	150.0	0.1540	83.34 183.74
M244246TD	M244210	1.5 0.06	3.3 0.13	293.0 11.54	1149.7	141.4	0.1360	31.68 69.85
EE130926TD	131400	1.5 0.06	1.5 0.06	329.0 12.95	1162.0	167.6	0.1358	51.55 113.66
EE130927TD	131400	1.5 0.06	1.5 0.06	329.0 12.95	1162.0	167.6	0.1358	54.20 119.51
LM247747TD	LM247710	1.5 0.06	3.3 0.13	310.0 12.20	1173.3	243.9	0.1345	23.70 52.24
M249746TD	M249710	1.5 0.06	3.3 0.13	335.0 13.19	1626.0	173.0	0.1526	45.97 101.36
EE221039TD	221575	1.5 0.06	6.4 0.25	366.0 14.41	1320.8	207.5	0.1497	70.69 155.85
LM451349TD	LM451310	1.5 0.06	3.3 0.13	335.0 13.19	1554.1	212.2	0.1536	30.99 68.32
M252349TD	M252310	1.5 0.06	3.3 0.13	356.0 14.02	1839.2	226.1	0.1588	50.82 112.03
EE128113TD	128161	3.3 0.13	3.3 0.13	379.0 14.92	1622.7	240.4	0.1592	78.15 172.27

<sup>(4)</sup>These maximum fillet radii will be cleared by bearing corners.  
NOTE: For spacer configuration information, contact your Timken engineer.

# TAPERED ROLLER BEARINGS

## DOUBLE-ROW • TYPE TDIT

### TYPE TDIT



Bearing Dimensions					Load Ratings							
Bore d	Taper	O.D. D	Width T	Double Inner Ring Width B	Dynamic <sup>(1)</sup>				Dynamic <sup>(3)</sup>			
					C <sub>1(2)</sub>	e	Y <sub>1</sub>	Y <sub>2</sub>	C <sub>90</sub>	C <sub>a90</sub>	C <sub>90(2)</sub>	K
mm in.		mm in.	mm in.	mm in.	N lbf				N lbf	N lbf	N lbf	
288.925 11.3750	1:12	406.400 16.0000	144.462 5.6875	144.462 5.6875	2070000 466000	0.34	2.00	2.97	308000 69300	179000 40100	537000 121000	1.73
295.275 11.6250	1:12	406.400 16.0000	203.200 8.0000	203.200 8.0000	1340000 301000	0.44	1.53	2.28	199000 44800	151000 33900	347000 78100	1.32
297.523 11.7135	1:12	422.275 16.6250	150.812 5.9375	160.338 6.3125	2260000 508000	0.34	2.00	2.99	336000 75600	194000 43600	586000 132000	1.73
303.212 11.9375	1:12	495.300 19.5000	263.525 10.3750	263.525 10.3750	5000000 1120000	0.33	2.03	3.02	744000 167000	423000 95200	1300000 291000	1.76
304.655 11.9943	1:12	438.048 17.2460	131.762 5.1875	131.762 5.1875	1880000 422000	0.33	2.04	3.03	280000 62900	159000 35700	487000 110000	1.76
316.111 12.4453	1:12	447.675 17.6250	157.429 6.1980	173.035 6.8124	2920000 656000	0.33	2.02	3.00	435000 97800	249000 56000	757000 170000	1.74
333.375 13.1250	1:12	523.875 20.6250	185.738 7.3125	185.738 7.3125	3960000 890000	0.33	2.03	3.02	589000 132000	335000 75400	1030000 231000	1.76
333.375 13.1250	1:12	469.900 18.5000	166.688 6.5625	166.688 6.5625	2780000 626000	0.33	2.02	3.00	415000 93200	238000 53400	722000 162000	1.74
346.075 13.6250	1:12	488.950 19.2500	174.625 6.8750	174.625 6.8750	3010000 676000	0.33	2.02	3.00	448000 101000	257000 57700	780000 175000	1.74
347.662 13.6875	1:12	469.900 18.5000	228.600 9.0000	228.600 9.0000	2490000 561000	0.33	2.03	3.02	372000 83500	212000 47500	647000 145000	1.76
349.250 13.7500	1:12	457.200 18.0000	120.650 4.7500	120.650 4.7500	1640000 368000	0.32	2.12	3.15	244000 54900	133000 29900	425000 95500	1.83
368.300 14.5000	1:12	523.875 20.6250	185.738 7.3125	185.738 7.3125	3960000 890000	0.33	2.03	3.02	589000 132000	335000 75400	1030000 231000	1.76
384.175 15.1250	1:12	546.100 21.5000	193.675 7.6250	193.675 7.6250	4290000 963000	0.33	2.03	3.02	638000 143000	363000 81700	1110000 250000	1.76
406.400 16.0000	1:12	590.550 23.2500	209.550 8.2500	209.550 8.2500	4970000 1120000	0.33	2.03	3.02	740000 166000	421000 94800	1290000 290000	1.76
415.925 16.3750	1:12	590.550 23.2500	209.550 8.2500	209.550 8.2500	4970000 1120000	0.33	2.03	3.02	740000 166000	421000 94800	1290000 290000	1.76
431.800 17.0000	1:12	571.500 22.5000	161.925 6.3750	161.925 6.3750	3320000 747000	0.44	1.54	2.29	495000 111000	371000 83500	862000 194000	1.33
447.675 17.6250	1:12	635.000 25.0000	223.838 8.8125	223.838 8.8125	5700000 1280000	0.33	2.03	3.02	849000 191000	484000 109000	1480000 332000	1.76

<sup>(1)</sup>Based on 1 x 10<sup>6</sup> revolutions L<sub>10</sub> life, for the ISO life-calculation method. C<sub>1(2)</sub> is the double-row radial value.

<sup>(2)</sup>Consult your Timken engineer for instructions on use or review the Timken Engineering Manual on [timken.com/catalogs](http://timken.com/catalogs).

<sup>(3)</sup>Based on 90 x 10<sup>6</sup> revolutions L<sub>10</sub> life, for The Timken Company life-calculation method. C<sub>90</sub> and C<sub>a90</sub> are radial and thrust values for a single row. C<sub>90(2)</sub> is the double-row radial value.

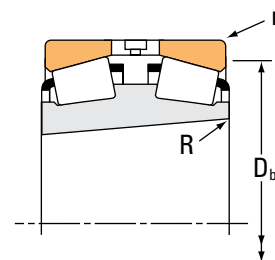
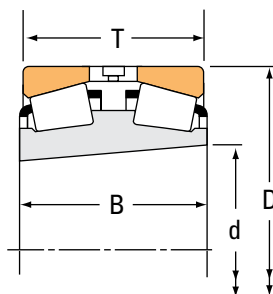
Part Number		Dimensions			Geometry Factors			Bearing Weight
Inner	Outer	Shaft	Housing		G <sub>1</sub>	G <sub>2</sub>	C <sub>g</sub>	
		Max Shaft Fillet Radius R <sup>(4)</sup>	Max Housing Fillet Radius r <sup>(4)</sup>	Backing Shoulder Dia. D <sub>b</sub>				kg lbs.
		mm in.	mm in.	mm in.				
M255449TD	M255410	3.3 0.13	3.3 0.13	379.0 14.92	2301.3	287.6	0.1722	62.40 137.58
LM757043TD	LM757010	1.5 0.06	3.3 0.13	380.0 14.96	1988.6	260.3	0.1775	72.69 160.24
HM256846TD	HM256810	3.3 0.13	3.3 0.13	394.0 15.51	2548.4	281.8	0.1779	76.21 168.01
HH258249TD	HH258210	3.3 0.13	6.4 0.25	448.0 17.64	3853.2	220.0	0.2048	224.54 495.02
NP868174	329172	7.6 0.30	3.3 0.13	410.0 16.14	2051.2	257.0	0.1638	65.38 144.13
HM259045TD	HM259010	3.0 0.12	3.3 0.13	418.0 16.46	2944.6	303.9	0.1863	89.79 197.96
HM265032TD	HM265010	3.3 0.13	6.4 0.25	487.0 19.17	4297.3	412.9	0.2106	166.14 366.28
HM261049TD	HM261010	3.3 0.13	3.3 0.13	439.0 17.28	3306.8	324.3	0.1935	97.71 215.41
HM262749TD	HM262710	3.3 0.13	3.3 0.13	456.0 17.95	3646.2	341.8	0.1999	115.19 253.98
M262448TD	M262410	3.3 0.13	3.3 0.13	443.0 17.44	2968.5	408.3	0.1853	100.23 220.99
LM263145TD	LM263110	1.5 0.06	3.3 0.13	434.0 17.09	3094.1	470.9	0.1845	55.07 121.39
HM265049TD	HM265010	3.3 0.13	6.4 0.25	487.0 19.17	4297.3	412.9	0.2106	141.40 311.73
HM266449TD	HM266410	3.3 0.13	6.4 0.25	507.0 19.96	4760.1	301.5	0.2178	157.92 348.16
M268743TD	M268710	3.3 0.13	6.4 0.25	548.9 21.61	5754.9	420.9	0.2319	214.22 472.24
M268749TD	M268710	3.3 0.13	6.4 0.25	548.9 21.61	5754.9	420.9	0.2319	198.81 438.27
LM769349TD	LM769310	1.5 0.06	6.4 0.25	534.0 21.02	5114.6	614.2	0.2426	119.48 263.42
M270749TD	M270710	3.3 0.13	6.4 0.25	591.0 23.27	6865.6	481.9	0.2458	245.12 540.38

<sup>(4)</sup>These maximum fillet radii will be cleared by bearing corners.  
NOTE: For spacer configuration information, contact your Timken engineer.

# TAPERED ROLLER BEARINGS

## DOUBLE-ROW • TYPE TDIT

### TYPE TDIT



Bearing Dimensions					Load Ratings							
Bore d	Taper	O.D. D	Width T	Double Inner Ring Width B	Dynamic <sup>(1)</sup>				Dynamic <sup>(3)</sup>			
					C <sub>1(2)</sub>	e	Y <sub>1</sub>	Y <sub>2</sub>	C <sub>90</sub>	C <sub>a90</sub>	C <sub>90(2)</sub>	K
mm in.		mm in.	mm in.	mm in.	N lbf				N lbf	N lbf	N lbf	
457.200 18.0000	1:12	730.148 28.7460	330.200 13.0000	330.200 13.0000	7050000 1580000	0.29	2.29	3.42	1050000 236000	529000 119000	1830000 411000	1.98
479.425 18.8750	1:12	679.450 26.7500	238.125 9.3750	238.125 9.3750	6500000 1460000	0.33	2.03	3.02	968000 218000	551000 124000	1680000 379000	1.76
501.650 19.7500	1:12	711.200 28.0000	250.825 9.8750	250.825 9.8750	6150000 1380000	0.33	2.03	3.02	916000 206000	521000 117000	1590000 358000	1.76
501.650 19.7500	1:12	711.200 28.0000	250.825 9.8750	250.825 9.8750	6150000 1380000	0.33	2.03	3.02	916000 206000	521000 117000	1590000 358000	1.76
519.112 20.4375	1:12	736.600 29.0000	258.762 10.1875	258.762 10.1875	6570000 1480000	0.33	2.03	3.02	978000 220000	557000 125000	1700000 383000	1.76
571.500 22.5000	1:12	812.800 32.0000	285.750 11.2500	296.862 11.6875	7890000 1770000	0.33	2.03	3.02	1180000 264000	669000 150000	2050000 460000	1.76

<sup>(1)</sup>Based on  $1 \times 10^6$  revolutions  $L_{10}$  life, for the ISO life-calculation method.  $C_{1(2)}$  is the double-row radial value.

<sup>(2)</sup>Consult your Timken engineer for instructions on use or review the Timken Engineering Manual on [timken.com/catalogs](http://timken.com/catalogs).

<sup>(3)</sup>Based on  $90 \times 10^6$  revolutions  $L_{10}$  life, for The Timken Company life-calculation method.  $C_{90}$  and  $C_{a90}$  are radial and thrust values for a single row.  $C_{90(2)}$  is the double-row radial value.

Part Number		Dimensions			Geometry Factors			Bearing Weight
Inner	Outer	Shaft	Housing		G <sub>1</sub>	G <sub>2</sub>	C <sub>g</sub>	
		Max Shaft Fillet Radius R <sup>(4)</sup>	Max Housing Fillet Radius r <sup>(4)</sup>	Backing Shoulder Dia. D <sub>b</sub>				kg lbs.
EE726182TD	726287	<b>6.4</b> 0.25	<b>6.4</b> 0.25	<b>674.9</b> 26.57	7359.2	384.7	0.2413	<b>517.73</b> 1141.38
M272749TD	M272710	<b>3.3</b> 0.13	<b>6.4</b> 0.25	<b>633.0</b> 24.92	8110.8	508.6	0.2598	<b>303.33</b> 668.74
M274149TD	M274110	<b>3.3</b> 0.13	<b>6.4</b> 0.25	<b>663.0</b> 26.10	9019.6	560.7	0.2690	<b>346.76</b> 764.45
M274147TD	M274110	<b>9.7</b> 0.38	<b>6.4</b> 0.25	<b>663.0</b> 26.10	9019.6	560.7	0.2690	<b>355.25</b> 783.17
M275349TD	M275310	<b>3.3</b> 0.13	<b>6.4</b> 0.25	<b>684.0</b> 26.93	9814.6	651.6	0.2766	<b>391.96</b> 864.14
M278748TD	M278710	<b>3.3</b> 0.13	<b>6.4</b> 0.25	<b>756.0</b> 29.76	12425.1	669.4	0.2990	<b>520.85</b> 1148.29

<sup>(4)</sup>These maximum fillet radii will be cleared by bearing corners.  
NOTE: For spacer configuration information, contact your Timken engineer.

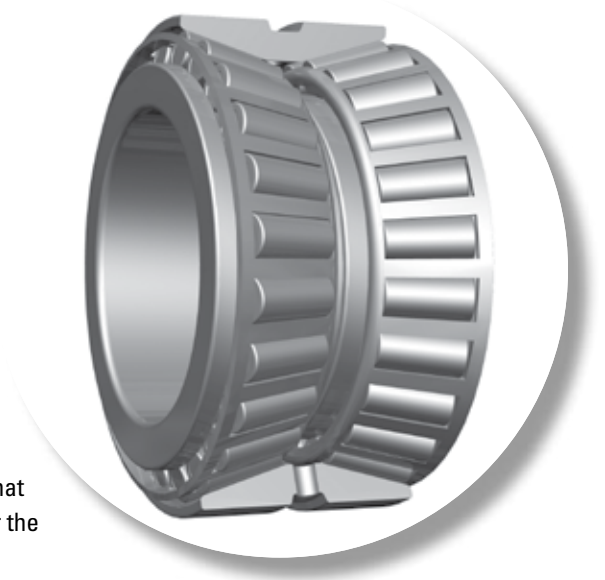
# TAPERED ROLLER BEARINGS

DOUBLE-ROW • TYPE TNA



### TYPE TNA

- TNA bearings are non-adjustable, double-row bearings that are supplied with built-in clearance. This results in a specified mounting setting range satisfactory for specific applications.
- They are similar to type TDO, but the inner-ring front faces are extended so that they abut, which eliminates the need for the inner-ring spacer of a TDO bearing.
- They can be used at either fixed positions or allowed to float in the housing bore to compensate for shaft expansion.



#### DOUBLE-OUTER RING CONFIGURATIONS

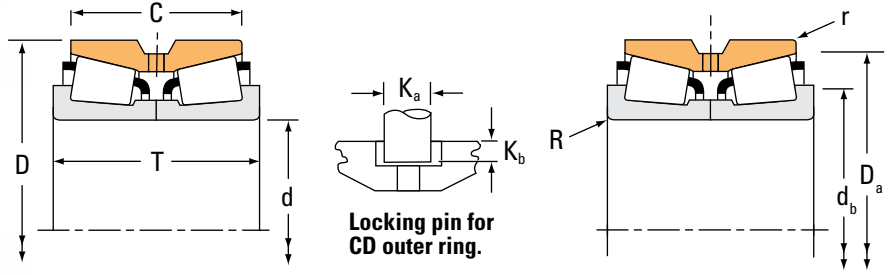
<b>D</b>	D suffix has a groove with oil holes for lubrication through the outer ring.
<b>CD</b>	<p>CD suffix now replaces the DC suffix listed for part numbers in previous publications.</p> <p>Same features as D suffix, but CD also has groove with oil holes. One lubrication hole is counterbored to accept an anti-rotational pin.</p> <p>Default configuration for most series.</p>

- For desired fitting practice and resultant mounted setting range information, contact your Timken engineer.
- If a closer control of mounted setting range is required, type TDO bearing assembly is recommended.
- Consult your Timken engineer before making a final bearing selection to help ensure suitability, availability and the most cost-effective solution.

# TAPERED ROLLER BEARINGS

## DOUBLE-ROW • TYPE TNA

### TYPE TNA



Bearing Dimensions				Load Ratings							
Bore d	O.D. D	Width T	Double Outer Ring Width C	Dynamic <sup>(1)</sup>				Dynamic <sup>(3)</sup>			
				C <sub>1(2)</sub>	e	Factors <sup>(2)</sup> Y <sub>1</sub>	Y <sub>2</sub>	C <sub>90</sub>	C <sub>a90</sub>	C <sub>90(2)</sub>	Factors <sup>(2)</sup> K
mm in.	mm in.	mm in.	mm in.	N lbf				N lbf	N lbf	N lbf	
19.050 0.7500	47.000 1.8504	31.750 1.2500	25.212 0.9926	46500 10500	0.36	1.89	2.82	6930 1560	4230 952	12100 2710	1.64
24.981 0.9835	62.000 2.4409	39.688 1.5625	36.258 1.4275	75300 16900	0.38	1.77	2.63	11200 2520	7340 1650	19500 4390	1.53
28.575 1.1250	74.612 2.9375	55.565 2.1876	41.275 1.6250	121000 27300	0.60	1.12	1.67	18100 4060	18600 4190	31500 7080	0.97
29.987 1.1806	71.973 2.8336	42.760 1.6835	36.512 1.4375	102000 23000	0.36	1.87	2.79	18100 4060	11100 2500	31400 7070	1.62
31.750 1.2500	58.738 2.3125	32.542 1.2812	24.608 0.9688	55200 12400	0.47	1.42	2.12	8220 1850	6670 1500	14300 3220	1.23
33.337 1.3125	80.962 3.1875	55.562 2.1875	39.688 1.5625	135000 30400	0.67	1.01	1.50	20100 4520	23000 5170	35000 7880	0.87
34.925 1.3750	69.012 2.7170	46.040 1.8126	38.100 1.5000	95100 21400	0.38	1.77	2.63	14200 3180	9260 2080	24600 5540	1.53
34.976 1.3770	80.035 3.1510	46.040 1.8126	34.925 1.3750	111000 24800	0.40	1.68	2.50	19500 4390	13400 3020	34000 7640	1.45
36.512 1.4375	92.075 3.6250	55.562 2.1875	39.688 1.5625	147000 32900	0.78	0.86	1.29	25900 5810	34600 7770	45000 10100	0.75
38.100 1.5000	69.012 2.7170	46.035 1.8124	38.100 1.5000	98700 22200	0.40	1.68	2.50	17400 3920	12000 2700	30300 6820	1.45
39.687 1.5625	88.500 3.4843	55.562 2.1875	39.688 1.5625	147000 32900	0.78	0.86	1.29	21800 4910	29200 6560	38000 8540	0.75
39.687 1.5625	92.075 3.6250	55.562 2.1875	39.688 1.5625	147000 32900	0.78	0.86	1.29	21800 4910	29200 6560	38000 8540	0.75
40.000 1.5748	90.119 3.5480	50.800 2.0000	44.450 1.7500	142000 32000	0.31	2.20	3.28	21200 4770	11100 2500	36900 8310	1.91
41.275 1.6250	92.075 3.6250	55.562 2.1875	39.688 1.5625	174000 39100	0.78	0.86	1.29	25900 5810	34600 7770	45000 10100	0.75
43.658 1.7188	82.550 3.2500	44.450 1.7500	34.925 1.3750	135000 30300	0.43	1.57	2.34	20100 4510	14800 3320	35000 7860	1.36
44.450 1.7500	79.375 3.1250	41.272 1.6249	33.338 1.3125	90600 20400	0.37	1.80	2.69	13500 3030	8630 1940	23500 5280	1.56
44.450 1.7500	95.250 3.7500	61.915 2.4376	50.800 2.0000	221000 49700	0.28	2.37	3.53	32900 7400	16000 3600	57300 12900	2.05

<sup>(1)</sup>Based on  $1 \times 10^6$  revolutions  $L_{10}$  life, for the ISO life-calculation method.  $C_{1(2)}$  is the double-row radial value.

<sup>(2)</sup>Consult your Timken engineer for instructions on use or review the Timken Engineering Manual on [timken.com/catalogs](http://timken.com/catalogs).

<sup>(3)</sup>Based on  $90 \times 10^6$  revolutions  $L_{10}$  life, for The Timken Company life-calculation method.  $C_{90}$  and  $C_{a90}$  are radial and thrust values for a single row.  $C_{90(2)}$  is the double-row radial value.

Part Number		Dimensions						Bearing Weight
Inner	Outer	Shaft		Housing		Pin		
		Max Shaft Fillet Radius	Backing Shoulder Dia.	Max Housing Fillet Radius	Backing Shoulder Dia.	K <sub>a</sub>	K <sub>b</sub>	
		R <sup>(4)</sup>	d <sub>b</sub>	r <sup>(4)</sup>	D <sub>a</sub>			
mm	mm	mm	mm	mm	mm	mm	mm	kg
in.	in.	in.	in.	in.	in.	in.	in.	lbs.
NA05075	05185D	1.3 0.05	25.0 0.98	0.8 0.03	42.5 1.67	— —	— —	0.23 0.51
NA17098	17245D	1.5 0.06	33.0 1.30	0.8 0.03	57.0 2.24	— —	— —	0.62 1.36
NA41125	41294D	2.3 0.09	43.0 1.69	1.5 0.06	68.0 2.68	— —	— —	1.12 2.45
NA26118	26284D	1.5 0.06	38.0 1.50	0.8 0.03	65.0 2.56	— —	— —	0.84 1.87
NA08125	08231D	1.5 0.06	38.5 1.52	0.4 0.02	55.0 2.17	— —	— —	0.35 0.79
NA43131	43319D	2.3 0.09	48.5 1.91	1.5 0.06	74.0 2.91	— —	— —	1.28 2.82
NA14138	14276D	3.5 0.14	46.0 1.81	0.8 0.03	63.0 2.48	— —	— —	0.70 1.56
NA28138	28318D	1.5 0.06	43.5 1.71	0.8 0.03	73.0 2.87	— —	— —	1.04 2.32
NA44143	44363D	0.8 0.03	51.0 2.01	1.5 0.06	85.0 3.35	— —	— —	1.73 3.85
NA13687	13621D	2.0 0.08	46.5 1.83	0.8 0.03	65.0 2.56	— —	— —	0.67 1.48
NA44156	44348D	2.3 0.09	56.0 2.20	0.6 0.03	84.0 3.31	— —	— —	1.48 3.26
NA44156	44363D	2.3 0.09	56.0 2.20	1.5 0.06	85.0 3.35	— —	— —	1.65 3.65
NA357	353D	1.5 0.06	49.0 1.93	0.8 0.03	82.0 3.23	— —	— —	1.54 3.39
NA44163	44363D	0.8 0.03	54.0 2.13	1.5 0.06	85.0 3.35	— —	— —	1.61 3.57
NA22171	22325D	2.3 0.09	53.0 2.09	0.8 0.03	76.0 2.99	— —	— —	1.01 2.21
NA18685	18620D	2.8 0.11	54.0 2.13	0.8 0.03	74.0 2.91	— —	— —	0.80 1.75
NA438	432D	3.5 0.14	57.0 2.24	0.8 0.03	87.0 3.43	— —	— —	2.00 4.41

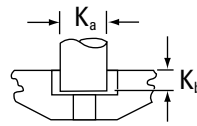
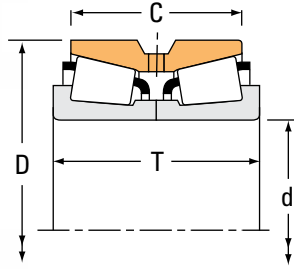
<sup>(4)</sup>These maximum fillet radii will be cleared by bearing corners.

NOTE: For desired fitting practice and resultant mounted setting range information, contact your Timken engineer.

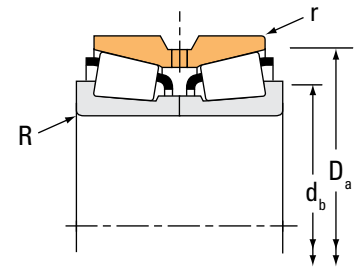
# TAPERED ROLLER BEARINGS

## DOUBLE-ROW • TYPE TNA

### TYPE TNA



Locking pin for CD outer ring.



Bearing Dimensions				Load Ratings							
Bore d	O.D. D	Width T	Double Outer Ring Width C	Dynamic <sup>(1)</sup>				Dynamic <sup>(3)</sup>			
				C <sub>1(2)</sub>	e	Y <sub>1</sub>	Y <sub>2</sub>	C <sub>90</sub>	C <sub>a90</sub>	C <sub>90(2)</sub>	K
mm in.	mm in.	mm in.	mm in.	N lbf				N lbf	N lbf	N lbf	
44.450 1.7500	95.250 3.7500	65.090 2.5626	44.450 1.7500	174000 39200	0.74	0.91	1.36	26000 5840	32900 7390	45200 10200	0.79
44.450 1.7500	98.425 3.8750	65.090 2.5626	44.450 1.7500	174000 39200	0.74	0.91	1.36	26000 5840	32900 7390	45200 10200	0.79
50.000 1.9685	90.000 3.5433	50.010 1.9689	42.070 1.6563	177000 39900	0.32	2.11	3.14	26400 5930	14400 3250	46000 10300	1.83
50.800 2.0000	93.264 3.6718	65.088 2.5625	52.388 2.0625	213000 47800	0.34	1.99	2.97	31700 7120	18300 4120	55100 12400	1.73
50.800 2.0000	107.950 4.2500	65.090 2.5626	53.975 2.1250	236000 53100	0.34	2.01	3.00	35200 7900	20200 4540	61200 13800	1.74
50.800 2.0000	112.712 4.4375	65.088 2.5625	46.038 1.8125	185000 41600	0.88	0.76	1.14	27600 6200	41700 9380	48000 10800	0.66
53.975 2.1250	111.125 4.3750	79.375 3.1250	63.500 2.5000	300000 67400	0.30	2.28	3.39	44600 10000	22700 5090	77700 17500	1.97
53.975 2.1250	117.475 4.6250	73.025 2.8750	53.975 2.1250	259000 58300	0.63	1.08	1.60	38600 8680	41400 9310	67200 15100	0.93
53.975 2.1250	123.825 4.8750	77.788 3.0625	55.562 2.1875	287000 64600	0.74	0.92	1.36	42800 9620	54000 12100	74500 16800	0.79
55.000 2.1654	100.000 3.9370	52.388 2.0625	42.862 1.6875	188000 42200	0.35	1.91	2.84	28000 6280	16900 3810	48700 10900	1.65
60.000 2.3622	110.000 4.3307	52.388 2.0625	46.038 1.8125	172000 38700	0.40	1.68	2.50	25600 5760	17600 3970	44600 10000	1.45
60.000 2.3622	120.000 4.7244	65.090 2.5626	53.975 2.1250	250000 56100	0.38	1.75	2.61	37200 8360	24500 5500	64700 14600	1.52
60.325 2.3750	123.825 4.8750	79.375 3.1250	63.500 2.5000	332000 74700	0.35	1.95	2.90	49400 11100	29300 6590	86100 19400	1.69
63.500 2.5000	139.700 5.5000	77.788 3.0625	51.803 2.0395	353000 79300	0.87	0.78	1.16	52600 11800	77900 17500	91500 20600	0.67
66.675 2.6250	127.000 5.0000	80.962 3.1875	65.088 2.5625	342000 76900	0.36	1.86	2.76	50900 11400	31700 7130	88600 19900	1.61
69.850 2.7500	120.000 4.7244	65.090 2.5626	53.975 2.1250	250000 56100	0.38	1.75	2.61	37200 8360	24500 5500	64700 14600	1.52
69.850 2.7500	136.525 5.3750	95.250 3.7500	76.200 3.0000	406000 91200	0.36	1.86	2.78	60400 13600	37400 8420	105000 23600	1.61

<sup>(1)</sup>Based on  $1 \times 10^6$  revolutions  $L_{10}$  life, for the ISO life-calculation method.  $C_{1(2)}$  is the double-row radial value.

<sup>(2)</sup>Consult your Timken engineer for instructions on use or review the Timken Engineering Manual on [timken.com/catalogs](http://timken.com/catalogs).

<sup>(3)</sup>Based on  $90 \times 10^6$  revolutions  $L_{10}$  life, for The Timken Company life-calculation method.  $C_{90}$  and  $C_{a90}$  are radial and thrust values for a single row.  $C_{90(2)}$  is the double-row radial value.

Part Number		Dimensions						Bearing Weight
Inner	Outer	Shaft		Housing		Pin		
		Max Shaft Fillet Radius	Backing Shoulder Dia.	Max Housing Fillet Radius	Backing Shoulder Dia.	K <sub>a</sub>	K <sub>b</sub>	
		R <sup>(4)</sup>	d <sub>b</sub>	r <sup>(4)</sup>	D <sub>a</sub>			
mm in.	mm in.	mm in.	mm in.	mm in.	mm in.	mm in.	kg lbs.	
NA53176	53376D	2.3 0.09	61.0 2.40	0.8 0.03	89.0 3.50	— —	— —	1.92 4.21
NA53176	53390D	2.3 0.09	61.0 2.40	1.5 0.06	90.0 3.54	— —	— —	2.10 4.62
NA366	363D	3.5 0.14	61.0 2.40	0.8 0.03	84.0 3.31	— —	— —	1.18 2.61
NA3780	3729D	3.5 0.14	64.0 2.52	0.8 0.03	87.9 3.46	— —	— —	1.83 4.02
NA455	452D	3.5 0.14	65.0 2.56	0.8 0.03	100.0 3.94	— —	— —	2.76 6.10
NA55200	55444D	2.3 0.09	69.0 2.72	1.5 0.06	105.0 4.13	— —	— —	2.85 6.25
NA539	533D	3.5 0.14	68.0 2.68	1.5 0.06	100.0 3.94	— —	— —	3.35 7.39
NA66212	66462D	3.5 0.14	73.0 2.87	0.8 0.03	111.0 4.37	— —	— —	3.56 7.82
NA72212	72488D	2.3 0.09	74.0 2.91	1.5 0.06	115.0 4.53	— —	— —	4.08 9.00
NA385	384CD	3.5 0.14	67.0 2.64	0.8 0.03	93.0 3.66	7.94 0.31	4.77 0.19	1.56 3.45
NA397	394D	3.5 0.14	74.0 2.91	0.8 0.03	104.4 4.11	— —	— —	2.04 4.51
NA476	472D	3.5 0.14	76.0 2.99	0.8 0.03	114.0 4.49	— —	— —	3.45 7.59
NA558	552D	3.5 0.14	76.0 2.99	1.5 0.06	115.0 4.53	— —	— —	4.31 9.50
NA78250	78549D	2.3 0.09	85.0 3.35	1.5 0.06	131.0 5.16	— —	— —	5.11 11.28
NA569	563D	3.5 0.14	82.0 3.23	1.5 0.06	119.0 4.69	— —	— —	4.36 9.64
NA482	472D	3.5 0.14	83.0 3.27	0.8 0.03	114.0 4.49	— —	— —	2.93 6.46
NA643	632D	3.5 0.14	86.0 3.39	1.5 0.06	125.0 4.92	— —	— —	5.88 12.92

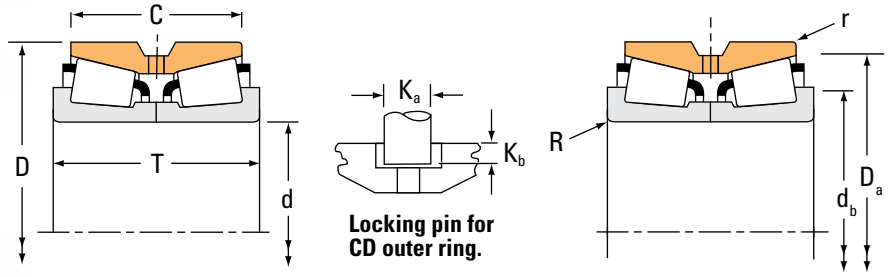
<sup>(4)</sup>These maximum fillet radii will be cleared by bearing corners.

NOTE: For desired fitting practice and resultant mounted setting range information, contact your Timken engineer.

# TAPERED ROLLER BEARINGS

## DOUBLE-ROW • TYPE TNA

### TYPE TNA



Bearing Dimensions				Load Ratings							
Bore d	O.D. D	Width T	Double Outer Ring Width C	Dynamic <sup>(1)</sup>				Dynamic <sup>(3)</sup>			
				C <sub>1(2)</sub>	e	Factors <sup>(2)</sup> Y <sub>1</sub>	Y <sub>2</sub>	C <sub>90</sub>	C <sub>a90</sub>	C <sub>90(2)</sub>	Factors <sup>(2)</sup> K
mm in.	mm in.	mm in.	mm in.	N lbf				N lbf	N lbf	N lbf	
70.000 2.7559	120.000 4.7244	65.090 2.5626	53.975 2.1250	250000 56100	0.38	1.75	2.61	37200 8360	24500 5500	64700 14600	1.52
73.025 2.8750	127.000 5.0000	80.962 3.1875	65.088 2.5625	342000 76900	0.36	1.86	2.76	50900 11400	31700 7130	88600 19900	1.61
76.200 3.0000	136.525 5.3750	69.850 2.7500	53.975 2.1250	269000 60500	0.44	1.52	2.26	40000 9000	30500 6850	69700 15700	1.31
76.200 3.0000	152.400 6.0000	95.250 3.7500	76.200 3.0000	430000 96700	0.41	1.65	2.46	64000 14400	44800 10100	112000 25100	1.43
76.200 3.0000	177.800 7.0000	109.538 4.3125	74.612 2.9375	632000 142000	0.76	0.88	1.31	94100 21200	123000 27700	164000 36800	0.76
82.550 3.2500	139.992 5.5115	82.550 3.2500	66.675 2.6250	360000 80900	0.40	1.67	2.49	53600 12100	37100 8330	93400 21000	1.45
82.550 3.2500	155.575 6.1250	101.600 4.0000	85.725 3.3750	656000 147000	0.33	2.08	3.09	97600 21900	54400 12200	170000 38200	1.80
82.550 3.2500	171.450 6.7500	125.412 4.9375	100.012 3.9375	712000 160000	0.30	2.26	3.36	106000 23800	54300 12200	185000 41500	1.95
88.900 3.5000	152.400 6.0000	82.550 3.2500	63.500 2.5000	376000 84600	0.44	1.53	2.27	56000 12600	42400 9530	97500 21900	1.32
88.900 3.5000	161.925 6.3750	104.775 4.1250	85.725 3.3750	570000 128000	0.34	1.98	2.95	84800 19100	49500 11100	148000 33200	1.71
88.900 3.5000	200.025 7.8750	115.888 4.5625	80.216 3.1581	708000 159000	0.63	1.07	1.59	105000 23700	114000 25600	183000 41200	0.92
95.250 3.7500	161.925 6.3750	82.547 3.2499	61.912 2.4375	389000 87500	0.47	1.42	2.12	57900 13000	47100 10600	101000 22700	1.23
95.250 3.7500	180.975 7.1250	104.775 4.1250	85.725 3.3750	603000 135000	0.39	1.75	2.61	89700 20200	59200 13300	156000 35100	1.51
100.000 3.9370	168.275 6.6250	92.075 3.6250	69.850 2.7500	461000 104000	0.47	1.43	2.14	68600 15400	55300 12400	119000 26900	1.24
101.600 4.0000	168.275 6.6250	92.075 3.6250	69.850 2.7500	461000 104000	0.47	1.43	2.14	68600 15400	55300 12400	119000 26900	1.24
101.600 4.0000	180.000 7.0866	104.775 4.1250	85.725 3.3750	603000 135000	0.39	1.75	2.61	89700 20200	59200 13300	156000 35100	1.51
101.600 4.0000	180.975 7.1250	104.775 4.1250	85.725 3.3750	603000 135000	0.39	1.75	2.61	89700 20200	59200 13300	156000 35100	1.51

<sup>(1)</sup>Based on  $1 \times 10^6$  revolutions  $L_{10}$  life, for the ISO life-calculation method.  $C_{1(2)}$  is the double-row radial value.

<sup>(2)</sup>Consult your Timken engineer for instructions on use or review the Timken Engineering Manual on [timken.com/catalogs](http://timken.com/catalogs).

<sup>(3)</sup>Based on  $90 \times 10^6$  revolutions  $L_{10}$  life, for The Timken Company life-calculation method.  $C_{90}$  and  $C_{a90}$  are radial and thrust values for a single row.  $C_{90(2)}$  is the double-row radial value.

Part Number		Dimensions						Bearing Weight
Inner	Outer	Shaft		Housing		Pin		
		Max Shaft Fillet Radius	Backing Shoulder Dia.	Max Housing Fillet Radius	Backing Shoulder Dia.	K <sub>a</sub>	K <sub>b</sub>	
		R <sup>(4)</sup>	d <sub>b</sub>	r <sup>(4)</sup>	D <sub>a</sub>			
mm in.	mm in.	mm in.	mm in.	mm in.	mm in.	mm in.	kg lbs.	
NA484	472D	3.5 0.14	83.0 3.27	0.8 0.03	114.0 4.49	– –	– –	2.93 6.44
NA567	563D	6.8 0.27	94.0 3.70	1.5 0.06	119.0 4.69	– –	– –	3.86 8.52
NA495A	493D	3.5 0.14	92.0 3.62	0.8 0.03	130.0 5.12	– –	– –	4.14 9.12
NA659	654D	3.5 0.14	93.0 3.66	1.5 0.06	141.0 5.55	– –	– –	7.61 16.77
NA9378	9320D	3.5 0.14	105.0 4.13	2.3 0.09	164.0 6.46	– –	– –	12.34 27.20
NA580	572D	3.5 0.14	98.0 3.86	0.8 0.03	133.0 5.24	– –	– –	4.79 10.56
NA749	742D	3.5 0.14	99.0 3.90	1.5 0.06	143.0 5.63	– –	– –	8.17 18.01
NA842	834D	3.5 0.14	101.0 3.98	0.8 0.03	155.0 6.10	– –	– –	13.10 28.88
NA593	592D	3.5 0.14	104.0 4.09	0.8 0.03	144.0 5.67	– –	– –	5.87 12.93
NA759	752D	3.5 0.14	106.0 4.17	1.5 0.06	150.0 5.91	– –	– –	8.76 19.28
NA98350	98789D	3.5 0.14	118.0 4.65	2.3 0.09	188.0 7.40	– –	– –	16.57 36.50
NA52375	52637D	3.5 0.14	112.0 4.41	0.8 0.03	154.0 6.06	– –	– –	6.53 14.41
NA776	774CD	3.5 0.14	114.0 4.49	1.5 0.06	168.0 6.61	19.05 0.75	7.13 0.28	11.44 25.21
NA691A	672D	3.5 0.14	119.0 4.69	0.8 0.03	160.0 6.30	– –	– –	7.62 16.78
NA691	672D	3.5 0.14	118.0 4.65	0.8 0.03	160.0 6.30	– –	– –	7.58 16.69
NA780	773D	3.5 0.14	119.0 4.69	0.8 0.03	168.0 6.61	– –	– –	10.67 23.56
NA780	774CD	3.5 0.14	119.0 4.69	1.5 0.06	168.0 6.61	19.05 0.75	7.13 0.28	10.62 23.43

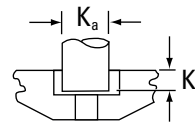
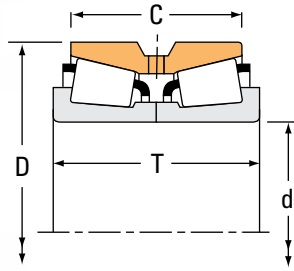
<sup>(4)</sup>These maximum fillet radii will be cleared by bearing corners.

NOTE: For desired fitting practice and resultant mounted setting range information, contact your Timken engineer.

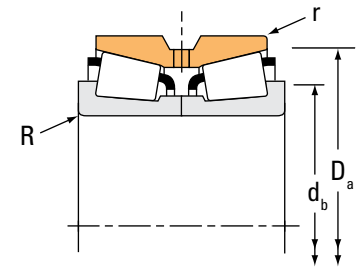
# TAPERED ROLLER BEARINGS

## DOUBLE-ROW • TYPE TNA

### TYPE TNA



Locking pin for CD outer ring.



Bearing Dimensions				Load Ratings							
Bore d	O.D. D	Width T	Double Outer Ring Width C	Dynamic <sup>(1)</sup>				Dynamic <sup>(3)</sup>			
				C <sub>1(2)</sub>	e	Factors <sup>(2)</sup> Y <sub>1</sub>	Y <sub>2</sub>	C <sub>90</sub>	C <sub>a90</sub>	C <sub>90(2)</sub>	Factors <sup>(2)</sup> K
mm in.	mm in.	mm in.	mm in.	N lbf				N lbf	N lbf	N lbf	
101.600 4.0000	190.500 7.5000	127.000 5.0000	101.600 4.0000	797000 179000	0.33	2.02	3.00	119000 26700	68000 15300	207000 46400	1.74
101.600 4.0000	190.500 7.5000	127.000 5.0000	104.775 4.1250	929000 209000	0.33	2.02	3.00	138000 31100	79300 17800	241000 54200	1.74
104.775 4.1250	180.975 7.1250	104.775 4.1250	85.725 3.3750	603000 135000	0.39	1.75	2.61	89700 20200	59200 13300	156000 35100	1.51
114.300 4.5000	190.500 7.5000	106.362 4.1875	80.962 3.1875	633000 142000	0.42	1.62	2.42	94300 21200	67100 15100	164000 36900	1.40
114.300 4.5000	228.600 9.0000	115.888 4.5625	84.138 3.3125	655000 147000	0.74	0.92	1.36	97500 21900	123000 27600	170000 38200	0.79
114.300 4.5000	228.600 9.0000	115.888 4.5625	84.138 3.3125	862000 194000	0.74	0.92	1.36	128000 28800	162000 36400	223000 50200	0.79
127.000 5.0000	182.562 7.1875	85.725 3.3750	73.025 2.8750	466000 105000	0.31	2.21	3.29	69400 15600	36300 8160	121000 27200	1.91
133.350 5.2500	190.500 7.5000	85.725 3.3750	73.025 2.8750	492000 111000	0.32	2.10	3.13	73300 16500	40300 9060	128000 28700	1.82
142.875 5.6250	200.025 7.8750	93.665 3.6876	73.025 2.8750	499000 112000	0.34	2.01	2.99	74300 16700	42800 9610	129000 29100	1.74
146.050 5.7500	236.538 9.3125	131.762 5.1875	106.362 4.1875	897000 202000	0.44	1.53	2.27	134000 30000	101000 22700	232000 52300	1.32
146.050 5.7500	241.300 9.5000	131.762 5.1875	106.362 4.1875	1040000 234000	0.32	2.12	3.15	155000 34800	84500 19000	269000 60600	1.83
149.225 5.8750	236.538 9.3125	131.762 5.1875	106.362 4.1875	897000 202000	0.44	1.53	2.27	134000 30000	101000 22700	232000 52300	1.32
149.225 5.8750	241.300 9.5000	131.762 5.1875	106.362 4.1875	1040000 234000	0.32	2.12	3.15	155000 34800	84500 19000	269000 60600	1.83
150.967 5.9436	229.873 9.0501	108.000 4.2520	116.000 4.5669	597000 134000	0.33	2.03	3.02	88900 20000	50600 11400	155000 34800	1.76
152.400 6.0000	254.000 10.0000	142.875 5.6250	111.125 4.3750	1150000 258000	0.41	1.66	2.47	171000 38500	119000 26800	298000 67000	1.43
165.100 6.5000	298.450 11.7500	142.875 5.6250	111.125 4.3750	1150000 258000	0.47	1.44	2.15	171000 38500	137000 30800	298000 67000	1.25
177.800 7.0000	282.575 11.1250	107.950 4.2500	79.375 3.1250	748000 168000	0.42	1.62	2.42	132000 29700	93900 21100	230000 51700	1.41

<sup>(1)</sup>Based on  $1 \times 10^6$  revolutions  $L_{10}$  life, for the ISO life-calculation method.  $C_{1(2)}$  is the double-row radial value.

<sup>(2)</sup>Consult your Timken engineer for instructions on use or review the Timken Engineering Manual on [timken.com/catalogs](http://timken.com/catalogs).

<sup>(3)</sup>Based on  $90 \times 10^6$  revolutions  $L_{10}$  life, for The Timken Company life-calculation method.  $C_{90}$  and  $C_{a90}$  are radial and thrust values for a single row.  $C_{90(2)}$  is the double-row radial value.



Part Number		Dimensions						Bearing Weight
Inner	Outer	Shaft		Housing		Pin		
		Max Shaft Fillet Radius	Backing Shoulder Dia.	Max Housing Fillet Radius	Backing Shoulder Dia.	K <sub>a</sub>	K <sub>b</sub>	
		R <sup>(4)</sup>	d <sub>b</sub>	r <sup>(4)</sup>	D <sub>a</sub>			
		mm in.	mm in.	mm in.	mm in.	mm in.	mm in.	kg lbs.
NA861	854D	3.5 0.14	120.0 4.72	1.5 0.06	174.0 6.85	– –	– –	14.98 33.03
HH221449NA	HH221410D	3.5 0.14	122.0 4.80	1.5 0.06	179.0 7.05	– –	– –	14.81 32.64
NA782	774CD	3.5 0.14	122.0 4.80	1.5 0.06	168.0 6.61	19.05 0.75	7.13 0.28	10.20 22.50
NA71450	71751D	3.5 0.14	132.0 5.20	1.5 0.06	181.0 7.13	– –	– –	11.08 24.43
NA97450	97901D	3.5 0.14	140.0 5.51	2.3 0.09	213.0 8.38	– –	– –	19.81 43.70
HM926740NA	HM926710CD	3.5 0.14	146.0 5.75	2.3 0.09	219.3 8.63	19.05 0.75	8.73 0.34	20.61 45.41
NA48291	48220D	3.5 0.14	141.0 5.55	0.8 0.03	176.0 6.93	– –	– –	7.13 15.71
NA48385	48320D	3.5 0.14	148.0 5.83	0.8 0.03	184.0 7.24	– –	– –	7.45 16.45
NA48686	48620D	3.5 0.14	158.0 6.22	0.8 0.03	193.0 7.60	– –	– –	8.41 18.56
NA82576	82932D	3.5 0.14	166.0 6.54	1.5 0.06	226.0 8.90	– –	– –	20.60 45.41
HM231140NA	HM231116D	3.5 0.14	164.0 6.46	1.5 0.06	224.0 8.82	– –	– –	22.00 48.50
NA82587	82932D	3.5 0.14	169.0 6.65	1.5 0.06	226.0 8.90	– –	– –	19.82 43.73
HM231149NA	HM231116D	3.5 0.14	167.0 6.57	1.5 0.06	224.0 8.82	– –	– –	21.24 46.82
M231647	M231616XD	3.5 0.14	168.0 6.61	** **	222.0 8.74	– –	– –	16.14 35.57
NA99600	99102CD	3.5 0.14	177.0 6.97	1.5 0.06	238.0 9.37	0.87	0.31	26.54 58.51
NA94650	94118D	3.5 0.14	190.0 7.48	1.5 0.06	272.0 10.71	– –	– –	41.69 91.93
NA87700	87112D	3.5 0.14	200.0 7.87	1.5 0.06	267.0 10.50	– –	– –	23.05 50.80

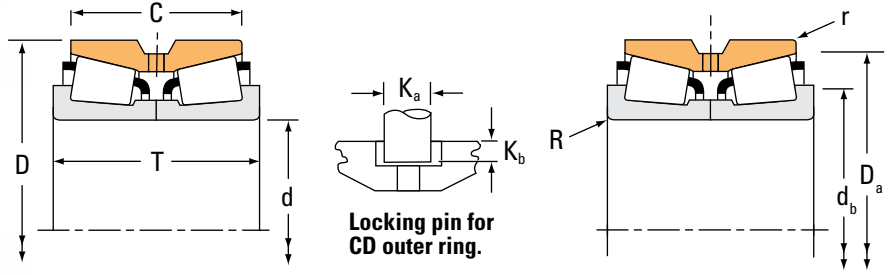
<sup>(4)</sup>These maximum fillet radii will be cleared by bearing corners.

NOTE: For desired fitting practice and resultant mounted setting range information, contact your Timken engineer.

# TAPERED ROLLER BEARINGS

## DOUBLE-ROW • TYPE TNA

### TYPE TNA



Bearing Dimensions				Load Ratings							
Bore d	O.D. D	Width T	Double Outer Ring Width C	Dynamic <sup>(1)</sup>				Dynamic <sup>(3)</sup>			
				C <sub>1(2)</sub>	e	Factors <sup>(2)</sup> Y <sub>1</sub>	Y <sub>2</sub>	C <sub>90</sub>	C <sub>a90</sub>	C <sub>90(2)</sub>	Factors <sup>(2)</sup> K
mm in.	mm in.	mm in.	mm in.	N lbf				N lbf	N lbf	N lbf	
177.800 7.0000	298.450 11.7500	142.875 5.6250	139.700 5.5000	1150000 258000	0.47	1.44	2.15	171000 38500	137000 30800	298000 67000	1.25
177.800 7.0000	298.450 11.7500	142.875 5.6250	111.125 4.3750	1150000 258000	0.47	1.44	2.15	171000 38500	137000 30800	298000 67000	1.25
190.500 7.5000	260.350 10.2500	66.675 2.6250	50.800 2.0000	410000 92100	0.34	1.97	2.93	61000 13700	35800 8040	106000 23900	1.70
203.200 8.0000	317.500 12.5000	120.650 4.7500	88.900 3.5000	919000 207000	0.31	2.15	3.21	137000 30800	73400 16500	238000 53600	1.86
254.000 10.0000	422.275 16.6250	173.038 6.8125	128.588 5.0625	2610000 587000	0.33	2.03	3.02	389000 87400	221000 49700	677000 152000	1.76
254.000 10.0000	431.724 16.9970	173.038 6.8125	128.588 5.0625	2690000 605000	0.33	2.03	3.02	401000 90100	228000 51300	698000 157000	1.76
254.000 10.0000	431.724 16.9970	173.038 6.8125	128.588 5.0625	2610000 587000	0.33	2.03	3.02	389000 87400	221000 49700	677000 152000	1.76
260.350 10.2500	422.275 16.6250	173.038 6.8125	128.588 5.0625	2690000 605000	0.33	2.03	3.02	401000 90100	228000 51300	698000 157000	1.76
260.350 10.2500	422.275 16.6250	173.038 6.8125	128.588 5.0625	2610000 587000	0.33	2.03	3.02	389000 87400	221000 49700	677000 152000	1.76
260.350 10.2500	431.724 16.9970	173.038 6.8125	128.588 5.0625	2690000 605000	0.33	2.03	3.02	401000 90100	228000 51300	698000 157000	1.76
260.350 10.2500	431.724 16.9970	173.038 6.8125	128.588 5.0625	2610000 587000	0.33	2.03	3.02	389000 87400	221000 49700	677000 152000	1.76
300.787 11.8420	438.048 17.2460	161.925 6.3750	123.825 4.8750	1880000 422000	0.33	2.04	3.03	280000 62900	159000 35700	487000 110000	1.76
300.787 11.8420	438.048 17.2460	161.925 6.3750	123.825 4.8750	1920000 432000	0.33	2.04	3.03	286000 64300	162000 36500	498000 112000	1.76
300.787 11.8420	444.500 17.5000	161.925 6.3750	161.925 6.3750	1880000 422000	0.33	2.04	3.03	280000 62900	159000 35700	487000 110000	1.76
304.800 12.0000	438.048 17.2460	161.925 6.3750	123.825 4.8750	1880000 422000	0.33	2.04	3.03	280000 62900	159000 35700	487000 110000	1.76
304.800 12.0000	438.048 17.2460	161.925 6.3750	123.825 4.8750	1920000 432000	0.33	2.04	3.03	286000 64300	162000 36500	498000 112000	1.76
355.600 14.0000	514.350 20.2500	146.050 5.7500	107.950 4.2500	1830000 412000	0.44	1.53	2.28	273000 61300	206000 46200	475000 107000	1.33
406.400 16.0000	574.675 22.6250	157.162 6.1875	106.362 4.1875	1930000 434000	0.50	1.36	2.02	287000 64600	245000 55000	500000 112000	1.17

<sup>(1)</sup>Based on 1 x 10<sup>6</sup> revolutions L<sub>10</sub> life, for the ISO life-calculation method. C<sub>1(2)</sub> is the double-row radial value.

<sup>(2)</sup>Consult your Timken engineer for instructions on use or review the Timken Engineering Manual on [timken.com/catalogs](http://timken.com/catalogs).

<sup>(3)</sup>Based on 90 x 10<sup>6</sup> revolutions L<sub>10</sub> life, for The Timken Company life-calculation method. C<sub>90</sub> and C<sub>a90</sub> are radial and thrust values for a single row. C<sub>90(2)</sub> is the double-row radial value.

Part Number		Dimensions						Bearing Weight
Inner	Outer	Shaft		Housing		Pin		
		Max Shaft Fillet Radius	Backing Shoulder Dia.	Max Housing Fillet Radius	Backing Shoulder Dia.	K <sub>a</sub>	K <sub>b</sub>	
		R <sup>(4)</sup>	d <sub>b</sub>	r <sup>(4)</sup>	D <sub>a</sub>			
mm in.	mm in.	mm in.	mm in.	mm in.	mm in.	kg lbs.		
NA94700	94117D	5.5 0.22	203.0 7.99	1.5 0.06	279.0 10.98	–	–	40.07 88.35
NA94700	94118D	5.5 0.22	203.0 7.99	1.5 0.06	272.0 10.71	–	–	37.85 83.46
NA537075	537103D	3.5 0.14	206.0 8.11	0.8 0.03	246.9 9.72	–	–	9.54 21.00
NA132083	132126D	6.4 0.25	230.1 9.06	1.5 0.06	293.1 11.54	–	–	33.51 73.89
HM252343NA	HM252311D	6.4 0.25	286.0 11.26	1.5 0.06	400.0 15.73	–	–	85.70 188.93
HM252344NA	HM252315CD	6.4 0.25	286.0 11.26	1.5 0.06	398.3 15.68	28.58 1.13	11.91 0.47	96.42 212.55
HM252343NA	HM252315CD	6.4 0.25	286.0 11.26	1.5 0.06	398.3 15.68	28.58 1.13	11.91 0.47	92.05 202.94
HM252349NA	HM252311D	6.4 0.25	291.0 11.46	1.5 0.06	400.0 15.73	–	–	86.59 190.86
HM252348NA	HM252311D	6.4 0.25	291.0 11.46	1.5 0.06	400.0 15.73	–	–	82.22 181.24
HM252349NA	HM252315CD	6.4 0.25	291.0 11.46	1.5 0.06	398.3 15.68	28.58 1.13	11.91 0.47	92.94 204.87
HM252348NA	HM252315CD	6.4 0.25	291.0 11.46	1.5 0.06	398.3 15.68	28.58 1.13	11.91 0.47	88.57 195.25
NA329116	329173CD	6.4 0.25	330.0 12.99	1.5 0.06	414.1 16.30	22.23 0.88	11.12 0.44	73.86 162.84
NA329115	329173CD	6.4 0.25	330.0 12.99	1.5 0.06	414.1 16.30	22.23 0.88	11.12 0.44	75.86 167.26
NA329116	329176D	6.4 0.25	330.0 12.99	1.5 0.06	422.5 16.64	–	–	83.75 184.65
NA329120	329173CD	6.4 0.25	333.0 13.11	1.5 0.06	414.1 16.30	22.23 0.88	11.12 0.44	71.44 157.49
NA329121	329173CD	6.4 0.25	333.0 13.11	1.5 0.06	414.1 16.30	22.23 0.88	11.12 0.44	73.44 161.91
NA231400	232026D	6.4 0.25	388.0 15.28	1.5 0.06	481.1 18.94	–	–	91.10 200.84
NA285160	285228D	6.4 0.25	441.0 17.36	1.5 0.06	534.0 21.02	–	–	112.79 248.66

<sup>(4)</sup>These maximum fillet radii will be cleared by bearing corners.

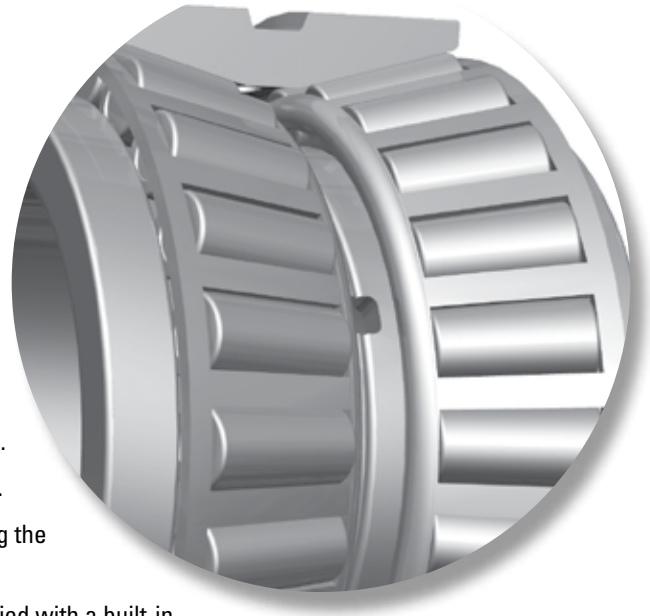
NOTE: For desired fitting practice and resultant mounted setting range information, contact your Timken engineer.

# TAPERED ROLLER BEARINGS

DOUBLE ROW • TYPE TNASW • TYPE TNASWE

## ***TYPE TNASW AND TYPE TNASWE***

- TNASW double-row bearings are a variant of type TNA, having chamfers and slots on the front face of the inner ring.
- TNASWE has an extended inner ring face.
- Slots on the inner ring provide lubrication.
- Cone front faces are extended, eliminating the need for a separate cone spacer.
- TNASW and TNASWE bearings are supplied with a built-in clearance, which results in a specified mounted setting range satisfactory for most applications.
- Types TNASW and TNASWE provide a solution for fixed or floating bearing applications.
- Consult your Timken engineer before making a final bearing selection to help ensure suitability, availability and the most cost-effective solution.



**Type TNASW**

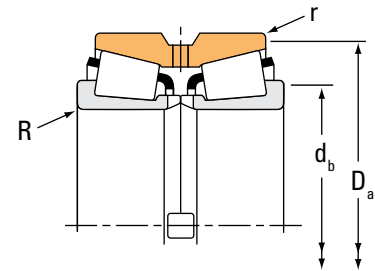
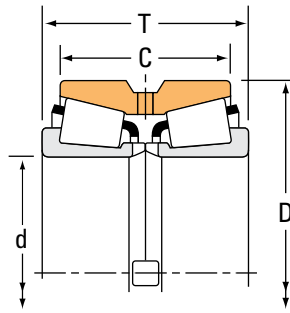


**Type TNASWE**

# TAPERED ROLLER BEARINGS

## DOUBLE-ROW • TYPE TNASW

### TYPE TNASW



Bearing Dimensions				Load Ratings							
Bore d	O.D. D	Width T	Double Outer Ring Width C	Dynamic <sup>(1)</sup>				Dynamic <sup>(3)</sup>			
				C <sub>1(2)</sub>	e	Factors <sup>(2)</sup> Y <sub>1</sub>	Y <sub>2</sub>	C <sub>90</sub>	C <sub>a90</sub>	C <sub>90(2)</sub>	Factors <sup>(2)</sup> K
mm in.	mm in.	mm in.	mm in.	N lbf				N lbf	N lbf	N lbf	
29.987 1.1806	71.973 2.8336	42.760 1.6835	36.512 1.4375	121000 27300	0.36	1.87	2.79	18100 4060	11100 2500	31400 7070	1.62
44.450 1.7500	95.250 3.7500	61.915 2.4376	50.800 2.0000	221000 49700	0.28	2.37	3.53	32900 7400	16000 3600	57300 12900	2.05
50.800 2.0000	93.264 3.6718	65.088 2.5625	52.388 2.0625	213000 47800	0.34	1.99	2.97	31700 7120	18300 4120	55100 12400	1.73
50.800 2.0000	107.950 4.2500	65.090 2.5626	53.975 2.1250	236000 53100	0.34	2.01	3.00	35200 7900	20200 4540	61200 13800	1.74
53.975 2.1250	127.000 5.0000	69.850 2.7500	68.265 2.6876	226000 50800	0.33	2.05	3.05	33600 7560	19000 4270	58600 13200	1.77
60.325 2.3750	123.825 4.8750	79.375 3.1250	63.500 2.5000	332000 74700	0.35	1.95	2.90	49400 11100	29300 6590	86100 19400	1.69
69.850 2.7500	136.525 5.3750	95.250 3.7500	76.200 3.0000	406000 91200	0.36	1.86	2.78	60400 13600	37400 8420	105000 23600	1.61
70.000 2.7559	120.000 4.7244	65.090 2.5626	53.975 2.1250	250000 56100	0.38	1.75	2.61	37200 8360	24500 5500	64700 14600	1.52
76.200 3.0000	136.525 5.3750	69.850 2.7500	53.975 2.1250	269000 60500	0.44	1.52	2.26	40000 9000	30500 6850	69700 15700	1.31
76.200 3.0000	152.400 6.0000	95.250 3.7500	76.200 3.0000	430000 96700	0.41	1.65	2.46	64000 14400	44800 10100	112000 25100	1.43
85.725 3.3750	136.525 5.3750	73.025 2.8750	53.975 2.1250	254000 57100	0.44	1.52	2.26	37800 8500	28800 6470	65800 14800	1.31
88.900 3.5000	152.400 6.0000	82.550 3.2500	63.500 2.5000	376000 84600	0.44	1.53	2.27	56000 12600	42400 9530	97500 21900	1.32
88.900 3.5000	161.925 6.3750	104.775 4.1250	85.725 3.3750	570000 128000	0.34	1.98	2.95	84800 19100	49500 11100	148000 33200	1.71
95.250 3.7500	180.000 7.0866	104.775 4.1250	85.725 3.3750	603000 135000	0.39	1.75	2.61	89700 20200	59200 13300	156000 35100	1.51
95.250 3.7500	180.975 7.1250	104.775 4.1250	85.725 3.3750	603000 135000	0.39	1.75	2.61	89700 20200	59200 13300	156000 35100	1.51
101.600 4.0000	168.275 6.6250	92.075 3.6250	69.850 2.7500	461000 104000	0.47	1.43	2.14	68600 15400	55300 12400	119000 26900	1.24
234.950 9.2500	325.438 12.8125	107.950 4.2500	76.200 3.0000	929000 209000	0.33	2.02	3.01	138000 31100	79200 17800	241000 54200	1.75

<sup>(1)</sup>Based on 1 x 10<sup>6</sup> revolutions L<sub>10</sub> life, for the ISO life-calculation method. C<sub>1(2)</sub> is the double-row radial value.

<sup>(2)</sup>Consult your Timken engineer for instructions on use or review the Timken Engineering Manual on [timken.com/catalogs](http://timken.com/catalogs).

<sup>(3)</sup>Based on 90 x 10<sup>6</sup> revolutions L<sub>10</sub> life, for The Timken Company life-calculation method. C<sub>90</sub> and C<sub>a90</sub> are radial and thrust values for a single row. C<sub>90(2)</sub> is the double-row radial value.

Part Number		Dimensions				Bearing Weight
Inner	Outer	Shaft		Housing		
		Max Shaft Fillet Radius R <sup>(4)</sup>	Backing Shoulder Dia. d <sub>b</sub>	Max Housing Fillet Radius r <sup>(4)</sup>	Backing Shoulder Dia. D <sub>a</sub>	
		mm in.	mm in.	mm in.	mm in.	kg lbs.
NA26118SW	26284D	1.5 0.06	38.0 1.50	0.8 0.03	65.0 2.56	0.84 1.86
NA438SW	432D	3.5 0.14	57.0 2.24	0.8 0.03	87.0 3.43	2.00 4.40
NA3780SW	3729D	3.5 0.14	64.0 2.52	0.8 0.03	87.9 3.46	1.81 3.99
NA455SW	452D	3.5 0.14	65.0 2.56	0.8 0.03	100.0 3.94	2.80 6.20
NA33895SW	K302667	3.5 0.14	67.0 2.64	6.4 0.25	93.0 3.66	4.83 10.64
NA558SW	552D	3.5 0.14	76.0 2.99	1.5 0.06	115.0 4.53	4.33 9.57
NA643SW	632D	3.5 0.14	86.0 3.39	1.5 0.06	125.0 4.92	5.92 13.01
NA484SW	472D	3.5 0.14	83.0 3.27	0.8 0.03	114.0 4.49	2.91 6.39
NA495SW	493D	3.5 0.14	92.0 3.62	0.8 0.03	130.0 5.12	4.08 8.97
NA659SW	654D	3.5 0.14	93.0 3.66	1.5 0.06	141.0 5.55	7.63 16.83
NA497SW	493D	3.5 0.14	99.0 3.90	0.8 0.03	130.0 5.12	3.56 7.84
NA593SW	592D	3.5 0.14	104.0 4.09	0.8 0.03	144.0 5.67	5.81 12.82
NA759SW	752D	3.5 0.14	106.0 4.17	1.5 0.06	150.0 5.91	8.80 19.38
NA776SW	773D	3.5 0.14	114.0 4.49	0.8 0.03	168.0 6.61	11.49 25.34
NA776SW	774D	3.5 0.14	114.0 4.49	1.5 0.06	168.0 6.61	11.44 25.21
NA691SW	672D	3.5 0.14	118.0 4.65	0.8 0.03	160.0 6.30	7.82 17.23
LM246349NW	LM246310D	3.5 0.14	252.0 9.92	1.5 0.06	312.0 12.28	23.01 50.70

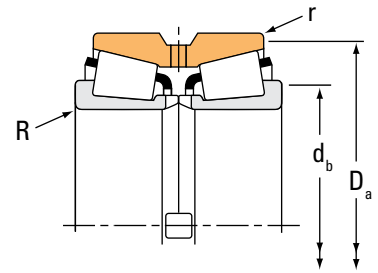
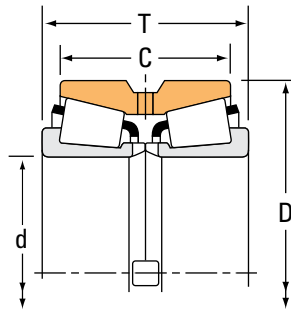
<sup>(4)</sup>These maximum fillet radii will be cleared by bearing corners.

NOTE: For desired fitting practice and resultant mounted setting range information, contact your Timken engineer.

# TAPERED ROLLER BEARINGS

## DOUBLE-ROW TYPE TNASW

### TYPE TNASW



Bearing Dimensions				Load Ratings							
Bore d	O.D. D	Width T	Double Outer Ring Width C	Dynamic <sup>(1)</sup>				Dynamic <sup>(3)</sup>			
				C <sub>1(2)</sub>	e	Y <sub>1</sub>	Y <sub>2</sub>	C <sub>90</sub>	C <sub>a90</sub>	C <sub>90(2)</sub>	K
mm in.	mm in.	mm in.	mm in.	N lbf				N lbf	N lbf	N lbf	
303.886 11.9640	419.100 16.5000	161.925 6.3750	129.540 5.1000	2060000 464000	0.52	1.30	1.94	307000 69100	273000 61400	535000 120000	1.13
304.800 12.0000	419.100 16.5000	161.925 6.3750	129.540 5.1000	2060000 464000	0.52	1.30	1.94	307000 69100	273000 61400	535000 120000	1.13
355.600 14.0000	444.500 17.5000	136.525 5.3750	111.125 4.3750	1280000 287000	0.31	2.20	3.27	190000 42700	100000 22500	331000 74400	1.90

<sup>(1)</sup>Based on  $1 \times 10^6$  revolutions  $L_{10}$  life, for the ISO life-calculation method.  $C_{1(2)}$  is the double-row radial value.

<sup>(2)</sup>Consult your Timken engineer for instructions on use or review the Timken Engineering Manual on [timken.com/catalogs](http://timken.com/catalogs).

<sup>(3)</sup>Based on  $90 \times 10^6$  revolutions  $L_{10}$  life, for The Timken Company life-calculation method.  $C_{90}$  and  $C_{a90}$  are radial and thrust values for a single-row.  $C_{90(2)}$  is the double-row radial value.



Part Number		Dimensions				Bearing Weight
Inner	Outer	Shaft		Housing		
		Max Shaft Fillet Radius R <sup>(4)</sup>	Backing Shoulder Dia. d <sub>b</sub>	Max Housing Fillet Radius r <sup>(4)</sup>	Backing Shoulder Dia. D <sub>a</sub>	
		mm in.	mm in.	mm in.	mm in.	kg lbs.
NP446605	NP930308	<b>6.4</b> 0.25	<b>336.0</b> 13.23	<b>1.5</b> 0.06	<b>406.9</b> 16.02	<b>64.32</b> 141.79
NP633856	NP930308	<b>6.4</b> 0.25	<b>336.0</b> 13.23	<b>1.5</b> 0.06	<b>406.9</b> 16.02	<b>63.76</b> 140.57
L163149NW	L163110CD	<b>3.5</b> 0.14	<b>374.0</b> 14.72	<b>1.5</b> 0.06	<b>430.0</b> 16.93	<b>44.96</b> 99.12

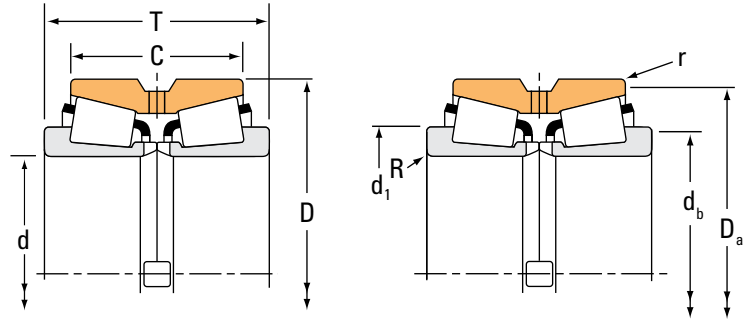
<sup>(4)</sup>These maximum fillet radii will be cleared by bearing corners.

NOTE: For desired fitting practice and resultant mounted setting range information, contact your Timken engineer.

# TAPERED ROLLER BEARINGS

## DOUBLE-ROW • TYPE TNASWE

### TYPE TNASWE



Bearing Dimensions				Load Ratings							
Bore d	O.D. D	Width T	Double Outer Ring Width C	Dynamic <sup>(1)</sup>				Dynamic <sup>(3)</sup>			
				C <sub>1(2)</sub>	e	Factors <sup>(2)</sup> Y <sub>1</sub>	Y <sub>2</sub>	C <sub>90</sub>	C <sub>a90</sub>	C <sub>90(2)</sub>	Factors <sup>(2)</sup> K
mm in.	mm in.	mm in.	mm in.	N lbf				N lbf	N lbf	N lbf	
19.050 0.7500	47.000 1.8504	34.925 1.3750	25.212 0.9926	46500 10500	0.36	1.89	2.82	6930 1560	4230 952	12100 2710	1.64
30.000 1.1811	63.500 2.5000	50.752 1.9981	36.512 1.4375	88000 19800	0.35	1.93	2.87	13100 2940	7860 1770	22800 5130	1.67
30.005 1.1813	63.500 2.5000	50.800 2.0000	36.512 1.4375	88000 19800	0.35	1.93	2.87	13100 2940	7860 1770	22800 5130	1.67
38.100 1.5000	76.200 3.0000	58.738 2.3125	39.688 1.5625	132000 29600	0.39	1.72	2.56	19600 4400	13200 2960	34100 7670	1.49
44.450 1.7500	95.250 3.7500	71.440 2.8126	50.800 2.0000	221000 49700	0.28	2.37	3.53	32900 7400	16000 3600	57300 12900	2.05
50.800 2.0000	107.950 4.2500	74.615 2.9376	53.975 2.1250	236000 53100	0.34	2.01	3.00	35200 7900	20200 4540	61200 13800	1.74
70.000 2.7559	120.000 4.7244	74.615 2.9376	53.975 2.1250	250000 56100	0.38	1.75	2.61	37200 8360	24500 5500	64700 14600	1.52
82.550 3.2500	139.992 5.5115	92.075 3.6250	66.675 2.6250	360000 80900	0.40	1.67	2.49	53600 12100	37100 8330	93400 21000	1.45
88.900 3.5000	152.400 6.0000	92.075 3.6250	63.500 2.5000	376000 84600	0.44	1.53	2.27	56000 12600	42400 9530	97500 21900	1.32
99.975 3.9360	164.975 6.4951	88.900 3.5000	63.500 2.5000	394000 88600	0.50	1.36	2.02	58700 13200	50000 11200	102000 23000	1.18
107.950 4.2500	165.100 6.5000	88.900 3.5000	63.500 2.5000	394000 88600	0.50	1.36	2.02	58700 13200	50000 11200	102000 23000	1.18
109.975 4.3297	179.975 7.0856	101.600 4.0000	69.850 2.7500	443000 99600	0.52	1.31	1.95	65900 14800	58300 13100	115000 25800	1.13
127.000 5.0000	182.562 7.1875	93.660 3.6874	73.025 2.8750	466000 105000	0.31	2.21	3.29	69400 15600	36300 8160	121000 27200	1.91
142.875 5.6250	200.025 7.8750	93.665 3.6876	73.025 2.8750	499000 112000	0.34	2.01	2.99	74300 16700	42800 9610	129000 29100	1.74
152.400 6.0000	211.138 8.3125	92.075 3.6250	69.850 2.7500	508000 114000	0.36	1.89	2.82	75600 17000	46200 10400	132000 29600	1.64
165.100 6.5000	225.425 8.8750	95.250 3.7500	69.850 2.7500	528000 119000	0.38	1.76	2.62	78600 17700	51600 11600	137000 30800	1.52
177.800 7.0000	282.575 11.1250	107.950 4.2500	79.375 3.1250	886000 199000	0.42	1.62	2.42	132000 29700	93900 21100	230000 51700	1.41

<sup>(1)</sup>Based on  $1 \times 10^6$  revolutions  $L_{10}$  life, for the ISO life-calculation method.  $C_{1(2)}$  is the double-row radial value.

<sup>(2)</sup>Consult your Timken engineer for instructions on use or review the Timken Engineering Manual on [timken.com/catalogs](http://timken.com/catalogs).

<sup>(3)</sup>Based on  $90 \times 10^6$  revolutions  $L_{10}$  life, for The Timken Company life-calculation method.  $C_{90}$  and  $C_{a90}$  are radial and thrust values for a single row.  $C_{90(2)}$  is the double-row radial value.

Part Number		Dimensions					Bearing Weight
Inner	Outer	Bearing	Shaft		Housing		
		Outside Dia. (rib) d <sub>1</sub> <sup>(4)</sup>	Max Shaft Fillet Radius R <sup>(5)</sup>	Backing Shoulder Dia. d <sub>b</sub>	Max Housing Fillet Radius r <sup>(5)</sup>	Backing Shoulder Dia. D <sub>a</sub>	
			mm in.	mm in.	mm in.	mm in.	kg lbs.
NA05076SW	05185D	<b>32.362</b> 1.2741	<b>0.8</b> 0.03	<b>24.0</b> 0.94	<b>0.8</b> 0.03	<b>42.5</b> 1.67	<b>0.26</b> 0.595
NA15118SW	15251D	<b>45.763</b> 1.8017	<b>3.5</b> 0.14	<b>41.0</b> 1.61	<b>0.8</b> 0.03	<b>59.0</b> 2.32	<b>0.73</b> 1.599
NA15117SW	15251D	<b>45.763</b> 1.8017	<b>0.8</b> 0.03	<b>35.5</b> 1.40	<b>0.8</b> 0.03	<b>59.0</b> 2.32	<b>0.73</b> 1.605
NA24776SW	24720D	<b>58.25</b> 2.2933	<b>0.8</b> 0.03	<b>45.0</b> 1.77	<b>0.8</b> 0.03	<b>72.0</b> 2.83	<b>1.15</b> 2.543
NA435SW	432D	<b>65.019</b> 2.5598	<b>3.5</b> 0.14	<b>57.0</b> 2.24	<b>0.8</b> 0.03	<b>87.0</b> 3.43	<b>2.12</b> 4.691
NA456SW	452D	<b>79.098</b> 3.1141	<b>3.5</b> 0.14	<b>65.0</b> 2.56	<b>0.8</b> 0.03	<b>100.0</b> 3.94	<b>3.02</b> 6.649
NA483SW	472D	<b>92.812</b> 3.654	<b>3.5</b> 0.14	<b>83.0</b> 3.27	<b>0.8</b> 0.03	<b>114.0</b> 4.49	<b>3.11</b> 6.877
NA580SW	572D	<b>109.802</b> 4.3229	<b>3.5</b> 0.14	<b>98.0</b> 3.86	<b>0.8</b> 0.03	<b>133.0</b> 5.24	<b>4.87</b> 10.758
NA596SW	592D	<b>121.222</b> 4.7725	<b>3.5</b> 0.14	<b>104.0</b> 4.09	<b>0.8</b> 0.03	<b>144.0</b> 5.67	<b>5.97</b> 13.148
NA56393SW	56649D	<b>137.792</b> 5.4249	<b>3.5</b> 0.14	<b>117.0</b> 4.61	<b>0.8</b> 0.03	<b>159.0</b> 6.26	<b>7.22</b> 15.899
NA56425SW	56650D	<b>137.792</b> 5.4249	<b>3.5</b> 0.14	<b>123.0</b> 4.84	<b>0.8</b> 0.03	<b>159.0</b> 6.26	<b>6.31</b> 13.928
NA64432SW	64708D	<b>146.545</b> 5.7695	<b>3.5</b> 0.14	<b>128.0</b> 5.04	<b>0.8</b> 0.03	<b>173.0</b> 6.81	<b>9.25</b> 20.385
NA48290SW	48220D	<b>155.13</b> 6.1075	<b>3.5</b> 0.14	<b>141.0</b> 5.55	<b>0.8</b> 0.03	<b>176.0</b> 6.93	<b>7.63</b> 16.839
NA48685SW	48620D	<b>172.001</b> 6.7717	<b>3.5</b> 0.14	<b>158.0</b> 6.22	<b>0.8</b> 0.03	<b>193.0</b> 7.60	<b>8.43</b> 18.579
NA48990SW	48920D	<b>183.096</b> 7.2085	<b>3.5</b> 0.14	<b>168.0</b> 6.61	<b>0.8</b> 0.03	<b>204.0</b> 8.03	<b>9.26</b> 20.399
NA46790SW	46720CD	<b>197.104</b> 7.76	<b>3.5</b> 0.14	<b>181.0</b> 7.13	<b>0.8</b> 0.03	<b>218.0</b> 8.58	<b>10.44</b> 23.006
NA87700SW	87112D	<b>233.213</b> 9.1816	<b>3.5</b> 0.14	<b>200.0</b> 7.87	<b>1.5</b> 0.06	<b>267.0</b> 10.50	<b>22.95</b> 50.585

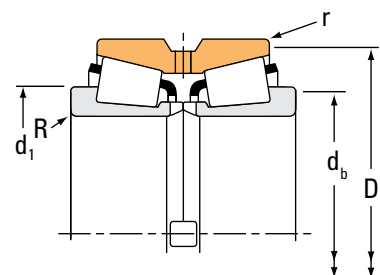
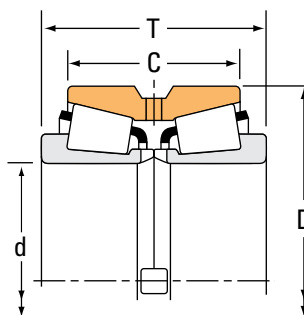
<sup>(4)</sup>Tolerance +0 +127 µm, +0 +0.005 in.

<sup>(5)</sup>These maximum fillet radii will be cleared by bearing corners.

# TAPERED ROLLER BEARINGS

## DOUBLE-ROW • TYPE TNASWE

### TYPE TNASWE



Bearing Dimensions				Load Ratings							
Bore d	O.D. D	Width T	Double Outer Ring Width C	Dynamic <sup>(1)</sup>				Dynamic <sup>(3)</sup>			
				C <sub>1(2)</sub>	e	Factors <sup>(2)</sup> Y <sub>1</sub>	Y <sub>2</sub>	C <sub>90</sub>	C <sub>a90</sub>	C <sub>90(2)</sub>	Factors <sup>(2)</sup> K
mm in.	mm in.	mm in.	mm in.	N lbf				N lbf	N lbf	N lbf	
184.150 7.2500	242.888 9.5625	95.250 3.7500	69.850 2.7500	541000 122000	0.42	1.61	2.40	80600 18100	57800 13000	140000 31600	1.39
190.500 7.5000	266.700 10.5000	109.538 4.3125	84.138 3.3125	725000 163000	0.48	1.41	2.11	108000 24300	88200 19800	188000 42300	1.22
203.200 8.0000	276.225 10.8750	95.250 3.7500	73.025 2.8750	764000 172000	0.32	2.12	3.15	114000 25600	62100 14000	198000 44500	1.83
234.950 9.2500	311.150 12.2500	101.600 4.0000	73.025 2.8750	768000 173000	0.36	1.86	2.77	114000 25700	70900 15900	199000 44800	1.61
244.475 9.6250	349.148 13.7460	133.350 5.2500	101.600 4.0000	1150000 258000	0.35	1.91	2.85	171000 38500	103000 23300	298000 67000	1.65
253.975 9.9990	347.662 13.6875	101.600 4.0000	69.850 2.7500	1070000 240000	0.33	2.03	3.02	159000 35700	90500 20300	277000 62200	1.76
260.350 10.2500	400.050 15.7500	146.050 5.7500	107.950 4.2500	1440000 324000	0.39	1.71	2.55	215000 48200	145000 32600	374000 84000	1.48
266.700 10.5000	352.425 13.8750	107.950 4.2500	82.550 3.2500	985000 221000	0.32	2.12	3.15	147000 33000	80100 18000	255000 57400	1.83
304.800 12.0000	393.700 15.5000	107.950 4.2500	82.550 3.2500	1020000 229000	0.36	1.88	2.80	152000 34200	93500 21000	265000 59500	1.63

<sup>(1)</sup>Based on  $1 \times 10^6$  revolutions  $L_{10}$  life, for the ISO life-calculation method.  $C_{1(2)}$  is the double-row radial value.

<sup>(2)</sup>Consult your Timken engineer for instructions on use or review the Timken Engineering Manual on [timken.com/catalogs](http://timken.com/catalogs).

<sup>(3)</sup>Based on  $90 \times 10^6$  revolutions  $L_{10}$  life, for The Timken Company life-calculation method.  $C_{90}$  and  $C_{a90}$  are radial and thrust values for a single row.  $C_{90(2)}$  is the double-row radial value.

Part Number		Dimensions					Bearing Weight
Inner	Outer	Bearing	Shaft		Housing		
		Outside Dia. (rib) d <sub>1</sub> <sup>(4)</sup>	Max Shaft Fillet Radius R <sup>(5)</sup>	Backing Shoulder Dia. d <sub>b</sub>	Max Housing Fillet Radius r <sup>(5)</sup>	Backing Shoulder Dia. D <sub>a</sub>	
			mm in.	mm in.	mm in.	mm in.	kg lbs.
LM637349NW	LM637310D	<b>215.4</b> 8.4803	<b>3.5</b> 0.14	<b>199.0</b> 7.83	<b>0.8</b> 0.03	<b>236.0</b> 9.29	<b>10.98</b> 24.210
NA67885SW	67820CD	<b>232.268</b> 9.1444	<b>3.5</b> 0.14	<b>209.0</b> 8.23	<b>0.8</b> 0.03	<b>259.0</b> 10.20	<b>17.74</b> 39.083
LM241149NW	LM241110D	<b>240.434</b> 9.4659	<b>3.5</b> 0.14	<b>220.0</b> 8.66	<b>0.8</b> 0.03	<b>267.0</b> 10.51	<b>15.02</b> 33.114
LM446349NW	LM446310D	<b>274.716</b> 10.8156	<b>3.5</b> 0.14	<b>252.0</b> 9.92	<b>0.8</b> 0.03	<b>301.0</b> 11.85	<b>18.63</b> 41.085
NA127096SW	127136CD	<b>290.452</b> 11.4351	<b>6.4</b> 0.25	<b>269.0</b> 10.59	<b>1.5</b> 0.06	<b>329.0</b> 12.95	<b>34.95</b> 77.015
LM249747NW	LM249710CD	<b>294.284</b> 11.586	<b>3.5</b> 0.14	<b>272.0</b> 10.71	<b>1.5</b> 0.06	<b>333.0</b> 13.11	<b>23.62</b> 52.075
NA221027SW	221576CD	<b>323.131</b> 12.7217	<b>6.4</b> 0.25	<b>290.0</b> 11.42	<b>1.5</b> 0.06	<b>371.5</b> 14.63	<b>58.77</b> 129.541
LM251649NW	LM251610D	<b>309.865</b> 12.1994	<b>6.4</b> 0.25	<b>291.0</b> 11.46	<b>1.5</b> 0.06	<b>340.0</b> 13.39	<b>26.60</b> 58.626
L357049NW	L357010CD	<b>350.446</b> 13.7971	<b>6.4</b> 0.25	<b>329.0</b> 12.95	<b>1.5</b> 0.06	<b>380.0</b> 14.96	<b>30.19</b> 66.565

<sup>(4)</sup>Tolerance +0 +127 μm, +0 +0.005 in.

<sup>(5)</sup>These maximum fillet radii will be cleared by bearing corners.



## SPACER ASSEMBLIES

- Any two matching single-row bearings (type TS) can be supplied as a double-row, pre-set, ready-to-fit assembly by the addition of spacers, machined to pre-determined dimensions and tolerances.
- There are two basic mounting arrangements for single-row spacer assemblies:



2TS-IM



- Type 2TS-IM (indirect mounting)**  
These consist of two single-row bearings with an inner-ring and outer-ring spacer. In some applications, the outer-ring spacer is replaced by a shoulder in the bearing housing.

2TS-DM



- Type 2TS-DM (direct mounting)**  
These consist of two single-row bearings, with cone (inner-ring) backfaces abutting and an outer-ring spacer. They are generally used at fixed (locating) positions on rotating shaft applications.

- Along with the standard 2TS types, there are two specialty double-row assemblies available:

2S

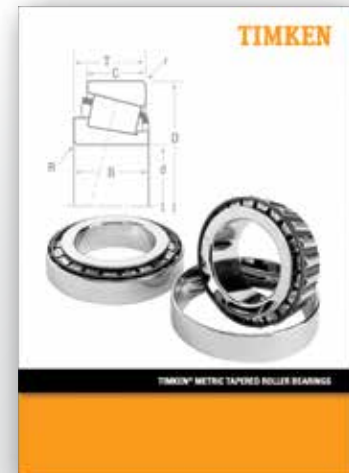


- Type 2S - Two single-row assembly**  
Supplied complete with inner-ring and outer-ring spacers to give a pre-determined bearing setting when assembled. The setting range can be specified to suit the application. Type 2S has an inner-ring spacer and a snap-ring, which also serves as the cup spacer, to give axial location in a through-bored housing.

SR



- Type SR - Set-Right assembly**  
Type SR is made to a standard setting range, based on Timken's Set-Right automated setting technique, suitable for most industrial applications. It is equipped with two spacers and an optional snap-ring that may be used for axial location.

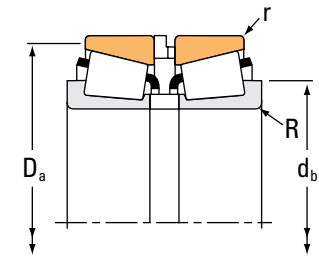
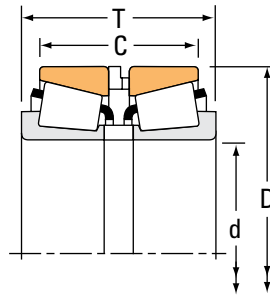


*For a complete listing of Timken® Metric Tapered Roller Bearings Matched Bearing Assemblies, see catalog order no. E0401 GB on [www.timken.com/catalogs](http://www.timken.com/catalogs).*

# TAPERED ROLLER BEARINGS

## DOUBLE-ROW • TYPE 2TS-IM

### TYPE 2TS-IM



Bearing Dimensions				Load Ratings							
Bore d	O.D. D	Width <sup>(1)</sup> T	Width C	Dynamic <sup>(2)</sup>				Dynamic <sup>(4)</sup>			
				C <sub>1(2)</sub>	e	Factors <sup>(3)</sup> Y <sub>1</sub>	Y <sub>2</sub>	C <sub>90</sub>	C <sub>a90</sub>	C <sub>90(2)</sub>	Factors <sup>(3)</sup> K
mm in.	mm in.	mm in.	mm in.	N lbf				N lbf	N lbf	N lbf	
21.987 0.8656	45.975 1.8100	34.950 1.3760	28.092 1.1060	67200 15100	0.31	2.21	3.28	10000 2250	5250 1180	17400 3920	1.91
28.575 1.1250	68.262 2.6875	49.425 1.9459	39.901 1.5709	133000 29900	0.55	1.24	1.84	19800 4450	18500 4160	34400 7740	1.07
30.000 1.1811	72.000 2.8346	78.740 3.1000	66.040 2.6000	180000 40400	0.55	1.24	1.84	26700 6010	25000 5620	46600 10500	1.07
34.925 1.3750	76.073 2.9950	56.337 2.2180	44.614 1.7565	134000 30100	0.55	1.24	1.84	19900 4480	18600 4180	34700 7790	1.07
34.987 1.3775	59.975 2.3612	35.712 1.4060	27.838 1.0960	79200 17800	0.42	1.62	2.42	11800 2650	8400 1890	20500 4620	1.40
35.000 1.3780	62.000 2.4409	40.575 1.5974	32.575 1.2825	98400 22100	0.45	1.49	2.21	14600 3290	11400 2560	25500 5730	1.29
38.000 1.4961	63.000 2.4803	37.810 1.4886	30.810 1.2130	88800 20000	0.42	1.62	2.42	13200 2970	9410 2120	23000 5170	1.40
38.100 1.5000	79.375 3.1250	63.515 2.5006	52.400 2.0630	182000 41000	0.37	1.85	2.75	27100 6100	17000 3820	47200 10600	1.60
38.100 1.5000	85.725 3.3750	67.183 2.6450	54.483 2.1450	216000 48600	0.40	1.68	2.50	32200 7240	22200 4980	56100 12600	1.45
38.100 1.5000	85.725 3.3750	101.600 4.0000	88.900 3.5000	216000 48600	0.40	1.68	2.50	32200 7240	22200 4980	56100 12600	1.45
39.688 1.5625	80.035 3.1510	87.315 3.4376	76.200 3.0000	200000 45000	0.27	2.47	3.68	29800 6700	13900 3130	51900 11700	2.14
40.000 1.5748	88.500 3.4843	63.602 2.5040	54.077 2.1290	201000 45300	0.26	2.56	3.81	30000 6740	13500 3040	52200 11700	2.22
40.483 1.5938	82.550 3.2500	63.058 2.4826	50.358 1.9826	179000 40200	0.55	1.24	1.84	26600 5980	24900 5590	46400 10400	1.07
41.275 1.6250	73.431 2.8910	42.672 1.6800	33.020 1.3000	130000 29300	0.40	1.69	2.52	19400 4360	13300 2980	33800 7590	1.46
41.275 1.6250	82.550 3.2500	61.087 2.4050	48.387 1.9050	160000 35900	0.55	1.24	1.84	23800 5340	22200 4990	41400 9300	1.07
41.275 1.6250	85.725 3.3750	66.675 2.6250	53.975 2.1250	216000 48600	0.40	1.68	2.50	32200 7240	22200 4980	56100 12600	1.45
42.070 1.6563	90.488 3.5625	87.376 3.4400	74.676 2.9400	346000 77700	0.28	2.37	3.53	51500 11600	25100 5640	89700 20200	2.05

<sup>(1)</sup>Overall width can vary depending on spacer selection. Contact your Timken engineer for more information.

<sup>(2)</sup>Based on  $1 \times 10^6$  revolutions  $L_{10}$  life, for the ISO life-calculation method.  $C_{1(2)}$  is the double-row radial value.

<sup>(3)</sup>Consult your Timken engineer for instructions on use or review the Timken Engineering Manual on [timken.com/catalogs](http://timken.com/catalogs).

<sup>(4)</sup>Based on  $90 \times 10^6$  revolutions  $L_{10}$  life, for The Timken Company life-calculation method.  $C_{90}$  and  $C_{a90}$  are radial and thrust values for single-row.

$C_{90(2)}$  is the double-row radial value.



Part Number				Dimensions				Bearing Weight
Inner	Outer	Inner Spacer <sup>(5)</sup>	Outer Spacer <sup>(5)</sup>	Shaft		Housing		
				Max. Shaft Fillet Radius R <sup>(6)</sup>	Backing Shoulder Dia. d <sub>b</sub>	Max. Housing Fillet Radius r <sup>(6)</sup>	Backing Shoulder Dia. D <sub>a</sub>	
				mm in.	mm in.	mm in.	mm in.	kg lbs.
LM12749	LM12711	K523966R		1.3 0.05	27.5 1.08	0.4 0.02	42.5 1.67	0.25 0.57
M88040A	M88010	M88040XA		0.3 0.01	40.0 1.57	0.4 0.02	65.0 2.56	0.84 1.89
JHM88540	JHM88513	K160075		1.3 0.05	44.5 1.75	0.3 0.01	69.0 2.72	1.27 2.84
HM88649	HM88610	HM88649XB	XC2360-SA	2.3 0.09	48.5 1.91	0.4 0.02	69.0 2.72	1.04 2.31
L68149	L68111	K154145R	L68111EC	3.5 0.14	45.5 1.79	0.4 0.02	56.0 2.20	0.38 0.83
X32007X	Y32007X	JX3505A	JYH6205R	1.0 0.04	43.0 1.69	0.1 0.01	59.5 2.34	0.49 1.09
JL69349	JL69310	K158596R	K158598R	0.4 0.02	46.5 1.83	0.3 0.01	60.0 2.36	0.44 0.96
3490	3420	X1S-28150		3.5 0.14	52.0 2.05	0.8 0.03	74.0 2.91	1.32 2.93
3876	3820	X1S-25572		3.5 0.14	55.0 2.17	0.8 0.03	81.0 3.19	1.71 3.78
3875	3821	X1S-3875	Y1S-3821	0.8 0.03	49.5 1.95	0.8 0.03	81.0 3.19	2.33 5.11
3382	3339	X1S-3382		3.5 0.14	52.0 2.05	0.8 0.03	74.8 2.94	1.40 3.10
420	414	K143256R	Y1H414	3.5 0.14	52.0 2.05	0.8 0.03	80.0 3.15	1.75 3.84
HM801349	HM801310	HM801349XA		3.5 0.14	58.0 2.28	0.5 0.02	78.0 3.07	1.46 3.25
LM501349	LM501310	K143254	LM501310ES	3.5 0.14	54.0 2.13	0.5 0.02	70.0 2.76	0.73 1.59
M802048	M802011	K165354	K165355	3.5 0.14	57.0 2.24	0.5 0.02	79.0 3.11	1.35 3.00
3880	3820	X1S-3880	Y7S-3820	0.8 0.03	52.0 2.05	0.8 0.03	81.0 3.19	1.71 3.76
4395	4335	X1S-4395	Y1S-4335	3.5 0.14	60.0 2.36	0.8 0.03	85.0 3.35	2.60 5.74

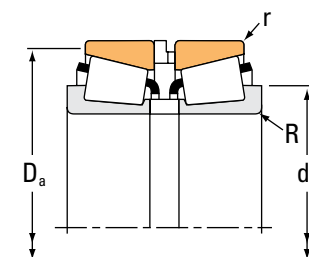
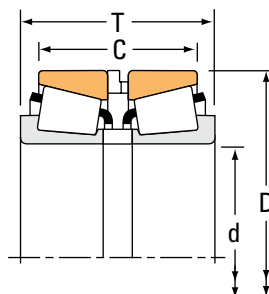
<sup>(5)</sup>Contact your Timken engineer for information on spacer configurations.

<sup>(6)</sup>These maximum fillet radii will be cleared by the bearing corners.

# TAPERED ROLLER BEARINGS

## DOUBLE-ROW • TYPE 2TS-IM

### TYPE 2TS-IM



Bearing Dimensions				Load Ratings							
Bore d	O.D. D	Width <sup>(1)</sup> T	Width C	Dynamic <sup>(2)</sup>		Factors <sup>(3)</sup>		Dynamic <sup>(4)</sup>			Factors <sup>(3)</sup>
mm in.	mm in.	mm in.	mm in.	C <sub>1(2)</sub>	e	Y <sub>1</sub>	Y <sub>2</sub>	C <sub>90</sub>	C <sub>a90</sub>	C <sub>90(2)</sub>	K
N lbf	N lbf	N lbf	N lbf								
42.875 1.6880	80.167 3.1562	55.560 2.1874	46.035 1.8124	159000 35700	0.32	2.12	3.15	23600 5310	12900 2900	41100 9240	1.83
44.450 1.7500	95.250 3.7500	74.615 2.9376	57.150 2.2500	237000 53400	0.74	0.91	1.36	35400 7950	44800 10100	61600 13800	0.79
44.987 1.7712	104.986 4.1333	69.342 2.7300	51.054 2.0100	234000 52700	0.78	0.86	1.29	34900 7850	46700 10500	60800 13700	0.75
45.242 1.7812	77.788 3.0625	43.647 1.7184	34.122 1.3434	133000 29900	0.43	1.58	2.35	19800 4450	14500 3250	34400 7740	1.37
45.242 1.7812	77.788 3.0625	44.247 1.7420	34.722 1.3670	133000 29900	0.43	1.58	2.35	19800 4450	14500 3250	34400 7740	1.37
45.242 1.7812	77.788 3.0625	46.822 1.8434	37.297 1.4684	133000 29900	0.43	1.58	2.35	19800 4450	14500 3250	34400 7740	1.37
49.212 1.9375	114.300 4.5000	95.250 3.7500	76.200 3.0000	389000 87500	0.43	1.57	2.34	58000 13000	42700 9600	101000 22700	1.36
50.000 1.9685	82.000 3.2283	48.428 1.9066	39.426 1.5522	168000 37700	0.31	2.21	3.29	25000 5610	13000 2930	43500 9770	1.91
50.000 1.9685	82.000 3.2283	66.000 2.5984	57.000 2.2441	168000 37700	0.31	2.21	3.29	25000 5610	13000 2930	43500 9770	1.91
50.000 1.9685	90.000 3.5433	50.000 1.9685	40.500 1.5945	150000 33600	0.42	1.61	2.39	22300 5010	16000 3600	38800 8720	1.39
50.000 1.9685	90.000 3.5433	83.287 3.2790	73.287 2.8853	255000 57400	0.33	2.05	3.06	38000 8540	21400 4810	66200 14900	1.78
50.000 1.9685	105.000 4.1339	79.543 3.1316	63.540 2.5016	354000 79600	0.49	1.38	2.06	52700 11900	44000 9890	91800 20600	1.20
50.800 2.0000	82.550 3.2500	51.766 2.0380	41.606 1.6380	168000 37700	0.31	2.21	3.29	25000 5610	13000 2930	43500 9770	1.91
50.800 2.0000	85.000 3.3465	40.640 1.6000	40.640 1.6000	95200 21400	0.41	1.66	2.48	14200 3190	9840 2210	24700 5550	1.44
50.800 2.0000	85.000 3.3465	79.375 3.1250	71.440 2.8126	95200 21400	0.41	1.66	2.48	14200 3190	9840 2210	24700 5550	1.44
50.800 2.0000	92.075 3.6250	55.560 2.1874	46.035 1.8124	172000 38700	0.38	1.79	2.66	25700 5770	16600 3720	44700 10000	1.55
50.800 2.0000	93.264 3.6718	64.287 2.5310	51.587 2.0310	213000 47800	0.34	1.99	2.97	31700 7120	18300 4120	55100 12400	1.73

<sup>(1)</sup>Overall width can vary depending on spacer selection. Contact your Timken engineer for more information.

<sup>(2)</sup>Based on  $1 \times 10^6$  revolutions  $L_{10}$  life, for the ISO life-calculation method.  $C_{1(2)}$  is the double-row radial value.

<sup>(3)</sup>Consult your Timken engineer for instructions on use or review the Timken Engineering Manual on [timken.com/catalogs](http://timken.com/catalogs).

<sup>(4)</sup>Based on  $90 \times 10^6$  revolutions  $L_{10}$  life, for The Timken Company life-calculation method.  $C_{90}$  and  $C_{a90}$  are radial and thrust values for single-row.  $C_{90(2)}$  is the double-row radial value.

Part Number				Dimensions				Bearing Weight
Inner	Outer	Inner Spacer <sup>(5)</sup>	Outer Spacer <sup>(5)</sup>	Shaft		Housing		
				Max. Shaft Fillet Radius R <sup>(6)</sup>	Backing Shoulder Dia. d <sub>b</sub>	Max. Housing Fillet Radius r <sup>(6)</sup>	Backing Shoulder Dia. D <sub>a</sub>	
				mm in.	mm in.	mm in.	mm in.	kg lbs.
26886	26820	X2S-22168	Y3S-26820	1.5 0.06	51.0 2.01	0.8 0.03	74.0 2.91	1.13 2.50
HM903249	HM903210	HM903249XC		3.5 0.14	65.0 2.56	0.6 0.03	91.0 3.58	2.08 4.60
HM905843	HM905810	HM905843XA		2.5 0.10	68.0 2.68	0.8 0.03	100.0 3.94	2.81 6.22
LM603049	LM603011	LM603049XB		3.5 0.14	58.0 2.28	0.4 0.02	74.0 2.91	0.79 1.74
LM603049	LM603011	K109152R		3.5 0.14	58.0 2.28	0.4 0.02	74.0 2.91	0.75 1.65
LM603049	LM603011	LM603049XF	LM603011EX	3.5 0.14	58.0 2.28	0.4 0.02	74.0 2.91	0.80 1.77
65390	65320	X1S-65390	Y1S-65320	3.5 0.14	70.0 2.76	0.8 0.03	107.0 4.21	4.55 10.01
JLM104948	JLM104910	LM104948XB	LM104910ES	3.0 0.12	61.0 2.40	0.4 0.02	78.0 3.07	0.98 2.16
JLM104948	JLM104910	X4S-3780		3.0 0.12	61.0 2.40	0.4 0.02	78.0 3.07	0.96 2.13
X30210UM	Y30210UM	K162853	K162854	1.5 0.06	60.0 2.36	0.8 0.03	86.0 3.39	1.24 2.70
JM205149	JM205110	JX5027A	K154155	3.0 0.12	63.0 2.48	0.5 0.02	85.0 3.35	1.93 4.25
JHM807045	JHM807012	HM807045XA	HM807012ES	3.0 0.12	69.0 2.72	0.8 0.03	100.0 3.94	3.13 6.87
LM104949E	LM104911		LM104911EA	3.5 0.14	62.0 2.44	0.6 0.03	78.0 3.07	0.97 2.11
18790	18720	X4S-18790		3.5 0.14	62.0 2.44	0.8 0.03	80.0 3.15	0.75 1.66
18790	18720	X7S-18790	Y5S-18720	3.5 0.14	62.0 2.44	0.8 0.03	80.0 3.15	0.91 2.02
28580	28523	X1S-28580		3.5 0.14	63.0 2.48	0.8 0.03	87.0 3.43	1.56 3.41
3780	3730	K426900R		3.5 0.14	64.0 2.52	0.8 0.03	88.0 3.46	1.74 3.82

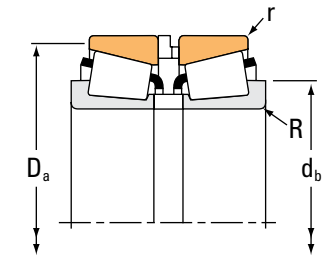
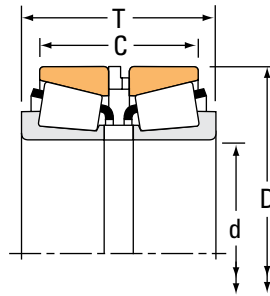
<sup>(5)</sup>Contact your Timken engineer for information on spacer configurations.

<sup>(6)</sup>These maximum fillet radii will be cleared by the bearing corners.

# TAPERED ROLLER BEARINGS

## DOUBLE-ROW • TYPE 2TS-IM

### TYPE 2TS-IM



Bearing Dimensions				Load Ratings							
Bore d	O.D. D	Width <sup>(1)</sup> T	Width C	Dynamic <sup>(2)</sup>				Dynamic <sup>(4)</sup>			
				C <sub>1(2)</sub>	e	Factors <sup>(3)</sup> Y <sub>1</sub>	Y <sub>2</sub>	C <sub>90</sub>	C <sub>a90</sub>	C <sub>90(2)</sub>	Factors <sup>(3)</sup> K
mm in.	mm in.	mm in.	mm in.	N lbf				N lbf	N lbf	N lbf	
50.800 2.0000	101.600 4.0000	78.580 3.0937	62.705 2.4687	287000 64400	0.29	2.37	3.52	42700 9600	20800 4690	74300 16700	2.05
50.800 2.0000	104.775 4.1250	79.375 3.1250	63.500 2.5000	354000 79600	0.49	1.38	2.06	52700 11900	44000 9890	91800 20600	1.20
50.800 2.0000	127.000 5.0000	95.250 3.7500	76.200 3.0000	424000 95300	0.49	1.38	2.06	63100 14200	52700 11800	110000 24700	1.20
55.000 2.1654	90.000 3.5433	51.504 2.0277	42.504 1.6733	190000 42600	0.40	1.68	2.50	28200 6340	19400 4370	49100 11000	1.45
55.000 2.1654	95.000 3.7402	63.418 2.4968	52.418 2.0637	227000 51100	0.33	2.02	3.00	33800 7610	19400 4360	58900 13200	1.74
55.000 2.1654	95.000 3.7402	66.152 2.6044	55.154 2.1714	227000 51100	0.33	2.02	3.00	33800 7610	19400 4360	58900 13200	1.74
55.000 2.1654	95.000 3.7402	76.200 3.0000	65.200 2.5670	227000 51100	0.33	2.02	3.00	33800 7610	19400 4360	58900 13200	1.74
55.000 2.1654	100.000 3.9370	64.600 2.5433	53.100 2.0905	210000 47300	0.40	1.67	2.48	31300 7040	21700 4880	54500 12300	1.44
57.150 2.2500	96.838 3.8125	49.174 1.9360	38.923 1.5324	188000 42200	0.35	1.91	2.84	28000 6280	16900 3810	48700 10900	1.65
57.150 2.2500	96.838 3.8125	76.037 2.9936	65.786 2.5900	188000 42200	0.35	1.91	2.84	28000 6280	16900 3810	48700 10900	1.65
57.150 2.2500	104.775 4.1250	63.094 2.4840	51.979 2.0464	280000 62900	0.34	2.01	3.00	41700 9370	23900 5380	72600 16300	1.74
57.150 2.2500	104.775 4.1250	163.512 6.4375	150.812 5.9375	267000 60000	0.33	2.03	3.02	39700 8930	22600 5090	69200 15600	1.76
57.150 2.2500	112.712 4.4375	69.850 2.2500	57.150 2.2500	242000 54300	0.40	1.68	2.50	36000 8090	24800 5570	62700 14100	1.45
57.150 2.2500	112.712 4.4375	67.602 2.6615	54.902 2.1615	291000 65300	0.34	1.99	2.96	43300 9730	25100 5650	75400 16900	1.72
60.000 2.3622	95.000 3.7402	53.500 2.1060	43.500 1.7122	170000 38200	0.40	1.68	2.50	25300 5690	17400 3910	44000 9900	1.45
64.960 2.5575	149.225 5.8750	285.750 11.2500	266.700 10.5000	716000 161000	0.36	1.86	2.78	107000 24000	66000 14800	186000 41700	1.61
65.000 2.5591	105.000 4.1339	53.515 2.1070	42.515 1.6738	223000 50200	0.45	1.49	2.21	33200 7470	25800 5810	57900 13000	1.29

<sup>(1)</sup>Overall width can vary depending on spacer selection. Contact your Timken engineer for more information.

<sup>(2)</sup>Based on  $1 \times 10^6$  revolutions  $L_{10}$  life, for the ISO life-calculation method.  $C_{1(2)}$  is the double-row radial value.

<sup>(3)</sup>Consult your Timken engineer for instructions on use or review the Timken Engineering Manual on [timken.com/catalogs](http://timken.com/catalogs).

<sup>(4)</sup>Based on  $90 \times 10^6$  revolutions  $L_{10}$  life, for The Timken Company life-calculation method.  $C_{90}$  and  $C_{a90}$  are radial and thrust values for single-row.  $C_{90(2)}$  is the double-row radial value.

Part Number				Dimensions				Bearing Weight
Inner	Outer	Inner Spacer <sup>(5)</sup>	Outer Spacer <sup>(5)</sup>	Shaft		Housing		
				Max. Shaft Fillet Radius	Backing Shoulder Dia.	Max. Housing Fillet Radius	Backing Shoulder Dia.	
				R <sup>(6)</sup>	d <sub>b</sub>	r <sup>(6)</sup>	D <sub>a</sub>	
				mm	mm	mm	mm	kg
				in.	in.	in.	in.	lbs.
529	522	X1S-529	Y1S-522	0.8 0.03	61.0 2.40	0.8 0.03	95.0 3.74	2.61 5.76
HM807046	HM807010	HM807046XA	HM807010EC	3.5 0.14	70.0 2.76	0.8 0.03	100.0 3.94	3.08 6.80
65200	65500	X1S-65200	Y1S-65500	3.5 0.14	75.0 2.95	0.8 0.03	119.0 4.69	6.06 13.37
JLM506849	JLM506810	X4S-385	LM506810ES	1.5 0.06	63.0 2.48	0.5 0.02	86.0 3.39	1.15 2.57
JM207049	JM207010	X4S-385	M207010ES	1.5 0.06	64.0 2.52	0.5 0.02	91.0 3.58	1.75 3.87
JM207049	JM207010	JX5508A	JYH9508P	1.5 0.06	64.0 2.52	0.5 0.02	91.0 3.58	1.81 4.00
JM207049	JM207010	M207049XA	M207010EB	1.5 0.06	64.0 2.52	0.5 0.02	91.0 3.58	2.02 4.46
X32211	Y32211	JX5515A	JYH10011-Q	2.0 0.08	65.0 2.56	0.8 0.03	95.0 3.74	1.87 4.12
387A	382A	X1S-387	Y4S-382A	3.5 0.14	70.0 2.76	0.4 0.02	92.0 3.62	1.29 2.84
387A	382A	X3S-387A		3.5 0.14	70.0 2.76	0.4 0.02	92.0 3.62	1.39 3.06
462	453X	X5S-462		2.3 0.09	67.0 2.64	0.8 0.03	98.0 3.86	2.13 4.68
45289	45221	X1S-45289	Y1S-45221	0.8 0.03	65.0 2.56	0.8 0.03	99.0 3.90	4.60 10.15
3979	3925	X4S-3979	Y1S-3920	3.5 0.14	72.0 2.83	0.5 0.02	106.0 4.17	3.00 6.62
39580	39521	X1S-39580		3.5 0.14	74.0 2.91	0.8 0.03	107.0 4.21	2.85 6.31
JLM508748	JLM508710	LM508748XA	LM508710ES	5.0 0.20	75.0 2.95	0.5 0.02	91.0 3.58	1.27 2.78
6464	6420	X1S-6464	Y4S-6420	3.5 0.14	87.0 3.43	0.8 0.03	140.0 5.51	17.66 38.94
JLM710949C	JLM710910	LM710949XA	LM710910ES	3.0 0.12	78.0 3.07	0.4 0.02	100.5 3.96	1.62 3.53

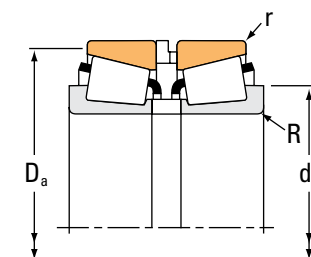
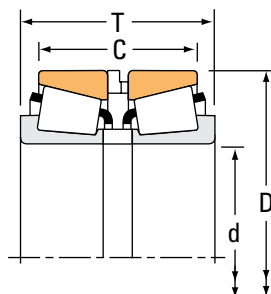
<sup>(5)</sup>Contact your Timken engineer for information on spacer configurations.

<sup>(6)</sup>These maximum fillet radii will be cleared by the bearing corners.

# TAPERED ROLLER BEARINGS

## DOUBLE-ROW • TYPE 2TS-IM

### TYPE 2TS-IM



Bearing Dimensions				Load Ratings							
Bore d	O.D. D	Width <sup>(1)</sup> T	Width C	Dynamic <sup>(2)</sup>				Dynamic <sup>(4)</sup>			
				C <sub>1(2)</sub>	e	Factors <sup>(3)</sup> Y <sub>1</sub>	Y <sub>2</sub>	C <sub>90</sub>	C <sub>a90</sub>	C <sub>90(2)</sub>	Factors <sup>(3)</sup> K
mm in.	mm in.	mm in.	mm in.	N lbf				N lbf	N lbf	N lbf	
65.000 2.5591	105.000 4.1339	72.365 2.8490	61.365 2.4160	223000 50200	0.45	1.49	2.21	33200 7470	25800 5810	57900 13000	1.29
65.000 2.5591	110.000 4.3307	61.491 2.4209	50.488 1.9877	291000 65400	0.40	1.68	2.50	43300 9740	29800 6700	75400 17000	1.45
65.087 2.5625	136.525 5.3750	98.425 3.8750	79.375 3.1250	556000 125000	0.47	1.43	2.12	82700 18600	67000 15100	144000 32400	1.24
65.087 2.5625	136.525 5.3750	193.675 7.6250	174.625 6.8750	556000 125000	0.47	1.43	2.12	82700 18600	67000 15100	144000 32400	1.24
66.675 2.6250	112.712 4.4375	67.945 2.6750	55.245 2.1750	291000 65300	0.34	1.99	2.96	43300 9730	25100 5650	75400 16900	1.72
66.675 2.6250	112.712 4.4375	69.850 2.7500	57.150 2.2500	242000 54300	0.40	1.68	2.50	36000 8090	24800 5570	62700 14100	1.45
66.675 2.6250	122.238 4.8125	102.000 4.0157	85.235 3.3557	465000 104000	0.34	2.00	2.98	69200 15600	40000 8990	121000 27100	1.73
66.675 2.6250	122.238 4.8125	106.147 4.1790	89.383 3.5190	465000 104000	0.34	2.00	2.98	69200 15600	40000 8990	121000 27100	1.73
66.675 2.6250	136.525 5.3750	98.425 3.8750	79.375 3.1250	556000 125000	0.47	1.43	2.12	82700 18600	67000 15100	144000 32400	1.24
66.675 2.6250	177.800 7.0000	127.000 5.0000	87.315 3.4376	785000 176000	0.80	0.85	1.26	117000 26300	160000 35900	203000 45700	0.73
68.262 2.6875	110.000 4.3307	52.253 2.0572	45.903 1.8072	172000 38700	0.40	1.68	2.50	25600 5760	17600 3970	44600 10000	1.45
68.262 2.6875	110.000 4.3307	79.045 3.1120	72.695 2.8620	172000 38700	0.40	1.68	2.50	25600 5760	17600 3970	44600 10000	1.45
68.262 2.6875	152.400 6.0000	105.250 4.1437	73.500 2.8937	589000 132000	0.66	1.03	1.53	87700 19700	98500 22100	153000 34300	0.89
69.850 2.7500	127.000 5.0000	95.250 3.7500	76.200 3.0000	399000 89700	0.50	1.34	2.00	59400 13400	51100 11500	103000 23300	1.16
69.850 2.7500	146.050 5.7500	88.900 3.5000	57.150 2.2500	474000 107000	0.78	0.86	1.28	70700 15900	94700 21300	123000 27700	0.75
69.850 2.7500	146.050 5.7500	90.488 3.5625	58.738 2.3125	474000 107000	0.78	0.86	1.28	70700 15900	94700 21300	123000 27700	0.75
69.850 2.7500	146.050 5.7500	91.516 3.6030	59.766 2.3530	474000 107000	0.78	0.86	1.28	70700 15900	94700 21300	123000 27700	0.75

<sup>(1)</sup>Overall width can vary depending on spacer selection. Contact your Timken engineer for more information.

<sup>(2)</sup>Based on 1 x 10<sup>6</sup> revolutions L<sub>10</sub> life, for the ISO life-calculation method. C<sub>1(2)</sub> is the double-row radial value.

<sup>(3)</sup>Consult your Timken engineer for instructions on use or review the Timken Engineering Manual on [timken.com/catalogs](http://timken.com/catalogs).

<sup>(4)</sup>Based on 90 x 10<sup>6</sup> revolutions L<sub>10</sub> life, for The Timken Company life-calculation method. C<sub>90</sub> and C<sub>a90</sub> are radial and thrust values for single-row. C<sub>90(2)</sub> is the double-row radial value.

Part Number				Dimensions				Bearing Weight
Inner	Outer	Inner Spacer <sup>(5)</sup>	Outer Spacer <sup>(5)</sup>	Shaft		Housing		
				Max. Shaft Fillet Radius R <sup>(6)</sup>	Backing Shoulder Dia. d <sub>b</sub>	Max. Housing Fillet Radius r <sup>(6)</sup>	Backing Shoulder Dia. D <sub>a</sub>	
				mm in.	mm in.	mm in.	mm in.	kg lbs.
JLM710949C	JLM710910	JX6526A	JYH10524-QH	3.0 0.12	78.0 3.07	0.4 0.02	100.5 3.96	1.99 4.36
JM511946	JM511910	M511946XA	M511910ES	3.0 0.12	78.0 3.07	0.8 0.03	105.0 4.13	2.24 4.93
H715340	H715311	H715340XB	H715311EB	3.5 0.14	89.0 3.50	0.6 0.03	132.0 5.20	7.05 15.54
H715340	H715311	H715340XA	H715311EA	3.5 0.14	89.0 3.50	0.6 0.03	132.0 5.20	11.16 24.60
39590	39520	X1S-39590	Y5S-39520	3.5 0.14	82.0 3.23	0.8 0.03	107.0 4.21	2.48 5.47
3984	3920	X1S-3984	Y1S-3920	3.5 0.14	80.0 3.15	0.5 0.02	106.0 4.17	2.51 5.56
HM212049	HM212011	K167207	K167208	3.5 0.14	82.0 3.23	0.8 0.03	116.0 4.57	4.60 10.11
HM212049	HM212011	HM212049XS	HM212011EB	3.5 0.14	82.0 3.23	0.8 0.03	116.0 4.57	4.71 10.36
H715341	H715311	H715341XA	H715311EB	3.5 0.14	91.0 3.58	0.6 0.03	132.0 5.20	6.94 15.30
HH914449	HH914412	HH914449XA	HH914412EB	3.5 0.14	106.0 4.17	1.5 0.06	165.0 6.50	14.31 31.51
399A	394A	X1S-399A		2.3 0.09	78.0 3.07	0.4 0.02	105.0 4.13	1.55 3.41
399A	394A	X7S-399A	Y7S-394A	2.3 0.09	78.0 3.07	0.4 0.02	105.0 4.13	2.58 5.69
9185	9121	X1S-9185	Y6S-9121	3.5 0.14	94.0 3.70	0.8 0.03	145.0 5.71	8.02 17.65
HM813846	HM813811	HM813846XA	HM813811EB	3.5 0.14	89.0 3.50	0.8 0.03	121.0 4.76	4.52 9.95
H913849	H913810	H913849XE	H913810ES	3.5 0.14	95.0 3.74	0.8 0.03	138.0 5.43	6.10 13.47
H913849	H913810	H913849XA	K85372	3.5 0.14	95.0 3.74	0.8 0.03	138.0 5.43	6.09 13.45
H913849	H913810	H913849XC	H913810EE	3.5 0.14	95.0 3.74	0.8 0.03	138.0 5.43	6.15 13.58

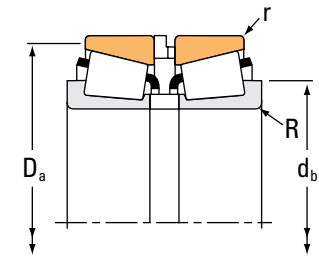
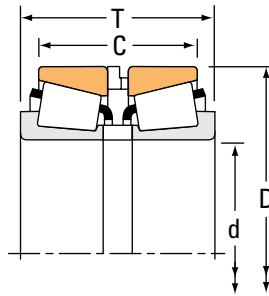
<sup>(5)</sup>Contact your Timken engineer for information on spacer configurations.

<sup>(6)</sup>These maximum fillet radii will be cleared by the bearing corners.

# TAPERED ROLLER BEARINGS

## DOUBLE-ROW • TYPE 2TS-IM

### TYPE 2TS-IM



Bearing Dimensions				Load Ratings							
Bore d	O.D. D	Width <sup>(1)</sup> T	Width C	Dynamic <sup>(2)</sup>				Dynamic <sup>(4)</sup>			
				C <sub>1(2)</sub>	e	Factors <sup>(3)</sup> Y <sub>1</sub>	Y <sub>2</sub>	C <sub>90</sub>	C <sub>a90</sub>	C <sub>90(2)</sub>	Factors <sup>(3)</sup> K
mm in.	mm in.	mm in.	mm in.	N lbf				N lbf	N lbf	N lbf	
70.000 2.7559	110.000 4.3307	56.525 2.2254	44.525 1.7530	232000 52100	0.43	1.55	2.31	34500 7760	25700 5780	60100 13500	1.34
70.000 2.7559	115.000 4.5276	63.505 2.5002	51.507 2.0278	310000 69600	0.43	1.57	2.34	46100 10400	33900 7630	80300 18000	1.36
73.025 2.8750	112.712 4.4375	58.687 2.3105	45.987 1.8105	192000 43300	0.49	1.38	2.06	28600 6440	23900 5370	49900 11200	1.20
73.025 2.8750	117.475 4.6250	95.250 3.7500	82.550 3.2500	241000 54200	0.44	1.55	2.31	35900 8060	26800 6020	62400 14000	1.34
75.000 2.9528	115.000 4.5276	55.270 2.1760	43.270 1.7035	244000 54900	0.46	1.47	2.19	36400 8180	28600 6420	63400 14200	1.27
75.000 2.9528	115.000 4.5276	55.504 2.1852	43.504 1.7126	244000 54900	0.46	1.47	2.19	36400 8180	28600 6420	63400 14200	1.27
75.000 2.9528	115.000 4.5276	75.000 2.9528	63.000 2.4802	244000 54900	0.46	1.47	2.19	36400 8180	28600 6420	63400 14200	1.27
76.200 3.0000	161.925 6.3750	107.950 4.2500	73.025 2.8750	614000 138000	0.71	0.95	1.42	91400 20600	111000 24900	159000 35800	0.82
76.200 3.0000	161.925 6.3750	115.888 4.5625	93.662 3.6875	765000 172000	0.40	1.69	2.51	114000 25600	78100 17600	198000 44600	1.46
76.200 3.0000	171.450 6.7500	112.712 4.4375	77.788 3.0625	632000 142000	0.76	0.88	1.31	94100 21200	123000 27700	164000 36800	0.76
76.200 3.0000	171.450 6.7500	113.424 4.4655	78.500 3.0906	632000 142000	0.76	0.88	1.31	94100 21200	123000 27700	164000 36800	0.76
76.200 3.0000	180.975 7.1250	114.300 4.5000	77.790 3.0626	781000 175000	0.73	0.92	1.37	116000 26100	146000 32700	202000 45500	0.80
79.375 3.1250	190.500 7.5000	127.000 5.0000	104.775 4.1250	929000 209000	0.33	2.02	3.00	138000 31100	79300 17800	241000 54200	1.74
80.000 3.1496	130.000 5.1181	77.456 3.0495	64.452 2.5375	410000 92100	0.39	1.74	2.59	61000 13700	40600 9120	106000 23900	1.50
80.000 3.1496	140.000 5.5118	64.000 2.5196	51.500 2.0276	296000 66500	0.42	1.61	2.39	44000 9900	31700 7120	76700 17200	1.39
80.000 3.1496	140.000 5.5118	104.000 4.0945	82.000 3.2283	517000 116000	0.43	1.59	2.36	76900 17300	56000 12600	134000 30100	1.37
83.345 3.2813	125.412 4.9375	98.425 3.8750	87.315 3.4376	204000 45900	0.42	1.62	2.42	30400 6830	21600 4860	52900 11900	1.40

<sup>(1)</sup>Overall width can vary depending on spacer selection. Contact your Timken engineer for more information.

<sup>(2)</sup>Based on 1 x 10<sup>6</sup> revolutions L<sub>10</sub> life, for the ISO life-calculation method. C<sub>1(2)</sub> is the double-row radial value.

<sup>(3)</sup>Consult your Timken engineer for instructions on use or review the Timken Engineering Manual on [timken.com/catalogs](http://timken.com/catalogs).

<sup>(4)</sup>Based on 90 x 10<sup>6</sup> revolutions L<sub>10</sub> life, for The Timken Company life-calculation method. C<sub>90</sub> and C<sub>a90</sub> are radial and thrust values for single-row.

C<sub>90(2)</sub> is the double-row radial value.



Part Number				Dimensions				Bearing Weight
Inner	Outer	Inner Spacer <sup>(5)</sup>	Outer Spacer <sup>(5)</sup>	Shaft		Housing		
				Max. Shaft Fillet Radius	Backing Shoulder Dia.	Max. Housing Fillet Radius	Backing Shoulder Dia.	
				R <sup>(6)</sup>	d <sub>b</sub>	r <sup>(6)</sup>	D <sub>a</sub>	
				mm in.	mm in.	mm in.	mm in.	kg lbs.
X32014X	Y32014X	JX7006A	JYH11007TSR	1.5 0.06	78.0 3.07	0.5 0.02	105.0 4.13	1.85 4.11
JM612949	JM612910	M612949XA	M612910ES	3.0 0.12	83.0 3.27	0.6 0.03	110.0 4.33	2.36 5.23
29685	29620	X2S-29685	Y7S-29620	3.5 0.14	86.0 3.39	0.6 0.03	109.0 4.29	1.94 4.28
33287	33462	X4S-33287	Y6S-33462	3.5 0.14	88.0 3.46	0.8 0.03	112.0 4.41	3.38 7.43
JLM714149	JLM714110		XC14638-SC	3.0 0.12	88.0 3.46	0.5 0.02	110.5 4.35	1.80 3.94
JLM714149	JLM714110	LM714149XB	LM714110ES	3.0 0.12	88.0 3.46	0.5 0.02	110.5 4.35	1.88 4.12
JLM714149	JLM714110	LM714149XA	LM714110EA	3.0 0.12	88.0 3.46	0.5 0.02	110.5 4.35	2.26 4.98
9285	9220	X2S-9285	Y3S-9220	3.5 0.14	111.0 4.37	0.8 0.03	153.0 6.03	8.93 19.72
6575	6535	X1S-6575	Y1S-6535	6.4 0.25	104.0 4.09	0.8 0.03	154.0 6.06	11.20 24.68
9380	9321	X5S-9380	Y6S-9321	3.5 0.14	105.0 4.13	0.8 0.03	164.0 6.46	11.34 24.99
9380	9321	X1H9380		3.5 0.14	105.0 4.13	0.8 0.03	164.0 6.46	10.69 23.56
H917840	H917810	H917840XA	H917810EA	3.5 0.14	110.0 4.33	1.5 0.06	170.0 6.69	13.84 30.53
HH221431	HH221410	HH221431XA	HH221410EE	3.5 0.14	103.0 4.06	0.8 0.03	179.0 7.05	17.64 38.91
JM515649	JM515610	M515649XC	M515610ES	3.0 0.12	94.0 3.70	0.6 0.03	125.0 4.92	3.62 8.00
X30216M	Y30216M	K163675	K163676	2.5 0.10	94.0 3.70	1.0 0.04	133.0 5.24	3.57 7.86
X33216	Y33216	K161554	JYH14099R	2.5 0.10	97.0 3.82	0.5 0.02	135.0 5.31	6.30 13.88
27689	27620	X3S-27689	Y5S-27620	0.8 0.03	90.0 3.54	0.8 0.03	120.0 4.72	3.27 7.20

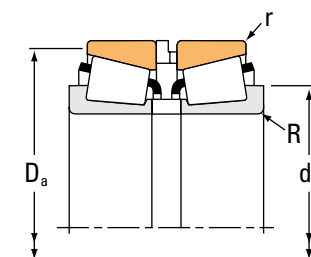
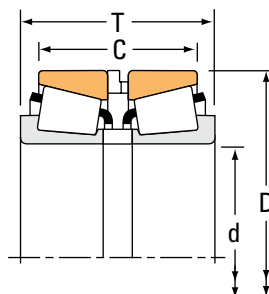
<sup>(5)</sup>Contact your Timken engineer for information on spacer configurations.

<sup>(6)</sup>These maximum fillet radii will be cleared by the bearing corners.

# TAPERED ROLLER BEARINGS

## DOUBLE-ROW • TYPE 2TS-IM

### TYPE 2TS-IM



Bearing Dimensions				Load Ratings							
Bore d	O.D. D	Width <sup>(1)</sup> T	Width C	Dynamic <sup>(2)</sup>		Factors <sup>(3)</sup>		Dynamic <sup>(4)</sup>			Factors <sup>(3)</sup>
mm in.	mm in.	mm in.	mm in.	C <sub>1(2)</sub>	e	Y <sub>1</sub>	Y <sub>2</sub>	C <sub>90</sub>	C <sub>a90</sub>	C <sub>90(2)</sub>	K
N lbf	N lbf	N lbf	N lbf	N lbf	N lbf	N lbf	N lbf	N lbf	N lbf	N lbf	N lbf
85.000 3.3465	130.000 5.1181	65.491 2.5784	53.491 2.1060	281000 63100	0.44	1.52	2.26	41800 9400	31800 7150	72800 16400	1.31
85.000 3.3465	140.000 5.5118	85.470 3.3649	70.470 2.7744	490000 110000	0.41	1.66	2.47	73000 16400	50900 11400	127000 28600	1.43
85.000 3.3465	188.912 7.4375	112.944 4.4466	69.850 2.7500	667000 150000	0.87	0.78	1.16	99300 22300	147000 33100	173000 38900	0.67
85.725 3.3750	168.275 6.6250	184.125 7.2490	161.925 6.3750	461000 104000	0.47	1.43	2.14	68600 15400	55300 12400	119000 26900	1.24
88.900 3.5000	168.275 6.6250	122.212 4.8115	96.812 3.8115	844000 190000	0.30	2.26	3.36	126000 28300	64400 14500	219000 49200	1.95
89.975 3.5423	146.975 5.7864	127.000 5.0000	112.000 4.4094	565000 127000	0.33	2.03	3.02	84200 18900	47900 10800	147000 33000	1.76
90.000 3.5433	145.000 5.7087	78.491 3.0902	62.489 2.4602	387000 87000	0.44	1.52	2.26	57700 13000	43900 9860	100000 22600	1.31
90.000 3.5433	155.000 6.1024	97.314 3.8313	80.314 3.1619	683000 153000	0.34	1.98	2.95	102000 22900	59400 13300	177000 39800	1.71
90.000 3.5433	155.000 6.1024	127.000 5.0000	110.000 4.3306	683000 153000	0.34	1.98	2.95	102000 22900	59400 13300	177000 39800	1.71
95.250 3.7500	146.050 5.7500	80.975 3.1880	66.690 2.6256	343000 77100	0.45	1.51	2.24	51100 11500	39200 8810	88900 20000	1.30
95.250 3.7500	148.430 5.8437	66.675 2.6250	52.390 2.0626	336000 75600	0.49	1.37	2.04	50100 11300	42200 9480	87100 19600	1.19
95.250 3.7500	152.400 6.0000	79.375 3.1250	60.325 2.3750	376000 84600	0.44	1.53	2.27	56000 12600	42400 9530	97500 21900	1.32
95.250 3.7500	168.275 6.6250	212.725 8.3750	190.500 7.5000	461000 104000	0.47	1.43	2.14	68600 15400	55300 12400	119000 26900	1.24
96.838 3.8125	188.912 7.4375	107.950 4.2500	69.850 2.7500	667000 150000	0.87	0.78	1.16	99300 22300	147000 33100	173000 38900	0.67
96.838 3.8125	188.912 7.4375	114.300 4.5000	76.200 3.0000	667000 150000	0.87	0.78	1.16	99300 22300	147000 33100	173000 38900	0.67
99.975 3.9360	212.725 8.3750	142.875 5.6250	117.475 4.6250	1180000 266000	0.33	2.07	3.09	176000 39600	98300 22100	307000 69000	1.79
100.000 3.9370	155.000 6.1024	79.416 3.1266	63.419 2.4968	403000 90600	0.47	1.43	2.12	60000 13500	48600 10900	104000 23500	1.24

<sup>(1)</sup>Overall width can vary depending on spacer selection. Contact your Timken engineer for more information.

<sup>(2)</sup>Based on  $1 \times 10^6$  revolutions  $L_{10}$  life, for the ISO life-calculation method.  $C_{1(2)}$  is the double-row radial value.

<sup>(3)</sup>Consult your Timken engineer for instructions on use or review the Timken Engineering Manual on [timken.com/catalogs](http://timken.com/catalogs).

<sup>(4)</sup>Based on  $90 \times 10^6$  revolutions  $L_{10}$  life, for The Timken Company life-calculation method.  $C_{90}$  and  $C_{a90}$  are radial and thrust values for single-row.  $C_{90(2)}$  is the double-row radial value.

Part Number				Dimensions				Bearing Weight
Inner	Outer	Inner Spacer <sup>(5)</sup>	Outer Spacer <sup>(5)</sup>	Shaft		Housing		
				Max. Shaft Fillet Radius R <sup>(6)</sup>	Backing Shoulder Dia. d <sub>b</sub>	Max. Housing Fillet Radius r <sup>(6)</sup>	Backing Shoulder Dia. D <sub>a</sub>	
				mm in.	mm in.	mm in.	mm in.	kg lbs.
JM716649	JM716610	M716649XB	M716610ES	3.0 0.12	98.0 3.86	0.8 0.03	125.0 4.92	2.88 6.36
JHM516849	JHM516810	JX8599AI	HM516810ES	3.0 0.12	100.0 3.94	1.0 0.04	134.0 5.28	4.75 10.48
90334	90744	X1S-90334	Y4S-90744	3.5 0.14	116.0 4.57	1.5 0.06	179.0 7.06	13.59 29.94
677	672	X2S-677	Y5S-672	3.5 0.14	105.0 4.13	0.8 0.03	160.0 6.30	14.07 31.00
850	832	X4S-850	Y3S-832	3.5 0.14	106.0 4.17	0.8 0.03	155.0 6.10	10.64 23.43
HM218248	HM218210	HM218248XA	HM218210EB	7.0 0.28	112.0 4.41	0.8 0.03	141.0 5.55	5.60 12.33
JM718149	JM718110	M718149XA	M718110ES	3.0 0.12	106.0 4.17	1.0 0.04	138.8 5.46	4.59 10.12
JHM318448	JHM318410	HM318448XA	HM318410ES	3.0 0.12	106.0 4.17	0.8 0.03	148.0 5.83	6.97 15.33
JHM318448	JHM318410	JX9039A	JYH15539RSR	3.0 0.12	106.0 4.17	0.8 0.03	148.0 5.83	8.36 18.39
47896	47820	X2S-47896	Y3S-47820	3.5 0.14	110.0 4.33	0.8 0.03	140.0 5.51	4.38 9.65
42375	42584	X1S-42375	Y6S-42584	3.0 0.12	108.0 4.25	0.8 0.03	142.0 5.59	3.79 8.36
594	592A	X4S-594		3.5 0.14	110.0 4.33	0.8 0.03	144.0 5.67	5.03 11.09
683	672	X3S-683	Y7S-672	3.5 0.14	113.0 4.45	0.8 0.03	160.0 6.30	14.10 31.08
90381	90744	X4S-90381	Y4S-90744	3.5 0.14	125.0 4.92	1.5 0.06	179.0 7.06	11.64 25.65
90381	90744	X1S-90381	Y1S-90744	3.5 0.14	125.0 4.92	1.5 0.06	179.0 7.06	12.09 26.64
HH224334	HH224310	HH224334XA		3.5 0.14	124.0 4.88	0.8 0.03	201.7 7.94	22.81 50.28
JM720249	JM720210	M720249XA	M720210ES	3.0 0.12	115.0 4.53	0.8 0.03	149.0 5.87	5.01 11.03

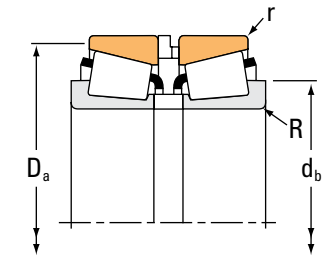
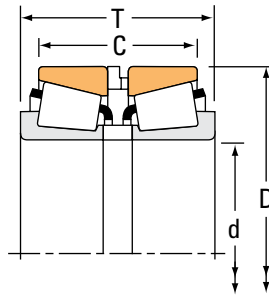
<sup>(5)</sup>Contact your Timken engineer for information on spacer configurations.

<sup>(6)</sup>These maximum fillet radii will be cleared by the bearing corners.

# TAPERED ROLLER BEARINGS

## DOUBLE-ROW • TYPE 2TS-IM

### TYPE 2TS-IM



Bearing Dimensions				Load Ratings							
Bore d	O.D. D	Width <sup>(1)</sup> T	Width C	Dynamic <sup>(2)</sup>		Factors <sup>(3)</sup>		Dynamic <sup>(4)</sup>			Factors <sup>(3)</sup>
mm in.	mm in.	mm in.	mm in.	C <sub>1(2)</sub>	e	Y <sub>1</sub>	Y <sub>2</sub>	C <sub>90</sub>	C <sub>a90</sub>	C <sub>90(2)</sub>	K
N lbf	N lbf	N lbf	N lbf	N lbf	N lbf	N lbf	N lbf	N lbf	N lbf	N lbf	N lbf
100.000 3.9370	160.000 6.2992	89.416 3.5203	71.412 2.8115	576000 130000	0.47	1.43	2.14	85800 19300	69100 15500	149000 33600	1.24
100.000 3.9370	180.000 7.0866	86.500 3.4055	70.500 2.7756	524000 118000	0.42	1.61	2.39	78000 17500	56100 12600	136000 30500	1.39
101.600 4.0000	168.275 6.6250	83.718 7.2330	161.493 6.3580	461000 104000	0.47	1.43	2.14	68600 15400	55300 12400	119000 26900	1.24
101.600 4.0000	190.500 7.5000	153.416 6.0400	128.016 5.0400	797000 179000	0.33	2.02	3.00	119000 26700	68000 15300	207000 46400	1.74
101.600 4.0000	190.500 7.5000	157.836 6.2140	132.436 5.2140	797000 179000	0.33	2.02	3.00	119000 26700	68000 15300	207000 46400	1.74
101.600 4.0000	190.500 7.5000	189.586 7.4640	167.361 6.5890	929000 209000	0.33	2.02	3.00	138000 31100	79300 17800	241000 54200	1.74
101.600 4.0000	250.825 9.8750	161.925 6.3750	111.125 4.3750	1440000 324000	0.70	0.97	1.44	215000 48200	257000 57800	374000 84000	0.84
101.600 4.0000	250.825 9.8750	165.100 6.5000	114.300 4.5000	1440000 324000	0.70	0.97	1.44	215000 48200	257000 57800	374000 84000	0.84
101.600 4.0000	250.825 9.8750	204.521 8.0520	153.721 6.0520	1440000 324000	0.70	0.97	1.44	215000 48200	257000 57800	374000 84000	0.84
107.950 4.2500	142.083 5.5938	41.935 1.6510	34.001 1.3386	123000 27500	0.39	1.72	2.57	18200 4100	12200 2750	31800 7140	1.49
107.950 4.2500	158.750 6.2500	50.002 1.9686	35.712 1.4060	238000 53400	0.61	1.11	1.66	35400 7960	36700 8250	61600 13900	0.96
107.950 4.2500	161.925 6.3750	82.550 3.2500	66.675 2.6250	334000 75200	0.51	1.34	1.99	49800 11200	43100 9680	86700 19500	1.16
109.987 4.3302	159.987 6.2987	74.612 2.9375	58.738 2.3125	341000 76600	0.40	1.68	2.50	50700 11400	34900 7850	88400 19900	1.45
110.000 4.3307	165.000 6.4961	79.413 3.1266	62.413 2.4572	396000 88900	0.50	1.36	2.02	58900 13200	50100 11300	103000 23100	1.18
110.000 4.3307	180.000 7.0866	102.365 4.0301	84.365 3.3215	647000 145000	0.41	1.66	2.48	96300 21600	66900 15000	168000 37700	1.44
110.000 4.3307	180.000 7.0866	102.365 4.0301	84.365 3.3215	766000 172000	0.41	1.66	2.48	114000 25700	79200 17800	199000 44700	1.44
114.300 4.5000	152.400 6.0000	47.625 1.8750	38.100 1.5000	206000 46300	0.41	1.63	2.43	30600 6890	21700 4870	53400 12000	1.41

<sup>(1)</sup>Overall width can vary depending on spacer selection. Contact your Timken engineer for more information.

<sup>(2)</sup>Based on  $1 \times 10^6$  revolutions  $L_{10}$  life, for the ISO life-calculation method.  $C_{1(2)}$  is the double-row radial value.

<sup>(3)</sup>Consult your Timken engineer for instructions on use or review the Timken Engineering Manual on [timken.com/catalogs](http://timken.com/catalogs).

<sup>(4)</sup>Based on  $90 \times 10^6$  revolutions  $L_{10}$  life, for The Timken Company life-calculation method.  $C_{90}$  and  $C_{a90}$  are radial and thrust values for single-row.

$C_{90(2)}$  is the double-row radial value.

Part Number				Dimensions				Bearing Weight
Inner	Outer	Inner Spacer <sup>(5)</sup>	Outer Spacer <sup>(5)</sup>	Shaft		Housing		
				Max. Shaft Fillet Radius	Backing Shoulder Dia.	Max. Housing Fillet Radius	Backing Shoulder Dia.	
				R <sup>(6)</sup>	d <sub>b</sub>	r <sup>(6)</sup>	D <sub>a</sub>	
				mm in.	mm in.	mm in.	mm in.	kg lbs.
JHM720249	JHM720210	M720249XB	HM720210ES	3.0 0.12	117.0 4.61	0.8 0.03	153.9 6.06	6.28 13.83
X30220M	Y30220M	K161564	K161563	3.0 0.12	119.0 4.69	1.0 0.04	169.0 6.65	8.21 18.10
687	672	X2S-687	Y5S-672	3.5 0.14	118.0 4.65	0.8 0.03	160.0 6.30	12.46 27.46
861	854	X8S-861	Y12S-854	8.0 0.31	129.0 5.08	0.8 0.03	174.0 6.85	16.58 36.55
861	854	X9S-861	Y14S-854	8.0 0.31	129.0 5.08	0.8 0.03	174.0 6.85	17.05 37.58
HH221449	HH221410	HH221449XS	HH221410ER	8.0 0.31	131.0 5.16	0.8 0.03	179.0 7.05	18.79 41.47
HH923649	HH923610	K84216	K84217	6.4 0.25	149.0 5.87	1.5 0.06	228.8 9.01	35.84 79.03
HH923649	HH923610	HH923649XA	K84215	6.4 0.25	149.0 5.87	1.5 0.06	228.8 9.01	35.93 79.22
HH923649	HH923610	HH923649XC	HH923610ES	6.4 0.25	149.0 5.87	1.5 0.06	228.8 9.01	41.48 91.46
LL521849C	LL521811	LL521849XB	LL521811EA	1.5 0.06	115.0 4.53	0.8 0.03	137.0 5.39	1.48 3.27
37425	37625	X6S-37425		3.5 0.14	122.0 4.80	0.8 0.03	152.0 5.98	2.85 6.26
48190	48120	X3S-48190		3.5 0.14	122.0 4.80	0.8 0.03	156.0 6.14	4.81 10.63
LM522548	LM522510	LM522549XA		8.0 0.31	133.0 5.24	0.8 0.03	154.0 6.06	4.40 9.69
JM822049	JM822010	M822049XA	M822010ES	3.0 0.12	125.0 4.92	0.8 0.03	159.0 6.26	5.30 11.73
JHM522649	JHM522610	HM522649XA	HM522610ES	3.0 0.12	127.0 5.00	0.8 0.03	172.0 6.77	9.41 20.70
JHM522649AC	JHM522610	HM522649XA	HM522610ES	7.0 0.28	138.0 5.43	0.8 0.03	172.0 6.77	9.37 20.62
L623149	L623110	L623149XB	L623110EA	1.5 0.06	123.0 4.84	0.8 0.03	147.0 5.79	2.22 4.90

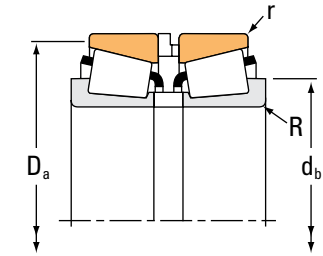
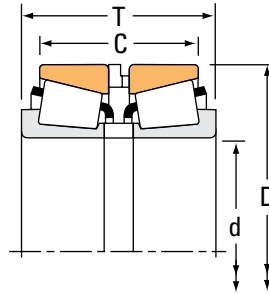
<sup>(5)</sup>Contact your Timken engineer for information on spacer configurations.

<sup>(6)</sup>These maximum fillet radii will be cleared by the bearing corners.

# TAPERED ROLLER BEARINGS

## DOUBLE-ROW • TYPE 2TS-IM

### TYPE 2TS-IM



Bearing Dimensions				Load Ratings							
Bore d	O.D. D	Width <sup>(1)</sup> T	Width C	Dynamic <sup>(2)</sup>		Factors <sup>(3)</sup>		Dynamic <sup>(4)</sup>			Factors <sup>(3)</sup>
				C <sub>1(2)</sub>	e	Y <sub>1</sub>	Y <sub>2</sub>	C <sub>90</sub>	C <sub>a90</sub>	C <sub>90(2)</sub>	K
mm in.	mm in.	mm in.	mm in.	N lbf				N lbf	N lbf	N lbf	
114.300 4.5000	177.800 7.0000	92.075 3.6250	69.850 2.7500	478000 108000	0.52	1.31	1.95	71200 16000	62900 14100	124000 27900	1.13
114.300 4.5000	212.725 8.3750	142.875 5.6250	117.475 4.6250	996000 224000	0.33	2.07	3.09	148000 33300	82700 18600	258000 58000	1.79
114.300 4.5000	212.725 8.3750	150.350 5.9193	124.950 4.9193	1180000 266000	0.33	2.07	3.09	176000 39600	98300 22100	307000 69000	1.79
114.300 4.5000	212.725 8.3750	152.400 6.0000	127.000 5.0000	996000 224000	0.33	2.07	3.09	148000 33300	82700 18600	258000 58000	1.79
114.300 4.5000	228.600 9.0000	212.725 8.3750	180.975 7.1250	1020000 230000	0.74	0.92	1.36	152000 34200	192000 43100	265000 59500	0.79
114.300 4.5000	273.050 10.7500	269.875 10.6250	212.725 8.3750	1850000 417000	0.63	1.07	1.59	276000 62100	299000 67200	481000 108000	0.92
114.300 4.5000	279.400 11.0000	184.150 7.2500	127.000 5.0000	1850000 417000	0.63	1.07	1.59	276000 62100	299000 67200	481000 108000	0.92
115.087 4.5310	190.500 7.5000	106.350 4.1870	80.950 3.1870	633000 142000	0.42	1.62	2.42	94300 21200	67100 15100	164000 36900	1.40
120.000 4.7244	170.000 6.6929	60.250 2.3720	45.250 1.7815	341000 76700	0.47	1.43	2.12	50800 11400	41100 9250	88500 19900	1.24
120.000 4.7244	215.000 8.4646	99.000 3.8976	80.000 3.1496	690000 155000	0.44	1.55	2.31	103000 23100	76500 17200	179000 40200	1.34
120.000 4.7244	215.000 8.4646	146.000 5.7480	123.000 4.8425	1020000 229000	0.44	1.55	2.31	152000 34100	113000 25400	264000 59400	1.34
120.650 4.7500	160.338 6.3125	52.291 2.0587	42.766 1.6837	170000 38200	0.43	1.55	2.31	25300 5680	18800 4230	44000 9890	1.34
120.650 4.7500	234.950 9.2500	157.734 6.2100	129.159 5.0850	1090000 246000	0.37	1.83	2.72	163000 36700	103000 23200	284000 63800	1.58
120.650 4.7500	273.050 10.7500	177.800 7.0000	120.650 4.7500	1850000 417000	0.63	1.07	1.59	276000 62100	299000 67200	481000 108000	0.92
125.298 4.9330	228.600 9.0000	115.888 4.5625	84.138 3.3125	1020000 230000	0.74	0.92	1.36	152000 34200	192000 43100	265000 59500	0.79
127.000 5.0000	182.562 7.1875	85.725 3.3750	73.025 2.8750	466000 105000	0.31	2.21	3.29	69400 15600	36300 8160	121000 27200	1.91
127.000 5.0000	196.850 7.7500	101.600 4.0000	85.725 3.3750	640000 144000	0.34	1.96	2.92	95300 21400	56100 12600	166000 37300	1.70

<sup>(1)</sup>Overall width can vary depending on spacer selection. Contact your Timken engineer for more information.

<sup>(2)</sup>Based on  $1 \times 10^6$  revolutions  $L_{10}$  life, for the ISO life-calculation method.  $C_{1(2)}$  is the double-row radial value.

<sup>(3)</sup>Consult your Timken engineer for instructions on use or review the Timken Engineering Manual on [timken.com/catalogs](http://timken.com/catalogs).

<sup>(4)</sup>Based on  $90 \times 10^6$  revolutions  $L_{10}$  life, for The Timken Company life-calculation method.  $C_{90}$  and  $C_{a90}$  are radial and thrust values for single-row.

$C_{90(2)}$  is the double-row radial value.

Part Number				Dimensions				Bearing Weight
Inner	Outer	Inner Spacer <sup>(5)</sup>	Outer Spacer <sup>(5)</sup>	Shaft		Housing		
				Max. Shaft Fillet Radius R <sup>(6)</sup>	Backing Shoulder Dia. d <sub>b</sub>	Max. Housing Fillet Radius r <sup>(6)</sup>	Backing Shoulder Dia. D <sub>a</sub>	
				mm in.	mm in.	mm in.	mm in.	kg lbs.
64450	64700	X1S-64450	Y8S-64700	3.5 0.14	131.0 5.16	0.8 0.03	172.0 6.77	7.39 16.32
938	932	X9S-938	Y14S-932	7.0 0.28	141.0 5.55	0.8 0.03	193.1 7.60	20.30 44.77
HH224346	HH224310	HH224346XC	HH224310EX	7.0 0.28	143.0 5.63	0.8 0.03	201.7 7.94	20.74 45.71
938	932	X7S-938	Y10S-932	7.0 0.28	141.0 5.55	0.8 0.03	193.1 7.60	21.29 46.97
HM926740	HM926710	HM926740XE	HM926710ER	3.5 0.14	146.0 5.75	0.8 0.03	219.3 8.63	32.84 72.41
HH926744	HH926710	HH926744XE	HH926710EX	6.4 0.25	164.0 6.46	1.5 0.06	253.3 9.97	63.58 140.13
HH926744	HH926716	HH926744XB	HH926716EB	6.4 0.25	164.0 6.46	1.5 0.06	253.3 9.97	48.94 107.87
71453	71750	X2S-71453		3.5 0.14	133.0 5.24	0.8 0.03	181.0 7.13	10.30 22.72
JP12049	JP12010		JYH17006R	3.0 0.12	133.0 5.24	0.8 0.03	164.5 6.48	3.54 7.85
X30224M	Y30224M	K161562	K161561	3.0 0.12	140.0 5.51	1.0 0.04	201.0 7.91	13.52 29.79
X32224M	Y32224M	JX12030AM	JY21523RM	3.0 0.12	147.0 5.79	1.0 0.04	204.5 8.05	20.52 45.23
L624549	L624510	L624549XS	L624510EE	1.5 0.06	129.0 5.08	0.8 0.03	155.0 6.10	2.66 5.84
95475	95925	X4S-95475		6.4 0.25	149.0 5.87	1.5 0.06	217.0 8.54	25.92 57.19
HH926749	HH926710	HH926749XA	HH926710EA	6.4 0.25	168.0 6.61	1.5 0.06	253.3 9.97	44.65 98.40
HM926745	HM926710	HM926745XA	HM926710EB	3.5 0.14	154.0 6.06	0.8 0.03	219.3 8.63	18.45 40.67
48290	48220	X1S-48290	Y7S-48220	3.5 0.14	141.0 5.55	0.8 0.03	176.0 6.93	6.89 15.21
67388	67322	X1S-67388	Y2S-67322	3.5 0.14	144.0 5.67	1.5 0.06	189.0 7.44	10.69 23.59

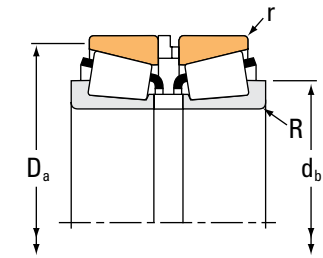
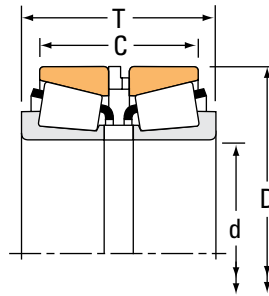
<sup>(5)</sup>Contact your Timken engineer for information on spacer configurations.

<sup>(6)</sup>These maximum fillet radii will be cleared by the bearing corners.

# TAPERED ROLLER BEARINGS

## DOUBLE-ROW • TYPE 2TS-IM

### TYPE 2TS-IM



Bearing Dimensions				Load Ratings							
Bore d	O.D. D	Width <sup>(1)</sup> T	Width C	Dynamic <sup>(2)</sup>		Factors <sup>(3)</sup>		Dynamic <sup>(4)</sup>			Factors <sup>(3)</sup>
mm in.	mm in.	mm in.	mm in.	C <sub>1(2)</sub>	e	Y <sub>1</sub>	Y <sub>2</sub>	C <sub>90</sub>	C <sub>a90</sub>	C <sub>90(2)</sub>	K
N lbf	N lbf	N lbf	N lbf								
127.000 5.0000	228.600 9.0000	158.750 6.2500	127.000 5.0000	1020000 230000	0.74	0.92	1.36	152000 34200	192000 43100	265000 59500	0.79
127.000 5.0000	304.800 12.0000	190.500 7.5000	127.000 5.0000	2020000 453000	0.73	0.93	1.38	300000 67500	374000 84100	522000 117000	0.80
127.792 5.0312	228.600 9.0000	115.888 4.5625	84.138 3.3125	1020000 230000	0.74	0.92	1.36	152000 34200	192000 43100	265000 59500	0.79
129.967 5.1168	219.975 8.6604	180.300 7.0984	154.900 6.0984	797000 179000	0.32	2.12	3.15	119000 26700	64800 14600	207000 46500	1.83
130.000 5.1181	185.000 7.2835	69.000 2.7165	53.000 2.0866	341000 76700	0.47	1.43	2.12	50800 11400	41100 9250	88400 19900	1.24
130.000 5.1181	230.000 9.0551	149.500 5.8858	122.000 4.8031	1190000 267000	0.44	1.55	2.31	177000 39800	132000 29600	308000 69200	1.34
133.350 5.2500	215.900 8.5000	222.250 8.7500	196.850 7.7500	665000 150000	0.49	1.38	2.06	99000 22300	82600 18600	172000 38800	1.20
133.350 5.2500	234.950 9.2500	138.500 5.4528	109.926 4.3278	1090000 246000	0.37	1.83	2.72	163000 36700	103000 23200	284000 63800	1.58
136.525 5.3750	190.500 7.5000	88.694 3.4919	75.994 2.9919	492000 111000	0.32	2.10	3.13	73300 16500	40300 9060	128000 28700	1.82
139.700 5.5000	215.900 8.5000	101.600 4.0000	76.200 3.0000	665000 150000	0.49	1.38	2.06	99000 22300	82600 18600	172000 38800	1.20
139.700 5.5000	228.600 9.0000	123.825 4.8750	98.425 3.8750	906000 204000	0.42	1.60	2.39	135000 30300	97200 21800	235000 52800	1.39
139.700 5.5000	295.275 11.6250	238.125 9.3750	187.325 7.3750	1990000 447000	0.32	2.12	3.15	296000 66600	162000 36300	516000 116000	1.83
139.700 5.5000	304.800 12.0000	212.725 8.3750	174.625 6.8750	1350000 303000	0.33	2.03	3.02	201000 45200	114000 25700	350000 78700	1.76
139.700 5.5000	307.975 12.1250	298.450 11.7500	254.000 10.0000	2010000 451000	0.33	2.07	3.08	299000 67200	167000 37500	520000 117000	1.79
140.000 5.5118	210.000 8.2677	98.000 3.8583	76.000 2.9921	685000 154000	0.46	1.47	2.19	102000 22900	80000 18000	177000 39900	1.27
146.050 5.7500	203.200 8.0000	88.900 3.5000	77.790 3.0626	342000 76900	0.37	1.83	2.73	50900 11400	32100 7220	88600 19900	1.59
146.050 5.7500	268.288 10.5625	164.225 6.4656	129.300 5.0910	1620000 364000	0.39	1.74	2.59	241000 54200	160000 35900	420000 94300	1.51

<sup>(1)</sup>Overall width can vary depending on spacer selection. Contact your Timken engineer for more information.

<sup>(2)</sup>Based on  $1 \times 10^6$  revolutions  $L_{10}$  life, for the ISO life-calculation method.  $C_{1(2)}$  is the double-row radial value.

<sup>(3)</sup>Consult your Timken engineer for instructions on use or review the Timken Engineering Manual on [timken.com/catalogs](http://timken.com/catalogs).

<sup>(4)</sup>Based on  $90 \times 10^6$  revolutions  $L_{10}$  life, for The Timken Company life-calculation method.  $C_{90}$  and  $C_{a90}$  are radial and thrust values for single-row.

$C_{90(2)}$  is the double-row radial value.



Part Number				Dimensions				Bearing Weight
Inner	Outer	Inner Spacer <sup>(5)</sup>	Outer Spacer <sup>(5)</sup>	Shaft		Housing		
				Max. Shaft Fillet Radius	Backing Shoulder Dia.	Max. Housing Fillet Radius	Backing Shoulder Dia.	
				R <sup>(6)</sup>	d <sub>b</sub>	r <sup>(6)</sup>	D <sub>a</sub>	
				mm in.	mm in.	mm in.	mm in.	kg lbs.
HM926747	HM926710	HM926747XE		<b>3.5</b> 0.14	<b>156.0</b> 6.14	<b>0.8</b> 0.03	<b>219.3</b> 8.63	<b>19.05</b> 42.03
HH932132	HH932110	HH932132XA	HH932110EA	<b>6.4</b> 0.25	<b>182.0</b> 7.17	<b>1.5</b> 0.06	<b>288.0</b> 11.34	<b>63.69</b> 140.42
HM926749	HM926710	HM926749XE	HM926710EB	<b>3.5</b> 0.14	<b>156.0</b> 6.14	<b>0.8</b> 0.03	<b>219.3</b> 8.63	<b>18.15</b> 40.05
HM227545	HM227519	HM227545XB	HM227519EE	<b>3.3</b> 0.13	<b>147.0</b> 5.79	<b>1.5</b> 0.06	<b>202.0</b> 7.95	<b>21.67</b> 47.75
JP13049	JP13010	K160157	K160158	<b>3.0</b> 0.12	<b>143.0</b> 5.63	<b>0.8</b> 0.03	<b>179.0</b> 7.05	<b>4.76</b> 10.49
X32226M	Y32226M	K161556	K161555	<b>4.0</b> 0.16	<b>161.0</b> 6.34	<b>1.0</b> 0.04	<b>219.0</b> 8.62	<b>24.07</b> 53.10
74525	74850	X3S-74525	Y6S-74850	<b>3.5</b> 0.14	<b>152.0</b> 5.98	<b>0.8</b> 0.03	<b>208.0</b> 8.19	<b>24.63</b> 54.26
95525	95925	K160046	K160047	<b>9.7</b> 0.38	<b>166.0</b> 6.54	<b>1.5</b> 0.06	<b>217.0</b> 8.54	<b>23.24</b> 51.25
48393	48320	X6S-48393		<b>3.5</b> 0.14	<b>151.0</b> 5.94	<b>0.8</b> 0.03	<b>184.0</b> 7.24	<b>6.93</b> 15.29
74550	74850	X11S-74550	Y17S-74850	<b>3.5</b> 0.14	<b>158.0</b> 6.22	<b>0.8</b> 0.03	<b>208.0</b> 8.19	<b>12.46</b> 27.44
898	892	X4S-898	Y5S-892	<b>3.5</b> 0.14	<b>160.0</b> 6.30	<b>1.5</b> 0.06	<b>216.0</b> 8.50	<b>18.15</b> 40.03
HH231649	HH231615	HH231649XB		<b>9.7</b> 0.38	<b>177.0</b> 6.97	<b>1.5</b> 0.06	<b>263.7</b> 10.38	<b>52.27</b> 115.25
EE750558	751200	X1S-750558	Y5S-751200	<b>3.3</b> 0.13	<b>162.0</b> 6.38	<b>1.5</b> 0.06	<b>272.0</b> 10.71	<b>57.83</b> 127.55
HH234031	HH234010	HH234031XA		<b>9.7</b> 0.38	<b>180.0</b> 7.09	<b>2.3</b> 0.09	<b>285.5</b> 11.24	<b>68.72</b> 151.47
X32028XM	Y32028XM	K167398	K167397	<b>2.5</b> 0.10	<b>158.0</b> 6.22	<b>0.6</b> 0.03	<b>203.0</b> 7.99	<b>11.04</b> 24.32
36690	36626	X4S-36690	Y1S-36626	<b>1.5</b> 0.06	<b>155.0</b> 6.10	<b>0.8</b> 0.03	<b>190.0</b> 7.48	<b>7.62</b> 16.81
NP655864	107105	K167806	K167807	<b>6.4</b> 0.25	<b>176.0</b> 6.93	<b>1.5</b> 0.06	<b>249.4</b> 9.82	<b>37.62</b> 82.91

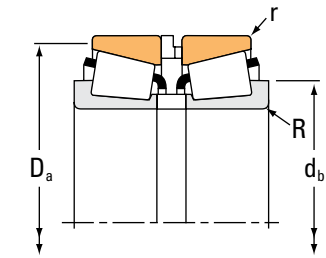
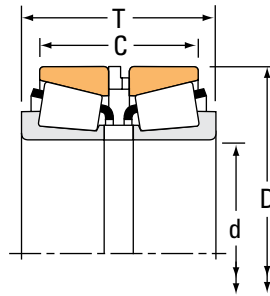
<sup>(5)</sup>Contact your Timken engineer for information on spacer configurations.

<sup>(6)</sup>These maximum fillet radii will be cleared by the bearing corners.

# TAPERED ROLLER BEARINGS

## DOUBLE-ROW • TYPE 2TS-IM

### TYPE 2TS-IM



Bearing Dimensions				Load Ratings							
Bore d	O.D. D	Width <sup>(1)</sup> T	Width C	Dynamic <sup>(2)</sup>		Factors <sup>(3)</sup>		Dynamic <sup>(4)</sup>			Factors <sup>(3)</sup>
mm in.	mm in.	mm in.	mm in.	C <sub>1(2)</sub>	e	Y <sub>1</sub>	Y <sub>2</sub>	C <sub>90</sub>	C <sub>a90</sub>	C <sub>90(2)</sub>	K
N lbf	N lbf	N lbf	N lbf	N lbf	N lbf	N lbf	N lbf	N lbf	N lbf	N lbf	N lbf
146.050 5.7500	304.800 12.0000	190.500 7.5000	127.000 5.0000	2020000 453000	0.73	0.93	1.38	300000 67500	374000 84100	522000 117000	0.80
146.050 5.7500	304.800 12.0000	202.800 7.9843	139.300 5.4843	2020000 453000	0.73	0.93	1.38	300000 67500	374000 84100	522000 117000	0.80
146.050 5.7500	311.150 12.2500	190.500 7.5000	127.000 5.0000	2020000 453000	0.73	0.93	1.38	300000 67500	374000 84100	522000 117000	0.80
149.225 5.8750	236.538 9.3125	135.000 5.3150	109.600 4.3150	1040000 234000	0.32	2.12	3.15	155000 34800	84500 19000	269000 60600	1.83
149.225 5.8750	236.538 9.3125	158.000 6.2205	132.600 5.2205	1040000 234000	0.32	2.12	3.15	155000 34800	84500 19000	269000 60600	1.83
149.225 5.8750	241.300 9.5000	155.575 6.1250	130.175 5.1250	1040000 234000	0.32	2.12	3.15	155000 34800	84500 19000	269000 60600	1.83
152.400 6.0000	268.288 10.5625	165.100 6.5000	130.175 5.1250	1370000 307000	0.39	1.74	2.59	203000 45700	135000 30300	354000 79600	1.51
155.575 6.1250	330.200 13.0000	180.975 7.1250	117.475 4.6250	2140000 481000	0.81	0.83	1.24	319000 71600	441000 99200	555000 125000	0.72
155.575 6.1250	330.200 13.0000	190.500 7.5000	127.000 5.0000	2140000 481000	0.81	0.83	1.24	319000 71600	441000 99200	555000 125000	0.72
165.100 6.5000	225.425 8.8750	104.775 4.1250	88.900 3.5000	528000 119000	0.38	1.76	2.62	78600 17700	51600 11600	137000 30800	1.52
165.100 6.5000	336.550 13.2500	203.200 8.0000	158.750 6.2500	2880000 648000	0.37	1.82	2.71	429000 96500	273000 61400	748000 168000	1.57
168.275 6.6250	330.200 13.0000	184.150 7.2500	120.650 4.7500	2140000 481000	0.81	0.83	1.24	319000 71600	441000 99200	555000 125000	0.72
168.275 6.6250	330.200 13.0000	190.500 7.5000	127.000 5.0000	2140000 481000	0.81	0.83	1.24	319000 71600	441000 99200	555000 125000	0.72
168.275 6.6250	342.900 13.5000	180.975 7.1250	117.475 4.6250	2140000 481000	0.81	0.83	1.24	319000 71600	441000 99200	555000 125000	0.72
169.975 6.6919	260.350 10.2500	149.225 5.8750	120.650 4.7500	1140000 256000	0.40	1.68	2.50	169000 38100	117000 26200	295000 66300	1.45
170.000 6.6929	230.000 9.0551	87.239 3.4346	71.242 2.8048	583000 131000	0.38	1.76	2.62	86800 19500	56900 12800	151000 34000	1.52
170.000 6.6929	240.000 9.4488	100.278 3.9479	82.278 3.2393	699000 157000	0.44	1.54	2.30	104000 23400	77900 17500	181000 40700	1.34

<sup>(1)</sup>Overall width can vary depending on spacer selection. Contact your Timken engineer for more information.

<sup>(2)</sup>Based on  $1 \times 10^6$  revolutions  $L_{10}$  life, for the ISO life-calculation method.  $C_{1(2)}$  is the double-row radial value.

<sup>(3)</sup>Consult your Timken engineer for instructions on use or review the Timken Engineering Manual on [timken.com/catalogs](http://timken.com/catalogs).

<sup>(4)</sup>Based on  $90 \times 10^6$  revolutions  $L_{10}$  life, for The Timken Company life-calculation method.  $C_{90}$  and  $C_{a90}$  are radial and thrust values for single-row.

$C_{90(2)}$  is the double-row radial value.

Part Number				Dimensions				Bearing Weight
Inner	Outer	Inner Spacer <sup>(5)</sup>	Outer Spacer <sup>(5)</sup>	Shaft		Housing		
				Max. Shaft Fillet Radius	Backing Shoulder Dia.	Max. Housing Fillet Radius	Backing Shoulder Dia.	
				R <sup>(6)</sup>	d <sub>b</sub>	r <sup>(6)</sup>	D <sub>a</sub>	
				mm	mm	mm	mm	kg
				in.	in.	in.	in.	lbs.
HH932145	HH932110	HH932145XA	HH932110EB	6.4 0.25	195.0 7.68	1.5 0.06	288.0 11.34	56.95 125.55
HH932145	HH932110	HH932145XE		6.4 0.25	195.0 7.68	1.5 0.06	288.0 11.34	55.68 122.76
HH932145	HH932115	HH932145XA	HH932115EC	6.4 0.25	195.0 7.68	1.5 0.06	288.0 11.34	60.41 133.18
HM231148	HM231110	HM231148XB	HM231110EE	6.4 0.25	172.0 6.77	1.5 0.06	224.0 8.82	19.80 43.61
HM231148	HM231110	HM231148XE	HM231110ES	6.4 0.25	172.0 6.77	1.5 0.06	224.0 8.82	22.18 48.85
HM231149	HM231115	HM231149XC	HM231115EC	3.5 0.14	167.0 6.57	1.5 0.06	224.0 8.82	22.24 49.01
EE107060	107105	X7S-99600	K160929	6.4 0.25	181.0 7.13	1.5 0.06	249.4 9.82	35.45 78.13
H936340	H936310	H936340XE	H936310EE	6.4 0.25	209.0 8.23	1.5 0.06	311.4 12.26	66.72 147.09
H936340	H936310	H936340XA	H936310EC	6.4 0.25	209.0 8.23	1.5 0.06	311.4 12.26	68.83 151.74
46790	46720	X4S-46790	K160550	3.5 0.14	181.0 7.13	0.8 0.03	218.0 8.58	11.24 24.77
HH437549	HH437510	HH437549XA		3.3 0.13	196.0 7.72	1.5 0.06	307.7 12.12	75.73 166.96
H936349	H936310	H936349XC	H936310EG	6.4 0.25	218.0 8.58	1.5 0.06	311.4 12.26	63.04 138.98
H936349	H936310	H936349XS	H936310EC	6.4 0.25	218.0 8.58	1.5 0.06	311.4 12.26	64.39 141.94
H936349	H936316	H936349XB	H936316EG	6.4 0.25	218.0 8.58	1.5 0.06	311.4 12.26	67.71 149.26
HM535347	HM535310	HM535347XA	HM535310ES	3.5 0.14	192.0 7.56	0.8 0.03	250.0 9.84	27.57 60.79
JHM534149	JHM534110	HM534149XA	HM534110ES	3.0 0.12	184.0 7.24	0.4 0.02	224.0 8.82	9.09 19.99
JM734449	JM734410	M734449XB	M734410ES	3.0 0.12	185.0 7.28	1.5 0.06	232.0 9.13	13.18 29.04

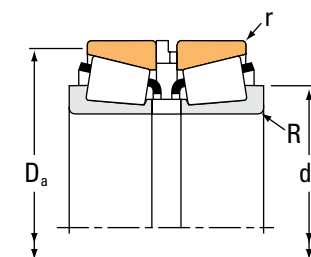
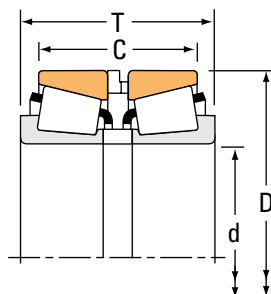
<sup>(5)</sup>Contact your Timken engineer for information on spacer configurations.

<sup>(6)</sup>These maximum fillet radii will be cleared by the bearing corners.

# TAPERED ROLLER BEARINGS

## DOUBLE-ROW • TYPE 2TS-IM

### TYPE 2TS-IM



Bearing Dimensions				Load Ratings							
Bore d	O.D. D	Width <sup>(1)</sup> T	Width C	Dynamic <sup>(2)</sup>				Dynamic <sup>(4)</sup>			
				C <sub>1(2)</sub>	e	Factors <sup>(3)</sup> Y <sub>1</sub>	Y <sub>2</sub>	C <sub>90</sub>	C <sub>a90</sub>	C <sub>90(2)</sub>	Factors <sup>(3)</sup> K
mm in.	mm in.	mm in.	mm in.	N lbf				N lbf	N lbf	N lbf	
170.000 6.6929	240.000 9.4488	100.278 3.9479	82.278 3.2393	667000 150000	0.44	1.54	2.30	99300 22300	74300 16700	173000 38900	1.34
171.450 6.7500	260.350 10.2500	147.498 5.8070	118.922 4.6820	1140000 256000	0.40	1.68	2.50	169000 38100	117000 26200	295000 66300	1.45
171.450 6.7500	260.350 10.2500	155.575 6.1250	127.000 5.0000	1140000 256000	0.40	1.68	2.50	169000 38100	117000 26200	295000 66300	1.45
171.450 6.7500	260.350 10.2500	203.200 8.0000	174.625 6.8750	1140000 256000	0.40	1.68	2.50	169000 38100	117000 26200	295000 66300	1.45
174.625 6.8750	298.450 11.7500	185.738 7.3125	147.638 5.8125	1610000 363000	0.38	1.79	2.66	240000 54000	155000 34900	419000 94100	1.55
174.625 6.8750	311.150 12.2500	184.150 7.2500	149.225 5.8750	1950000 438000	0.33	2.04	3.04	290000 65200	164000 36900	505000 114000	1.77
177.800 7.0000	247.650 9.7500	103.188 4.0625	84.138 3.3125	705000 159000	0.44	1.54	2.29	105000 23600	79000 17800	183000 41100	1.33
177.800 7.0000	247.650 9.7500	106.362 4.1875	87.312 3.4375	705000 159000	0.44	1.54	2.29	105000 23600	79000 17800	183000 41100	1.33
177.800 7.0000	288.925 11.3750	142.875 5.6250	111.125 4.3750	1700000 382000	0.32	2.12	3.15	253000 56900	138000 31100	441000 99100	1.83
177.800 7.0000	288.925 11.3750	158.750 6.2500	127.000 5.0000	1150000 258000	0.47	1.44	2.15	171000 38500	137000 30800	298000 67000	1.25
177.800 7.0000	355.600 14.0000	190.500 7.5000	139.700 5.5000	1850000 416000	0.55	1.24	1.84	276000 62000	258000 57900	480000 108000	1.07
177.800 7.0000	428.625 16.8750	228.600 9.0000	139.700 5.5000	2620000 588000	0.76	0.89	1.33	390000 87600	506000 114000	679000 153000	0.77
180.000 7.0866	250.000 9.8425	102.288 4.0271	82.288 3.2397	712000 160000	0.48	1.41	2.09	106000 23800	87200 19600	185000 41500	1.22
189.949 7.4783	290.000 11.4173	138.000 5.4331	107.396 4.2282	975000 219000	0.33	2.03	3.02	145000 32600	82600 18600	253000 56800	1.76
190.000 7.4803	260.000 10.2362	101.262 3.9867	82.263 3.2387	708000 159000	0.48	1.41	2.11	105000 23700	86200 19400	184000 41300	1.22
190.000 7.4803	290.000 11.4173	146.000 5.7480	114.000 4.4882	1250000 281000	0.44	1.53	2.27	186000 41900	141000 31700	325000 73000	1.32
190.500 7.5000	336.550 13.2500	209.550 8.2500	158.750 6.2500	2010000 451000	0.58	1.17	1.75	299000 67100	294000 66200	520000 117000	1.01

<sup>(1)</sup>Overall width can vary depending on spacer selection. Contact your Timken engineer for more information.

<sup>(2)</sup>Based on  $1 \times 10^6$  revolutions  $L_{10}$  life, for the ISO life-calculation method.  $C_{1(2)}$  is the double-row radial value.

<sup>(3)</sup>Consult your Timken engineer for instructions on use or review the Timken Engineering Manual on [timken.com/catalogs](http://timken.com/catalogs).

<sup>(4)</sup>Based on  $90 \times 10^6$  revolutions  $L_{10}$  life, for The Timken Company life-calculation method.  $C_{90}$  and  $C_{a90}$  are radial and thrust values for single-row.  $C_{90(2)}$  is the double-row radial value.

Part Number				Dimensions				Bearing Weight
Inner	Outer	Inner Spacer <sup>(5)</sup>	Outer Spacer <sup>(5)</sup>	Shaft		Housing		
				Max. Shaft Fillet Radius	Backing Shoulder Dia.	Max. Housing Fillet Radius	Backing Shoulder Dia.	
				R <sup>(6)</sup>	d <sub>b</sub>	r <sup>(6)</sup>	D <sub>a</sub>	
				mm in.	mm in.	mm in.	mm in.	kg lbs.
JM734449A	JM734410	M734449XB	M734410ES	3.0 0.12	185.0 7.28	1.5 0.06	232.0 9.13	13.14 28.94
HM535349	HM535310	HM535349XE	HM535310EX	3.5 0.14	192.0 7.56	0.8 0.03	250.0 9.84	25.96 57.25
HM535349	HM535310	HM535349XS	HM535310EW	3.5 0.14	192.0 7.56	0.8 0.03	250.0 9.84	26.60 58.66
HM535349	HM535310	HM535349XB	HM535310EE	3.5 0.14	192.0 7.56	0.8 0.03	250.0 9.84	31.72 69.94
EE219068	219117	X2S-219068	Y1S-219117	6.4 0.25	204.0 8.03	1.5 0.06	282.0 11.10	48.04 105.93
H238148	H238110	H238148XA		6.4 0.25	205.0 8.07	1.5 0.06	289.0 11.36	52.37 115.45
67790	67720	K164782	K164781	3.5 0.14	194.0 7.64	0.8 0.03	240.0 9.45	13.77 30.35
67790	67720	X6S-67790	Y9S-67720	3.5 0.14	194.0 7.64	0.8 0.03	240.0 9.45	14.13 31.16
HM237545	HM237510	HM237545XC	HM237510CA	7.0 0.28	205.0 8.07	1.5 0.06	271.3 10.68	32.11 70.82
94700	94113	X13S-94700	Y20S-94113	7.0 0.28	207.0 8.15	1.5 0.06	272.0 10.71	35.99 79.37
EE607070	607140	X2S-607070	Y4S-607140	6.4 0.25	214.1 8.43	1.5 0.06	326.1 12.84	77.38 170.63
EE350701	351687	X2S-350701	Y2S-351687	6.4 0.25	230.0 9.06	1.5 0.06	383.0 15.08	140.04 308.70
JM736149	JM736110	M736149XC	M736110ES	3.0 0.12	196.0 7.72	1.0 0.04	242.6 9.55	14.04 30.94
JM241538	JM241511		M241511EA	3.0 0.12	211.0 8.31	1.5 0.06	280.0 11.02	30.43 67.06
JM738249	JM738210	M738249XB	M738210ES	3.0 0.12	206.0 8.11	1.0 0.04	252.0 9.92	14.43 31.79
X32038XM	Y32038XM	K161907	K161906	3.0 0.12	214.0 8.43	1.0 0.04	281.0 11.06	31.16 68.69
HH840249	HH840210	HH840249XA	HH840210EB	6.4 0.25	234.0 9.21	1.5 0.06	318.0 12.52	73.98 163.10

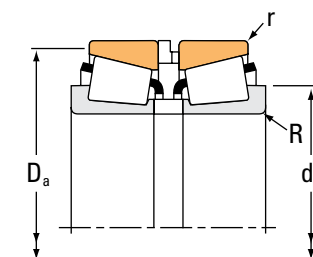
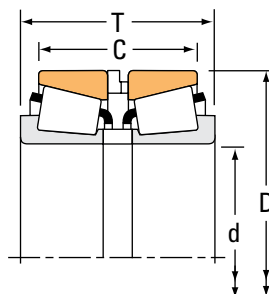
<sup>(5)</sup>Contact your Timken engineer for information on spacer configurations.

<sup>(6)</sup>These maximum fillet radii will be cleared by the bearing corners.

# TAPERED ROLLER BEARINGS

## DOUBLE-ROW • TYPE 2TS-IM

### TYPE 2TS-IM



Bearing Dimensions				Load Ratings							
Bore d	O.D. D	Width <sup>(1)</sup> T	Width C	Dynamic <sup>(2)</sup>		Factors <sup>(3)</sup>		Dynamic <sup>(4)</sup>			Factors <sup>(3)</sup>
mm in.	mm in.	mm in.	mm in.	C <sub>1(2)</sub>	e	Y <sub>1</sub>	Y <sub>2</sub>	C <sub>90</sub>	C <sub>a90</sub>	C <sub>90(2)</sub>	K
N lbf	N lbf	N lbf	N lbf	N lbf	N lbf	N lbf	N lbf	N lbf	N lbf	N lbf	N lbf
190.500 7.5000	336.550 13.2500	209.550 8.2500	171.450 6.7500	1640000 370000	0.37	1.85	2.75	245000 55000	153000 34400	426000 95800	1.60
190.500 7.5000	428.625 16.8750	228.600 9.0000	139.700 5.5000	2860000 644000	0.76	0.89	1.33	426000 95900	554000 124000	742000 167000	0.77
196.850 7.7500	257.175 10.1250	139.700 5.5000	120.649 4.7500	554000 125000	0.45	1.51	2.25	82500 18600	63100 14200	144000 32300	1.31
200.000 7.8740	300.000 11.8110	141.000 5.5512	113.000 4.4488	1210000 272000	0.52	1.29	1.93	180000 40500	161000 36200	314000 70500	1.12
200.025 7.8750	333.375 13.1250	292.100 11.5000	257.175 10.1250	1600000 359000	0.44	1.54	2.29	238000 53400	179000 40200	414000 93000	1.33
203.200 8.0000	282.575 11.1250	101.600 4.0000	82.549 3.2500	875000 197000	0.51	1.33	1.97	130000 29300	114000 25500	227000 51000	1.15
203.200 8.0000	317.500 12.5000	146.050 5.7500	111.125 4.3750	1270000 286000	0.52	1.29	1.92	190000 42600	170000 38200	330000 74200	1.12
203.200 8.0000	482.600 19.0000	260.350 10.2500	171.450 6.7500	2870000 646000	0.87	0.78	1.16	428000 96200	635000 143000	745000 168000	0.67
206.375 8.1250	336.550 13.2500	298.450 11.7500	257.175 10.1250	2360000 530000	0.33	2.03	3.02	351000 79000	200000 45000	612000 137000	1.76
209.550 8.2500	317.500 12.5000	146.050 5.7500	111.125 4.3750	1270000 286000	0.52	1.29	1.92	190000 42600	170000 38200	330000 74200	1.12
215.900 8.5000	285.750 11.2500	138.074 5.4360	115.849 4.5610	748000 168000	0.48	1.40	2.09	111000 25000	91800 20600	194000 43600	1.21
220.000 8.6614	340.000 13.3858	165.000 6.4960	127.000 5.0000	1730000 389000	0.43	1.57	2.34	258000 57900	190000 42700	449000 101000	1.36
220.662 8.6875	314.325 12.3750	131.762 5.1875	106.362 4.1875	1210000 272000	0.33	2.03	3.02	180000 40500	103000 23100	314000 70500	1.76
228.600 9.0000	300.038 11.8125	76.200 3.0000	76.200 3.0000	414000 93000	0.40	1.68	2.50	61600 13900	42400 9530	107000 24100	1.45
228.600 9.0000	355.600 14.0000	254.000 10.0000	212.725 8.3750	1320000 297000	0.59	1.14	1.70	197000 44200	199000 44700	343000 77000	0.99
234.950 9.2500	384.175 15.1250	302.260 11.9000	257.810 10.1500	2920000 656000	0.33	2.03	3.02	434000 97600	247000 55600	756000 170000	1.76
241.300 9.5000	327.025 12.8750	114.300 4.5000	82.550 3.2500	918000 206000	0.41	1.66	2.47	137000 30700	95200 21400	238000 53500	1.44

<sup>(1)</sup>Overall width can vary depending on spacer selection. Contact your Timken engineer for more information.

<sup>(2)</sup>Based on  $1 \times 10^6$  revolutions  $L_{10}$  life, for the ISO life-calculation method.  $C_{1(2)}$  is the double-row radial value.

<sup>(3)</sup>Consult your Timken engineer for instructions on use or review the Timken Engineering Manual on [timken.com/catalogs](http://timken.com/catalogs).

<sup>(4)</sup>Based on  $90 \times 10^6$  revolutions  $L_{10}$  life, for The Timken Company life-calculation method.  $C_{90}$  and  $C_{a90}$  are radial and thrust values for single-row.

$C_{90(2)}$  is the double-row radial value.

Part Number				Dimensions				Bearing Weight
Inner	Outer	Inner Spacer <sup>(5)</sup>	Outer Spacer <sup>(5)</sup>	Shaft		Housing		
				Max. Shaft Fillet Radius R <sup>(6)</sup>	Backing Shoulder Dia. d <sub>b</sub>	Max. Housing Fillet Radius r <sup>(6)</sup>	Backing Shoulder Dia. D <sub>a</sub>	
				mm in.	mm in.	mm in.	mm in.	kg lbs.
470975	470132	K161993	K161994	4.8 0.19	217.0 8.54	1.5 0.06	306.5 12.07	65.05 143.43
EE350750	351687	X3S-350750	Y2S-351687	6.4 0.25	240.0 9.45	1.5 0.06	383.0 15.08	134.55 296.63
LM739749	LM739710	LM739749XE	LM739710EA	3.5 0.14	213.0 8.39	0.8 0.03	251.0 9.88	17.23 38.00
JHM840449	JHM840410	HM840449XA	HM840410EA	3.5 0.14	226.0 8.90	1.5 0.06	288.9 11.37	32.47 71.60
HM743337	HM743310	HM743337XB		6.4 0.25	231.0 9.09	1.5 0.06	317.0 12.48	60.60 133.62
67983	67920	X2S-67983	Y10S-67920	3.5 0.14	222.0 8.74	0.8 0.03	275.0 10.83	18.49 40.80
93800	93125	X4S-93800	Y14S-93125	4.3 0.17	227.0 8.94	1.5 0.06	300.0 11.81	38.40 84.68
EE380080	380190	X1S-380081	Y1S-380190	6.4 0.25	280.0 11.02	1.5 0.06	428.5 16.87	208.60 459.85
H242649	H242610	K163370		3.3 0.13	231.0 9.09	1.5 0.06	318.0 12.51	71.34 157.29
93825	93125	X1S-93825		4.3 0.17	233.0 9.17	1.5 0.06	300.0 11.81	34.37 75.78
LM742749	LM742710	LM742749XE		3.5 0.14	233.0 9.17	0.8 0.03	279.0 10.98	17.11 37.69
X32044XM	Y32044XM	K165766	K165765	4.0 0.16	248.0 9.76	1.5 0.06	325.0 12.80	49.99 110.23
M244249	M244210	M244249XA	M244210ER	6.4 0.25	245.0 9.65	1.5 0.06	300.0 11.81	29.87 65.87
544090	544118	X1S-544090	Y3S-544118	3.5 0.14	244.0 9.61	0.8 0.03	287.0 11.30	12.22 26.90
96900	96140	X6S-96900	Y9S-96140	7.0 0.28	260.0 10.24	0.8 0.03	334.0 13.15	69.98 154.32
H247549	H247510	H247549XE	H247510EF	6.4 0.25	273.0 10.75	1.5 0.06	362.5 14.27	118.22 260.64
8578	8520	X1S-8578	Y7S-8520	6.4 0.25	264.0 10.39	0.8 0.03	313.0 12.32	23.66 52.19

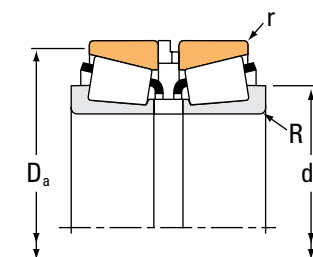
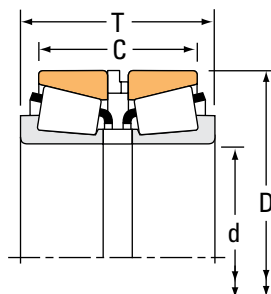
<sup>(5)</sup>Contact your Timken engineer for information on spacer configurations.

<sup>(6)</sup>These maximum fillet radii will be cleared by the bearing corners.

# TAPERED ROLLER BEARINGS

## DOUBLE-ROW • TYPE 2TS-IM

### TYPE 2TS-IM



Bearing Dimensions				Load Ratings							
Bore d	O.D. D	Width <sup>(1)</sup> T	Width C	Dynamic <sup>(2)</sup>				Dynamic <sup>(4)</sup>			
				C <sub>1(2)</sub>	e	Factors <sup>(3)</sup> Y <sub>1</sub>	Y <sub>2</sub>	C <sub>90</sub>	C <sub>a90</sub>	C <sub>90(2)</sub>	Factors <sup>(3)</sup> K
mm in.	mm in.	mm in.	mm in.	N lbf				N lbf	N lbf	N lbf	
247.650 9.7500	406.400 16.0000	247.675 9.7510	203.225 8.0010	4290000 965000	0.33	2.03	3.02	639000 144000	364000 81800	1110000 250000	1.76
254.000 10.0000	358.775 14.1250	159.000 6.2598	124.074 4.8848	1450000 327000	0.33	2.03	3.02	217000 48700	123000 27700	377000 84800	1.76
257.175 10.1250	342.900 13.5000	215.900 8.5000	190.500 7.5000	1360000 305000	0.35	1.94	2.89	202000 45500	120000 27000	352000 79200	1.68
257.175 10.1250	358.775 14.1250	161.926 6.3750	127.000 5.0000	1450000 327000	0.33	2.03	3.02	217000 48700	123000 27700	377000 84800	1.76
266.700 10.5000	444.500 17.5000	266.700 10.5000	203.200 8.0000	3180000 714000	0.58	1.17	1.75	473000 106000	466000 105000	823000 185000	1.01
279.982 11.0229	380.009 14.9610	160.175 6.3061	128.425 5.0561	1260000 283000	0.43	1.56	2.33	187000 42100	138000 31100	326000 73300	1.35
288.925 11.3750	406.400 16.0000	165.100 6.5000	130.175 5.1250	2070000 466000	0.34	2.00	2.97	308000 69300	179000 40100	537000 121000	1.73
304.800 12.0000	406.400 16.0000	159.000 6.2598	127.250 5.0098	1340000 301000	0.44	1.53	2.28	199000 44800	151000 33900	347000 78100	1.32
317.500 12.5000	444.500 17.5000	146.050 5.7500	98.425 3.8750	1540000 347000	0.38	1.79	2.66	230000 51700	149000 33400	400000 90000	1.55
317.500 12.5000	622.300 24.5000	304.800 12.0000	174.625 6.8750	5500000 1240000	0.94	0.72	1.07	819000 184000	1310000 295000	1430000 321000	0.62
355.600 14.0000	444.500 17.5000	127.000 5.0000	101.600 4.0000	1280000 287000	0.31	2.20	3.27	190000 42700	100000 22500	331000 74400	1.90
355.600 14.0000	482.600 19.0000	133.350 5.2500	88.900 3.5000	1090000 246000	0.50	1.35	2.01	163000 36600	140000 31400	284000 63800	1.17
361.950 14.2500	406.400 16.0000	72.746 2.8640	60.046 2.3640	345000 77500	0.40	1.68	2.50	51300 11500	35300 7940	89400 20100	1.45
381.000 15.0000	479.425 18.8750	113.424 4.4655	84.850 3.3405	1030000 232000	0.50	1.36	2.03	154000 34600	130000 29300	268000 60300	1.18
406.400 16.0000	508.000 20.0000	174.884 6.8852	146.309 5.7602	1500000 336000	0.37	1.85	2.75	223000 50100	139000 31300	388000 87200	1.60
476.250 18.7500	565.150 22.2500	95.250 3.7500	76.200 3.0000	817000 184000	0.47	1.44	2.14	122000 27400	97800 22000	212000 47600	1.24
476.250 18.7500	565.150 22.2500	127.000 5.0000	107.950 4.2500	817000 184000	0.47	1.44	2.14	122000 27400	97800 22000	212000 47600	1.24

<sup>(1)</sup>Overall width can vary depending on spacer selection. Contact your Timken engineer for more information.

<sup>(2)</sup>Based on  $1 \times 10^6$  revolutions  $L_{10}$  life, for the ISO life-calculation method.  $C_{1(2)}$  is the double-row radial value.

<sup>(3)</sup>Consult your Timken engineer for instructions on use or review the Timken Engineering Manual on [timken.com/catalogs](http://timken.com/catalogs).

<sup>(4)</sup>Based on  $90 \times 10^6$  revolutions  $L_{10}$  life, for The Timken Company life-calculation method.  $C_{90}$  and  $C_{a90}$  are radial and thrust values for single-row.  $C_{90(2)}$  is the double-row radial value.



Part Number				Dimensions				Bearing Weight
Inner	Outer	Inner Spacer <sup>(5)</sup>	Outer Spacer <sup>(5)</sup>	Shaft		Housing		
				Max. Shaft Fillet Radius	Backing Shoulder Dia.	Max. Housing Fillet Radius	Backing Shoulder Dia.	
				R <sup>(6)</sup>	d <sub>b</sub>	r <sup>(6)</sup>	D <sub>a</sub>	
				mm	mm	mm	mm	kg
				in.	in.	in.	in.	lbs.
HH249949H	HH249910	HH249949XA		6.4 0.25	288.0 11.34	1.5 0.06	383.0 15.08	121.91 268.77
M249749AH	M249710	M249749XS	M249710EW	1.5 0.06	270.0 10.63	1.5 0.06	343.0 13.50	45.20 99.68
M349549	M349510	M349549XA	M349510EA	6.4 0.25	281.0 11.06	0.8 0.03	333.0 13.11	43.51 95.91
M249747	M249710	M249747XB	M249710EX	1.5 0.06	272.0 10.71	1.5 0.06	343.0 13.50	43.67 96.26
H852849	H852810	H852849XA	H852810EA	6.4 0.25	315.0 12.40	1.5 0.06	422.3 16.63	153.67 338.81
LM654642	LM654611	LM654642XA	LM654611EA	3.5 0.14	302.0 11.89	1.5 0.06	368.0 14.49	47.07 103.76
M255449	M255410	M255449XB		6.4 0.25	316.0 12.44	1.5 0.06	387.9 15.27	62.37 137.51
LM757049	LM757010	LM757049XC	LM757010EC	6.4 0.25	331.0 13.03	1.5 0.06	393.0 15.47	50.93 112.26
EE291250	291750	X1S-291250	Y7S-291750	8.0 0.31	346.0 13.62	1.5 0.06	415.0 16.34	53.55 118.07
H961649	H961610	H961649XA	H961610EB	14.3 0.56	410.0 16.14	3.3 0.13	581.6 22.90	368.76 812.92
L163149	L163110	L163149XS	L163110EC	3.5 0.14	374.0 14.72	1.5 0.06	430.0 16.93	42.90 94.59
EE161400	161900	X1S-161400	Y9S-161900	7.0 0.28	386.0 15.20	1.5 0.06	455.0 17.91	54.23 119.54
LL562749	LL562710	LL562749XB	LL562710EB	2.3 0.09	372.0 14.65	0.8 0.03	401.0 15.79	10.25 22.58
L865547	L865512	L865547XA		6.4 0.25	407.0 16.02	1.5 0.06	465.0 18.31	38.54 84.95
L467549	L467510	K164387		3.3 0.13	426.0 16.77	1.5 0.06	492.0 19.37	58.69 129.41
LL771948	LL771911	LL771948XB	LL771911EC	3.3 0.13	495.0 19.49	1.5 0.06	549.0 21.61	42.74 94.22
LL771948	LL771911	LL771948XA	LL771911EB	3.3 0.13	495.0 19.49	1.5 0.06	549.0 21.61	51.17 112.81

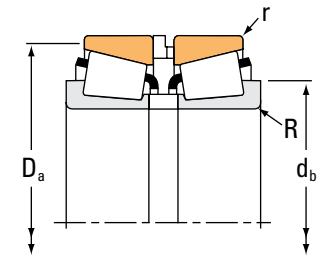
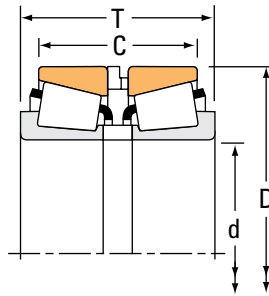
<sup>(5)</sup>Contact your Timken engineer for information on spacer configurations.

<sup>(6)</sup>These maximum fillet radii will be cleared by the bearing corners.

# TAPERED ROLLER BEARINGS

## DOUBLE-ROW • TYPE 2TS-IM

### TYPE 2TS-IM



Bearing Dimensions				Load Ratings							
Bore d	O.D. D	Width <sup>(1)</sup> T	Width C	Dynamic <sup>(2)</sup>				Dynamic <sup>(4)</sup>			
				C <sub>1(2)</sub>	e	Factors <sup>(3)</sup> Y <sub>1</sub>	Y <sub>2</sub>	C <sub>90</sub>	C <sub>a90</sub>	C <sub>90(2)</sub>	Factors <sup>(3)</sup> K
mm in.	mm in.	mm in.	mm in.	N lbf				N lbf	N lbf	N lbf	
482.600 19.0000	615.950 24.2500	107.950 4.2500	82.550 3.2500	1140000 257000	0.35	1.93	2.88	170000 38200	102000 22900	296000 66600	1.67
488.950 19.2500	634.873 24.9950	209.990 8.2673	165.538 6.5173	3240000 728000	0.47	1.43	2.12	482000 108000	390000 87800	840000 189000	1.24
488.950 19.2500	634.873 24.9950	227.990 8.9760	183.540 7.2260	3240000 728000	0.47	1.43	2.12	482000 108000	390000 87800	840000 189000	1.24
539.750 21.2500	635.000 25.0000	120.650 4.7500	95.250 3.7500	1550000 349000	0.41	1.66	2.48	231000 52000	161000 36100	403000 90500	1.44
558.800 22.0000	736.600 29.0000	225.425 8.8875	177.800 7.0000	4980000 1120000	0.35	1.95	2.90	741000 167000	439000 98800	1290000 290000	1.69
584.200 23.0000	685.800 27.0000	107.950 4.2500	79.375 3.1250	1390000 312000	0.44	1.54	2.30	207000 46500	155000 34800	360000 81000	1.34
673.100 26.5000	793.750 31.2500	149.225 5.8750	114.299 4.5000	1930000 434000	0.36	1.87	2.79	287000 64600	177000 39800	500000 112000	1.62
736.600 29.0000	825.500 32.5000	114.300 4.5000	101.600 4.0000	738000 166000	0.40	1.70	2.53	110000 24700	74800 16800	191000 43000	1.47
762.000 30.0000	889.000 35.0000	158.100 6.2244	120.000 4.7244	2730000 613000	0.38	1.78	2.65	406000 91400	263000 59200	707000 159000	1.54
1155.700 45.5000	1435.100 56.5000	267.051 10.5138	216.251 8.5138	7030000 1580000	0.36	1.87	2.78	1050000 235000	647000 146000	1820000 410000	1.62
1562.100 61.5000	1806.575 71.1250	266.700 10.5000	184.150 7.2500	7900000 1780000	0.47	1.42	2.12	1180000 265000	955000 215000	2050000 461000	1.23

<sup>(1)</sup>Overall width can vary depending on spacer selection. Contact your Timken engineer for more information.

<sup>(2)</sup>Based on  $1 \times 10^6$  revolutions  $L_{10}$  life, for the ISO life-calculation method.  $C_{1(2)}$  is the double-row radial value.

<sup>(3)</sup>Consult your Timken engineer for instructions on use or review the Timken Engineering Manual on [timken.com/catalogs](http://timken.com/catalogs).

<sup>(4)</sup>Based on  $90 \times 10^6$  revolutions  $L_{10}$  life, for The Timken Company life-calculation method.  $C_{90}$  and  $C_{a90}$  are radial and thrust values.  $C_{90(2)}$  is the double-row radial value.

Part Number				Dimensions				Bearing Weight
Inner	Outer	Inner Spacer <sup>(5)</sup>	Outer Spacer <sup>(5)</sup>	Shaft		Housing		
				Max. Shaft Fillet Radius	Backing Shoulder Dia.	Max. Housing Fillet Radius	Backing Shoulder Dia.	
				R <sup>(6)</sup>	d <sub>b</sub>	r <sup>(6)</sup>	D <sub>a</sub>	
				mm	mm	mm	mm	kg
				in.	in.	in.	in.	lbs.
80480	80425	X3S-80480		<b>3.3</b> 0.13	<b>504.0</b> 19.84	<b>1.5</b> 0.06	<b>579.0</b> 22.80	<b>71.57</b> 157.75
LM772748	LM772710	LM772748XR		<b>6.4</b> 0.25	<b>522.0</b> 20.55	<b>1.5</b> 0.06	<b>613.3</b> 24.15	<b>135.16</b> 297.99
LM772748	LM772710	LM772748XS		<b>6.4</b> 0.25	<b>522.0</b> 20.55	<b>1.5</b> 0.06	<b>613.3</b> 24.15	<b>137.63</b> 303.43
LL575349	LL575310	LL575349XA	LL575310EA	<b>6.4</b> 0.25	<b>564.0</b> 22.20	<b>1.5</b> 0.06	<b>621.0</b> 24.45	<b>55.46</b> 122.28
LM377449H	LM377410	LM377449XB	K160687	<b>6.4</b> 0.25	<b>594.0</b> 23.39	<b>1.5</b> 0.06	<b>708.0</b> 27.87	<b>238.25</b> 525.26
LL778149	LL778110	LL778149XA	LL778110EA	<b>3.5</b> 0.14	<b>603.0</b> 23.74	<b>0.8</b> 0.03	<b>669.0</b> 26.34	<b>60.96</b> 134.38
LL481448	LL481411	LL481448XA	LL481411EB	<b>6.4</b> 0.25	<b>702.0</b> 27.64	<b>1.5</b> 0.06	<b>771.0</b> 30.35	<b>113.30</b> 249.80
LL582949	LL582910	K162749	K162748	<b>3.5</b> 0.14	<b>753.1</b> 29.65	<b>1.5</b> 0.06	<b>822.0</b> 32.36	<b>55.89</b> 123.17
LL483449	LL483418	LL483449XA	LL483418EA	<b>3.3</b> 0.13	<b>783.0</b> 30.83	<b>1.5</b> 0.06	<b>858.0</b> 33.78	<b>146.64</b> 323.31
EE277455	277565	X2S-277455	Y1S-277565	<b>6.4</b> 0.25	<b>1205.0</b> 47.44	<b>3.3</b> 0.13	<b>1370.0</b> 53.94	<b>931.80</b> 2054.23
EE299615	299711X	X2S-299615	Y3S-299711	<b>9.7</b> 0.38	<b>1615.0</b> 63.58	<b>3.3</b> 0.13	<b>1757.5</b> 69.19	<b>994.87</b> 2193.30

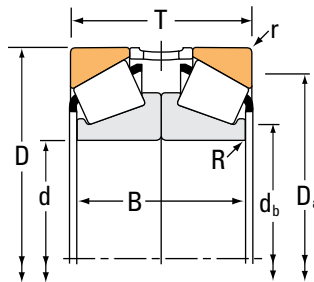
<sup>(5)</sup> Contact your Timken engineer for information on spacer configurations.

<sup>(6)</sup> These maximum fillet radii will be cleared by the bearing corners.

# TAPERED ROLLER BEARINGS

## DOUBLE-ROW • TYPE 2TS-DM

### TYPE 2TS-DM



Bearing Dimensions				Load Ratings							
Bore d	O.D. D	Width <sup>(1)</sup> T	Width B	Dynamic <sup>(2)</sup>				Dynamic <sup>(4)</sup>			
				C <sub>1(2)</sub>	e	Factors <sup>(3)</sup> Y <sub>1</sub>	Y <sub>2</sub>	C <sub>90</sub>	C <sub>a90</sub>	C <sub>90(2)</sub>	Factors <sup>(3)</sup> K
mm in.	mm in.	mm in.	mm in.	N lbf				N lbf	N lbf	N lbf	
25.000 0.9843	52.000 2.0472	38.500 1.5158	36.000 1.4174	81800 18400	0.58	1.16	1.72	12200 2740	12200 2740	21200 4770	1.00
30.000 1.1811	55.000 2.1654	34.000 1.3386	34.000 1.3386	80900 18200	0.43	1.57	2.34	12000 2710	8870 1990	21000 4710	1.36
34.925 1.3750	65.088 2.5625	36.068 1.4200	36.576 1.4400	112000 25300	0.38	1.79	2.67	16700 3760	10800 2430	29200 6550	1.55
41.275 1.6250	80.167 3.1562	50.800 2.0000	50.800 2.0000	159000 35700	0.32	2.12	3.15	23600 5310	12900 2900	41100 9240	1.83
44.450 1.7500	82.931 3.2650	47.625 1.8750	50.800 2.0000	158000 35400	0.33	2.02	3.00	23500 5270	13500 3020	40900 9180	1.74
44.450 1.7500	88.900 3.5000	60.325 2.3750	58.740 2.3126	198000 44500	0.55	1.24	1.84	29500 6630	27600 6200	51300 11500	1.07
44.450 1.7500	95.250 3.7500	61.915 2.4376	57.150 2.2500	237000 53400	0.74	0.91	1.36	35400 7950	44800 10100	61600 13800	0.79
45.000 1.7717	100.000 3.9370	54.500 2.1457	50.000 1.9686	225000 50500	0.35	1.96	2.91	33500 7530	19800 4450	58300 13100	1.69
48.412 1.9060	95.250 3.7500	60.325 2.3750	58.740 2.3126	257000 57700	0.55	1.24	1.84	38200 8590	35700 8030	66600 15000	1.07
50.800 2.0000	88.900 3.5000	41.275 1.6250	44.450 1.7500	177000 39900	0.32	2.11	3.14	26400 5930	14400 3250	46000 10300	1.83
50.800 2.0000	112.712 4.4375	60.325 2.3750	60.096 2.3660	242000 54300	0.40	1.68	2.50	36000 8090	24800 5570	62700 14100	1.45
53.975 2.1250	95.250 3.7500	55.565 2.1876	57.150 2.2500	226000 50800	0.33	2.05	3.05	33600 7560	19000 4270	58600 13200	1.77
53.975 2.1250	104.775 4.1250	73.025 2.8750	73.024 2.8750	354000 79600	0.49	1.38	2.06	52700 11900	44000 9890	91800 20600	1.20
55.000 2.1654	90.000 3.5433	46.000 1.8110	46.000 1.8110	190000 42600	0.40	1.68	2.50	28200 6340	19400 4370	49100 11000	1.45
55.000 2.1654	120.000 4.7244	58.000 2.2835	58.000 2.2834	299000 67300	0.83	0.82	1.22	44600 10000	63000 14200	77600 17500	0.71
55.562 2.1875	97.630 3.8437	49.215 1.9376	49.216 1.9376	215000 48200	0.40	1.68	2.50	32000 7180	22000 4950	55600 12500	1.45
57.150 2.2500	96.838 3.8125	42.001 1.6536	43.892 1.7280	188000 42200	0.35	1.91	2.84	28000 6280	16900 3810	48700 10900	1.65

<sup>(1)</sup>Overall width can vary depending on spacer selection. Contact your Timken engineer for more information.

<sup>(2)</sup>Based on  $1 \times 10^6$  revolutions  $L_{10}$  life, for the ISO life-calculation method.  $C_{1(2)}$  is the double-row radial value.

<sup>(3)</sup>Consult your Timken engineer for instructions on use or review the Timken Engineering Manual on [timken.com/catalogs](http://timken.com/catalogs).

<sup>(4)</sup>Based on  $90 \times 10^6$  revolutions  $L_{10}$  life, for The Timken Company life-calculation method.  $C_{90}$  and  $C_{a90}$  are radial and thrust values.  $C_{90(2)}$  is the double-row radial value.

Part Number			Dimensions				Bearing Weight
Inner	Outer	Outer Spacer <sup>(5)</sup>	Shaft		Housing		
			Max. Shaft Fillet Radius R <sup>(6)</sup>	Backing Shoulder Dia. d <sub>b</sub>	Max. Housing Fillet Radius r <sup>(6)</sup>	Max. Backing Shoulder Dia. D <sub>a</sub>	
			mm in.	mm in.	mm in.	mm in.	kg lbs.
X32205-B	Y32205-B	JY5209R	0.3 0.01	31.0 1.22	1.0 0.04	43.5 1.71	0.40 0.88
X32006X	Y32006X	JY5508-S	0.3 0.01	36.0 1.42	1.0 0.04	49.0 1.93	0.37 0.79
LM48548	LM48510	LM48510EE	0.4 0.02	41.5 1.63	1.3 0.05	58.0 2.28	0.52 1.12
26885	26820	Y1S-26820	0.3 0.01	47.0 1.85	3.3 0.13	69.0 2.72	1.15 2.57
25580	25520	Y4S-25520	0.4 0.02	50.0 1.97	0.8 0.03	74.0 2.91	1.18 2.58
HM803149	HM803110	HM803110EB	0.3 0.01	53.4 2.10	3.3 0.13	74.0 2.91	1.76 3.88
HM903249	HM903210	HM903210ES	0.3 0.01	54.0 2.13	0.8 0.03	81.0 3.19	2.08 4.60
X30309M	Y30309M	JY10099R	0.5 0.02	56.0 2.20	1.5 0.06	89.0 3.50	2.11 4.64
HM804848	HM804810	HM804810EE	2.3 0.09	57.0 2.26	3.3 0.13	81.0 3.19	1.99 4.42
368A	362A	Y1S-362A	0.3 0.01	56.0 2.20	1.3 0.05	81.0 3.19	1.08 2.34
3975	3920	Y4S-3920	0.5 0.02	61.0 2.40	3.3 0.13	99.0 3.90	3.13 6.91
33895	33821	Y1S-33821	0.3 0.01	60.0 2.36	2.3 0.09	85.0 3.35	1.66 3.66
HM807049	HM807010	HM807010EE	0.3 0.01	63.1 2.48	3.3 0.13	89.0 3.50	2.88 6.35
JLM506849	JLM506810	LM506810EX	0.3 0.01	61.0 2.40	0.5 0.02	82.0 3.23	1.12 2.50
X31311M	Y31311M	JY12021-Q	0.3 0.01	68.0 2.68	2.0 0.08	103.0 4.06	3.27 7.21
28680	28622	Y4S-28622	0.5 0.02	62.0 2.44	0.8 0.03	88.0 3.46	1.57 3.47
387A	382A	Y1S-382A	0.3 0.01	63.0 2.48	0.8 0.03	89.0 3.50	1.24 2.72

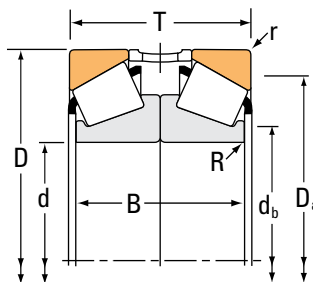
<sup>(5)</sup>Contact your Timken engineer for information on spacer configurations.

<sup>(6)</sup>These maximum fillet radii will be cleared by the bearing corners.

# TAPERED ROLLER BEARINGS

## DOUBLE-ROW • TYPE 2TS-DM

### TYPE 2TS-DM



Bearing Dimensions				Load Ratings							
Bore d	O.D. D	Width <sup>(1)</sup> T	Width B	Dynamic <sup>(2)</sup>		Factors <sup>(3)</sup>		Dynamic <sup>(4)</sup>			Factors <sup>(3)</sup>
				C <sub>1(2)</sub>	e	Y <sub>1</sub>	Y <sub>2</sub>	C <sub>90</sub>	C <sub>a90</sub>	C <sub>90(2)</sub>	K
mm in.	mm in.	mm in.	mm in.	N lbf				N lbf	N lbf	N lbf	
57.150 2.2500	112.712 4.4375	60.325 2.3750	60.096 2.3660	242000 54300	0.40	1.68	2.50	36000 8090	24800 5570	62700 14100	1.45
60.000 2.3622	112.712 4.4375	60.325 2.3750	60.096 2.3660	242000 54300	0.40	1.68	2.50	36000 8090	24800 5570	62700 14100	1.45
60.325 2.3750	100.000 3.9370	50.800 2.0000	50.800 2.0000	185000 41500	0.43	1.59	2.36	27500 6180	20000 4500	47900 10800	1.37
60.325 2.3750	112.712 4.4375	60.325 2.3750	60.096 2.3660	242000 54300	0.40	1.68	2.50	36000 8090	24800 5570	62700 14100	1.45
60.325 2.3750	130.175 5.1250	73.025 2.8750	66.676 2.6250	344000 77400	0.82	0.82	1.23	51200 11500	71900 16200	89200 20100	0.71
61.912 2.4375	123.825 4.8750	76.200 3.0000	73.356 2.8880	332000 74700	0.35	1.95	2.90	49400 11100	29300 6590	86100 19400	1.69
61.912 2.4375	146.050 5.7500	82.550 3.2500	79.376 3.1250	474000 107000	0.78	0.86	1.28	70700 15900	94700 21300	123000 27700	0.75
61.912 2.4375	152.400 6.0000	95.250 3.7500	92.076 3.6250	497000 112000	0.66	1.03	1.53	74000 16600	83100 18700	129000 29000	0.89
63.500 2.5000	112.712 4.4375	60.325 2.3750	60.096 2.3660	242000 54300	0.40	1.68	2.50	36000 8090	24800 5570	62700 14100	1.45
63.500 2.5000	122.238 4.8125	76.200 3.0000	76.708 3.0200	465000 104000	0.34	2.00	2.98	69200 15600	40000 8990	121000 27100	1.73
63.500 2.5000	140.030 5.5130	73.025 2.8750	66.472 2.6170	353000 79300	0.87	0.78	1.16	52600 11800	77900 17500	91500 20600	0.67
65.000 2.5591	105.000 4.1339	48.000 1.8898	46.000 1.8110	223000 50200	0.45	1.49	2.21	33200 7470	25800 5810	57900 13000	1.29
65.000 2.5591	110.000 4.3307	56.000 2.2047	56.000 2.2048	291000 65400	0.40	1.68	2.50	43300 9740	29800 6700	75400 17000	1.45
65.087 2.5625	135.755 5.3447	107.950 4.2500	112.014 4.4100	663000 149000	0.32	2.08	3.10	98800 22200	54900 12300	172000 38700	1.80
66.675 2.6250	112.712 4.4375	60.325 2.3750	60.324 2.3750	291000 65300	0.34	1.99	2.96	43300 9730	25100 5650	75400 16900	1.72
66.675 2.6250	122.238 4.8125	76.200 3.0000	76.708 3.0200	465000 104000	0.34	2.00	2.98	69200 15600	40000 8990	121000 27100	1.73
66.675 2.6250	177.800 7.0000	114.300 4.5000	107.950 4.2500	785000 176000	0.80	0.85	1.26	117000 26300	160000 35900	203000 45700	0.73

<sup>(1)</sup>Overall width can vary depending on spacer selection. Contact your Timken engineer for more information.

<sup>(2)</sup>Based on  $1 \times 10^6$  revolutions  $L_{10}$  life, for the ISO life-calculation method.  $C_{1(2)}$  is the double-row radial value.

<sup>(3)</sup>Consult your Timken engineer for instructions on use or review the Timken Engineering Manual on [timken.com/catalogs](http://timken.com/catalogs).

<sup>(4)</sup>Based on  $90 \times 10^6$  revolutions  $L_{10}$  life, for The Timken Company life-calculation method.  $C_{90}$  and  $C_{a90}$  are radial and thrust values.  $C_{90(2)}$  is the double-row radial value.

Part Number			Dimensions				Bearing Weight
Inner	Outer	Outer Spacer <sup>(5)</sup>	Shaft		Housing		
			Max. Shaft Fillet Radius R <sup>(6)</sup>	Backing Shoulder Dia. d <sub>b</sub>	Max. Housing Fillet Radius r <sup>(6)</sup>	Max. Backing Shoulder Dia. D <sub>a</sub>	
			mm in.	mm in.	mm in.	mm in.	kg lbs.
3979	3920	Y4S-3920	0.5 0.02	66.0 2.60	3.3 0.13	99.0 3.90	2.87 6.35
3977	3920	Y4S-3920	0.5 0.02	68.0 2.68	3.3 0.13	99.0 3.90	2.75 6.07
28985	28921	Y1S-28921	0.3 0.01	67.0 2.64	3.3 0.13	89.0 3.50	1.55 3.45
3980	3920	Y3S-3920	0.5 0.02	68.0 2.68	3.3 0.13	99.0 3.90	2.74 6.06
HM911245	HM911210	HM911210EC	0.8 0.03	74.0 2.91	3.3 0.13	109.0 4.29	4.37 9.65
554	552A	Y3S-552A	0.5 0.02	71.0 2.80	3.3 0.13	109.0 4.29	4.23 9.35
H913842	H913810	H913810EA	0.8 0.03	82.4 3.24	3.3 0.13	124.0 4.88	6.65 14.67
9181	9121	Y1S-9121	0.5 0.02	81.3 3.20	3.3 0.13	130.0 5.12	8.35 18.42
3982	3920	Y3S-3920	0.3 0.01	71.0 2.80	3.3 0.13	99.0 3.90	2.60 5.74
HM212047	HM212011	HM212011EA	0.5 0.02	73.0 2.87	3.3 0.13	108.0 4.25	4.02 8.83
78250	78551	Y2S-78551	0.5 0.02	79.0 3.10	2.3 0.09	117.0 4.61	5.23 11.55
JLM710949C	JLM710910	JY10511-Q	0.3 0.01	72.0 2.83	1.0 0.04	96.0 3.78	1.58 3.45
JM511946	JM511910	JY11011-Q	0.3 0.01	72.0 2.83	2.5 0.10	99.0 3.90	2.19 4.82
6379	6320	Y3S-6320	0.3 0.01	77.0 3.04	3.3 0.13	117.0 4.61	7.50 16.56
39590	39520	Y1S-39520	0.3 0.01	75.0 2.95	3.3 0.13	101.0 3.98	2.41 5.31
HM212049	HM212011	HM212010EA	0.3 0.01	75.5 2.97	3.3 0.13	108.0 4.25	3.88 8.54
HH914449	HH914412	HH914412EA	1.5 0.06	85.3 3.36	3.3 0.13	146.0 5.75	14.54 32.03

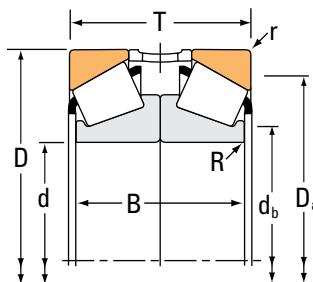
<sup>(5)</sup>Contact your Timken engineer for information on spacer configurations.

<sup>(6)</sup>These maximum fillet radii will be cleared by the bearing corners.

# TAPERED ROLLER BEARINGS

## DOUBLE-ROW • TYPE 2TS-DM

### TYPE 2TS-DM



Bearing Dimensions				Load Ratings							
Bore d	O.D. D	Width <sup>(1)</sup> T	Width B	Dynamic <sup>(2)</sup>				Dynamic <sup>(4)</sup>			
				C <sub>1(2)</sub>	e	Factors <sup>(3)</sup> Y <sub>1</sub>	Y <sub>2</sub>	C <sub>90</sub>	C <sub>a90</sub>	C <sub>90(2)</sub>	Factors <sup>(3)</sup> K
mm in.	mm in.	mm in.	mm in.	N lbf				N lbf	N lbf	N lbf	
68.262 2.6875	161.925 6.3750	98.425 3.8750	92.076 3.6250	614000 138000	0.71	0.95	1.42	91400 20600	111000 24900	159000 35800	0.82
69.850 2.7500	120.000 4.7244	65.090 2.5626	65.090 2.5626	311000 70000	0.36	1.87	2.79	46300 10400	28600 6420	80700 18100	1.62
69.850 2.7500	127.000 5.0000	73.025 2.8750	73.024 2.8750	399000 89700	0.50	1.34	2.00	59400 13400	51100 11500	103000 23300	1.16
69.850 2.7500	146.050 5.7500	82.550 3.2500	79.376 3.1250	474000 107000	0.78	0.86	1.28	70700 15900	94700 21300	123000 27700	0.75
69.850 2.7500	146.050 5.7500	82.550 3.2500	82.550 3.2500	430000 96700	0.41	1.65	2.46	64000 14400	44800 10100	112000 25100	1.43
69.987 2.7554	136.525 5.3750	92.076 3.6250	92.076 3.6250	556000 125000	0.47	1.43	2.12	82700 18600	67000 15100	144000 32400	1.24
71.437 2.8125	136.525 5.3750	82.550 3.2500	82.550 3.2500	562000 126000	0.36	1.87	2.79	83700 18800	51600 11600	146000 32800	1.62
73.025 2.8750	117.475 4.6250	60.325 2.3750	60.324 2.3750	241000 54200	0.44	1.55	2.31	35900 8060	26800 6020	62400 14000	1.34
75.000 2.9528	115.000 4.5276	50.000 1.9686	50.000 1.9686	244000 54900	0.46	1.47	2.19	36400 8180	28600 6420	63400 14200	1.27
75.000 2.9528	125.000 4.9213	74.000 2.9134	74.000 2.9134	356000 80000	0.40	1.70	2.53	53000 11900	36100 8110	92300 20800	1.47
76.200 3.0000	121.442 4.7812	49.215 1.9376	46.024 1.8120	178000 40000	0.45	1.50	2.23	26500 5960	20500 4600	46100 10400	1.30
76.200 3.0000	127.000 5.0000	60.325 2.3750	62.000 2.4410	280000 63100	0.42	1.61	2.40	41800 9390	29900 6730	72700 16300	1.39
76.200 3.0000	135.733 5.3438	88.900 3.5000	92.200 3.6300	527000 118000	0.41	1.66	2.47	78500 17600	54600 12300	137000 30700	1.44
76.200 3.0000	136.525 5.3750	60.325 2.3750	59.538 2.3440	269000 60500	0.44	1.52	2.26	40000 9000	30500 6850	69700 15700	1.31
76.200 3.0000	139.992 5.5115	73.025 2.8750	72.196 2.8424	360000 80900	0.40	1.67	2.49	53600 12100	37100 8330	93400 21000	1.45
76.200 3.0000	146.050 5.7500	82.550 3.2500	82.550 3.2500	430000 96700	0.41	1.65	2.46	64000 14400	44800 10100	112000 25100	1.43
76.200 3.0000	152.400 6.0000	79.375 3.1250	72.644 2.8600	376000 84600	0.44	1.53	2.27	56000 12600	42400 9530	97500 21900	1.32

<sup>(1)</sup>Overall width can vary depending on spacer selection. Contact your Timken engineer for more information.

<sup>(2)</sup>Based on  $1 \times 10^6$  revolutions  $L_{10}$  life, for the ISO life-calculation method.  $C_{1(2)}$  is the double-row radial value.

<sup>(3)</sup>Consult your Timken engineer for instructions on use or review the Timken Engineering Manual on [timken.com/catalogs](http://timken.com/catalogs).

<sup>(4)</sup>Based on  $90 \times 10^6$  revolutions  $L_{10}$  life, for The Timken Company life-calculation method.  $C_{90}$  and  $C_{a90}$  are radial and thrust values.  $C_{90(2)}$  is the double-row radial value.



Part Number			Dimensions				Bearing Weight
Inner	Outer	Outer Spacer <sup>(5)</sup>	Shaft		Housing		
			Max. Shaft Fillet Radius R <sup>(6)</sup>	Backing Shoulder Dia. d <sub>b</sub>	Max. Housing Fillet Radius r <sup>(6)</sup>	Max. Backing Shoulder Dia. D <sub>a</sub>	
			mm in.	mm in.	mm in.	mm in.	kg lbs.
9278	9220	Y1S-9220	0.5 0.02	89.0 3.50	3.3 0.13	138.0 5.43	9.34 20.59
47487	47420	Y1S-47420	0.5 0.02	78.0 3.07	3.3 0.13	107.0 4.21	3.03 6.66
HM813846	HM813810	HM813810EB	0.3 0.01	82.0 3.23	3.3 0.13	111.0 4.37	3.98 8.78
H913849	H913810	H913810EA	0.8 0.03	82.4 3.24	3.3 0.13	124.0 4.88	6.13 13.54
655	653	Y1S-653	0.5 0.02	82.0 3.23	3.3 0.13	131.0 5.16	6.67 14.70
H715347	H715311	H715311EE	0.5 0.02	87.0 3.43	3.3 0.13	118.0 4.65	6.48 14.29
H414249	H414210	H414210EA	1.5 0.06	83.3 3.27	3.3 0.13	121.0 4.76	5.26 11.63
33287	33462	Y5S-33462	0.3 0.01	81.0 3.19	3.3 0.13	104.0 4.09	2.47 5.43
JLM714149	JLM714110	M612910EA	0.3 0.01	82.0 3.23	2.5 0.10	104.0 4.09	1.84 4.05
X33115	Y33115	K161389	0.3 0.01	83.0 3.27	1.5 0.06	112.0 4.41	3.61 7.94
34301	34478	Y4S-34478	0.5 0.02	83.0 3.27	2.0 0.08	110.0 4.33	2.02 4.47
42687	42620	Y3S-42620	0.5 0.02	84.0 3.31	3.3 0.13	114.0 4.49	2.99 6.60
5760	5735	Y2S-5735	0.5 0.02	88.0 3.46	3.3 0.13	119.0 4.69	5.55 12.23
495A	493	Y3S-493	0.5 0.02	86.0 3.39	3.3 0.13	122.0 4.80	3.84 8.43
575	572	Y4S-572	0.5 0.02	86.0 3.39	3.3 0.13	125.0 4.92	4.94 10.93
659	653	Y1S-653	0.5 0.02	87.0 3.43	3.3 0.13	131.0 5.16	6.21 13.66
590A	592A	Y4S-592A	0.5 0.02	89.0 3.50	3.3 0.13	135.0 5.31	6.75 14.88

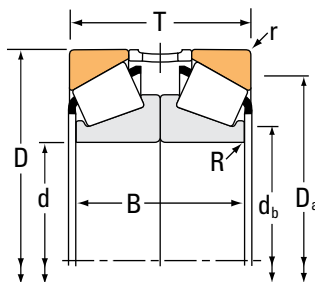
<sup>(5)</sup>Contact your Timken engineer for information on spacer configurations.

<sup>(6)</sup>These maximum fillet radii will be cleared by the bearing corners.

# TAPERED ROLLER BEARINGS

## DOUBLE-ROW • TYPE 2TS-DM

### TYPE 2TS-DM



Bearing Dimensions				Load Ratings							
Bore d	O.D. D	Width <sup>(1)</sup> T	Width B	Dynamic <sup>(2)</sup>				Dynamic <sup>(4)</sup>			
				C <sub>1(2)</sub>	e	Factors <sup>(3)</sup> Y <sub>1</sub>	Y <sub>2</sub>	C <sub>90</sub>	C <sub>a90</sub>	C <sub>90(2)</sub>	Factors <sup>(3)</sup> K
mm in.	mm in.	mm in.	mm in.	N lbf				N lbf	N lbf	N lbf	
76.200 3.0000	161.925 6.3750	95.250 3.7500	96.520 3.8000	570000 128000	0.34	1.98	2.95	84800 19100	49500 11100	148000 33200	1.71
76.200 3.0000	161.925 6.3750	98.425 3.8750	92.076 3.6250	614000 138000	0.71	0.95	1.42	91400 20600	111000 24900	159000 35800	0.82
76.200 3.0000	171.450 6.7500	98.425 3.8750	92.076 3.6250	632000 142000	0.76	0.88	1.31	94100 21200	123000 27700	164000 36800	0.76
77.788 3.0625	117.475 4.6250	50.800 2.0000	50.800 2.0000	205000 46100	0.51	1.32	1.97	30600 6870	26700 5990	53200 12000	1.15
80.000 3.1496	130.000 5.1181	70.000 2.7559	68.000 2.6772	410000 92100	0.39	1.74	2.59	61000 13700	40600 9120	106000 23900	1.50
80.962 3.1875	136.525 5.3750	60.325 2.3750	59.538 2.3440	269000 60500	0.44	1.52	2.26	40000 9000	30500 6850	69700 15700	1.31
82.550 3.2500	133.350 5.2500	79.375 3.1250	79.376 3.1250	450000 101000	0.40	1.68	2.50	67100 15100	46200 10400	117000 26300	1.45
82.550 3.2500	161.925 6.3750	107.950 4.2500	110.200 4.3386	765000 172000	0.40	1.69	2.51	114000 25600	78100 17600	198000 44600	1.46
83.345 3.2813	125.412 4.9375	50.800 2.0000	50.800 2.0000	204000 45900	0.42	1.62	2.42	30400 6830	21600 4860	52900 11900	1.40
84.138 3.3125	171.450 6.7500	98.425 3.8750	92.076 3.6250	632000 142000	0.76	0.88	1.31	94100 21200	123000 27700	164000 36800	0.76
85.000 3.3465	130.000 5.1181	60.000 2.3622	58.000 2.2834	281000 63100	0.44	1.52	2.26	41800 9400	31800 7150	72800 16400	1.31
85.000 3.3465	150.000 5.9055	92.000 3.6220	92.000 3.6220	685000 154000	0.33	2.03	3.02	102000 22900	58100 13100	178000 39900	1.76
88.900 3.5000	161.925 6.3750	107.950 4.2500	110.200 4.3386	765000 172000	0.40	1.69	2.51	114000 25600	78100 17600	198000 44600	1.46
88.900 3.5000	200.000 7.8740	105.522 4.1544	98.424 3.8750	839000 189000	0.63	1.07	1.59	125000 28100	135000 30400	217000 48900	0.92
89.975 3.5423	146.975 5.7864	80.000 3.1496	80.000 3.1496	565000 127000	0.33	2.03	3.02	84200 18900	47900 10800	147000 33000	1.76
90.000 3.5433	140.000 5.5118	64.000 2.5197	64.000 2.5196	378000 85000	0.42	1.60	2.38	56300 12700	40800 9170	98000 22000	1.38
90.000 3.5433	145.000 5.7087	70.000 2.7559	68.000 2.6772	387000 87000	0.44	1.52	2.26	57700 13000	43900 9860	100000 22600	1.31

<sup>(1)</sup>Overall width can vary depending on spacer selection. Contact your Timken engineer for more information.

<sup>(2)</sup>Based on  $1 \times 10^6$  revolutions  $L_{10}$  life, for the ISO life-calculation method.  $C_{1(2)}$  is the double-row radial value.

<sup>(3)</sup>Consult your Timken engineer for instructions on use or review the Timken Engineering Manual on [timken.com/catalogs](http://timken.com/catalogs).

<sup>(4)</sup>Based on  $90 \times 10^6$  revolutions  $L_{10}$  life, for The Timken Company life-calculation method.  $C_{90}$  and  $C_{a90}$  are radial and thrust values.  $C_{90(2)}$  is the double-row radial value.

Part Number			Dimensions				Bearing Weight
Inner	Outer	Outer Spacer <sup>(5)</sup>	Shaft		Housing		
			Max. Shaft Fillet Radius R <sup>(6)</sup>	Backing Shoulder Dia. d <sub>b</sub>	Max. Housing Fillet Radius r <sup>(6)</sup>	Max. Backing Shoulder Dia. D <sub>a</sub>	
			mm in.	mm in.	mm in.	mm in.	kg lbs.
755	752	Y8S-752	0.5 0.02	92.0 3.62	3.3 0.13	144.0 5.67	9.92 21.86
9285	9220	Y1S-9220	0.5 0.02	89.0 3.50	3.3 0.13	138.0 5.43	8.68 19.16
9380	9321	Y1S-9321	0.5 0.02	98.2 3.87	3.3 0.13	147.0 5.79	10.71 23.59
LM814849	LM814810	LM814810EA	0.3 0.01	85.0 3.35	3.3 0.13	105.0 4.13	1.90 4.16
JM515649	JM515610	JY13013-Q	0.3 0.01	88.0 3.46	2.5 0.10	117.0 4.61	3.52 7.78
496	493	Y4S-493	0.5 0.02	89.0 3.50	3.3 0.13	122.0 4.80	3.50 7.69
HM516449C	HM516410	HM516410EA	0.3 0.01	92.0 3.62	3.3 0.13	118.0 4.65	4.41 9.74
6559C	6536	Y2S-6535	0.5 0.02	98.0 3.86	0.8 0.03	144.0 5.67	10.45 23.07
27690	27620	Y2S-27620	0.3 0.01	89.0 3.50	1.5 0.06	115.0 4.53	2.21 4.83
9386H	9321	Y9S-9321	0.5 0.02	98.3 3.87	3.3 0.13	147.0 5.79	9.83 21.66
JM716649	JM716610	M716610EB	0.3 0.01	92.0 3.62	2.5 0.10	117.0 4.61	2.80 6.19
JH217249	JH217210	H217210EA	0.5 0.02	95.0 3.74	2.5 0.10	134.0 5.28	6.90 15.20
6580	6535	Y2S-6535	0.5 0.02	102.0 4.02	3.3 0.13	141.0 5.55	9.71 21.42
98350	98788	Y3S-98788	0.8 0.03	112.0 4.41	3.3 0.13	174.0 6.85	16.18 35.66
HM218248	HM218210	HM218210EA	0.3 0.01	99.0 3.90	3.5 0.14	133.0 5.24	5.19 11.44
X32018X	Y32018X	JY14016-Q	0.3 0.01	98.0 3.86	1.5 0.06	128.0 5.04	3.54 7.79
JM718149	JM718110	JY14516-S	0.8 0.03	99.0 3.90	2.5 0.10	131.0 5.16	4.46 9.82

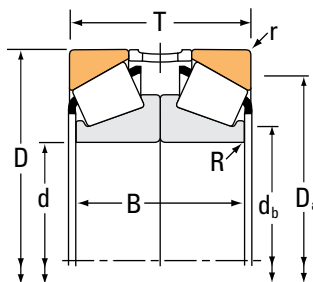
<sup>(5)</sup>Contact your Timken engineer for information on spacer configurations.

<sup>(6)</sup>These maximum fillet radii will be cleared by the bearing corners.

# TAPERED ROLLER BEARINGS

## DOUBLE-ROW • TYPE 2TS-DM

### TYPE 2TS-DM



Bearing Dimensions				Load Ratings							
Bore d	O.D. D	Width <sup>(1)</sup> T	Width B	Dynamic <sup>(2)</sup>				Dynamic <sup>(4)</sup>			
				C <sub>1(2)</sub>	e	Factors <sup>(3)</sup> Y <sub>1</sub>	Y <sub>2</sub>	C <sub>90</sub>	C <sub>a90</sub>	C <sub>90(2)</sub>	Factors <sup>(3)</sup> K
mm in.	mm in.	mm in.	mm in.	N lbf				N lbf	N lbf	N lbf	
90.000 3.5433	155.000 6.1024	88.000 3.4646	88.000 3.4646	683000 153000	0.34	1.98	2.95	102000 22900	59400 13300	177000 39800	1.71
90.000 3.5433	190.000 7.4803	101.600 4.0000	92.076 3.6250	667000 150000	0.87	0.78	1.16	99300 22300	147000 33100	173000 38900	0.67
95.000 3.7402	150.000 5.9055	70.000 2.7559	68.000 2.6772	374000 84000	0.44	1.53	2.27	55700 12500	42100 9470	96900 21800	1.32
95.250 3.7500	147.638 5.8125	71.435 2.8124	72.644 2.8600	376000 84600	0.44	1.53	2.27	56000 12600	42400 9530	97500 21900	1.32
95.250 3.7500	168.275 6.6250	82.550 3.2500	82.550 3.2500	461000 104000	0.47	1.43	2.14	68600 15400	55300 12400	119000 26900	1.24
96.838 3.8125	148.430 5.8437	57.150 2.2500	57.942 2.2812	336000 75600	0.49	1.37	2.04	50100 11300	42200 9480	87100 19600	1.19
96.838 3.8125	188.912 7.4375	101.600 4.0000	92.076 3.6250	667000 150000	0.87	0.78	1.16	99300 22300	147000 33100	173000 38900	0.67
98.425 3.8750	168.275 6.6250	82.550 3.2500	82.550 3.2500	461000 104000	0.47	1.43	2.14	68600 15400	55300 12400	119000 26900	1.24
98.425 3.8750	184.150 7.2500	127.000 5.0000	127.000 5.0000	1090000 246000	0.37	1.80	2.69	163000 36600	104000 23500	284000 63800	1.56
99.212 3.9060	171.450 6.7500	98.425 3.8750	98.424 3.8750	602000 135000	0.34	1.97	2.93	89600 20100	52600 11800	156000 35100	1.70
100.000 3.9370	155.000 6.1024	72.000 2.8346	70.000 2.7560	403000 90600	0.47	1.43	2.12	60000 13500	48600 10900	104000 23500	1.24
100.000 3.9370	155.000 6.1024	72.481 2.8536	70.000 2.7560	403000 90600	0.47	1.43	2.12	60000 13500	48600 10900	104000 23500	1.24
100.000 3.9370	160.000 6.2992	82.000 3.2284	80.000 3.1496	576000 130000	0.47	1.43	2.14	85800 19300	69100 15500	149000 33600	1.24
100.000 3.9370	180.000 7.0866	74.000 2.9134	68.000 2.6772	524000 118000	0.42	1.61	2.39	78000 17500	56100 12600	136000 30500	1.39
101.600 4.0000	168.275 6.6250	82.550 3.2500	82.550 3.2500	461000 104000	0.47	1.43	2.14	68600 15400	55300 12400	119000 26900	1.24
101.600 4.0000	212.725 8.3750	133.350 5.2500	133.350 5.2500	996000 224000	0.33	2.07	3.09	148000 33300	82700 18600	258000 58000	1.79
101.600 4.0000	250.825 9.8750	152.400 6.0000	146.050 5.7500	1440000 324000	0.70	0.97	1.44	215000 48200	257000 57800	374000 84000	0.84

<sup>(1)</sup>Overall width can vary depending on spacer selection. Contact your Timken engineer for more information.

<sup>(2)</sup>Based on  $1 \times 10^6$  revolutions  $L_{10}$  life, for the ISO life-calculation method.  $C_{1(2)}$  is the double-row radial value.

<sup>(3)</sup>Consult your Timken engineer for instructions on use or review the Timken Engineering Manual on [timken.com/catalogs](http://timken.com/catalogs).

<sup>(4)</sup>Based on  $90 \times 10^6$  revolutions  $L_{10}$  life, for The Timken Company life-calculation method.  $C_{90}$  and  $C_{a90}$  are radial and thrust values.  $C_{90(2)}$  is the double-row radial value.

Part Number			Dimensions				Bearing Weight
Inner	Outer	Outer Spacer <sup>(5)</sup>	Shaft		Housing		
			Max. Shaft Fillet Radius	Backing Shoulder Dia.	Max. Housing Fillet Radius	Max. Backing Shoulder Dia.	
			R <sup>(6)</sup>	d <sub>b</sub>	r <sup>(6)</sup>	D <sub>a</sub>	
			mm in.	mm in.	mm in.	mm in.	kg lbs.
JHM318448	JHM318410	HM318410EA	0.5 0.02	100.0 3.94	2.5 0.10	140.0 5.51	6.84 15.04
J90354	J90748	Y1S-90748	1.5 0.06	111.8 4.40	3.3 0.13	162.0 6.38	12.61 27.82
JM719149	JM719113	H217210EA	0.3 0.01	104.0 4.09	2.5 0.10	135.0 5.31	4.51 9.97
594	592XS	Y1S-592XS	0.3 0.01	104.0 4.09	3.3 0.13	133.0 5.24	4.31 9.51
683	672	Y6S-672	0.5 0.02	106.0 4.17	3.3 0.13	149.0 5.87	7.81 17.21
42381	42584	Y3S-42584	0.3 0.01	105.0 4.13	3.0 0.12	134.0 5.28	3.53 7.80
90381	90744	Y2S-90744	1.5 0.06	113.0 4.44	3.3 0.13	161.0 6.34	11.77 25.95
685	672	Y13S-672	0.5 0.02	109.0 4.29	3.3 0.13	149.0 5.87	7.58 16.67
HH421246C	HH421210	HH421210EB	1.5 0.06	115.1 4.53	3.3 0.13	163.0 6.42	15.24 33.63
HM321245	HM321210	HM321210EB	0.5 0.02	109.0 4.29	3.3 0.13	155.0 6.10	9.22 20.33
JM720249	JM720210	JY15516-Q	0.3 0.01	109.0 4.29	2.5 0.10	140.0 5.51	4.89 10.76
JM720249	JM720210	M720210EB	0.3 0.01	109.0 4.29	2.5 0.10	140.0 5.51	4.90 10.80
JHM720249	JHM720210	JY16018R	0.3 0.01	109.4 4.30	2.5 0.10	143.0 5.63	6.25 13.78
X30220M	Y30220M	JY18016-Q	1.0 0.04	115.0 4.53	2.5 0.10	163.0 6.42	7.87 17.35
687	672	Y6S-672	0.5 0.02	112.0 4.41	3.3 0.13	149.0 5.87	7.17 15.81
941	932	Y1S-932	0.8 0.03	117.0 4.61	3.3 0.13	187.0 7.36	22.69 50.05
HH923649	HH923610	HH923610EA	1.5 0.06	130.8 5.15	6.4 0.25	207.0 8.15	36.33 80.12

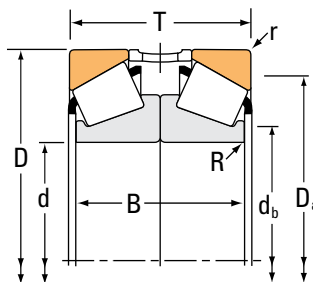
<sup>(5)</sup>Contact your Timken engineer for information on spacer configurations.

<sup>(6)</sup>These maximum fillet radii will be cleared by the bearing corners.

# TAPERED ROLLER BEARINGS

## DOUBLE-ROW • TYPE 2TS-DM

### TYPE 2TS-DM



Bearing Dimensions				Load Ratings							
Bore d	O.D. D	Width <sup>(1)</sup> T	Width B	Dynamic <sup>(2)</sup>				Dynamic <sup>(4)</sup>			
				C <sub>1(2)</sub>	e	Factors <sup>(3)</sup> Y <sub>1</sub>	Y <sub>2</sub>	C <sub>90</sub>	C <sub>a90</sub>	C <sub>90(2)</sub>	Factors <sup>(3)</sup> K
mm in.	mm in.	mm in.	mm in.	N lbf				N lbf	N lbf	N lbf	
106.362 4.1875	165.100 6.5000	73.025 2.8750	73.024 2.8750	394000 88600	0.50	1.36	2.02	58700 13200	50000 11200	102000 23000	1.18
107.950 4.2500	158.750 6.2500	46.040 1.8126	42.876 1.6880	238000 53400	0.61	1.11	1.66	35400 7960	36700 8250	61600 13900	0.96
107.950 4.2500	212.725 8.3750	133.350 5.2500	133.350 5.2500	1180000 266000	0.33	2.07	3.09	176000 39600	98300 22100	307000 69000	1.79
107.950 4.2500	212.725 8.3750	133.350 5.2500	133.350 5.2500	996000 224000	0.33	2.07	3.09	148000 33300	82700 18600	258000 58000	1.79
110.000 4.3307	165.000 6.4961	70.000 2.7560	70.000 2.7560	396000 88900	0.50	1.36	2.02	58900 13200	50100 11300	103000 23100	1.18
110.000 4.3307	200.000 7.8740	112.000 4.4095	106.000 4.1732	858000 193000	0.42	1.61	2.39	128000 28700	91900 20700	222000 50000	1.39
110.000 4.3307	240.000 9.4488	126.000 4.9606	114.000 4.4882	963000 217000	0.83	0.82	1.22	143000 32200	203000 45500	250000 56100	0.71
111.125 4.3750	214.312 8.4375	111.125 4.3750	104.776 4.1250	970000 218000	0.67	1.00	1.49	144000 32500	167000 37500	251000 56500	0.87
114.300 4.5000	177.800 7.0000	82.550 3.2500	82.550 3.2500	478000 108000	0.52	1.31	1.95	71200 16000	62900 14100	124000 27900	1.13
114.300 4.5000	212.725 8.3750	133.350 5.2500	133.350 5.2500	996000 224000	0.33	2.07	3.09	148000 33300	82700 18600	258000 58000	1.79
114.300 4.5000	228.600 9.0000	107.950 4.2500	98.856 3.8920	1020000 230000	0.74	0.92	1.36	152000 34200	192000 43100	265000 59500	0.79
114.300 4.5000	279.400 11.0000	165.100 6.5000	165.100 6.5000	1850000 417000	0.63	1.07	1.59	276000 62100	299000 67200	481000 108000	0.92
120.650 4.7500	199.975 7.8730	92.075 3.6250	92.075 3.6250	629000 142000	0.43	1.58	2.35	93700 21100	68500 15400	163000 36700	1.37
120.650 4.7500	206.375 8.1250	95.250 3.7500	95.250 3.7500	658000 148000	0.46	1.47	2.19	98000 22000	77000 17300	171000 38400	1.27
120.650 4.7500	234.950 9.2500	127.000 5.0000	127.000 5.0000	1090000 246000	0.37	1.83	2.72	163000 36700	103000 23200	284000 63800	1.58
120.650 4.7500	254.000 10.0000	155.575 6.1250	165.100 6.5000	1580000 356000	0.32	2.10	3.13	236000 53000	130000 29200	411000 92400	1.82
120.650 4.7500	273.050 10.7500	165.100 6.5000	165.100 6.5000	1850000 417000	0.63	1.07	1.59	276000 62100	299000 67200	481000 108000	0.92

<sup>(1)</sup>Overall width can vary depending on spacer selection. Contact your Timken engineer for more information.

<sup>(2)</sup>Based on  $1 \times 10^6$  revolutions  $L_{10}$  life, for the ISO life-calculation method.  $C_{1(2)}$  is the double-row radial value.

<sup>(3)</sup>Consult your Timken engineer for instructions on use or review the Timken Engineering Manual on [timken.com/catalogs](http://timken.com/catalogs).

<sup>(4)</sup>Based on  $90 \times 10^6$  revolutions  $L_{10}$  life, for The Timken Company life-calculation method.  $C_{90}$  and  $C_{a90}$  are radial and thrust values.  $C_{90(2)}$  is the double-row radial value.

Part Number			Dimensions				Bearing Weight
Inner	Outer	Outer Spacer <sup>(5)</sup>	Shaft		Housing		
			Max. Shaft Fillet Radius R <sup>(6)</sup>	Backing Shoulder Dia. d <sub>b</sub>	Max. Housing Fillet Radius r <sup>(6)</sup>	Max. Backing Shoulder Dia. D <sub>a</sub>	
			mm in.	mm in.	mm in.	mm in.	kg lbs.
56418	56650	Y2S-56650	0.5 0.02	116.0 4.57	3.3 0.13	149.0 5.87	5.64 12.42
K37425	K37625	K161710	0.5 0.02	115.0 4.53	3.3 0.13	143.0 5.63	2.92 6.41
HH224340	HH224310	HH224310EC	1.5 0.06	126.0 4.96	3.3 0.13	192.0 7.56	21.35 47.08
936	932	Y1S-932	0.8 0.03	122.0 4.80	3.3 0.13	187.0 7.36	21.57 47.56
JM822049	JM822010	M822010EA	0.3 0.01	119.0 4.69	2.5 0.10	149.0 5.87	5.05 11.17
X32222M	Y32222M	JY20020-Q	1.0 0.04	125.0 4.92	2.5 0.10	179.0 7.05	14.57 32.12
X31322M	Y31322M	JY24050-Q	1.8 0.07	135.0 5.35	3.0 0.12	206.0 8.11	13.82 30.46
H924045	H924010	H924010EA	1.5 0.06	131.2 5.16	3.3 0.13	186.0 7.32	17.33 38.21
64450	64700	Y2S-64700	0.5 0.02	125.0 4.92	3.3 0.13	160.0 6.30	7.18 15.85
938	932	Y6S-932	0.8 0.03	128.0 5.04	3.3 0.13	187.0 7.36	20.79 45.85
HM926740	HM926710	HM926710EE	2.0 0.08	142.0 5.59	3.3 0.13	200.0 7.87	19.77 43.59
HH926744	HH926716	HH926716EC	1.5 0.06	147.2 5.80	6.4 0.25	233.0 9.17	49.76 109.68
HM624749	HM624716	HM624716EA	0.5 0.02	132.0 5.20	1.5 0.06	178.0 7.01	11.50 25.36
795	792	Y3S-792	0.8 0.03	134.0 5.28	3.3 0.13	186.0 7.32	13.32 29.38
95475	95925	Y1S-95925	0.8 0.03	137.0 5.39	3.3 0.13	209.0 8.23	25.89 57.11
HH228340	HH228310	HH228310EA	1.5 0.06	142.0 5.59	6.4 0.25	223.0 8.78	38.54 84.97
HH926749	HH926710	HH926710EB	1.5 0.06	147.2 5.80	6.4 0.25	230.0 9.06	45.20 99.61

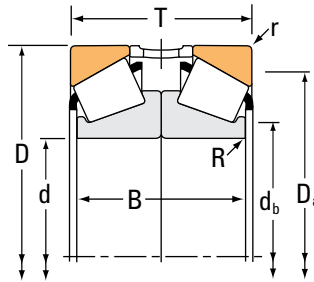
<sup>(5)</sup>Contact your Timken engineer for information on spacer configurations.

<sup>(6)</sup>These maximum fillet radii will be cleared by the bearing corners.

# TAPERED ROLLER BEARINGS

## DOUBLE-ROW • TYPE 2TS-DM

### TYPE 2TS-DM



Bearing Dimensions				Load Ratings							
Bore d	O.D. D	Width <sup>(1)</sup> T	Width B	Dynamic <sup>(2)</sup>				Dynamic <sup>(4)</sup>			
				C <sub>1(2)</sub>	e	Factors <sup>(3)</sup> Y <sub>1</sub>	Y <sub>2</sub>	C <sub>90</sub>	C <sub>a90</sub>	C <sub>90(2)</sub>	Factors <sup>(3)</sup> K
mm in.	mm in.	mm in.	mm in.	N lbf				N lbf	N lbf	N lbf	
125.298 4.9330	228.600 9.0000	107.950 4.2500	98.857 3.8920	1020000 230000	0.74	0.92	1.36	152000 34200	192000 43100	265000 59500	0.79
127.000 5.0000	182.562 7.1875	79.375 3.1250	76.200 3.0000	466000 105000	0.31	2.21	3.29	69400 15600	36300 8160	121000 27200	1.91
127.000 5.0000	196.850 7.7500	92.075 3.6250	92.075 3.6250	640000 144000	0.34	1.96	2.92	95300 21400	56100 12600	166000 37300	1.70
127.000 5.0000	214.975 8.4636	95.250 3.7500	95.250 3.7500	665000 150000	0.49	1.38	2.06	99000 22300	82600 18600	172000 38800	1.20
127.000 5.0000	215.900 8.5000	95.250 3.7500	95.250 3.7500	665000 150000	0.49	1.38	2.06	99000 22300	82600 18600	172000 38800	1.20
127.000 5.0000	228.600 9.0000	107.950 4.2500	98.857 3.8920	1020000 230000	0.74	0.92	1.36	152000 34200	192000 43100	265000 59500	0.79
127.000 5.0000	234.950 9.2500	127.000 5.0000	127.000 5.0000	1090000 246000	0.37	1.83	2.72	163000 36700	103000 23200	284000 63800	1.58
127.000 5.0000	304.800 12.0000	177.800 7.0000	165.100 6.5000	2020000 453000	0.73	0.93	1.38	300000 67500	374000 84100	522000 117000	0.80
127.792 5.0312	228.600 9.0000	107.950 4.2500	98.857 3.8920	1020000 230000	0.74	0.92	1.36	152000 34200	192000 43100	265000 59500	0.79
130.000 5.1181	206.375 8.1250	95.250 3.7500	95.250 3.7500	658000 148000	0.46	1.47	2.19	98000 22000	77000 17300	171000 38400	1.27
130.000 5.1181	230.000 9.0551	135.500 5.3346	128.000 5.0394	1190000 267000	0.44	1.55	2.31	177000 39800	132000 29600	308000 69200	1.34
130.000 5.1181	280.000 11.0236	144.000 5.6693	132.000 5.1969	1200000 270000	0.83	0.82	1.22	179000 40300	253000 56900	312000 70100	0.71
133.350 5.2500	196.850 7.7500	92.075 3.6250	92.075 3.6250	672000 151000	0.34	1.96	2.92	100000 22500	58900 13300	174000 39200	1.70
133.350 5.2500	215.900 8.5000	95.250 3.7500	95.250 3.7500	665000 150000	0.49	1.38	2.06	99000 22300	82600 18600	172000 38800	1.20
139.700 5.5000	180.975 7.1250	42.865 1.6876	41.276 1.6250	197000 44400	0.37	1.85	2.75	29400 6600	18400 4130	51200 11500	1.60
139.700 5.5000	215.900 8.5000	95.250 3.7500	95.250 3.7500	665000 150000	0.49	1.38	2.06	99000 22300	82600 18600	172000 38800	1.20
139.700 5.5000	254.000 10.0000	133.350 5.2500	133.350 5.2500	1150000 258000	0.41	1.66	2.47	171000 38500	119000 26800	298000 67000	1.43

<sup>(1)</sup>Overall width can vary depending on spacer selection. Contact your Timken engineer for more information.

<sup>(2)</sup>Based on  $1 \times 10^6$  revolutions  $L_{10}$  life, for the ISO life-calculation method.  $C_{1(2)}$  is the double-row radial value.

<sup>(3)</sup>Consult your Timken engineer for instructions on use or review the Timken Engineering Manual on [timken.com/catalogs](http://timken.com/catalogs).

<sup>(4)</sup>Based on  $90 \times 10^6$  revolutions  $L_{10}$  life, for The Timken Company life-calculation method.  $C_{90}$  and  $C_{a90}$  are radial and thrust values.  $C_{90(2)}$  is the double-row radial value.



Part Number			Dimensions				Bearing Weight
Inner	Outer	Outer Spacer <sup>(5)</sup>	Shaft		Housing		
			Max. Shaft Fillet Radius R <sup>(6)</sup>	Backing Shoulder Dia. d <sub>b</sub>	Max. Housing Fillet Radius r <sup>(6)</sup>	Max. Backing Shoulder Dia. D <sub>a</sub>	
			mm in.	mm in.	mm in.	mm in.	kg lbs.
HM926745	HM926710	HM926710EE	2.0 0.08	143.0 5.63	3.3 0.13	200.0 7.87	18.17 40.05
48290	48220	Y5S-48220	0.5 0.02	135.0 5.31	3.3 0.13	168.0 6.61	8.02 17.68
67388	67322	Y1S-67322	0.8 0.03	138.0 5.43	3.3 0.13	180.0 7.09	10.39 22.92
74500	74845	K160066	1.0 0.04	141.0 5.55	3.3 0.13	196.0 7.72	14.33 31.60
74500	74850	Y4S-74850	1.0 0.04	141.0 5.55	3.3 0.13	196.0 7.72	14.31 31.54
HM926747	HM926710	HM926710EE	2.0 0.08	143.0 5.63	3.3 0.13	200.0 7.87	17.89 39.47
95500	95925	Y1S-95925	0.8 0.03	142.0 5.59	3.3 0.13	209.0 8.23	24.67 54.39
HH932132	HH932110	HH932110EC	1.5 0.06	172.0 6.77	6.4 0.25	260.0 10.24	61.95 136.57
HM926749	HM926710	HM926710EE	2.0 0.08	143.0 5.63	3.3 0.13	200.0 7.87	17.77 39.20
797	792	Y4S-792	0.8 0.03	141.0 5.55	3.3 0.13	186.0 7.32	13.51 29.80
X32226M	Y32226M	JY23028-Q	1.0 0.04	145.0 5.71	3.0 0.12	206.0 8.11	23.43 51.69
X31326M	Y31326M	JY28056-Q	0.8 0.03	163.0 6.42	4.0 0.16	238.0 9.37	41.08 90.56
M327349	67322	Y1S-67322	0.8 0.03	144.0 5.67	3.3 0.13	180.0 7.09	9.42 20.76
74525	74850	Y4S-74850	0.8 0.03	146.0 5.75	3.3 0.13	196.0 7.72	13.35 29.40
LL428349	LL428310	LL428310EA	0.5 0.02	146.0 5.75	1.5 0.06	172.0 6.77	2.61 5.75
74550	74850	Y4S-74850	0.8 0.03	151.0 5.94	3.3 0.13	196.0 7.72	12.33 27.16
99550	99100	Y1S-99100	4.0 0.16	156.0 6.14	3.3 0.13	227.0 8.94	29.52 65.08

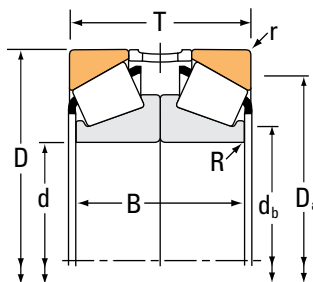
<sup>(5)</sup>Contact your Timken engineer for information on spacer configurations.

<sup>(6)</sup>These maximum fillet radii will be cleared by the bearing corners.

# TAPERED ROLLER BEARINGS

## DOUBLE-ROW • TYPE 2TS-DM

### TYPE 2TS-DM



Bearing Dimensions				Load Ratings							
Bore d	O.D. D	Width <sup>(1)</sup> T	Width B	Dynamic <sup>(2)</sup>				Dynamic <sup>(4)</sup>			
				C <sub>1(2)</sub>	e	Factors <sup>(3)</sup> Y <sub>1</sub>	Y <sub>2</sub>	C <sub>90</sub>	C <sub>a90</sub>	C <sub>90(2)</sub>	Factors <sup>(3)</sup> K
mm in.	mm in.	mm in.	mm in.	N lbf				N lbf	N lbf	N lbf	
146.050 5.7500	268.288 10.5625	149.225 5.8750	149.225 5.8750	1370000 307000	0.39	1.74	2.59	203000 45700	135000 30300	354000 79600	1.51
146.050 5.7500	304.800 12.0000	177.800 7.0000	165.100 6.5000	2020000 453000	0.73	0.93	1.38	300000 67500	374000 84100	522000 117000	0.80
149.225 5.8750	236.538 9.3125	114.300 4.5000	113.284 4.4600	1040000 234000	0.32	2.12	3.15	155000 34800	84500 19000	269000 60600	1.83
150.000 5.9055	320.000 12.5984	164.000 6.4567	150.000 5.9055	1500000 338000	0.83	0.82	1.22	224000 50300	316000 71000	389000 87500	0.71
152.400 6.0000	222.250 8.7500	93.660 3.6874	93.660 3.6874	607000 136000	0.33	2.03	3.02	90400 20300	51500 11600	157000 35400	1.76
152.400 6.0000	254.000 10.0000	133.350 5.2500	133.350 5.2500	1150000 258000	0.41	1.66	2.47	171000 38500	119000 26800	298000 67000	1.43
152.400 6.0000	307.975 12.1250	177.800 7.0000	187.325 7.3750	2010000 451000	0.33	2.07	3.08	299000 67200	167000 37500	520000 117000	1.79
155.575 6.1250	330.200 13.0000	171.450 6.7500	158.750 6.2500	2140000 481000	0.81	0.83	1.24	319000 71600	441000 99200	555000 125000	0.72
158.750 6.2500	225.425 8.8750	82.550 3.2500	79.375 3.1250	528000 119000	0.38	1.76	2.62	78600 17700	51600 11600	137000 30800	1.52
158.750 6.2500	285.750 11.2500	152.400 6.0000	146.050 5.7500	1240000 280000	0.40	1.68	2.50	185000 41700	128000 28700	323000 72500	1.45
161.925 6.3750	374.650 14.7500	174.625 6.8750	158.750 6.2500	2300000 518000	0.71	0.96	1.42	343000 77200	415000 93300	598000 134000	0.83
165.100 6.5000	247.650 9.7500	95.250 3.7500	95.250 3.7500	705000 159000	0.44	1.54	2.29	105000 23600	79000 17800	183000 41100	1.33
165.100 6.5000	288.925 11.3750	127.000 5.0000	127.000 5.0000	1150000 258000	0.47	1.44	2.15	171000 38500	137000 30800	298000 67000	1.25
165.100 6.5000	311.150 12.2500	165.100 6.5000	165.100 6.5000	1840000 414000	0.33	2.04	3.04	274000 61600	155000 34900	477000 107000	1.77
165.100 6.5000	336.550 13.2500	190.500 7.5000	190.500 7.5000	2880000 648000	0.37	1.82	2.71	429000 96500	273000 61400	748000 168000	1.57
168.275 6.6250	247.650 9.7500	95.250 3.7500	95.250 3.7500	705000 159000	0.44	1.54	2.29	105000 23600	79000 17800	183000 41100	1.33
168.275 6.6250	330.200 13.0000	171.450 6.7500	158.750 6.2500	2140000 481000	0.81	0.83	1.24	319000 71600	441000 99200	555000 125000	0.72

<sup>(1)</sup>Overall width can vary depending on spacer selection. Contact your Timken engineer for more information.

<sup>(2)</sup>Based on 1 x 10<sup>6</sup> revolutions L<sub>10</sub> life, for the ISO life-calculation method. C<sub>1(2)</sub> is the double-row radial value.

<sup>(3)</sup>Consult your Timken engineer for instructions on use or review the Timken Engineering Manual on [timken.com/catalogs](http://timken.com/catalogs).

<sup>(4)</sup>Based on 90 x 10<sup>6</sup> revolutions L<sub>10</sub> life, for The Timken Company life-calculation method. C<sub>90</sub> and C<sub>a90</sub> are radial and thrust values. C<sub>90(2)</sub> is the double-row radial value.

Part Number			Dimensions				Bearing Weight
Inner	Outer	Outer Spacer <sup>(5)</sup>	Shaft		Housing		
			Max. Shaft Fillet Radius R <sup>(6)</sup>	Backing Shoulder Dia. d <sub>b</sub>	Max. Housing Fillet Radius r <sup>(6)</sup>	Max. Backing Shoulder Dia. D <sub>a</sub>	
			mm in.	mm in.	mm in.	mm in.	kg lbs.
EE107057	107105	Y2S-107105	1.5 0.06	166.0 6.54	6.4 0.25	237.0 9.33	41.74 91.99
HH932145	HH932110	HH932110EC	1.5 0.06	174.0 6.87	6.4 0.25	260.0 10.24	56.73 125.06
HM231149	HM231110	HM231110EC	1.5 0.06	163.0 6.42	3.3 0.13	217.0 8.54	18.48 40.71
X31330M	Y31330M	JY32064-Q	2.0 0.08	187.0 7.36	4.0 0.16	276.0 10.87	60.19 132.61
M231649	M231610	K75277	0.8 0.03	163.0 6.42	1.5 0.06	207.0 8.15	11.94 26.34
99600	99100	Y1S-99100	4.0 0.16	169.7 6.68	3.3 0.13	227.0 8.94	26.46 58.34
HH234048	HH234010	HH234010EC	3.3 0.13	179.0 7.05	6.8 0.27	276.1 10.87	61.59 135.77
H936340	H936310	H936310EA	1.3 0.05	192.4 7.58	6.4 0.25	282.0 11.10	67.25 148.26
46780	46720	Y2S-46720	0.8 0.03	169.0 6.65	3.3 0.13	209.0 8.23	10.66 23.53
EE217062X	217112	Y2S-217112	1.5 0.06	176.0 6.93	6.4 0.25	251.0 9.88	39.70 87.52
EE117063	117148	Y3S-117148	1.5 0.06	197.0 7.76	1.5 0.06	322.0 12.68	88.58 195.27
67780	67720	Y1S-67720	0.5 0.02	179.0 7.05	3.3 0.13	229.0 9.02	16.43 36.24
94649	94113	Y11S-94113	1.5 0.06	186.0 7.32	3.3 0.13	259.0 10.20	40.61 89.52
H238140	H238110	H238110EA	1.5 0.06	188.0 7.40	6.4 0.25	280.0 11.02	56.92 125.51
HH437549	HH437510	HH437510EA	3.3 0.13	196.0 7.72	6.4 0.25	297.0 11.69	79.69 175.70
67782	67720	Y3S-67720	0.5 0.02	181.0 7.13	3.3 0.13	229.0 9.02	15.71 34.65
H936349	H936310	H936310EA	0.8 0.03	192.4 7.58	6.4 0.25	282.0 11.10	63.23 139.40

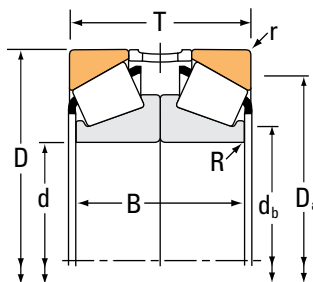
<sup>(5)</sup>Contact your Timken engineer for information on spacer configurations.

<sup>(6)</sup>These maximum fillet radii will be cleared by the bearing corners.

# TAPERED ROLLER BEARINGS

## DOUBLE-ROW • TYPE 2TS-DM

### TYPE 2TS-DM



Bearing Dimensions				Load Ratings							
Bore d	O.D. D	Width <sup>(1)</sup> T	Width B	Dynamic <sup>(2)</sup>				Dynamic <sup>(4)</sup>			
				C <sub>1(2)</sub>	e	Factors <sup>(3)</sup> Y <sub>1</sub>	Y <sub>2</sub>	C <sub>90</sub>	C <sub>a90</sub>	C <sub>90(2)</sub>	Factors <sup>(3)</sup> K
mm in.	mm in.	mm in.	mm in.	N lbf				N lbf	N lbf	N lbf	
169.975 6.6919	260.350 10.2500	133.350 5.2500	133.350 5.2500	1140000 256000	0.40	1.68	2.50	169000 38100	117000 26200	295000 66300	1.45
170.000 6.6929	230.000 9.0551	76.000 2.9921	76.000 2.9922	618000 139000	0.38	1.76	2.62	92000 20700	60400 13600	160000 36000	1.52
170.000 6.6929	230.000 9.0551	78.000 3.0708	76.000 2.9922	583000 131000	0.38	1.76	2.62	86800 19500	56900 12800	151000 34000	1.52
170.000 6.6929	240.000 9.4488	92.000 3.6220	89.000 3.5040	667000 150000	0.44	1.54	2.30	99300 22300	74300 16700	173000 38900	1.34
170.000 6.6929	254.000 10.0000	92.075 3.6250	92.076 3.6250	867000 195000	0.37	1.83	2.72	129000 29000	81600 18300	225000 50500	1.58
170.000 6.6929	260.000 10.2362	114.000 4.4882	114.000 4.4882	1060000 239000	0.44	1.52	2.26	158000 35500	120000 27000	275000 61900	1.31
171.450 6.7500	374.650 14.7500	174.625 6.8750	158.750 6.2500	2300000 518000	0.71	0.96	1.42	343000 77200	415000 93300	598000 134000	0.83
174.625 6.8750	247.650 9.7500	95.250 3.7500	95.250 3.7500	705000 159000	0.44	1.54	2.29	105000 23600	79000 17800	183000 41100	1.33
177.800 7.0000	247.650 9.7500	95.250 3.7500	95.250 3.7500	705000 159000	0.44	1.54	2.29	105000 23600	79000 17800	183000 41100	1.33
177.800 7.0000	279.400 11.0000	123.825 4.8750	123.824 4.8750	930000 209000	0.52	1.29	1.92	138000 31100	124000 28000	241000 54200	1.11
177.800 7.0000	288.925 11.3750	127.000 5.0000	127.000 5.0000	1700000 382000	0.32	2.12	3.15	253000 56900	138000 31100	441000 99100	1.83
177.800 7.0000	355.600 14.0000	158.750 6.2500	155.576 6.1250	1850000 416000	0.55	1.24	1.84	276000 62000	258000 57900	480000 108000	1.07
177.800 7.0000	428.625 16.8750	212.726 8.3750	190.500 7.5000	2620000 588000	0.76	0.89	1.33	390000 87600	506000 114000	679000 153000	0.77
180.000 7.0866	250.000 9.8425	90.000 3.5434	90.000 3.5434	712000 160000	0.48	1.41	2.09	106000 23800	87200 19600	185000 41500	1.22
180.000 7.0866	250.000 9.8425	90.000 3.5434	90.000 3.5434	702000 158000	0.48	1.41	2.09	105000 23500	85900 19300	182000 40900	1.22
180.000 7.0866	280.000 11.0236	128.000 5.0394	128.000 5.0394	1230000 277000	0.42	1.60	2.38	183000 41200	133000 29800	319000 71700	1.38
190.000 7.4803	260.000 10.2362	92.000 3.6220	88.000 3.4646	708000 159000	0.48	1.41	2.11	105000 23700	86200 19400	184000 41300	1.22

<sup>(1)</sup>Overall width can vary depending on spacer selection. Contact your Timken engineer for more information.

<sup>(2)</sup>Based on  $1 \times 10^6$  revolutions  $L_{10}$  life, for the ISO life-calculation method.  $C_{1(2)}$  is the double-row radial value.

<sup>(3)</sup>Consult your Timken engineer for instructions on use or review the Timken Engineering Manual on [timken.com/catalogs](http://timken.com/catalogs).

<sup>(4)</sup>Based on  $90 \times 10^6$  revolutions  $L_{10}$  life, for The Timken Company life-calculation method.  $C_{90}$  and  $C_{a90}$  are radial and thrust values.  $C_{90(2)}$  is the double-row radial value.

Part Number			Dimensions				Bearing Weight
Inner	Outer	Outer Spacer <sup>(5)</sup>	Shaft		Housing		
			Max. Shaft Fillet Radius	Backing Shoulder Dia.	Max. Housing Fillet Radius	Max. Backing Shoulder Dia.	
			R <sup>(6)</sup>	d <sub>b</sub>	r <sup>(6)</sup>	D <sub>a</sub>	
			mm in.	mm in.	mm in.	mm in.	kg lbs.
HM535347	HM535310	HM535310EA	1.5 0.06	186.1 7.40	3.3 0.13	236.0 9.29	25.94 57.22
X32934M	Y32934M	K167396	0.6 0.03	179.0 7.05	2.0 0.08	215.0 8.46	9.14 20.15
JHM534149	JHM534110	HM534110EB	0.5 0.02	178.0 7.01	2.5 0.10	217.0 8.54	8.90 19.59
JM734449A	JM734410	M734410EB	0.5 0.02	180.0 7.09	2.5 0.10	222.0 8.74	12.80 28.19
86669	86100	Y2S-86100	0.8 0.03	180.0 7.09	3.3 0.13	234.0 9.21	15.10 33.27
X32034XM	Y32034XM	K166076	1.0 0.04	187.0 7.36	2.5 0.10	238.0 9.37	21.75 47.79
EE117067	117148	Y3S-117148	1.5 0.06	205.0 8.07	1.5 0.06	322.0 12.68	85.52 188.51
67786	67720	Y1S-67720	0.5 0.02	185.0 7.28	3.3 0.13	229.0 9.02	14.45 31.85
67790	67720	Y3S-67720	0.5 0.02	188.0 7.40	3.3 0.13	229.0 9.02	13.79 30.39
82680X	82620	Y2S-82620	1.5 0.06	195.0 7.68	3.3 0.13	251.0 9.88	28.09 61.94
HM237545	HM237510	HM237510ED	1.5 0.06	194.0 7.64	3.3 0.13	266.0 10.47	31.62 69.75
EE607070	607140	Y1S-607140	1.5 0.06	204.0 8.03	6.4 0.25	311.9 12.28	72.51 159.87
EE350701	351687	Y1S-351687	1.5 0.06	221.0 8.70	6.4 0.25	365.0 14.37	145.48 320.70
JM736149	JM736110	JY25020-S	0.5 0.02	190.5 7.50	2.5 0.10	232.0 9.13	13.77 30.34
X32936M	Y32936M	K163398	0.6 0.03	192.0 7.56	2.0 0.08	231.0 9.09	13.43 29.63
X32036XM	Y32036XM	K160264	1.0 0.04	197.0 7.76	2.5 0.10	256.0 10.08	28.80 63.46
JM738249	JM738210	K161599	0.5 0.02	200.0 7.87	2.5 0.10	242.0 9.53	14.06 30.99

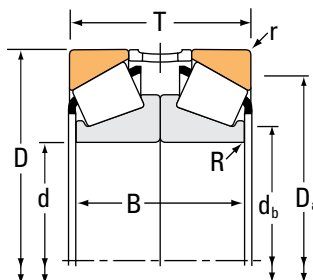
<sup>(5)</sup>Contact your Timken engineer for information on spacer configurations.

<sup>(6)</sup>These maximum fillet radii will be cleared by the bearing corners.

# TAPERED ROLLER BEARINGS

## DOUBLE-ROW • TYPE 2TS-DM

### TYPE 2TS-DM



Bearing Dimensions				Load Ratings							
Bore d	O.D. D	Width <sup>(1)</sup> T	Width B	Dynamic <sup>(2)</sup>				Dynamic <sup>(4)</sup>			
				C <sub>1(2)</sub>	e	Factors <sup>(3)</sup> Y <sub>1</sub>	Y <sub>2</sub>	C <sub>90</sub>	C <sub>a90</sub>	C <sub>90(2)</sub>	Factors <sup>(3)</sup> K
mm in.	mm in.	mm in.	mm in.	N lbf				N lbf	N lbf	N lbf	
190.000 7.4803	290.000 11.4173	128.000 5.0394	128.000 5.0394	1250000 281000	0.44	1.53	2.27	186000 41900	141000 31700	325000 73000	1.32
190.500 7.5000	336.550 13.2500	165.100 6.5000	168.276 6.6250	1640000 370000	0.37	1.85	2.75	245000 55000	153000 34400	426000 95800	1.60
190.500 7.5000	336.550 13.2500	196.850 7.7500	190.500 7.5000	2010000 451000	0.58	1.17	1.75	299000 67100	294000 66200	520000 117000	1.01
190.500 7.5000	428.625 16.8750	212.725 8.3750	190.500 7.5000	2860000 644000	0.76	0.89	1.33	426000 95900	554000 124000	742000 167000	0.77
196.850 7.7500	254.000 10.0000	57.150 2.2500	55.566 2.1876	367000 82500	0.40	1.70	2.53	54700 12300	37100 8350	95200 21400	1.47
200.000 7.8740	310.000 12.2047	140.000 5.5118	140.000 5.5118	1480000 332000	0.43	1.57	2.34	220000 49400	162000 36400	383000 86000	1.36
203.200 8.0000	365.049 14.3720	184.150 7.2500	177.794 6.9998	2030000 457000	0.40	1.68	2.50	303000 68100	208000 46800	527000 118000	1.45
203.200 8.0000	406.400 16.0000	184.150 7.2500	171.450 6.7500	2120000 477000	0.80	0.85	1.26	316000 71000	431000 97000	550000 124000	0.73
204.788 8.0625	292.100 11.5000	115.888 4.5626	115.890 4.5626	1040000 235000	0.33	2.03	3.02	156000 35000	88500 19900	271000 60900	1.76
206.375 8.1250	336.550 13.2500	196.850 7.7500	200.024 7.8750	2360000 530000	0.33	2.03	3.02	351000 79000	200000 45000	612000 137000	1.76
209.550 8.2500	317.500 12.5000	127.000 5.0000	127.000 5.0000	1270000 286000	0.52	1.29	1.92	190000 42600	170000 38200	330000 74200	1.12
209.550 8.2500	333.375 13.1250	139.700 5.5000	139.700 5.5000	1600000 359000	0.44	1.54	2.29	238000 53400	179000 40200	414000 93000	1.33
209.550 8.2500	355.600 14.0000	136.525 5.3750	133.350 5.2500	1320000 297000	0.59	1.14	1.70	197000 44200	199000 44700	343000 77000	0.99
215.900 8.5000	290.010 11.4177	63.500 2.5000	63.500 2.5000	416000 93600	0.39	1.75	2.61	62000 13900	40900 9190	108000 24300	1.52
222.250 8.7500	482.600 19.0000	234.950 9.2500	190.500 7.5000	2870000 646000	0.87	0.78	1.16	428000 96200	635000 143000	745000 168000	0.67
228.397 8.9920	431.800 17.0000	184.149 7.2500	171.450 6.7500	2220000 499000	0.88	0.76	1.14	330000 74300	500000 112000	575000 129000	0.66
228.460 8.9945	431.800 17.0000	184.150 7.2500	171.450 6.7500	2220000 499000	0.88	0.76	1.14	330000 74300	500000 112000	575000 129000	0.66

<sup>(1)</sup>Overall width can vary depending on spacer selection. Contact your Timken engineer for more information.

<sup>(2)</sup>Based on  $1 \times 10^6$  revolutions  $L_{10}$  life, for the ISO life-calculation method.  $C_{1(2)}$  is the double-row radial value.

<sup>(3)</sup>Consult your Timken engineer for instructions on use or review the Timken Engineering Manual on [timken.com/catalogs](http://timken.com/catalogs).

<sup>(4)</sup>Based on  $90 \times 10^6$  revolutions  $L_{10}$  life, for The Timken Company life-calculation method.  $C_{90}$  and  $C_{a90}$  are radial and thrust values.  $C_{90(2)}$  is the double-row radial value.

Part Number			Dimensions				Bearing Weight
Inner	Outer	Outer Spacer <sup>(5)</sup>	Shaft		Housing		
			Max. Shaft Fillet Radius R <sup>(6)</sup>	Backing Shoulder Dia. d <sub>b</sub>	Max. Housing Fillet Radius r <sup>(6)</sup>	Max. Backing Shoulder Dia. D <sub>a</sub>	
			mm in.	mm in.	mm in.	mm in.	kg lbs.
X32038XM	Y32038XM	K162211	1.0 0.04	207.0 8.15	2.5 0.10	267.0 10.51	30.16 66.48
470975	470132	Y1S-470132	1.5 0.06	210.0 8.27	6.4 0.25	298.0 11.73	61.46 135.50
HH840249	HH840210	HH840210EA	1.5 0.06	215.7 8.49	6.4 0.25	290.0 11.42	74.14 163.45
EE350750	351687	Y1S-351687	6.4 0.25	237.0 9.33	6.4 0.25	365.0 14.37	139.80 308.21
L540049	L540010	L540010EA	0.8 0.03	205.0 8.07	1.5 0.06	243.0 9.57	6.97 15.37
X32040XM	Y32040XM	K165677	1.5 0.06	220.0 8.66	2.5 0.10	284.0 11.18	39.08 86.14
EE420801	421437	Y2S-421437	1.5 0.06	227.1 8.94	3.3 0.13	329.0 12.95	78.68 173.48
EE114080	114160	Y2S-114160	1.5 0.06	237.0 9.33	6.4 0.25	349.0 13.74	102.70 226.43
M241549	M241510	M241510EC	1.5 0.06	219.0 8.62	3.3 0.13	272.0 10.71	24.60 54.22
H242649	H242610	K162083	1.5 0.06	227.0 8.94	3.3 0.13	306.0 12.05	68.69 151.44
93825	93125	Y6S-93125	1.3 0.05	226.9 8.93	3.3 0.13	286.0 11.26	35.47 78.21
HM743345	HM743310	HM743310EB	1.5 0.06	228.0 8.98	6.4 0.25	303.0 11.93	46.10 101.64
96825	96140	Y7S-96140	1.5 0.06	235.0 9.25	3.3 0.13	318.0 12.52	57.44 126.67
543085	543114	Y2S-543114	0.8 0.03	226.0 8.90	3.3 0.13	272.0 10.71	11.62 25.62
EE380875	380190	Y2S-380190	1.5 0.06	267.0 10.51	6.4 0.25	402.0 15.83	193.74 427.10
EE113089	113170	Y2S-113170	3.3 0.13	267.0 10.51	6.4 0.25	375.0 14.76	114.78 253.04
EE113091	113170	Y4S-113170	3.3 0.13	267.0 10.51	6.4 0.25	375.0 14.76	115.43 254.48

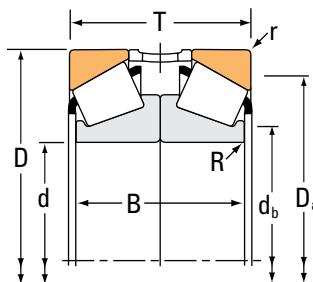
<sup>(5)</sup>Contact your Timken engineer for information on spacer configurations.

<sup>(6)</sup>These maximum fillet radii will be cleared by the bearing corners.

# TAPERED ROLLER BEARINGS

## DOUBLE-ROW • TYPE 2TS-DM

### TYPE 2TS-DM



Bearing Dimensions				Load Ratings							
Bore d	O.D. D	Width <sup>(1)</sup> T	Width B	Dynamic <sup>(2)</sup>		Factors <sup>(3)</sup>		Dynamic <sup>(4)</sup>			Factors <sup>(3)</sup>
				C <sub>1(2)</sub>	e	Y <sub>1</sub>	Y <sub>2</sub>	C <sub>90</sub>	C <sub>a90</sub>	C <sub>90(2)</sub>	K
mm in.	mm in.	mm in.	mm in.	N lbf				N lbf	N lbf	N lbf	
228.600 9.0000	300.038 11.8125	66.675 2.6250	63.500 2.5000	414000 93000	0.40	1.68	2.50	61600 13900	42400 9530	107000 24100	1.45
228.600 9.0000	320.675 12.6250	101.600 4.0000	98.424 3.8750	961000 216000	0.49	1.39	2.06	143000 32200	119000 26800	249000 56000	1.20
228.600 9.0000	355.600 14.0000	136.525 5.3750	133.350 5.2500	1320000 297000	0.59	1.14	1.70	197000 44200	199000 44700	343000 77000	0.99
228.600 9.0000	488.950 19.2500	247.650 9.7500	222.250 8.7500	3910000 879000	0.94	0.72	1.07	582000 131000	934000 210000	1010000 228000	0.62
228.600 9.0000	508.000 20.0000	234.950 9.2500	190.500 7.5000	2920000 656000	0.94	0.72	1.07	434000 97700	697000 157000	756000 170000	0.62
234.950 9.2500	384.175 15.1250	225.425 8.8750	225.424 8.8750	2920000 656000	0.33	2.03	3.02	434000 97600	247000 55600	756000 170000	1.76
240.000 9.4488	360.000 14.1732	152.000 5.9842	152.000 5.9842	2060000 463000	0.46	1.47	2.19	306000 68900	241000 54100	534000 120000	1.27
247.650 9.7500	406.400 16.0000	231.775 9.1250	234.950 9.2500	3620000 814000	0.33	2.03	3.02	539000 121000	307000 69000	939000 211000	1.76
254.000 10.0000	533.400 21.0000	266.700 10.5000	241.300 9.5000	4670000 1050000	0.94	0.72	1.07	696000 156000	1120000 251000	1210000 272000	0.62
254.000 10.0000	558.800 22.0000	209.550 8.2500	209.550 8.2500	3130000 704000	0.87	0.78	1.16	466000 105000	691000 155000	812000 182000	0.67
264.975 10.4321	355.600 14.0000	114.300 4.5000	124.000 4.8818	1270000 286000	0.36	1.87	2.79	189000 42600	117000 26300	330000 74200	1.62
266.700 10.5000	444.500 17.5000	241.300 9.5000	234.950 9.2500	3180000 714000	0.58	1.17	1.75	473000 106000	466000 105000	823000 185000	1.01
285.750 11.2500	358.775 14.1250	66.675 2.6250	63.500 2.5000	449000 101000	0.49	1.37	2.04	66800 15000	56300 12600	116000 26200	1.19
304.800 12.0000	406.400 16.0000	127.000 5.0000	127.000 5.0000	1340000 301000	0.44	1.53	2.28	199000 44800	151000 33900	347000 78100	1.32
304.800 12.0000	499.948 19.6830	203.200 8.0000	158.750 6.2500	2330000 523000	1.17	0.58	0.86	346000 77900	695000 156000	603000 136000	0.50
360.000 14.1732	480.000 18.8976	152.000 5.9843	152.000 5.9842	2170000 489000	0.46	1.47	2.19	324000 72800	254000 57100	564000 127000	1.27
381.000 15.0000	479.425 18.8750	98.425 3.8750	95.250 3.7500	1030000 232000	0.50	1.36	2.03	154000 34600	130000 29300	268000 60300	1.18

<sup>(1)</sup>Overall width can vary depending on spacer selection. Contact your Timken engineer for more information.

<sup>(2)</sup>Based on  $1 \times 10^6$  revolutions  $L_{10}$  life, for the ISO life-calculation method.  $C_{1(2)}$  is the double-row radial value.

<sup>(3)</sup>Consult your Timken engineer for instructions on use or review the Timken Engineering Manual on [timken.com/catalogs](http://timken.com/catalogs).

<sup>(4)</sup>Based on  $90 \times 10^6$  revolutions  $L_{10}$  life, for The Timken Company life-calculation method.  $C_{90}$  and  $C_{a90}$  are radial and thrust values.  $C_{90(2)}$  is the double-row radial value.



Part Number			Dimensions				Bearing Weight
Inner	Outer	Outer Spacer <sup>(5)</sup>	Shaft		Housing		
			Max. Shaft Fillet Radius R <sup>(6)</sup>	Backing Shoulder Dia. d <sub>b</sub>	Max. Housing Fillet Radius r <sup>(6)</sup>	Max. Backing Shoulder Dia. D <sub>a</sub>	
			mm in.	mm in.	mm in.	mm in.	kg lbs.
544090	544118	Y4S-544118	1.5 0.06	240.0 9.45	3.3 0.13	282.0 11.10	11.91 26.22
88900	88126	Y1S-88126	0.8 0.03	242.0 9.53	3.3 0.13	299.0 11.77	23.73 52.27
96900	96140	Y5S-96140	1.5 0.06	249.0 9.80	3.3 0.13	318.0 12.52	49.44 109.04
HH949549	HH949510	K80686	1.5 0.06	280.0 11.02	6.4 0.25	416.0 16.38	214.23 472.33
EE390090	390200	Y1S-390200	1.5 0.06	277.0 10.91	6.4 0.25	423.0 16.65	215.02 474.05
H247549	H247510	H247510EB	1.5 0.06	263.0 10.35	6.4 0.25	346.0 13.62	104.72 230.88
X32048X	Y32048X	K163891	2.0 0.08	259.0 10.20	3.0 0.12	331.0 13.03	53.32 117.52
HH249949	HH249910	HH249910ES	1.5 0.06	275.0 10.83	6.4 0.25	366.0 14.41	125.29 276.23
HH953749	HH953710	K85370	1.5 0.06	306.3 12.06	6.4 0.25	455.0 17.91	275.73 607.88
EE620100	620220	Y1S-620220	3.3 0.13	308.0 12.13	8.0 0.31	477.0 18.78	282.99 623.87
LM451347	LM451310	LM451310EC	1.5 0.06	280.0 11.02	3.3 0.13	335.0 13.19	32.47 71.59
H852849	H852810	H852810EB	1.5 0.06	296.9 11.69	6.4 0.25	390.0 15.35	150.83 332.55
545112	545141	Y2S-545141	1.5 0.06	298.0 11.73	3.3 0.13	340.0 13.39	15.01 33.08
LM757049	LM757010	LM757010ES	1.5 0.06	322.0 12.68	3.3 0.13	380.0 14.96	43.24 95.31
M959442	M959410	M959410EB	1.5 0.06	344.0 13.54	6.4 0.25	438.0 17.24	138.33 304.94
X32972M	Y32972M	K161931	1.5 0.06	378.0 14.88	3.0 0.12	451.0 17.76	92.80 164.88
L865547	L865512	L865512EA	0.8 0.03	395.0 15.55	3.3 0.13	456.0 17.95	39.00 85.96

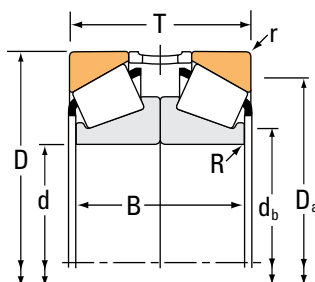
<sup>(5)</sup>Contact your Timken engineer for information on spacer configurations.

<sup>(6)</sup>These maximum fillet radii will be cleared by the bearing corners.

# TAPERED ROLLER BEARINGS

## DOUBLE-ROW • TYPE 2TS-DM

### TYPE 2TS-DM



Bearing Dimensions				Load Ratings							
Bore d	O.D. D	Width <sup>(1)</sup> T	Width B	Dynamic <sup>(2)</sup>				Dynamic <sup>(4)</sup>			
				C <sub>1(2)</sub>	e	Factors <sup>(3)</sup> Y <sub>1</sub>	Y <sub>2</sub>	C <sub>90</sub>	C <sub>a90</sub>	C <sub>90(2)</sub>	Factors <sup>(3)</sup> K
mm in.	mm in.	mm in.	mm in.	N lbf				N lbf	N lbf	N lbf	
400.000 15.7480	510.000 20.0787	124.000 4.8819	124.000 4.8818	1720000 386000	0.37	1.85	2.75	255000 57400	160000 35900	445000 100000	1.60
406.400 16.0000	549.275 21.6250	171.450 6.7500	168.276 6.6250	2490000 561000	0.41	1.66	2.47	371000 83500	259000 58200	646000 145000	1.43
431.800 17.0000	571.500 22.5000	149.225 5.8750	149.224 5.8750	2140000 481000	0.55	1.24	1.84	319000 71700	298000 67000	555000 125000	1.07
460.000 18.1102	860.000 33.8583	420.000 16.5354	380.000 14.9606	12500000 2810000	0.58	1.17	1.75	1860000 419000	1840000 413000	3240000 729000	1.01
476.250 18.7500	565.150 22.2500	82.550 3.2500	82.550 3.2500	817000 184000	0.47	1.44	2.14	122000 27400	97800 22000	212000 47600	1.24
482.600 19.0000	615.950 24.2500	107.950 4.2500	92.076 3.6250	1140000 257000	0.35	1.93	2.88	170000 38200	102000 22900	296000 66600	1.67
560.000 22.0472	1080.000 42.5197	530.022 20.8670	470.000 18.5040	18600000 4190000	0.47	1.45	2.16	2770000 624000	2210000 497000	4830000 1090000	1.25
710.000 27.9528	950.000 37.4016	226.000 8.8976	212.000 8.3464	7050000 1580000	0.46	1.47	2.19	1050000 236000	824000 185000	1830000 411000	1.27
723.900 28.5000	914.400 36.0000	168.275 6.6250	161.924 6.3750	4150000 934000	0.38	1.77	2.64	619000 139000	403000 90600	1080000 242000	1.54
762.000 30.0000	889.000 35.0000	139.700 5.5000	139.700 5.5000	1880000 423000	0.38	1.78	2.65	280000 62900	182000 40800	488000 110000	1.54
857.250 33.7500	1092.200 43.0000	241.300 9.5000	222.250 8.7500	5060000 1140000	0.56	1.21	1.80	754000 169000	719000 162000	1310000 295000	1.05

<sup>(1)</sup>Overall width can vary depending on spacer selection. Contact your Timken engineer for more information.

<sup>(2)</sup>Based on  $1 \times 10^6$  revolutions  $L_{10}$  life, for the ISO life-calculation method.  $C_{1(2)}$  is the double-row radial value.

<sup>(3)</sup>Consult your Timken engineer for instructions on use or review the Timken Engineering Manual on [timken.com/catalogs](http://timken.com/catalogs).

<sup>(4)</sup>Based on  $90 \times 10^6$  revolutions  $L_{10}$  life, for The Timken Company life-calculation method.  $C_{90}$  and  $C_{a90}$  are radial and thrust values.  $C_{90(2)}$  is the double-row radial value.

Part Number			Dimensions				Bearing Weight
Inner	Outer	Outer Spacer <sup>(5)</sup>	Shaft		Housing		
			Max. Shaft Fillet Radius R <sup>(6)</sup>	Backing Shoulder Dia. d <sub>b</sub>	Max. Housing Fillet Radius r <sup>(6)</sup>	Max. Backing Shoulder Dia. D <sub>a</sub>	
			mm in.	mm in.	mm in.	mm in.	kg lbs.
NP852610	NP588721	K167429	1.5 0.06	418.0 16.46	3.3 0.13	484.0 19.06	62.34 137.44
LM567949	LM567910	LM567910EA	1.5 0.06	427.0 16.81	3.3 0.13	519.0 20.43	111.23 245.21
LM869448	LM869410	LM869410EB	1.5 0.06	453.0 17.83	3.3 0.13	537.0 21.14	102.28 225.49
NP837820	NP562053	K163378	2.5 0.10	540.0 21.26	6.0 0.24	765.0 30.12	1087.00 2396.41
LL771948	LL771911	LL771911EA	1.5 0.06	491.0 19.33	3.3 0.13	543.0 21.38	39.55 87.18
80480	80425	Y3S-80425	1.5 0.06	501.0 19.72	3.3 0.13	582.0 22.91	74.57 164.36
NP378108	NP676901	K165076	9.5 0.37	660.0 25.98	12.7 0.50	954.0 37.56	2182.15 4810.80
NP194866	NP089744	K167026	3.0 0.12	744.0 29.29	6.0 0.24	897.0 35.31	445.68 982.52
EE755285	755360	K162084	1.5 0.06	750.0 29.53	6.4 0.25	873.0 34.37	260.54 574.38
EE175300	175350	Y2S-175350	1.5 0.06	780.0 30.71	3.3 0.13	855.0 33.66	141.22 311.37
EE157337	157430	Y1S-157430	3.3 0.13	894.0 35.20	6.4 0.25	1035.0 40.75	516.72 1139.23

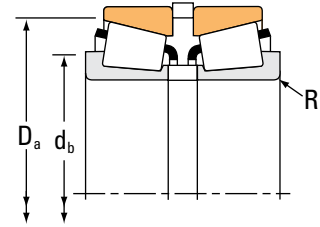
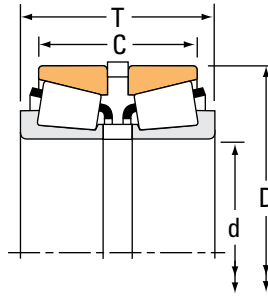
<sup>(5)</sup> Contact your Timken engineer for information on spacer configurations.

<sup>(6)</sup> These maximum fillet radii will be cleared by the bearing corners.

# TAPERED ROLLER BEARINGS

## DOUBLE-ROW • TYPE 2S

### TYPE 2S



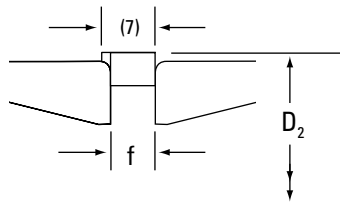
Bearing Dimensions				Load Ratings							
Bore d	O.D. D	Width <sup>(1)</sup> T	Width C	Dynamic <sup>(2)</sup>				Dynamic <sup>(4)</sup>			
				C <sub>1(2)</sub>	e	Factors <sup>(3)</sup> Y <sub>1</sub>	Y <sub>2</sub>	C <sub>90</sub>	C <sub>a90</sub>	C <sub>90(2)</sub>	Factors <sup>(3)</sup> K
mm in.	mm in.	mm in.	mm in.	N lbf				N lbf	N lbf	N lbf	
14.989 0.5901	34.988 1.3775	24.536 0.9660	20.000 0.7874	22900 5150	0.45	1.49	2.22	3410 767	2640 594	5940 1330	1.29
17.462 0.6875	39.878 1.5700	30.226 1.1900	23.876 0.9400	51100 11500	0.29	2.36	3.51	7610 1710	3730 838	13300 2980	2.04
19.050 0.7500	45.237 1.7810	38.100 1.5000	31.242 1.2300	68100 15300	0.30	2.25	3.34	10100 2280	5220 1170	17700 3970	1.94
25.400 1.0000	50.292 1.9800	31.623 1.2450	24.511 0.9650	62000 13900	0.37	1.80	2.69	9230 2080	5910 1330	16100 3610	1.56
25.400 1.0000	57.150 2.2500	39.243 1.5450	31.308 1.2326	94900 21300	0.35	1.95	2.90	14100 3180	8380 1880	24600 5530	1.69
31.750 1.2500	59.131 2.3280	35.712 1.4060	27.584 1.0860	81300 18300	0.41	1.64	2.44	12100 2720	8550 1920	21100 4740	1.42
31.750 1.2500	62.000 2.4409	46.355 1.8250	36.830 1.4500	104000 23400	0.35	1.93	2.87	15500 3490	9310 2090	27000 6080	1.67
33.337 1.3125	68.262 2.6875	46.812 1.8430	37.286 1.4680	133000 29900	0.55	1.24	1.84	19800 4450	18500 4160	34400 7740	1.07
34.925 1.3750	65.088 2.5625	39.624 1.5600	31.496 1.2400	112000 25300	0.38	1.79	2.67	16700 3760	10800 2430	29200 6550	1.55
34.925 1.3750	65.088 2.5625	49.276 1.9400	41.148 1.6200	112000 25300	0.38	1.79	2.67	16700 3760	10800 2430	29200 6550	1.55
34.925 1.3750	72.233 2.8438	55.730 2.1941	44.614 1.7565	134000 30100	0.55	1.24	1.84	19900 4480	18600 4180	34700 7790	1.07
35.000 1.3780	73.025 2.8750	56.337 2.2180	46.812 1.8430	156000 35000	0.37	1.83	2.72	23200 5210	14700 3300	40400 9080	1.58
38.100 1.5000	65.088 2.5625	39.624 1.5600	31.496 1.2400	84600 19000	0.33	2.03	3.02	12600 2830	7170 1610	21900 4930	1.76
38.100 1.5000	65.088 2.5625	39.624 1.5600	31.496 1.2400	84600 19000	0.33	2.03	3.02	12600 2830	7170 1610	21900 4930	1.76
41.275 1.6250	73.431 2.8910	42.113 1.6580	32.461 1.2780	130000 29300	0.40	1.69	2.52	19400 4360	13300 2980	33800 7590	1.46
41.275 1.6250	73.431 2.8910	42.672 1.6800	33.020 1.3000	130000 29300	0.40	1.69	2.52	19400 4360	13300 2980	33800 7590	1.46
45.000 1.7717	75.000 2.9528	44.560 1.7543	35.560 1.4000	137000 30800	0.39	1.72	2.56	20400 4590	13700 3080	35500 7990	1.49

<sup>(1)</sup>Overall width can vary depending on spacer selection. Contact your Timken engineer for more information.

<sup>(2)</sup>Based on  $1 \times 10^6$  revolutions  $L_{10}$  life, for the ISO life-calculation method.  $C_{1(2)}$  is the double-row radial value.

<sup>(3)</sup>Consult your Timken engineer for instructions on use or review the Timken Engineering Manual on [timken.com/catalogs](http://timken.com/catalogs).

<sup>(4)</sup>Based on  $90 \times 10^6$  revolutions  $L_{10}$  life, for The Timken Company life-calculation method.  $C_{90}$  and  $C_{a90}$  are radial and thrust values.  $C_{90(2)}$  is the double-row radial value.



<sup>(7)</sup>Housing groove width with less than critical location =  
 $f + 0.25 \text{ mm}$   $+0.10 \text{ mm}$   
 $f + 0.010 \text{ in.}$   $-0.10 \text{ mm tolerance}$   
 $+0.004 \text{ in.}$   $-0.000 \text{ in. tolerance}$

Part Number				Dimensions					Bearing Weight
Inner	Outer	Inner Spacer <sup>(5)</sup>	Outer Spacer <sup>(5)</sup>	Shaft		Housing	Snap Ring Groove		
				Max Shaft Fillet Radius	Backing Shoulder Dia.	Backing Shoulder Dia.	D <sub>2</sub>	f <sup>(7)</sup>	
				R <sup>(6)</sup>	d <sub>b</sub>	D <sub>a</sub>			
				mm	mm	mm	mm	mm	
				in.	in.	in.	in.	in.	
A4059	A4138	X5SA4059	K524667R	0.8 0.03	19.5 0.77	32.0 1.26	36.35 1.43	2.54 0.10	0.10 0.24
LM11749	LM11710	K106398R	K106397R	1.3 0.05	24.0 0.94	37.0 1.46	41.91 1.65	2.54 0.10	0.19 0.39
LM11949	LM11910	K107061R	K107087R	1.3 0.05	25.0 0.98	41.5 1.63	46.81 1.84	7.11 0.28	0.28 0.63
L44643	L44610	K106790R	K106789R	1.3 0.05	32.0 1.26	47.0 1.85	52.78 2.08	3.18 0.13	0.28 0.60
15578	15520	X1S-15578	K158879R	1.3 0.05	32.5 1.28	53.0 2.09	59.72 2.35	0.34 0.17	0.47 1.02
LM67048	LM67010	K106817R	K106610R	3.5 0.14	42.5 1.67	56.0 2.20	61.11 2.41	3.96 0.16	0.39 0.84
15125	15245	X1S-15125	K159808R	3.5 0.14	42.5 1.67	58.0 2.28	64.52 2.54	8.26 0.33	0.56 1.23
M88048	M88010	K147783R	K528895R	0.8 0.03	42.5 1.67	65.0 2.56	72.34 2.85	2.36 0.09	0.78 1.73
LM48548	LM48510	K106389R	K106390R	3.5 0.14	48.0 1.89	61.0 2.40	67.46 2.66	3.56 0.14	0.53 1.14
LM48548	LM48510	LM48548XE	K106390R	3.5 0.14	48.0 1.89	61.0 2.40	67.46 2.66	3.56 0.14	0.57 1.23
HM88649	HM88610	K152757	K152758	2.3 0.09	48.5 1.91	69.0 2.72	75.00 2.95	4.93 0.19	1.03 2.29
23691	23621	K143257R	K109519R	3.5 0.14	49.0 1.93	68.0 2.68	76.48 3.01	2.36 0.09	1.06 2.34
LM29749	LM29710	K106393R	K106390R	2.3 0.09	46.5 1.83	62.0 2.44	67.46 2.66	3.56 0.14	0.50 1.09
LM29748	LM29710	K106393R	K106390R	3.5 0.14	49.0 1.93	62.0 2.44	67.46 2.66	3.56 0.14	0.48 1.05
LM501349	LM501310	K426891R	K150486R	3.5 0.14	54.0 2.13	70.0 2.76	76.20 3.00	3.00 0.12	0.71 1.55
LM501349	LM501310	K426891R	K426892R	3.5 0.14	54.0 2.13	70.0 2.76	76.20 3.00	3.56 0.14	0.72 1.56
X32009X	Y32009X	JX4505A	K143262R	1.0 0.04	53.0 2.09	72.0 2.83	78.50 3.09	4.57 0.18	0.75 1.66

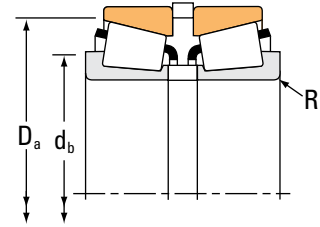
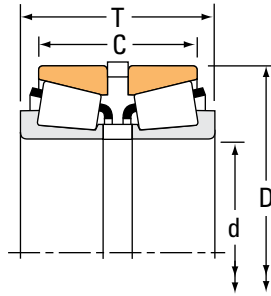
<sup>(5)</sup>Contact your Timken engineer for information on spacer configurations.

<sup>(6)</sup>These maximum fillet radii will be cleared by bearing corners.

# TAPERED ROLLER BEARINGS

## DOUBLE-ROW • TYPE 2S

### TYPE 2S



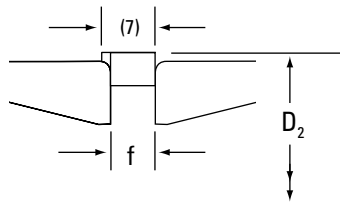
Bearing Dimensions				Load Ratings							
Bore d	O.D. D	Width <sup>(1)</sup> T	Width C	Dynamic <sup>(2)</sup>				Dynamic <sup>(4)</sup>			
				C <sub>1(2)</sub>	e	Factors <sup>(3)</sup> Y <sub>1</sub>	Y <sub>2</sub>	C <sub>90</sub>	C <sub>a90</sub>	C <sub>90(2)</sub>	Factors <sup>(3)</sup> K
mm in.	mm in.	mm in.	mm in.	N lbf				N lbf	N lbf	N lbf	
45.242 1.7812	73.431 2.8910	42.672 1.6800	35.052 1.3800	127000 28500	0.31	2.21	3.29	18900 4250	9870 2220	32900 7400	1.91
45.242 1.7812	77.788 3.0625	44.247 1.7420	34.722 1.3670	133000 29900	0.43	1.58	2.35	19800 4450	14500 3250	34400 7740	1.37
52.387 2.0625	92.075 3.6250	54.752 2.1556	45.227 1.7806	172000 38700	0.38	1.79	2.66	25700 5770	16600 3720	44700 10000	1.55
53.975 2.1250	88.900 3.5000	43.637 1.7180	32.522 1.2804	114000 25600	0.55	1.24	1.84	17000 3820	15900 3570	29500 6640	1.07
57.150 2.2500	112.712 4.4375	66.675 2.6250	53.975 2.1250	291000 65300	0.34	1.99	2.96	43300 9730	25100 5650	75400 16900	1.72
61.912 2.4375	110.000 4.3307	49.535 1.9502	43.185 1.7002	172000 38700	0.40	1.68	2.50	25600 5760	17600 3970	44600 10000	1.45
63.500 2.5000	112.712 4.4375	66.675 2.6250	53.975 2.1250	344000 77400	0.34	1.99	2.96	51300 11500	29800 6700	89300 20100	1.72
66.675 2.6250	112.712 4.4375	66.675 2.6250	53.975 2.1250	291000 65300	0.34	1.99	2.96	43300 9730	25100 5650	75400 16900	1.72
68.262 2.6875	110.000 4.3307	49.433 1.9462	43.083 1.6962	172000 38700	0.40	1.68	2.50	25600 5760	17600 3970	44600 10000	1.45
68.262 2.6875	110.000 4.3307	49.611 1.9532	43.261 1.7032	172000 38700	0.40	1.68	2.50	25600 5760	17600 3970	44600 10000	1.45
83.345 3.2813	125.412 4.9375	54.762 2.1560	43.652 1.7186	204000 45900	0.42	1.62	2.42	30400 6830	21600 4860	52900 11900	1.40
88.900 3.5000	121.442 4.7812	35.702 1.4056	27.762 1.0930	104000 23300	0.33	2.04	3.04	15400 3470	8730 1960	26800 6030	1.77

<sup>(1)</sup>Overall width can vary depending on spacer selection. Contact your Timken engineer for more information.

<sup>(2)</sup>Based on  $1 \times 10^6$  revolutions  $L_{10}$  life, for the ISO life-calculation method.  $C_{1(2)}$  is the double-row radial value.

<sup>(3)</sup>Consult your Timken engineer for instructions on use or review the Timken Engineering Manual on [timken.com/catalogs](http://timken.com/catalogs).

<sup>(4)</sup>Based on  $90 \times 10^6$  revolutions  $L_{10}$  life, for The Timken Company life-calculation method.  $C_{90}$  and  $C_{a90}$  are radial and thrust values.  $C_{90(2)}$  is the double-row radial value.



<sup>(7)</sup>Housing groove width with less than critical location =  
 $f + 0.25 \text{ mm} \quad +0.10 \text{ mm}$   
 $\quad \quad \quad -0.10 \text{ mm tolerance}$   
 $f + 0.010 \text{ in.} \quad +0.004 \text{ in.}$   
 $\quad \quad \quad -0.000 \text{ in. tolerance}$

Part Number				Dimensions					Bearing Weight
Inner	Outer	Inner Spacer <sup>(5)</sup>	Outer Spacer <sup>(5)</sup>	Shaft		Housing	Snap Ring Groove		
				Max Shaft Fillet Radius	Backing Shoulder Dia.	Backing Shoulder Dia.	D <sub>2</sub>	f <sup>(7)</sup>	
				R <sup>(6)</sup>	d <sub>b</sub>	D <sub>a</sub>			
				mm in.	mm in.	mm in.	mm in.	mm in.	
NP118297	NP422278	LM102949XB	K161783R	3.5 0.14	56.0 2.20	70.0 2.76	76.20 3.00	3.56 0.14	0.66 1.48
LM603049AS	LM603011	K109152R	K109151R	0.8 0.03	53.0 2.09	74.0 2.91	81.33 3.20	4.56 0.18	0.79 1.76
28584	28521	K107577R	K107578R	3.5 0.14	65.0 2.56	87.0 3.43	95.83 3.77	5.54 0.22	1.44 3.20
LM806649	LM806610	K114294R	K114295R	2.3 0.09	65.0 2.56	85.0 3.35	92.61 3.65	5.54 0.22	0.94 2.08
39580	39521	X3S-39580	K326057R	3.5 0.14	74.0 2.91	107.0 4.21	116.74 4.60	6.35 0.25	2.93 6.48
392	394A	K444667R	K444668R	0.8 0.03	70.0 2.76	105.0 4.13	116.10 4.57	5.54 0.22	1.84 4.08
39585P	39521P	K167544	K326057R	3.5 0.14	79.0 3.11	107.0 4.21	116.74 4.60	6.35 0.25	2.68 5.92
39590	39521	K326056R	K326057R	3.5 0.14	82.0 3.23	107.0 4.21	116.74 4.60	6.35 0.25	2.47 5.46
399A	394A	X5S-399A	XC914-SD	2.3 0.09	78.0 3.07	105.0 4.13	114.05 4.49	5.54 0.22	1.67 3.68
399A	394A	K143291	K143293R	2.3 0.09	78.0 3.07	105.0 4.13	114.05 4.49	5.61 0.22	1.65 3.63
27690	27620	K107581R	K107582R	3.5 0.14	96.0 3.78	120.0 4.72	130.07 5.12	3.96 0.16	2.24 4.91
LL217849	LL217810	LL217849XB	K143253R	1.5 0.06	97.0 3.82	117.0 4.61	126.14 4.97	5.54 0.22	1.11 2.43

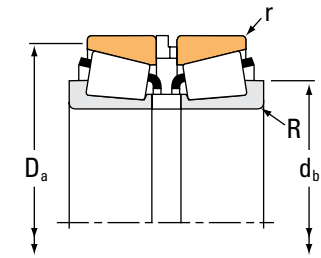
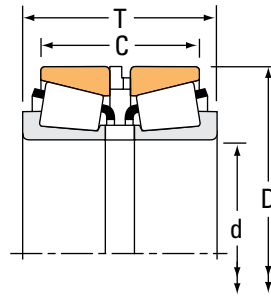
<sup>(5)</sup>Contact your Timken engineer for information on spacer configurations.

<sup>(6)</sup>These maximum fillet radii will be cleared by bearing corners.

# TAPERED ROLLER BEARINGS

## DOUBLE-ROW • TYPE SR

### TYPE SR



Bearing Dimensions				Load Ratings							
Bore d	O.D. D	Width <sup>(1)</sup> T	Width C	Dynamic <sup>(2)</sup>				Dynamic <sup>(4)</sup>			
				C <sub>1(2)</sub>	e	Factors <sup>(3)</sup> Y <sub>1</sub>	Y <sub>2</sub>	C <sub>90</sub>	C <sub>a90</sub>	C <sub>90(2)</sub>	Factors <sup>(3)</sup> K
mm in.	mm in.	mm in.	mm in.	N lbf				N lbf	N lbf	N lbf	
50.000 1.9685	82.000 3.2283	49.000 1.9291	39.425 1.5522	168000 37700	0.31	2.21	3.29	25000 5610	13000 2930	43500 9770	1.91
50.000 1.9685	90.000 3.5433	62.000 2.4409	51.438 2.0251	255000 57400	0.33	2.05	3.06	38000 8540	21400 4810	66200 14900	1.78
50.000 1.9685	105.000 4.1339	80.000 3.1496	63.540 2.5016	354000 79600	0.49	1.38	2.06	52700 11900	44000 9890	91800 20600	1.20
55.000 2.1654	90.000 3.5433	52.000 2.0472	42.504 1.6734	190000 42600	0.40	1.68	2.50	28200 6340	19400 4370	49100 11000	1.45
55.000 2.1654	90.000 3.5433	52.000 2.0472	40.475 1.5935	196000 44000	0.41	1.66	2.47	29100 6550	20300 4560	50800 11400	1.44
55.000 2.1654	95.000 3.7402	64.000 2.5197	52.418 2.0637	227000 51100	0.33	2.02	3.00	33800 7610	19400 4360	58900 13200	1.74
55.000 2.1654	110.000 4.3307	86.000 3.3858	71.415 2.8116	433000 97400	0.35	1.95	2.90	64500 14500	38300 8600	112000 25300	1.69
55.000 2.1654	110.000 4.3307	95.400 3.7558	80.815 3.1816	433000 97400	0.35	1.95	2.90	64500 14500	38300 8600	112000 25300	1.69
60.000 2.3622	95.000 3.7402	54.000 2.1260	43.491 1.7122	170000 38200	0.40	1.68	2.50	25300 5690	17400 3910	44000 9900	1.45
65.000 2.5591	105.000 4.1339	54.000 2.1260	42.515 1.6738	223000 50200	0.45	1.49	2.21	33200 7470	25800 5810	57900 13000	1.29
65.000 2.5591	110.000 4.3307	62.000 2.4409	50.489 1.9877	291000 65400	0.40	1.68	2.50	43300 9740	29800 6700	75400 17000	1.45
65.000 2.5591	110.000 4.3307	114.300 4.5000	102.718 4.0440	291000 65400	0.40	1.68	2.50	43300 9740	29800 6700	75400 17000	1.45
65.000 2.5591	120.000 4.7244	86.000 3.3858	71.402 2.8111	388000 87300	0.34	2.00	2.98	57800 13000	33400 7500	101000 22600	1.73
70.000 2.7559	110.000 4.3307	58.000 2.2835	46.519 1.8315	199000 44800	0.49	1.38	2.06	29700 6680	24800 5570	51700 11600	1.20
70.000 2.7559	115.000 4.5276	64.000 2.5197	51.507 2.0278	310000 69600	0.43	1.57	2.34	46100 10400	33900 7630	80300 18000	1.36
75.000 2.9528	115.000 4.5276	56.000 2.2047	43.502 1.7126	244000 54900	0.46	1.47	2.19	36400 8180	28600 6420	63400 14200	1.27

<sup>(1)</sup>Overall width can vary depending on spacer selection. Contact your Timken engineer for more information.

<sup>(2)</sup>Based on  $1 \times 10^6$  revolutions  $L_{10}$  life, for the ISO life-calculation method.  $C_{1(2)}$  is the double-row radial value.

<sup>(3)</sup>Consult your Timken engineer for instructions on use or review the Timken Engineering Manual on [timken.com/catalogs](http://timken.com/catalogs).

<sup>(4)</sup>Based on  $90 \times 10^6$  revolutions  $L_{10}$  life, for The Timken Company life-calculation method.  $C_{90}$  and  $C_{a90}$  are radial and thrust values.  $C_{90(2)}$  is the double-row radial value.



Part Number					Dimensions				Bearing Weight without Snap Ring
Inner	Outer	Inner Spacer <sup>(5)</sup>	Outer Spacer <sup>(5)</sup>	Snap Ring <sup>(6)</sup>	Shaft		Housing		
					Max Shaft Fillet Radius	Backing Shoulder Dia.	Max Housing Fillet Radius	Backing Shoulder Dia.	
					R <sup>(7)</sup>	d <sub>b</sub>	r <sup>(l)</sup>	D <sub>a</sub>	
					mm in.	mm in.	mm in.	mm in.	kg lbs.
JLM104948	JLM104910	LM104948XS	LM104910ES	K444653R	3.0 0.12	61.0 2.40	0.4 0.02	78.0 3.07	0.91 2.01
JM205149	JM205110	M205149XS	M205110ES	K516778R	3.0 0.12	63.0 2.48	0.5 0.02	85.0 3.35	1.56 3.44
JHM807045	JHM807012	HM807045XS	HM807012ES	K518781R	3.0 0.12	69.0 2.72	0.8 0.03	100.0 3.94	3.13 6.88
JLM506849	JLM506810	LM506849XS	LM506810ES	K516778R	1.5 0.06	63.0 2.48	0.5 0.02	86.0 3.39	1.15 2.57
X32011X	Y32011X	JXH5506A	JYH9006TSR	K527327R	1.5 0.06	65.0 2.56	0.3 0.01	86.5 3.41	1.20 2.66
JM207049	JM207010	M207049XS	M207010ES	K518779R	1.5 0.06	64.0 2.52	0.5 0.02	91.0 3.58	1.74 3.85
JH307749	JH307710	H307749XS	H307710ES	K518419R	3.0 0.12	71.0 2.80	0.8 0.03	104.0 4.09	3.55 7.81
JH307749	JH307710	H307749XR	H307710ER	K518419R	3.0 0.12	71.0 2.80	0.8 0.03	104.0 4.09	3.83 8.42
JLM508748	JLM508710	LM508748XS	LM508710ES	K518779R	5.0 0.20	75.0 2.95	0.5 0.02	91.0 3.58	1.26 2.77
JLM710949C	JLM710910	LM710949XS	LM710910ES	K518781R	3.0 0.12	78.0 3.07	0.4 0.02	100.5 3.96	1.61 3.53
JM511946	JM511910	M511946XS	M511910ES	K518419R	3.0 0.12	78.0 3.07	0.8 0.03	105.0 4.13	2.24 4.93
JM511946	JM511910	JXH6558A	JYH11058RSR	K518419R	3.0 0.12	78.0 3.07	0.8 0.03	105.0 4.13	3.69 8.12
JH211749	JH211710	H211749XS	H211710ES	K518771R	3.0 0.12	80.0 3.15	1.0 0.04	114.0 4.49	3.92 8.65
JLM813049	JLM813010	LM813049XS	LM813010ES	K518419R	1.0 0.04	78.0 3.07	0.5 0.02	105.0 4.13	1.88 4.11
JM612949	JM612910	M612949XS	M612910ES	K524105R	3.0 0.12	83.0 3.27	0.6 0.03	110.0 4.33	2.36 5.23
JLM714149	JLM714110	LM714149XS	LM714110ES	K524105R	3.0 0.12	88.0 3.46	0.5 0.02	110.5 4.35	1.87 4.12

<sup>(5)</sup> Contact your Timken engineer for information on spacer configurations.

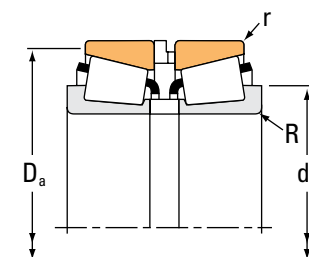
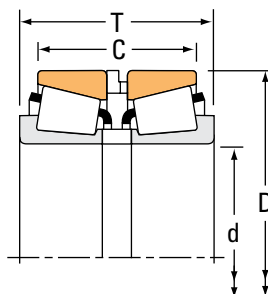
<sup>(6)</sup> If a snap ring is used, the assembly cannot be lubricated through the outer race spacer.

<sup>(7)</sup> These maximum fillet radii will be cleared by the bearing corners.

# TAPERED ROLLER BEARINGS

## DOUBLE-ROW • TYPE SR

### TYPE SR



Bearing Dimensions				Load Ratings							
Bore d	O.D. D	Width <sup>(1)</sup> T	Width C	Dynamic <sup>(2)</sup>				Dynamic <sup>(4)</sup>			
				C <sub>1(2)</sub>	e	Factors <sup>(3)</sup> Y <sub>1</sub>	Y <sub>2</sub>	C <sub>90</sub>	C <sub>a90</sub>	C <sub>90(2)</sub>	Factors <sup>(3)</sup> K
mm in.	mm in.	mm in.	mm in.	N lbf				N lbf	N lbf	N lbf	
75.000 2.9528	120.000 4.7244	69.000 2.7165	57.000 2.2441	277000 62400	0.44	1.52	2.26	41300 9290	31400 7070	71900 16200	1.31
75.000 2.9528	145.000 5.7087	112.000 4.4094	93.400 3.6771	604000 136000	0.36	1.86	2.78	89900 20200	55700 12500	157000 35200	1.61
80.000 3.1496	125.000 4.9213	66.000 2.5984	51.500 2.0276	342000 77000	0.42	1.60	2.38	51000 11500	36900 8300	88800 20000	1.38
80.000 3.1496	130.000 5.1181	78.000 3.0709	64.452 2.5374	410000 92100	0.39	1.74	2.59	61000 13700	40600 9120	106000 23900	1.50
85.000 3.3465	130.000 5.1181	65.975 2.5974	53.491 2.1060	281000 63100	0.44	1.52	2.26	41800 9400	31800 7150	72800 16400	1.31
85.000 3.3465	140.000 5.5118	86.000 3.3858	70.470 2.7744	490000 110000	0.41	1.66	2.47	73000 16400	50900 11400	127000 28600	1.43
85.000 3.3465	140.000 5.5118	128.867 5.0735	113.337 4.4621	490000 110000	0.41	1.66	2.47	73000 16400	50900 11400	127000 28600	1.43
85.000 3.3465	150.000 5.9055	102.000 4.0157	85.390 3.3619	685000 154000	0.33	2.03	3.02	102000 22900	58100 13100	178000 39900	1.76
90.000 3.5433	145.000 5.7087	78.974 3.1092	62.489 2.4602	387000 87000	0.44	1.52	2.26	57700 13000	43900 9860	100000 22600	1.31
90.000 3.5433	155.000 6.1024	98.000 3.8583	80.314 3.1619	683000 153000	0.34	1.98	2.95	102000 22900	59400 13300	177000 39800	1.71
95.000 3.7402	150.000 5.9055	78.000 3.0709	61.466 2.4199	374000 84000	0.44	1.53	2.27	55700 12500	42100 9470	96900 21800	1.32
100.000 3.9370	155.000 6.1024	80.000 3.1496	63.417 2.4967	403000 90600	0.47	1.43	2.12	60000 13500	48600 10900	104000 23500	1.24
100.000 3.9370	160.000 6.2992	90.000 3.5433	71.412 2.8115	576000 130000	0.47	1.43	2.14	85800 19300	69100 15500	149000 33600	1.24
110.000 4.3307	165.000 6.4961	79.756 3.1401	62.413 2.4572	396000 88900	0.50	1.36	2.02	58900 13200	50100 11300	103000 23100	1.18
110.000 4.3307	180.000 7.0866	102.975 4.0541	84.364 3.3215	647000 145000	0.41	1.66	2.48	96300 21600	66900 15000	168000 37700	1.44
110.000 4.3307	180.000 7.0866	103.000 4.0551	84.364 3.3215	647000 145000	0.41	1.66	2.48	96300 21600	66900 15000	168000 37700	1.44

<sup>(1)</sup>Overall width can vary depending on spacer selection. Contact your Timken engineer for more information.

<sup>(2)</sup>Based on  $1 \times 10^6$  revolutions  $L_{10}$  life, for the ISO life-calculation method.  $C_{1(2)}$  is the double-row radial value.

<sup>(3)</sup>Consult your Timken engineer for instructions on use or review the Timken Engineering Manual on [timken.com/catalogs](http://timken.com/catalogs).

<sup>(4)</sup>Based on  $90 \times 10^6$  revolutions  $L_{10}$  life, for The Timken Company life-calculation method.  $C_{90}$  and  $C_{a90}$  are radial and thrust values.  $C_{90(2)}$  is the double-row radial value.

Part Number					Dimensions				Bearing Weight without Snap Ring
Inner	Outer	Inner Spacer <sup>(5)</sup>	Outer Spacer <sup>(5)</sup>	Snap Ring <sup>(6)</sup>	Shaft		Housing		
					Max Shaft Fillet Radius	Backing Shoulder Dia.	Max Housing Fillet Radius	Backing Shoulder Dia.	
					R <sup>(7)</sup>	d <sub>b</sub>	r <sup>(l)</sup>	D <sub>a</sub>	
					mm in.	mm in.	mm in.	mm in.	kg lbs.
JM714249	JM714210	M714249XS	M714210ES	K518771R	3.0 0.12	88.0 3.46	0.6 0.03	115.0 4.53	2.72 6.02
JH415647	JH415610	H415647XS	H415610ES	K524653R	3.0 0.12	94.0 3.70	0.8 0.03	139.0 5.47	8.02 17.70
X32016X	Y32016X	JXH8008AI	JYH12508TSR	K527332R	1.5 0.06	91.0 3.58	0.6 0.03	120.0 4.72	2.72 5.99
JM515649	JM515610	M515649XS	M515610ES	K524112R	3.0 0.12	94.0 3.70	0.6 0.03	125.0 4.92	3.62 8.00
JM716649	JM716610	M716649XS	M716610ES	K523970R	3.0 0.12	98.0 3.86	0.8 0.03	125.0 4.92	2.87 6.34
JHM516849	JHM516810	HM516849XS	HM516810ES	K518333R	3.0 0.12	100.0 3.94	1.0 0.04	134.0 5.28	4.76 10.51
JHM516849	JHM516810	HM516849XB	HM516810EB	K518333R	3.0 0.12	100.0 3.94	1.0 0.04	134.0 5.28	6.51 14.37
JH217249	JH217210	H217249XS	H217210ES	K518773R	3.0 0.12	101.0 3.98	1.3 0.05	142.0 5.59	7.05 15.53
JM718149	JM718110	M718149XS	M718110ES	K524653R	3.0 0.12	106.0 4.17	1.0 0.04	138.8 5.46	4.59 10.11
JHM318448	JHM318410	HM318448XS	HM318410ES	K516800R	3.0 0.12	106.0 4.17	0.8 0.03	148.0 5.83	6.97 15.33
JM719149	JM719113	M719149XS	M719113ES	K518773R	3.0 0.12	109.0 4.29	0.8 0.03	143.0 5.63	4.60 10.15
JM720249	JM720210	JXH10010A	M720210ES	K516800R	3.0 0.12	115.0 4.53	0.8 0.03	149.0 5.87	5.00 11.01
JHM720249	JHM720210	JXH10010A	HM720210ES	K525362R	3.0 0.12	117.0 4.61	0.8 0.03	153.9 6.06	6.31 13.91
JM822049	JM822010	JXH11010A	M822010ES	K524660R	3.0 0.12	125.0 4.92	0.8 0.03	159.0 6.26	5.29 11.70
JHM522649	JHM522610	HM522649XS	HM522610ES	K518334R	3.0 0.12	127.0 5.00	0.8 0.03	172.0 6.77	9.42 20.74
JHM522649	JHM522610	HM522649XE	HM522610ES	K518334R	3.0 0.12	127.0 5.00	0.8 0.03	172.0 6.77	9.40 20.68

<sup>(5)</sup> Contact your Timken engineer for information on spacer configurations.

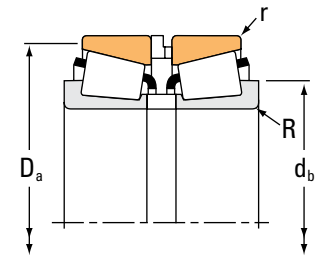
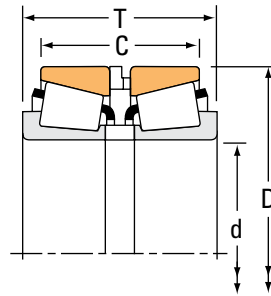
<sup>(6)</sup> If a snap ring is used, the assembly cannot be lubricated through the outer race spacer.

<sup>(7)</sup> These maximum fillet radii will be cleared by the bearing corners.

# TAPERED ROLLER BEARINGS

## DOUBLE-ROW • TYPE SR

### TYPE SR



Bearing Dimensions				Load Ratings							
Bore d	O.D. D	Width <sup>(1)</sup> T	Width C	Dynamic <sup>(2)</sup>				Dynamic <sup>(4)</sup>			
				C <sub>1(2)</sub>	e	Factors <sup>(3)</sup> Y <sub>1</sub>	Y <sub>2</sub>	C <sub>90</sub>	C <sub>a90</sub>	C <sub>90(2)</sub>	Factors <sup>(3)</sup> K
mm in.	mm in.	mm in.	mm in.	N lbf				N lbf	N lbf	N lbf	
<b>170.000</b> 6.6929	<b>240.000</b> 9.4488	<b>101.000</b> 3.9764	<b>82.278</b> 3.2393	<b>699000</b> 157000	0.44	1.54	2.30	<b>104000</b> 23400	<b>77900</b> 17500	<b>181000</b> 40700	1.34
<b>180.000</b> 7.0866	<b>250.000</b> 9.8425	<b>103.000</b> 4.0551	<b>82.288</b> 3.2397	<b>712000</b> 160000	0.48	1.41	2.09	<b>106000</b> 23800	<b>87200</b> 19600	<b>185000</b> 41500	1.22
<b>190.000</b> 7.4803	<b>260.000</b> 10.2362	<b>102.000</b> 4.0157	<b>82.263</b> 3.2387	<b>708000</b> 159000	0.48	1.41	2.11	<b>105000</b> 23700	<b>86200</b> 19400	<b>184000</b> 41300	1.22

<sup>(1)</sup>Overall width can vary depending on spacer selection. Contact your Timken engineer for more information.

<sup>(2)</sup>Based on  $1 \times 10^6$  revolutions  $L_{10}$  life, for the ISO life-calculation method.  $C_{1(2)}$  is the double-row radial value.

<sup>(3)</sup>Consult your Timken engineer for instructions on use or review the Timken Engineering Manual on [timken.com/catalogs](http://timken.com/catalogs).

<sup>(4)</sup>Based on  $90 \times 10^6$  revolutions  $L_{10}$  life, for The Timken Company life-calculation method.  $C_{90}$  and  $C_{a90}$  are radial and thrust values.  $C_{90(2)}$  is the double-row radial value.

Part Number					Dimensions				Bearing Weight without Snap Ring
Inner	Outer	Inner Spacer <sup>(5)</sup>	Outer Spacer <sup>(5)</sup>	Snap Ring <sup>(6)</sup>	Shaft		Housing		
					Max Shaft Fillet Radius	Backing Shoulder Dia.	Max Housing Fillet Radius	Backing Shoulder Dia.	
					R <sup>(7)</sup>	d <sub>b</sub>	r <sup>(1)</sup>	D <sub>a</sub>	
					mm in.	mm in.	mm in.	mm in.	kg lbs.
JM734449	JM734410	M734449XS	M734410ES	K518335R	3.0 0.12	185.0 7.28	1.5 0.06	232.0 9.13	13.16 29.00
JM736149	JM736110	M736149XS	M736110ES	K525377R	3.0 0.12	196.0 7.72	1.0 0.04	242.6 9.55	14.02 30.90
JM738249	JM738210	M738249XS	M738210ES	K525378R	3.0 0.12	206.0 8.11	1.0 0.04	252.0 9.92	14.41 31.75

<sup>(5)</sup> Contact your Timken engineer for information on spacer configurations.

<sup>(6)</sup> If a snap ring is used, the assembly cannot be lubricated through the outer race spacer.

<sup>(7)</sup> These maximum fillet radii will be cleared by the bearing corners.



## ***TAPERED ROLLER THRUST BEARINGS***

**Overview:** Timken® thrust bearings are built to handle high thrust loads and heavy shock. The distinctive on-apex design characteristic of tapered roller thrust bearings ensures true rolling motion, which reduces roller sliding and provides a smoother, cooler-running bearing than other thrust types. Available in a wide range of sizes and design styles, these bearings fit many types of machinery in the industrial and automotive markets.

- **Bore Sizes:** 16.1 mm - 1550.0 mm (0.6337 in. - 61.0236 in.)
- **Industries:** Aggregate, rubber and plastics, metals, oil, gas and power generation.
- **Applications:** Cone crushers, crane hooks, oil well swivels, top drives, extruders, pulverizer drives, rolling mills, machine tool spindles and tables, drilling rig hydraulic heads, gear boxes and pre-heater fans.
- **Benefits:** High performance and application flexibility versus other non-tapered bearing types. Large range of product offerings.



## TAPERED ROLLER THRUST BEARINGS

Timken tapered roller thrust bearings include conical rollers for true rolling motion. These bearings are engineered so that the rollers and raceway converge at a common apex point, which is on the center line of the bearing. Seating force between the rib and roller helps provide positive roller guidance.

Timken manufactures several types of heavy-duty tapered roller thrust bearings: standard (TTHD), V-flat (TTHDFL) and self-aligning V-flat (TTVS). Timken also offers TTSP and TTC, light-duty thrust bearings designed for oscillating applications.

### TTHD

The TTHD design has an identical pair of hardened and ground steel rings with tapered raceways. Because both rings have the same bore and O.D., housings should be designed to clear the O.D. of rotating rings and shafts stepped to clear the bore of stationary rings. Controlled-contour tapered rollers are used and equally spaced by a cage. All components are separable. Most TTHD bearings are supplied with case-carburized components, which are well-suited for applications where extremely high thrust loads and heavy shock may be encountered. For very low-speed applications with unusually high loading, TTHD bearings can be supplied with a full complement of rollers. Extensively used in numerous applications, including oil well swivels, top drives, pulp refiners, extruders and gearboxes. Applications for full-complement bearings should be reviewed by your Timken engineer to help ensure selection of the proper bearing.



Fig. 34. Type TTHD.

### TTHDFL

The TTHDFL combines the outstanding features of tapered and cylindrical roller bearings, offering the highest possible capacity of any thrust bearing of its size. The V-flat design includes one flat ring and one ring having a tapered raceway matching the rollers. These bearings maximize dynamic and static capacity within a given envelope. The design was originally developed for screwdown applications in metal rolling mills. They also have been highly successful in heavily loaded extruders, cone crushers, top drives and other applications where a wide range of operating conditions are found. Most sizes utilize pin-type cages with hardened pins through the center of the rollers, allowing closer spacing of the rollers to maximize capacity. Smaller sizes have brass cages designed for unidirectional retention of rollers.



Fig. 35. Type TTHDFL.



## TTVS

The TTVS design employs the same basic roller and raceway design as the TTHDFL, except the lower ring is in two pieces. The contacting faces of the lower ring are spherically ground, permitting self-alignment under conditions of initial misalignment. TTVS bearings should not be used if dynamic misalignment (changing under load) is expected. These bearings are found in cone crushers, extruders, gear drives and pulp refiners.



Fig. 36. Type TTVS.

## TTSP

Type TTSP thrust bearing is made up of two tapered thrust races, rollers, cage and an outside retainer which holds the components together during shipping and installation. TTSP bearings are light-duty thrust bearings and are used extensively in the steering pivot positions of automotive and other industrial applications.



Fig. 37. Type TTSP.

## TTC, TTCS, TTCL

The types TTC, TTCS and TTCL thrust bearings consist of two tapered thrust races, rollers, and an outside retainer, but do not have a cage. The outside retainer holds the assembly together for shipping and installation. Types TTC, TTCS and TTCL bearings are thrust bearings specifically designed for oscillating applications. The retainer construction varies between types.



Fig. 38. Type TTC.



Fig. 39. Type TTCS.



Fig. 40. Type TTCL.

### TAPERED STANDARD THRUST BEARING NOMENCLATURE

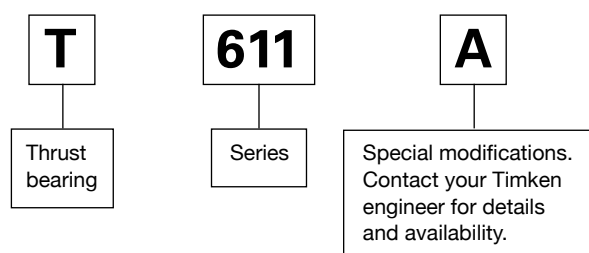


Fig. 41. Tapered thrust bearing nomenclature.

### SPECIAL PART NUMBERS

Timken thrust bearings follow a unique part-numbering system with three main components. Since many thrust bearings are designed for a specific application it is common to use special part numbers.

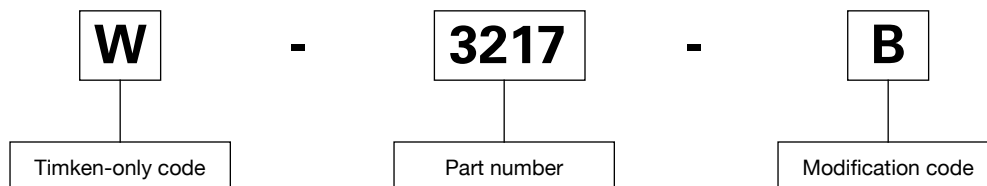
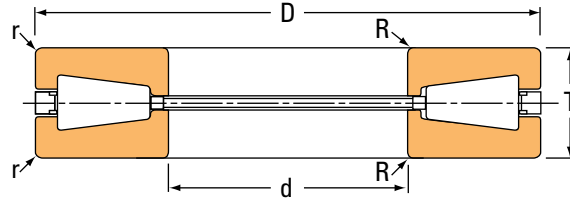


Fig. 42. Special part number nomenclature.

TYPE TTHD



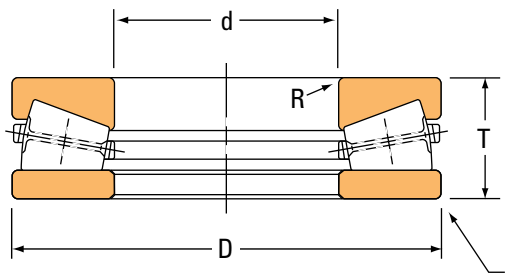
Part Number		Dimensions					Ratings		Bearing Weight
Bearing	Cage Type	Bore	Outside Diameter	Width	Max. Shaft Fillet Radius	Housing Fillet Radius <sup>(1)</sup>	Static	Dynamic <sup>(2)</sup>	
		d	D	T	R	r	C <sub>0</sub>	C <sub>a90</sub>	
		mm in.	mm in.	mm in.	mm in.	mm in.	N lbf	N lbf	kg lbs.
T135	Machined	34.925 1.3750	76.200 3.0000	15.875 0.6250	1.5 0.06	1.5 0.06	317000 71200	31700 7130	0.37 0.82
T1750	Machined	44.450 1.7500	84.734 3.3360	18.258 0.7188	2.3 0.09	2.3 0.09	434000 97700	42000 9460	0.49 1.07
T200A	Machined	50.800 2.0000	109.538 4.3125	22.225 0.8750	2.3 0.09	2.3 0.09	804000 181000	73100 16400	1.04 2.30
T311	Machined	76.200 3.0000	161.925 6.3750	33.338 1.3215	3.3 0.13	3.3 0.13	1760000 395000	152000 34200	3.47 7.66
T311F	Cageless	76.200 3.0000	161.925 6.3750	33.338 1.3215	3.3 0.13	3.3 0.13	2440000 545000	1250000 281000	3.54 7.81
T451	Machined	114.300 4.5000	250.825 9.8750	53.975 2.1250	4.0 0.16	4.0 0.16	4380000 985000	352000 79100	14.20 31.31
T511	Machined	127.000 5.0000	266.700 10.5000	58.738 2.3125	4.8 0.19	4.8 0.19	4580000 1030000	372000 83600	17.03 37.56
T9250FA	Cageless	139.700 5.5000	546.100 21.5000	127.000 5.0000	* *	16.0 0.63	31200000 7050000	16050000 3600000	191.33 421.80
T611	Machined	152.400 6.0000	317.500 12.5000	69.850 2.7500	6.4 0.25	6.4 0.25	6660000 1500000	526000 118000	28.35 62.50
T661	Machined	168.275 6.6250	304.800 12.0000	69.850 2.7500	6.4 0.25	6.4 0.25	5340000 1200000	442000 99300	23.53 51.87
T691	Machined	174.625 6.8750	358.775 14.1250	82.550 3.2500	6.4 0.25	6.4 0.25	7870000 1770000	620000 139000	43.16 95.15
T811	Machined	203.200 8.0000	419.100 16.5000	92.075 3.6250	9.7 0.38	9.7 0.38	11400000 2560000	869000 195000	65.48 144.33
T911	Machined	228.600 9.0000	482.600 19.0000	104.775 4.1250	* *	11.2 0.44	15200000 3420000	1140000 256000	98.25 216.61
T9250F	Cageless	234.950 9.2500	546.100 21.5000	127.000 5.0000	* *	16.0 0.63	31200000 7050000	16050000 3600000	164.84 363.40
T1421	Cageless	355.600 14.0000	533.400 21.0000	101.600 4.0000	* *	6.4 0.25	17200000 3870000	8000000 1790000	82.88 182.72
T16021	Machined	406.400 16.0000	711.200 28.0000	146.050 5.7500	* *	9.7 0.38	29000000 6530000	2130000 480000	259.63 572.38

<sup>(1)</sup>These maximum fillet radii will be cleared by the bearing corners.

<sup>(2)</sup>Dynamic rating C<sub>a90</sub> is for breaker block on cageless designer.

<sup>(\*)</sup>Contact your Timken engineer for details.

### TYPE TTHDFL



Part Number		Dimensions					Ratings		Bearing Weight
Bearing	Cage Type	Bore	Outside Diameter	Width	Shaft Fillet Radius	Housing Fillet Radius <sup>(1)</sup>	Static	Dynamic	
		d	D	T	R	r	C <sub>0</sub>	C <sub>90</sub>	
		mm in.	mm in.	mm in.	mm in.	mm in.	N lbf	N lbf	kg lbs.
F-3167-B	Machined	101.575 3.9990	215.875 8.4990	46.038 1.8125	2.5 0.10	2.5 0.10	1570000 353000	228000 51300	9.30 20.50
T4920-T4921	Machined	124.993 4.9210	185.738 7.3125	25.400 1.0000	1.5 0.06	1.5 0.06	1250000 282000	93300 21000	2.36 5.19
W-3217-B	Machined	127.000 5.0000	266.700 10.5000	58.357 2.2975	3.6 0.14	3.6 0.14	2570000 578000	350000 78800	19.00 41.00
S-4055-C	Machined	149.974 5.9045	299.720 11.8000	89.700 3.5315	3.0 0.12	3.0 0.12	3350000 754000	480000 108000	36.00 79.00
G-3304-B	Pin	168.275 6.6250	304.800 12.0000	69.850 2.7500	6.4 0.25	6.4 0.25	3730000 839000	495000 111000	25.90 57.00
T660V	Cageless	168.275 6.6250	304.800 12.0000	69.850 2.7500	6.4 0.25	6.4 0.25	7090000 1590000	524000 118000	23.10 50.91
W-3218-B	Pin	177.800 7.0000	368.300 14.5000	82.169 3.2350	6.1 0.24	6.1 0.24	6270000 1410000	762000 171000	49.00 109.00
T7010V	Pin	177.800 7.0000	368.300 14.5000	82.550 3.2500	7.9 0.31	7.9 0.31	10900000 2450000	775000 174000	43.86 96.68
F-3094-C	Machined	228.575 8.9990	431.749 16.9980	88.900 3.5000	5.1 0.20	5.1 0.20	7120000 1600000	887000 199000	71.70 158.00
T9011	Pin	228.600 9.0000	482.600 19.0000	104.775 4.1250	1.5 0.06	11.2 0.44	18500000 4170000	1270000 285000	94.85 209.13
DX121944	Pin	234.950 9.2500	21.500 21.5000	127.000 5.0000	1.5 0.06	3.3 0.13	28100000 6320000	2230000 500000	161.88 356.88
I-2077-C	Machined	253.975 9.9990	508.000 20.0000	95.250 3.7500	6.4 0.25	6.4 0.25	10000000 2260000	1170000 264000	110.20 243.00
R-2927-C	Pin	254.000 10.0000	508.000 20.0000	107.950 4.2500	4.8 0.19	4.8 0.19	12100000 2720000	1440000 324000	123.40 272.00
T10100V	Pin	256.540 10.1000	546.100 21.5000	164.719 6.4850	1.5 0.06	6.4 0.25	28300000 6370000	2070000 465000	205.09 452.15
G-3224-C	Pin	256.540 10.1000	546.100 21.5000	165.100 6.5000	6.1 0.24	6.1 0.24	14900000 3350000	2050000 461000	227.20 501.00
S-4077-C	Pin	259.999 10.2362	479.948 18.8956	132.080 5.2000	4.8 0.19	4.8 0.19	8980000 2020000	1220000 275000	126.50 279.00
T11000	Pin	279.400 11.0000	601.675 23.6880	136.525 5.3750	1.5 0.06	11.2 0.44	32200000 7240000	2090000 469000	201.12 443.40
C-8091-C	Pin	279.400 11.0000	603.250 23.7500	136.140 5.3600	11.2 0.44	4.8 0.19	1770000 3980000	2050000 459000	231.00 508.00

<sup>(1)</sup>These maximum fillet radii will be cleared by the bearing corners.

Continued on the next page.

Part Number		Dimensions					Ratings		Bearing Weight
Bearing	Cage Type	Bore	Outside Diameter	Width	Shaft Fillet Radius	Housing Fillet Radius <sup>(1)</sup>	Static	Dynamic	
		d	D	T	R	r	C <sub>0</sub>	C <sub>a90</sub>	
		mm in.	mm in.	mm in.	mm in.	mm in.	N lbf	N lbf	kg lbs.
G-3272-C	Pin	304.775 11.9990	609.600 24.0000	113.792 4.4800	6.4 0.25	6.4 0.25	17800000 3990000	1910000 430000	190.90 421.00
E-1994-C	Pin	304.800 12.0000	673.100 26.5000	171.069 6.7350	7.6 0.30	7.6 0.30	22700000 5100000	2850000 710000	347.80 767.00
F-3090-A	Pin	304.800 12.0000	736.600 29.0000	279.020 10.9850	9.1 0.36	9.1 0.36	28000000 6300000	4430000 998000	729.00 1607.00
I-2060-C	Machined	368.541 14.5095	609.156 23.9825	120.269 4.7350	9.7 0.38	11.2 0.38	11800000 2640000	1510000 340000	176.00 388.00
T15500	Machined	393.700 15.5000	495.300 19.5000	44.450 1.7500	3.3 0.13	3.3 0.13	6900000 1550000	373000 83700	* *
T15501	Polymer	393.700 15.5000	495.300 19.5000	44.450 1.7500	3.3 0.13	3.3 0.13	6900000 1550000	373000 83700	* *
B-8350-C	Machined	406.400 16.0000	711.200 28.0000	167.084 6.5781	9.1 0.36	9.1 0.36	19900000 4480000	2670000 599000	356.50 786.00
F-3163-C	Pin	406.400 16.0000	712.394 28.0470	146.050 5.7500	7.6 0.30	7.6 0.30	19300000 4350000	2380000 537000	303.40 669.00
F-3131-G	Pin	431.800 17.0000	863.600 34.0000	228.219 8.9850	10.2 0.40	10.2 0.40	37700000 8480000	4870000 1100000	774.60 1708.00
DX948645	Pin	457.200 18.0000	914.400 36.0000	181.044 7.1277	6.4 0.25	6.4 0.25	70100000 15800000	5422000 1219000	597.87 1318.10
DX175273	Pin	457.200 18.0000	965.200 38.0000	198.232 7.8044	6.4 0.25	6.4 0.25	18000000 4040000	5730000 1290000	742.59 1637.12
A-6096-C	Machined	508.000 20.0000	990.600 39.0000	196.850 7.7500	12.7 0.50	12.7 0.50	41500000 9320000	4330000 975000	882.50 1946.00
T20751	Polymer	527.050 20.7500	635.000 25.0000	44.450 1.7500	3.3 0.13	3.3 0.13	7750000 1740000	357000 80200	25.82 56.92
F-3093-A	Pin	558.800 22.0000	1066.800 42.0000	285.370 11.2350	10.2 0.40	10.2 0.40	49400000 11100000	7260000 1630000	1405.00 3097.00
F-3172-C	Machined	711.200 28.0000	965.200 38.0000	127.000 5.0000	4.8 0.19	4.8 0.19	19600000 4400000	2250000 506000	354.20 781.00
H-2054-G	Pin	711.200 28.0000	990.600 39.0000	190.119 7.4850	10.2 0.40	10.2 0.40	28000000 6300000	3680000 830000	460.00 1013.00
T30620	Machined	777.697 30.6180	889.000 35.0000	47.625 1.8750	3.3 0.13	3.3 0.13	11500000 2580000	442000 99300	45.71 100.79
D-2864-C	Pin	825.424 32.4970	1168.400 46.0000	127.000 5.0000	14.2 0.56	14.2 0.56	44100000 9920000	4040000 907000	549.70 1212.00
T45750	Machined	1162.050 45.7500	1282.700 50.5000	52.388 2.0625	3.3 0.13	3.3 0.13	19000000 4280000	618000 139000	79.69 175.66
F-3067-C	Machined	1219.998 48.0314	1574.869 62.0027	177.800 7.0000	6.4 0.25	6.4 0.25	49900000 11200000	5680000 1280000	1173.20 2587.00
T53250	Machined	1352.550 53.2500	1473.200 58.0000	52.375 2.0620	3.3 0.13	3.3 0.13	21100000 4750000	652000 146000	92.74 204.48
NP552714	Cageless	1549.999 61.0236	105.000 67.1260	60.000 2.3622	1.5 0.06	6.4 0.25	59400000 13400000	1600000 360000	149.16 328.85

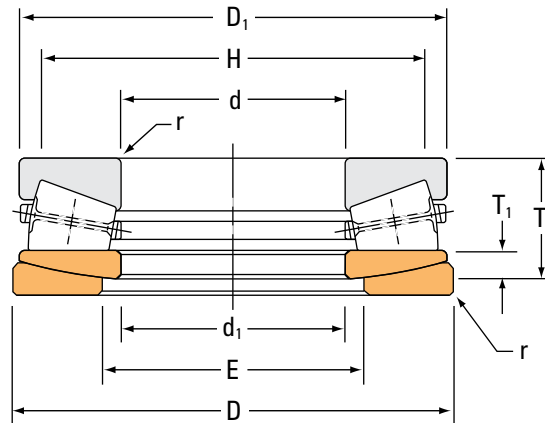
<sup>(1)</sup>Maximum shaft or housing fillet radius that bearing corners will clear.

<sup>(\*)</sup>Contact your Timken engineer for details.

# TAPERED ROLLER BEARINGS

THRUST • TYPE TTVS

## TYPE TTVS



Part Number	Dimensions									Ratings		Bearing Weight
	Bearing			Rings			Shoulder Dia.		Housing	Static	Dynamic	
Bearing	Bore	O.D.	Width	Thickness	Small Dia. O.D.	Large Bore I.D.	Housing Max.	Shaft Min.	Fillet <sup>(1)</sup> Radius Max.	C <sub>0</sub>	C <sub>a90</sub>	
	d	D	T	T <sub>1</sub>	D <sub>1</sub>	d <sub>1</sub>	E	H	r	N lbf	N lbf	kg lbs.
	mm in.	mm in.	mm in.	mm in.	mm in.	mm in.	mm in.	mm in.	mm in.			
B-7976-C	184.150 7.2500	406.400 16.0000	203.200 8.0000	66.680 2.6250	404.810 15.9380	187.320 7.3750	228.6 9.00	346.1 13.62	6.1 0.24	7650000 1720000	1180000 264000	157.40 347.00
B-8824-C	199.374 7.8730	399.948 15.7460	121.841 4.7969	36.400 1.4330	396.880 15.6250	203.200 8.0000	240.5 9.47	358.8 14.12	4.1 0.16	7020000 1580000	931000 209000	86.20 190.00
E-2004-C	228.600 9.0000	482.549 18.9980	158.750 6.2500	44.910 1.7680	479.550 18.8800	231.780 9.1250	282.6 11.12	419.1 16.50	4.8 0.19	10900000 2440000	1520000 342000	170.10 375.00
H-1685-C	241.300 9.5000	488.899 19.2480	152.400 6.0000	57.150 2.2500	482.600 19.0000	242.090 9.5310	279.4 11.00	431.8 17.00	6.1 0.24	9940000 2240000	1290000 290000	162.80 359.00
W-3120-C	253.975 9.9990	508.000 20.0000	215.900 8.5000	61.910 2.4370	504.820 19.8750	285.750 11.2500	317.5 12.50	425.4 16.75	10.2 0.40	9770000 2200000	1560000 350000	250.80 553.00
P-1739-C	304.800 12.0000	609.600 24.0000	215.900 8.5000	61.910 2.4370	608.010 23.9380	307.980 12.1250	349.2 13.75	536.6 21.12	7.6 0.30	17800000 4010000	2590000 586000	359.60 793.00
N-2827-G	355.600 14.0000	660.400 26.0000	254.000 10.0000	76.200 3.0000	657.220 25.8750	358.780 14.1250	412.8 16.25	577.8 22.75	10.2 0.40	18600000 4180000	2880000 646000	483.00 1065.00
B-8424-C	406.400 16.0000	869.950 34.2500	241.300 9.5000	82.550 3.2500	887.410 34.9380	438.150 17.2500	463.6 18.25	803.3 31.62	16.5 0.65	39000000 8770000	4590000 1030000	858.00 1892.00

<sup>(1)</sup>These maximum fillet radii will be cleared by the bearing corners.

TYPE TTSP

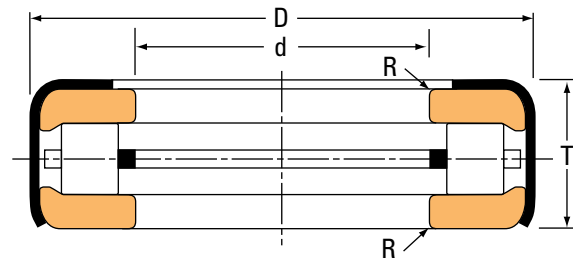


Fig. A.

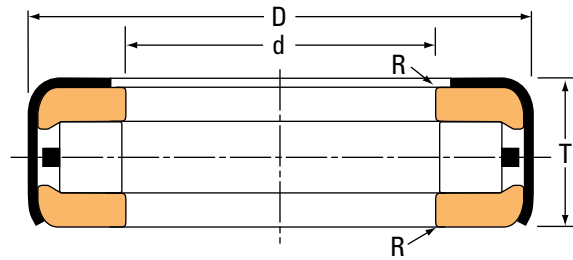


Fig. B.

Part Number		Fig.	Dimensions				Steering Pivot Rating	Bearing Weight	Remarks
No Oil Holes In Retainer	Oil Holes In Retainer		Bore	Outside Diameter	Width	Shaft Fillet Radius			
			d	D	T	R			
			mm in.	mm in.	mm in.	mm in.	N lbf	kg lbs.	
T63	T63W	A	16.129 0.6350	41.275 1.6250	12.700 0.5000	0.8 0.03	11100 2500	0.08 0.18	
T76	T76W	A	19.304 0.7600	41.275 1.6250	13.487 0.5310	0.8 0.03	11100 2500	0.08 0.18	
T77	T77W	A	19.304 0.7600	41.275 1.6250	12.700 0.5000	0.8 0.03	11100 2500	0.07 0.15	
T82	T82W	A	20.879 0.8220	41.275 1.6250	13.487 0.5310	0.8 0.03	11100 2500	0.07 0.15	
T86		A	20.257 0.7975	39.688 1.5625	14.288 0.5625	1.3 0.05	10700 2400	0.07 0.15	
T88	T88W	A	22.479 0.8850	48.021 1.8906	15.088 0.5940	0.8 0.03	17300 3890	0.11 0.24	
T89		A	22.479 0.8850	48.021 1.8906	15.875 0.6250	0.8 0.03	17350 3900	0.12 0.26	
T92		B	23.825 0.9380	44.958 1.7700	13.487 0.5310	0.8 0.03	11950 2690	* *	T92 has two bores, other bore = 24.054 mm (0.9470 in.)
T93		A	24.054 0.9470	44.958 1.7700	13.487 0.5310	0.8 0.03	11950 2690	0.09 0.2	
T94	T94W	A	24.054 0.9470	48.021 1.8906	15.088 0.5940	0.8 0.03	17350 3900	0.11 0.24	
T95	T95W	A	24.130 0.9500	50.800 2.0000	15.875 0.6250	0.8 0.03	18600 4200	0.13 0.29	
T101	T101W	A	25.654 1.0100	50.800 2.0000	15.875 0.6250	0.8 0.03	18600 4200	0.13 0.29	
T101X		A	25.146 0.9900	50.800 2.0000	15.875 0.6250	0.8 0.03	18600 4200	* *	T101X has two bores, other bore = 24.654 mm (1.0100 in.)

(\* )Contact your Timken engineer for details.

Continued on the next page.

# TAPERED ROLLER BEARINGS

THRUST • TYPE TTSP

## TYPE TTSP – continued

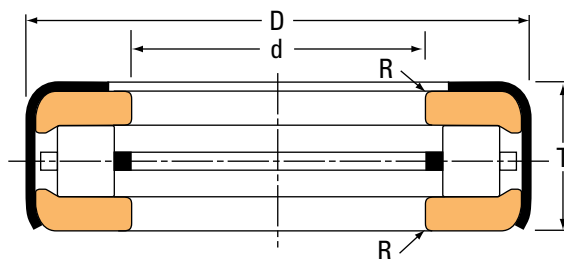


Fig. A.

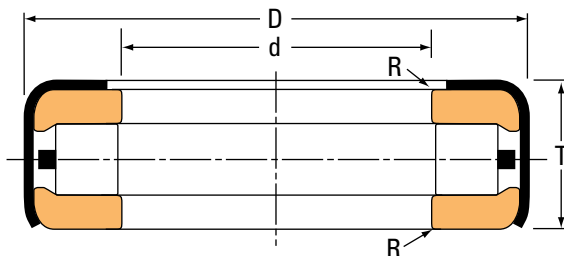


Fig. B.

Part Number		Fig.	Dimensions				Steering Pivot Rating	Bearing Weight	Remarks
No Oil Holes In Retainer	Oil Holes In Retainer		Bore	Outside Diameter	Width	Shaft Fillet Radius			
			d	D	T	R			
			mm in.	mm in.	mm in.	mm in.	N lbf	kg lbs.	
T102R		A	25.654 1.0100	50.800 2.0000	16.916 0.6660	0.8 0.03	18600 4200	* *	T102 has extended retainer. Contact Timken engineer for details.
T104	T104W	A	26.289 1.0350	50.800 2.0000	15.875 0.6250	0.8 0.03	18600 4200	0.13 0.29	
T105		A	25.654 1.0100	50.800 2.0000	15.875 0.6250	0.8 0.03	18600 4200	* *	T105 has two bores, other bore = 27.299 mm (1.0720 in.).
T107	T107W	A	27.299 1.0720	50.800 2.0000	15.875 0.6250	0.8 0.03	18600 4200	0.12 0.26	
T110	T110W	A	28.829 1.1350	53.188 2.0940	15.875 0.6250	0.8 0.03	20000 4500	0.14 0.31	
T113	T113W	A	28.829 1.1350	55.562 2.1875	15.875 0.6250	0.8 0.03	20000 4500	0.15 0.33	
T114	T114W	A	25.654 1.0100	55.562 2.1875	15.875 0.6250	0.8 0.03	20000 4500	* *	T114 and T114W have two bores, other bore = 28.829 mm (1.1350 in.).
T114X		B	28.829 1.1350	50.800 2.0000	15.875 0.6250	0.8 0.03	20000 4500	* *	T114X has two cages and two bores, other bore = 29.261 mm (1.1520 in.).
T119	T119W	A	30.416 1.1975	55.562 2.1875	15.875 0.6250	0.8 0.03	20000 4500	0.15 0.33	
T120		B	30.416 1.1975	54.745 2.1553	11.430 0.4500	0.8 0.03	16500 3710	0.11 0.24	
T121		A	30.716 1.2093	55.562 2.1875	15.875 0.6250	0.8 0.03	20000 4500	0.16 0.35	
T126	T126W	A	32.004 1.2600	55.562 2.1875	15.875 0.6250	0.8 0.03	20000 4500	0.14 0.31	
T126A	T126AW	A	32.004 1.2600	55.562 2.1875	15.875 0.6250	0.8 0.03	20000 4500	0.14 0.31	T126A - two cages.

(\*)Contact your Timken engineer for details.

Continued on the next page.



Part Number		Fig.	Dimensions				Steering Pivot Rating	Bearing Weight	Remarks
No Oil Holes In Retainer	Oil Holes In Retainer		Bore	Outside Diameter	Width	Shaft Fillet Radius			
			d	D	T	R			
			mm in.	mm in.	mm in.	mm in.	N lbf	kg lbs.	
T139	T139W	A	<b>35.179</b> 1.3850	<b>58.738</b> 2.3125	<b>15.875</b> 0.6250	<b>0.8</b> 0.03	<b>21400</b> 4800	<b>0.15</b> 0.33	
T139KP		A	<b>35.179</b> 1.3850	<b>58.738</b> 2.3125	<b>15.875</b> 0.6250	<b>0.8</b> 0.03	<b>21400</b> 4800	<b>0.15</b> 0.33	Races are cadmium plated.
T142	T142W	A	<b>35.179</b> 1.3850	<b>62.708</b> 2.4688	<b>19.431</b> 0.7650	<b>0.8</b> 0.03	<b>22400</b> 5050	<b>0.23</b> 0.51	
T149	T149W	A	<b>38.303</b> 1.5080	<b>65.883</b> 2.5938	<b>19.431</b> 0.7650	<b>0.8</b> 0.03	<b>23600</b> 5300	<b>0.24</b> 0.53	
T158		A	<b>40.234</b> 1.5840	<b>65.883</b> 2.5938	<b>19.431</b> 0.7650	<b>0.8</b> 0.03	<b>23600</b> 5300	<b>0.23</b> 0.51	
T199	T199W	A	<b>51.054</b> 2.0100	<b>74.612</b> 2.9375	<b>15.875</b> 0.6250	<b>0.8</b> 0.03	<b>26000</b> 5850	<b>0.2</b> 0.44	
T309	T309W	A	<b>78.583</b> 3.0938	<b>102.395</b> 4.0313	<b>15.875</b> 0.6250	<b>0.8</b> 0.03	<b>35400</b> 8000	<b>0.29</b> 0.64	
T387	T387W	A	<b>96.425</b> 3.8750	<b>127.000</b> 5.0000	<b>17.463</b> 0.7650	<b>0.8</b> 0.03	<b>43000</b> 9700	<b>0.5</b> 1.1	
T484		A	<b>123.012</b> 4.8430	<b>152.400</b> 6.0000	<b>17.463</b> 0.6875	<b>0.8</b> 0.03	<b>47500</b> 10600	<b>0.63</b> 1.39	
T581		A	<b>147.638</b> 5.8125	<b>177.800</b> 7.0000	<b>17.463</b> 0.6875	<b>0.8</b> 0.03	<b>51500</b> 11600	<b>0.89</b> 1.96	
T1760		SPCL <sup>(1)</sup>	<b>44.623</b> 1.7568	<b>76.200</b> 3.0000	<b>10.922</b> 0.4300	<b>0.8</b> 0.03	<b>31600</b> 7100	<b>0.18</b> 0.4	

<sup>(1)</sup>SPCL = special, not shown.

### TYPE TTC, TTCS, TTCL



TTC



TTCS



TTCL

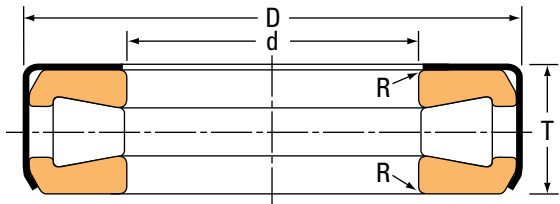


Fig. C. Type TTC.

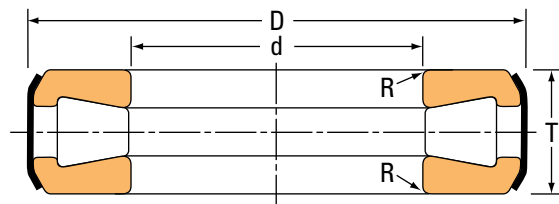


Fig. D. Type TTCS.

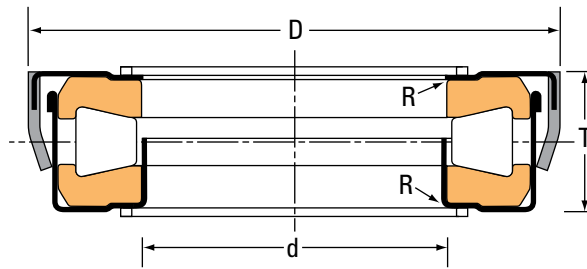


Fig. E. Type TTCL.

Part Number		Fig.	Dimensions				Steering Pivot Rating	Bearing Weight	Remarks
No Oil Holes In Retainer	Oil Holes In Retainer		Bore	Outside Diameter	Width	Shaft Fillet Radius			
			d	D	T	R			
			mm in.	mm in.	mm in.	mm in.	N lbf	kg lbs.	
T127	T127W	C	32.004 1.2600	66.675 2.6250	19.446 0.7656	0.8 0.03	42200 9450	0.31 0.68	
T128		D	32.004 1.2600	66.675 2.6250	18.654 0.7344	0.8 0.03	42200 9450	0.29 0.64	
T130		C	27.102 1.0670	66.675 2.6250	19.446 0.7656	0.8 0.03	42200 9450	0.34 0.75	
T136		D	35.179 1.3850	66.675 2.6250	18.654 0.7344	0.8 0.03	42200 9450	0.28 0.62	
T138	T138W	C	35.179 1.3850	66.675 2.6250	19.446 0.7656	0.8 0.03	42200 9450	0.30 0.66	
T138XS		SPCL <sup>(1)</sup>	35.179 1.3850	66.675 2.6250	19.446 0.7656	0.8 0.03	42200 9450	* *	T138XS has two bores, other bore = 35.387 mm (1.3972 in.).

<sup>(1)</sup>SPCL = special, not shown.

<sup>(\*)</sup>Contact your Timken engineer for details.

Continued on the next page.

Part Number			Dimensions				Steering Pivot Rating	Bearing Weight	Remarks
No Oil Holes In Retainer	Oil Holes In Retainer	Fig.	Bore  d	Outside Diameter  D	Width  T	Shaft Fillet Radius  R			
			mm in.	mm in.	mm in.	mm in.	N lbf	kg lbs.	
T144	T144W	C	36.754 1.4470	66.675 2.6250	19.446 0.7656	1.5 0.06	42200 9450	0.29 0.64	
T144XA		SPCL <sup>(1)</sup>	36.754 1.4470	66.675 2.6250	19.446 0.7656	1.5 0.06	42200 9450	* *	T144XA has two bores, other bore = 37.137 mm (1.4621 in.).
T151	T151W	C	38.354 1.5100	72.619 2.8590	21.433 0.8438	0.8 0.03	47000 10600	0.37 0.82	
T152		D	38.354 1.5100	72.619 2.8590	20.638 0.8125	0.8 0.03	47000 10600	0.35 0.77	
T157	T157W	C	39.954 1.5730	72.619 2.8590	21.433 0.8438	0.8 0.03	47000 10600	0.37 0.82	
T163	T163W	C	41.529 1.6350	72.619 2.8590	21.433 0.8438	0.8 0.03	47000 10600	0.35 0.77	
T163X	T163XW	C	41.529 1.6350	72.619 2.8590	21.433 0.8438	2.0 0.80	47000 10600	0.35 0.77	
T169	T169W	C	43.104 1.6970	82.956 3.2660	23.812 0.9375	0.8 0.03	64000 14300	0.55 1.21	
T176	T176W	C	44.704 1.7600	82.956 3.2660	23.812 0.9375	0.8 0.03	64000 14300	0.54 1.19	
T177		C	45.000 1.7717	73.000 2.8740	20.000 0.7874	0.8 0.03	47500 10700	0.32 0.71	
T177A		C	45.484 1.7907	73.000 2.8740	20.000 0.7874	0.8 0.03	47500 10700	0.33 0.73	
T177XA		SPCL <sup>(1)</sup>	45.000 1.7717	73.127 2.8790	20.000 0.7874	0.8 0.03	47500 10700	* *	T177XA has two bores, other = 45.484 mm (1.7907 in.).
T177S		E	45.000 1.7717	74.500 2.9331	20.221 0.7961	0.8 0.03	47500 10700	0.35 0.77	
T178		C	40.401 1.5906	73.000 2.8740	19.000 0.7480	0.8 0.03	47500 10700	* *	
T182	T182W	C	46.279 1.8220	82.956 3.2660	23.812 0.9375	0.8 0.03	64000 14300	0.52 1.15	
T188	T188W	C	47.879 1.8850	82.956 3.2660	23.812 0.9375	0.8 0.03	64000 14300	0.52 1.15	
T189	T189W	D	47.879 1.8850	82.956 3.2660	23.020 0.9063	0.8 0.03	64000 14300	0.50 1.10	
T193	T193W	D	49.454 1.9470	93.269 3.6720	26.187 1.0310	0.8 0.03	86000 19400	0.80 1.76	
T194	T194W	C	49.454 1.9470	93.269 3.6720	26.975 1.0620	0.8 0.03	86000 19400	0.81 1.79	
T201	T201W	D	51.054 2.0100	93.269 3.6720	26.187 1.0310	3.3 0.13	86000 19400	0.77 1.70	
T202	T202W	C	51.054 2.0100	93.269 3.6720	26.975 1.0620	3.3 0.13	86000 19400	0.80 1.76	
T208	T208W	C	52.629 2.0720	93.269 3.6720	26.975 1.0620	0.8 0.03	86000 19400	0.79 1.74	

<sup>(1)</sup>SPCL = special, not shown.

<sup>(\*)</sup>Contact your Timken engineer for details.

Continued on the next page.

# TAPERED ROLLER BEARINGS

THRUST • TYPE TTC, TTCS, TTCL

## TYPE TTC, TTCS, TTCL – continued

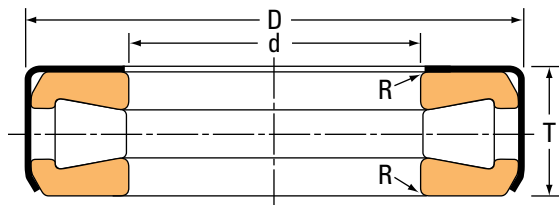


Fig. C. Type TTC.

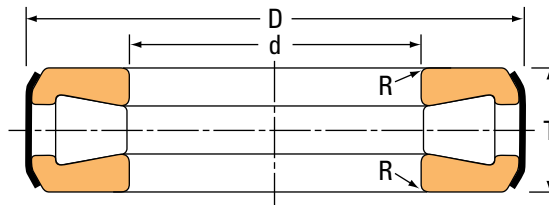


Fig. D. Type TTCS.

Part Number		Fig.	Dimensions				Steering Pivot Rating	Bearing Weight	Remarks
No Oil Holes In Retainer	Oil Holes In Retainer		Bore	Outside Diameter	Width	Shaft Fillet Radius			
			d	D	T	R			
			mm in.	mm in.	mm in.	mm in.	N lbf	kg lbs.	
T209	T209W	D	<b>52.629</b> 2.0720	<b>93.269</b> 3.6720	<b>26.187</b> 1.0310	<b>0.8</b> 0.03	<b>86000</b> 19400	<b>0.75</b> 1.65	
T251	T251W	C	<b>63.754</b> 2.5100	<b>111.125</b> 4.3750	<b>26.988</b> 1.0625	<b>0.8</b> 0.03	<b>124000</b> 27900	<b>1.07</b> 2.36	
T252	T252W	D	<b>63.754</b> 2.5100	<b>111.125</b> 4.3750	<b>25.796</b> 1.0156	<b>0.8</b> 0.03	<b>124000</b> 27900	<b>1.07</b> 2.23	
T301	T301W	D	<b>76.454</b> 3.0100	<b>133.350</b> 5.2500	<b>33.338</b> 1.3125	<b>2.3</b> 0.09	<b>178500</b> 40000	<b>1.87</b> 4.12	
T302	T302W	C	<b>76.454</b> 3.0100	<b>133.350</b> 5.2500	<b>34.925</b> 1.3750	<b>2.3</b> 0.09	<b>178500</b> 40000	<b>1.99</b> 4.39	
T350		D	<b>88.900</b> 3.5000	<b>133.350</b> 5.2500	<b>33.335</b> 1.3124	<b>2.8</b> 0.11	<b>115500</b> 26000	<b>1.41</b> 3.11	
T402	T402W	D	<b>102.108</b> 4.0200	<b>179.619</b> 7.0716	<b>44.450</b> 1.7500	<b>1.5</b> 0.06	<b>344000</b> 77500	<b>4.84</b> 10.67	
T600	T600W	C	<b>152.400</b> 8.0000	<b>241.300</b> 9.5000	<b>76.200</b> 3.0000	<b>3.3</b> 0.13	<b>575000</b> 129000	<b>14.10</b> 31.09	
T1260	T1260W	C	<b>32.004</b> 1.2600	<b>55.562</b> 2.1875	<b>15.875</b> 0.6250	<b>0.8</b> 0.03	<b>27600</b> 6200	<b>0.17</b> 0.37	
T1380		SPCL <sup>(1)</sup>	<b>35.179</b> 1.3850	<b>59.400</b> 2.3386	<b>15.875</b> 0.6250	<b>0.8</b> 0.03	<b>31200</b> 7000	<b>0.35</b> 0.77	Two-piece seal.
T1921		C	<b>46.279</b> 1.8220	<b>80.010</b> 3.1500	<b>15.977</b> 0.6290	<b>0.8</b> 0.03	<b>56500</b> 12700	<b>0.34</b> 0.75	
T4020		D	<b>102.108</b> 4.0200	<b>179.619</b> 7.0716	<b>31.750</b> 1.2500	<b>1.5</b> 0.06	<b>324000</b> 73000	<b>3.70</b> 8.16	

<sup>(1)</sup>SPCL = special, not shown.

<sup>(\*)</sup>Contact your Timken engineer for details.

## ***AUXILIARY PARTS***

Timken offers a wide range of auxiliary parts for use in the mounting of bearing products. Locknuts, lockwashers and shims may be used to help ensure the proper backing and setting of bearings in the application.



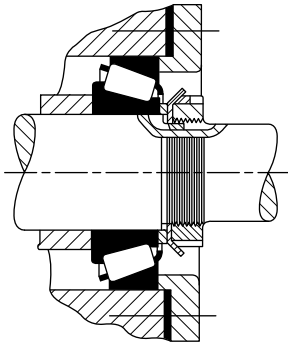
**AUXILIARY PARTS****STANDARD LOCKNUTS, LOCKWASHERS AND TONGUED WASHER ASSEMBLIES**

Fig. 43

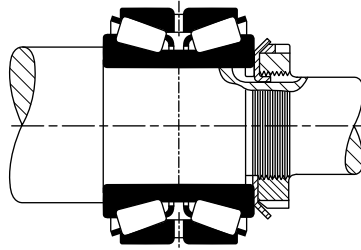


Fig. 44

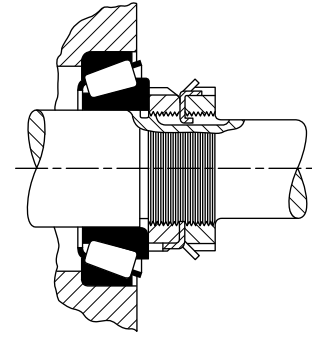


Fig. 45

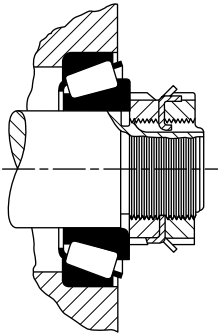


Fig. 46

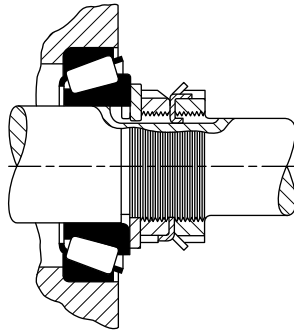


Fig. 47

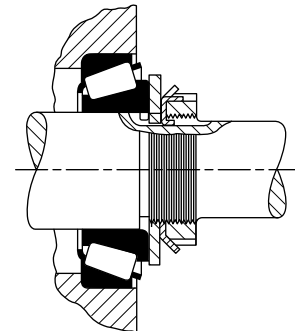


Fig. 48

The designs shown in figs. 43 to 48 show various methods of applying standard locknuts, lockwashers and tongued washers. A single locknut and lockwasher can be used to clamp the inner ring against a sleeve, shown in fig. 43, or directly against a shaft shoulder. A narrow spacer is applied between the front face of the inner ring and the lockwasher so that the lockwasher will clear the bearing cage by a minimum of 3 mm (0.12 in.). The spacer outside diameter should be made a minimum of 6 mm (0.24 in.) smaller than the cage inside diameter, but must still provide the suggested inner ring backing diameter. Fig. 44 shows another clamped design using a single locknut and lockwasher with a double-row bearing of either type TDO with inner ring spacer or type TNA. Since no cage clearance problem is present, the narrow spacer shown in fig. 43 is unnecessary.

Fig. 45, 46, and 47 indicate an adjustable bearing arrangement using two locknuts and a lockwasher. These may be used with either single- or double-row bearings of the types permitting an inner ring adjusted arrangement. The design in fig. 45 allows the maximum shaft extension diameter that can be used with a

shaft thread outside diameter, which will be less than the inner ring bore. Fig. 46 shows an alternate design with smaller thread diameter and corresponding smaller locknuts and lockwasher. The locknut outside diameter, minus two times  $r$ , must not be less than the suggested inner ring backing diameter. Fig. 47 indicates the use of a tongued washer located between the inner locknut and inner ring. This is intended for applications where the inner rings are applied with loose fits on hardened stationary shafts as found in many automotive applications. The hardened tongued washers are not sold by The Timken Company.

When space does not permit the use of two locknuts and a lockwasher in an adjustable arrangement, and a single locknut and a lockwasher are used, then a tongued washer must be placed between the inner ring and lockwasher as illustrated in fig. 48. This is necessary to provide adequate backing for the inner ring, in most cases, and to prevent damage to the lockwasher if the inner ring should creep on the shaft. The tongued washers are available from The Timken Company.

STANDARD LOCKNUTS, LOCKWASHERS AND TONGUED WASHERS – METRIC

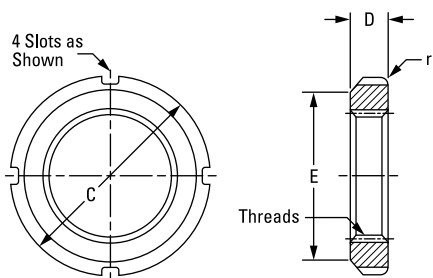


Fig. 49. Locknuts (threads are ISO 965/1, class 5H).

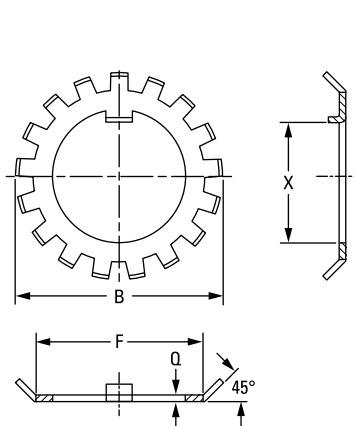


Fig. 50. Lockwashers.

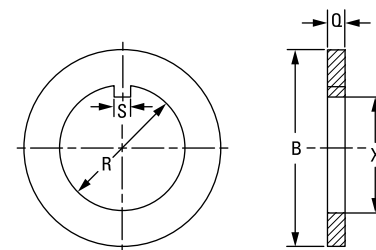


Fig. 51. Tongued washers.

ABMA Locknut Number	Locknut Dimensions					Lockwasher Dimensions					Tongued Washer Dimensions							
	Threads		Outside Dia. C	Thick-ness D	Free Outside Dia. E	Corner Radius r	ABMA Lockwasher Number	Max. Dia. Over Tangs B	Face Dia. F	Thick-ness Q	No. of Tangs	Tongued Washer Number	Bore		Outside Dia. B	Thick-ness Q	Key	
	Min. Value of Major Dia.	Thread Sizes											Min. R	Max. R			Max. S	Min. X
mm	mm	mm	mm	mm	mm	mm	mm	mm	mm	mm	mm	mm	mm	mm	mm	mm	mm	
KMH2	15.000	M15X1	25.000	8.000	21.000	1.17	MBB2	28.000	21.000	1.41	11	MW2	15.095	15.205	22.000	3.25	4.0	12.195
KMH3	17.000	M17X1	28.000	8.000	24.000	1.17	MBB3	32.000	24.000	1.41	11	MW3	17.095	17.205	24.000	3.25	4.0	14.195
KMH4	20.000	M20X1	32.000	9.000	26.000	1.17	MBB4	36.000	26.000	1.41	11	MW4	20.110	20.240	29.000	3.25	4.0	17.295
KMH4.4	22.000	M22X1	34.000	9.000	28.000	1.17	MBB4.4	38.000	28.000	1.41	11	MW4.4	22.110	22.240	31.000	3.25	4.0	19.710
KMH5	25.000	M25X1.5	38.000	10.000	32.000	1.17	MBB5	42.000	32.000	1.41	13	MW5	25.110	25.240	40.000	3.25	5.0	21.910
KMH5.6	28.000	M28X1.5	42.000	10.000	36.000	1.17	MBB5.6	46.000	36.000	1.41	13	MW5.6	28.110	28.240	40.000	3.25	5.0	24.910
KMH6	30.000	M30X1.5	45.000	10.000	38.000	1.17	MBB6	49.000	38.000	1.41	13	MW6	30.110	30.240	45.000	3.25	5.0	26.910
KMH6.4	32.000	M32X1.5	48.000	11.000	40.000	1.59	MBB6.4	52.000	40.000	1.41	13	MW6.4	32.120	32.280	50.000	3.25	5.0	29.010
KMH7	35.000	M35X1.5	52.000	11.000	44.000	1.59	MBB7	57.000	44.000	1.41	13	MW7	35.120	35.280	52.000	3.25	6.0	31.820
KMH8	40.000	M40X1.5	58.000	11.000	50.000	1.59	MBB8	62.000	50.000	1.78	13	MW8	40.120	40.280	57.000	4.20	6.0	36.520
KMH9	45.000	M45X1.5	65.000	12.000	56.000	1.59	MBB9	69.000	56.000	1.78	13	MW9	45.130	45.290	68.000	4.20	6.0	41.530
KMH10	50.000	M50X1.5	70.000	13.000	61.000	1.59	MBB10	74.000	61.000	1.78	13	MW10	50.130	50.290	76.000	4.20	6.0	46.530
KMH11	55.000	M55X2	75.000	13.000	67.000	1.59	MBB11	81.000	67.000	1.78	17	MW11	55.140	55.330	79.000	4.20	8.0	51.140
KMH12	60.000	M60X2	80.000	14.000	73.000	1.59	MBB12	86.000	73.000	1.78	17	MW12	60.140	60.330	88.000	4.70	8.0	55.940
KMH13	65.000	M65X2	85.000	14.000	79.000	2.38	MBB13	92.000	79.000	1.78	17	MW13	65.140	65.330	90.000	4.70	8.0	60.940
KMH14	70.000	M70X2	92.000	14.000	85.000	2.38	MBB14	98.000	85.000	1.78	17	MW14	70.150	70.340	103.000	4.70	8.0	65.950
KMH15	75.000	M75X2	98.000	15.000	90.000	2.38	MBB15	104.000	90.000	2.24	17	MW15	75.150	75.340	103.000	5.70	8.0	70.550
KM16	80.000	M80X2	105.000	15.000	95.000	2.38	MBB16	112.000	95.000	2.24	17	MW16	80.150	80.340	111.000	5.70	10.0	75.150
KM17	85.000	M85X2	110.000	16.000	102.000	2.38	MBB17	119.000	102.000	2.24	17	MW17	85.170	85.390	116.000	5.70	10.0	80.150
KM18	90.000	M90X2	120.000	16.000	108.000	2.38	MBB18	126.000	108.000	2.73	17	MW18	90.170	90.390	121.000	7.62	10.0	84.670
KM19	95.000	M95X2	125.000	17.000	113.000	3.18	MBB19	133.000	113.000	2.73	17	MW19	95.170	95.390	126.000	7.62	10.0	89.670
KM20	100.000	M100X2	130.000	18.000	120.000	3.18	MBB20	142.000	120.000	2.73	17	MW20	100.170	100.390	131.000	7.62	12.0	94.670
KM21	105.000	M105X2	140.000	18.000	126.000	3.18	MBB21	145.000	126.000	2.73	17	MW21	105.180	105.400	125.000	7.62	12.0	99.670
KM22	110.000	M110X2	145.000	19.000	133.000	3.18	MBB22	154.000	133.000	3.25	17	MW22	110.180	110.400	136.000	7.62	12.0	104.180
KM23	115.000	M115X2	150.000	19.000	137.000	3.18	MBB23	159.000	137.000	3.25	17	MW23	115.180	115.400	144.000	7.62	12.0	109.180
KM24	120.000	M120X2	155.000	20.000	138.000	3.18	MBB24	164.000	138.000	3.72	17	MW24	120.180	120.400	150.000	9.57	14.0	113.180
KM25	125.000	M125X2	160.000	21.000	148.000	3.18	MBB25	170.000	148.000	3.72	17	MW25	125.200	125.450	138.000	9.57	14.0	118.180
KM26	130.000	M130X2	165.000	21.000	149.000	3.18	MBB26	175.000	149.000	3.72	17	MW26	130.200	130.450	166.000	9.57	14.0	123.200

STANDARD LOCKNUTS, LOCKWASHERS AND TONGUED WASHERS – INCH

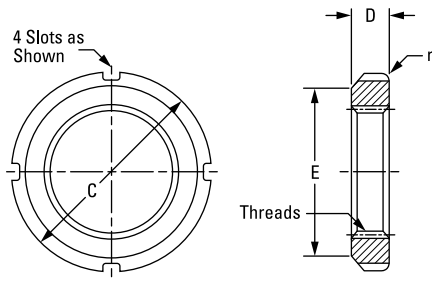


Fig. 52. Locknuts (threads are ISO 965/1, class 5H).

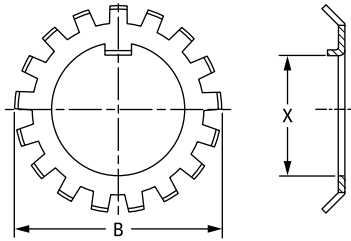


Fig. 53. Lockwashers.

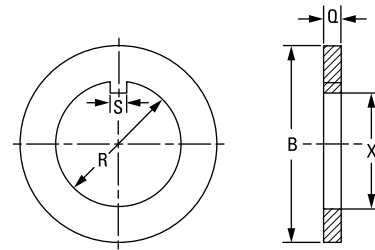


Fig. 54. Tongued washers.

Threads are American National, Form NS, Class 3, with thread length based on 45° chamfer.

ABMA Locknut Number	Locknut Dimensions						Lockwasher Dimensions					Tongued Washer Dimensions						
	Threads		Outside Dia. C	Thick-ness D	Free Outside Dia. E	Corner Radius r	ABMA Lockwasher Number	Max. Dia. Over Tangs B	Face Dia. F	Thick-ness Q	No. of Tangs	Tongued Washer Number	Bore		Outside Dia. B	Thick-ness Q	Key	
	Min. Value of Major Dia.	Thread Sizes											Min. R	Max. R			Max. S	Min. X
in.	in.	in.	in.	in.	in.	in.	in.	in.	in.	in.	in.	in.	in.	in.	in.	in.	in.	
N-00	0.391	32	0.755	0.229	0.625	0.047	TW100	0.891	0.625	0.032	9	K91500	0.406	0.421	0.798	0.109	0.120	0.334
N-01	0.469	32	0.880	0.323	0.719	0.047	TW101	1.031	0.719	0.032	9	K91501	0.484	0.499	0.923	0.109	0.120	0.412
N-02	0.586	32	1.005	0.323	0.813	0.047	TW102	1.156	0.813	0.048	11	K91502	0.601	0.616	1.173	0.125	0.120	0.513
N-03	0.664	32	1.130	0.354	0.938	0.047	TW103	1.344	0.938	0.048	11	K91503	0.679	0.694	1.173	0.125	0.120	0.591
N-04	0.781	32	1.380	0.385	1.125	0.047	TW104	1.563	1.125	0.052	11	K91504	0.801	0.816	1.423	0.125	0.176	0.713
N-05	0.969	32	1.568	0.416	1.281	0.047	TW105	1.703	1.281	0.052	13	K91505	0.989	1.009	1.860	0.125	0.176	0.897
N-06	1.173	18	1.755	0.416	1.500	0.047	TW106	1.953	1.500	0.052	13	K91506	1.193	1.213	1.860	0.125	0.176	1.081
TN-065	1.312	18	2.068	0.448	1.813	0.063	TW065	2.234	1.813	0.052	15	K915065	1.333	1.353	2.173	0.125	0.176	1.221
TN-07	1.376	18	2.068	0.448	1.813	0.063	TW107	2.250	1.813	0.052	15	K91507	1.396	1.416	2.173	0.125	0.176	1.284
TN-08	1.563	18	2.255	0.448	2.000	0.063	TW108	2.484	2.000	0.062	15	K91508	1.583	1.603	2.735	0.156	0.290	1.461
TN-09	1.767	18	2.536	0.448	2.281	0.063	TW109	2.719	2.281	0.062	17	K91509	1.792	1.817	2.735	0.156	0.290	1.670
TN-10	1.967	18	2.693	0.510	2.438	0.063	TW110	2.922	2.438	0.062	17	K91510	1.992	2.017	3.235	0.156	0.290	1.870
TN-11	2.157	18	2.974	0.510	2.656	0.063	TW111	3.094	2.656	0.062	17	K91511	2.182	2.207	3.235	0.156	0.290	2.060
TN-12	2.360	18	3.161	0.541	2.844	0.063	TW112	3.328	2.844	0.072	17	K91512	2.400	2.425	3.735	0.187	0.290	2.248
TN-13	2.548	18	3.380	0.573	3.063	0.094	TW113	3.563	3.063	0.072	19	K91513	2.588	2.613	3.735	0.187	0.290	2.436
TN-14	2.751	18	3.360	0.573	3.313	0.094	TW114	3.813	3.313	0.072	19	K91514	2.791	2.816	3.735	0.187	0.290	2.639
TAN-15	2.933	12	3.880	0.604	3.563	0.094	TW115	4.047	3.563	0.085	19	K91515	2.973	3.003	4.173	0.218	0.290	2.808
TAN-16	3.137	12	4.161	0.604	3.844	0.094	TW116	4.391	3.844	0.085	19	K91516	3.177	3.207	4.173	0.218	0.353	3.012
TAN-17	3.340	12	4.411	0.635	4.031	0.094	TW117	4.625	4.031	0.085	19	K91517	3.395	3.425	4.610	0.218	0.353	3.230
TAN-18	3.527	12	4.661	0.698	4.281	0.094	TW118	4.953	4.281	0.115	19	K91518	3.582	3.612	5.110	0.250	0.353	3.387
TAN-19	3.730	12	4.943	0.729	4.563	0.125	TW119	5.234	4.563	0.115	19	K91519	3.800	3.830	5.110	0.250	0.353	3.605
TAN-20	3.918	12	5.193	0.760	4.813	0.125	TW120	5.484	4.813	0.115	19	K91520	3.988	4.018	5.610	0.250	0.353	3.778
TAN-21	4.122	12	5.443	0.760	5.000	0.125	TW121	5.703	5.000	0.115	19	K91521	4.192	4.222	5.610	0.250	0.353	3.982
TAN-22	4.325	12	5.724	0.791	5.281	0.125	TW122	6.000	5.281	0.130	19	K91522	4.395	4.425	6.110	0.281	0.353	4.170
TAN-24	4.716	12	6.130	0.823	5.688	0.125	TW124	6.531	5.688	0.155	19	K91524	4.801	4.831	6.735	0.375	0.353	4.551
TAN-26	5.106	12	6.755	0.885	6.188	0.125	TW126	7.047	6.188	0.155	19	K91526	5.191	5.226	7.485	0.375	0.435	4.921
TAN-128	5.497	12	7.099	1.198	6.531	0.125	TW128	7.438	6.531	0.155	19	K91528	5.582	5.617	7.485	0.375	0.590	5.312
TAN-130	5.888	12	7.693	1.260	7.063	0.125	TW130	8.063	7.063	0.193	19	K91530	5.983	6.018	7.985	0.375	0.590	5.675
TAN-132	6.284	8	8.068	1.291	7.438	0.156	TW132	8.453	7.438	0.193	19	K91532	6.389	6.424	8.485	0.375	0.590	6.081
TAN-134	6.659	8	8.661	1.354	8.031	0.156	TW134	9.078	8.031	0.193	19	K91534	6.764	6.799	8.985	0.375	0.715	6.456
TAN-136	7.066	8	9.068	1.416	8.375	0.156	TW136	9.438	8.375	0.193	19	K91536	7.171	7.206	9.235	0.375	0.715	6.863
TAN-138	7.472	8	9.474	1.416	8.781	0.156	TW138	9.859	8.781	0.193	19	K91538	7.577	7.612	9.735	0.375	0.715	7.269
TAN-140	7.847	8	9.849	1.510	9.156	0.156	TW140	10.406	9.156	0.193	19	K91540	7.982	8.017	10.110	0.375	0.840	7.674



### SHAFT THREAD AND KEYWAY DIMENSIONS FOR STANDARD LOCKNUTS, LOCKWASHERS AND TONGUED WASHERS

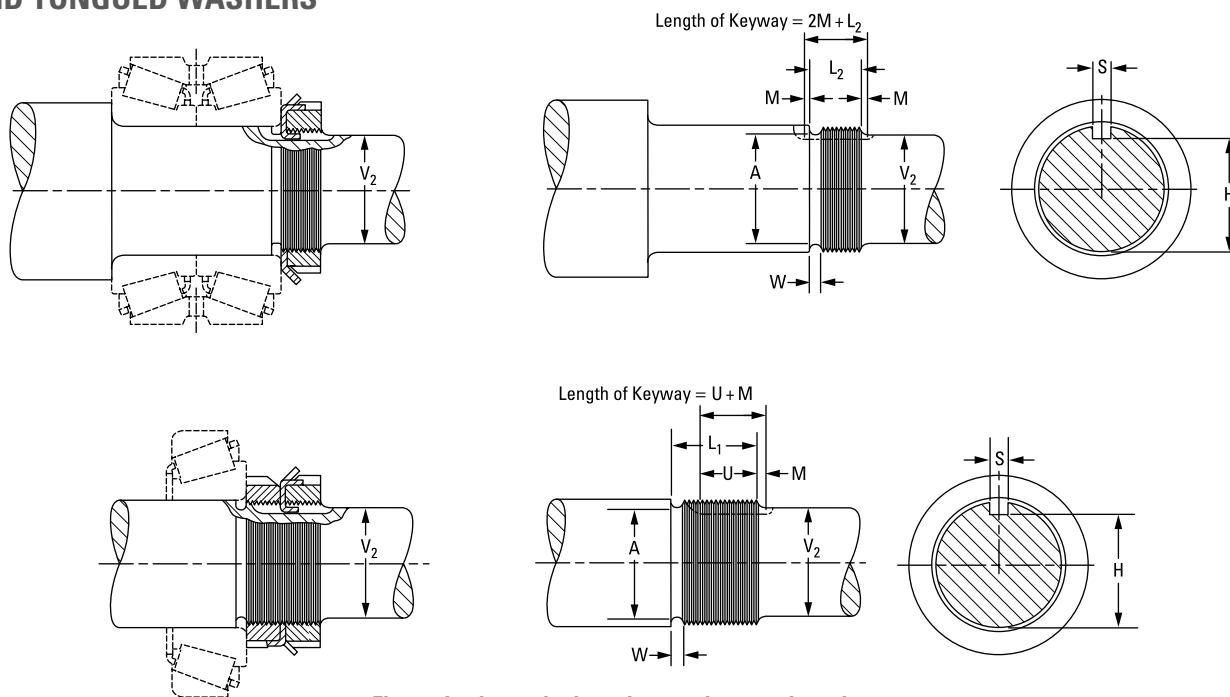


Fig. 55. Locknuts, lockwashers and tongued washers.

These dimensions are ABMA standards.

ABMA Locknut Number	Number Per Inch	Threads									Shaft Ext. Dia. V <sub>2</sub> Max.	Thread Length		Keyway			
		Major Diameter			Pitch Diameter <sup>(1)</sup>			Minor Diameter	Relief Diameter	Relief Width +0.016/0.000		+0.016	+0.016	Depth Max.	Width		
		Max.	Tol.	Min.	Max.	Tol.	Min.	Max.	A	W		L <sub>1</sub>	L <sub>2</sub>	H	S <sup>(2)</sup>	M <sup>(2)</sup>	U <sup>(2)</sup>
in.	in.	in.	in.	in.	in.	in.	in.	in.	in.	in.	in.	in.	in.	in.	in.	in.	
N-00	32	0.391	0.0054	0.3856	0.3707	0.0026	0.3681	0.3257	0.3371 ± 0.005	0.062	0.312	0.593	0.375	0.287	0.125	0.094	0.469
N-01	32	0.469	0.0054	0.4636	0.4487	0.0026	0.4461	0.4307	0.4151 ± 0.005	0.062	0.406	0.781	0.468	0.366	0.125	0.094	0.562
N-02	32	0.586	0.0054	0.5806	0.5657	0.0030	0.5627	0.5477	0.5321 ± 0.005	0.062	0.500	0.812	0.500	0.485	0.125	0.094	0.594
N-03	32	0.664	0.0054	0.6586	0.6437	0.0030	0.6407	0.6257	0.6101 ± 0.005	0.062	0.562	0.875	0.531	0.564	0.125	0.094	0.625
N-04	32	0.781	0.0054	0.7756	0.7607	0.0034	0.7573	0.7427	0.7271 ± 0.005	0.062	0.703	0.906	0.531	0.676	0.188	0.094	0.625
N-05	32	0.969	0.0054	0.9636	0.9487	0.0034	0.9453	0.9307	0.9151 ± 0.005	0.062	0.875	1.000	0.593	0.835	0.188	0.125	0.719
N-06	18	1.173	0.0082	1.1648	1.1369	0.0040	1.1329	1.1048	1.0892 ± 0.005	0.093	1.062	1.000	0.593	1.040	0.188	0.125	0.719
TN-065	18	1.312	0.0082	1.3043	1.2764	0.0040	1.2724	1.2443	1.2287 ± 0.005	0.093	1.188	1.062	0.625	1.180	0.188	0.125	0.750
TN-07	18	1.376	0.0082	1.3678	1.3399	0.0040	1.3359	1.3078	1.2922 ± 0.005	0.093	1.250	1.062	0.625	1.244	0.188	0.125	0.750
TN-08	18	1.563	0.0082	1.5548	1.5269	0.0045	1.5224	1.4948	1.4792 ± 0.005	0.093	1.438	1.062	0.625	1.422	0.312	0.125	0.750
TN-09	18	1.767	0.0082	1.7588	1.7309	0.0045	1.7264	1.6988	1.6832 ± 0.005	0.125	1.656	1.062	0.625	1.628	0.312	0.156	0.781
TN-10	18	1.967	0.0082	1.9588	1.9309	0.0045	1.9264	1.8988	1.8832 ± 0.005	0.125	1.859	1.187	0.687	1.830	0.312	0.156	0.844
TN-11	18	2.157	0.0082	2.1488	2.1209	0.0051	2.1158	2.0888	2.0732 ± 0.005	0.125	2.047	1.187	0.687	2.021	0.312	0.156	0.844
TN-12	18	2.360	0.0082	2.3518	2.3239	0.0051	2.3188	2.2918	2.2762 ± 0.005	0.125	2.250	1.281	0.750	2.194	0.312	0.156	0.906
TN-13	18	2.548	0.0082	2.5398	2.5119	0.0051	2.5068	2.4798	2.4642 ± 0.005	0.125	2.422	1.343	0.781	2.382	0.312	0.156	0.938
TN-14	18	2.751	0.0082	2.7428	2.7149	0.0051	2.7098	2.6828	2.6672 ± 0.005	0.125	2.625	1.343	0.781	2.586	0.312	0.250	1.000
TAN-15	12	2.933	0.0112	2.9218	2.8789	0.0054	2.8735	2.8308	2.7995 ± 0.010	0.156	2.781	1.406	0.812	2.737	0.312	0.250	1.031

<sup>(1)</sup>This standard is applicable to steel nuts. When either the nut or the shaft is made of stainless steel, aluminum, or other material having a tendency to seize, it is recommended that the maximum thread diameter of the shaft, both major and pitch, be reduced by 20 percent of the listed pitch diameter tolerance.

<sup>(2)</sup>Suggested tolerance on these dimensions of +0.016/-0.000 in.

Continued on next page.

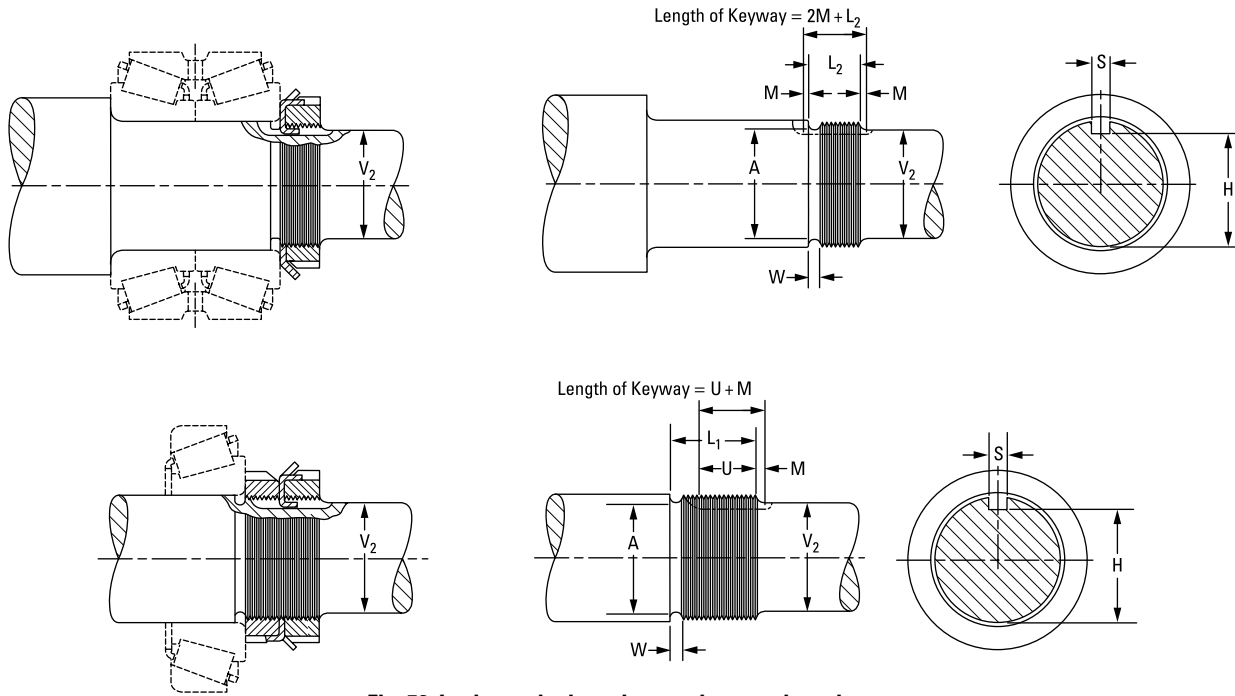


Fig. 56. Locknuts, lockwashers and tongued washers.

These dimensions are ABMA standards.

ABMA Locknut Number	Number Per Inch	Threads									Shaft Ext. Dia. V <sub>2</sub> Max.	Thread Length		Keyway			
		Major Diameter			Pitch Diameter <sup>(1)</sup>			Minor Diameter	Relief Diameter	Relief Width +0.016 0.000		+0.016 -0.000	+0.016 -0.000	Depth Max.	Width		
		Max.	Tol.	Min.	Max.	Tol.	Min.	Max.	A	W		L <sub>1</sub>	L <sub>2</sub>	H	S <sup>(2)</sup>	M <sup>(2)</sup>	U <sup>(2)</sup>
in.	in.	in.	in.	in.	in.	in.	in.	in.	in.	in.	in.	in.	in.	in.	in.	in.	
TAN-16	12	3.137	0.0112	3.1258	3.0829	0.0059	3.0770	3.0348	3.0035 ± 0.010	0.156	3.000	1.406	0.812	2.938	0.375	0.250	1.031
TAN-17	12	3.340	0.0112	3.3288	3.2859	0.0059	3.2800	3.2378	3.2065 ± 0.010	0.156	3.188	1.468	0.843	3.141	0.375	0.250	1.062
TAN-18	12	3.527	0.0112	3.5158	3.4729	0.0074	3.4655	3.4248	3.3935 ± 0.010	0.156	3.375	1.625	0.937	3.298	0.375	0.250	1.156
TAN-19	12	3.730	0.0112	3.7188	3.6759	0.0074	3.6685	3.6278	3.5965 ± 0.010	0.156	3.562	1.687	0.968	3.502	0.375	0.250	1.188
TAN-20	12	3.918	0.0112	3.9068	3.8639	0.0074	3.8565	3.8158	3.7845 ± 0.010	0.156	3.766	1.750	1.000	3.690	0.375	0.312	1.281
TAN-21	12	4.122	0.0112	4.1108	4.0679	0.0083	4.0596	4.0198	3.9885 ± 0.010	0.156	3.938	1.750	1.000	3.894	0.375	0.312	1.281
TAN-22	12	4.325	0.0112	4.3138	4.2709	0.0083	4.2626	4.2228	4.1915 ± 0.010	0.156	4.156	1.812	1.031	4.098	0.375	0.312	1.312
TAN-24	12	4.716	0.0112	4.7048	4.6619	0.0083	4.6536	4.6138	4.5825 ± 0.010	0.156	4.531	1.906	1.093	4.458	0.375	0.312	1.375
TAN-26	12	5.106	0.0112	5.0948	5.0519	0.0083	5.0436	5.0038	4.9725 ± 0.010	0.156	4.906	2.031	1.156	4.844	0.500	0.312	1.438
TAN-128	12	5.497	0.0112	5.4858	5.4429	0.0083	5.4346	5.3948	5.3635 ± 0.010	0.156	5.297	2.656	1.468	5.229	0.625	0.312	1.750
TAN-130	12	5.888	0.01125	5.8768	5.8339	0.0083	5.8256	5.7858	5.7545 ± 0.010	0.156	5.656	2.812	1.562	5.590	0.625	0.375	1.906
TAN-132	8	6.284	0.0152	6.2688	6.2028	0.0091	6.1937	6.1306	6.0993 ± 0.010	0.250	6.062	2.875	1.593	5.956	0.625	0.375	1.938
TAN-134	8	6.659	0.0152	6.6438	6.5778	0.0091	6.5687	6.5056	6.4743 ± 0.010	0.250	6.438	3.000	1.656	6.326	0.750	0.375	2.000
TAN-136	8	7.066	0.0152	7.0508	6.9848	0.0091	6.9757	6.9126	6.8813 ± 0.010	0.250	6.844	3.125	1.718	6.734	0.750	0.375	2.062
TAN-138	8	7.472	0.0152	7.4568	7.3908	0.0091	7.3817	7.3186	7.2873 ± 0.010	0.250	7.250	3.125	1.718	7.141	0.750	0.375	2.062
TAN-140	8	7.847	0.0152	7.8318	7.7658	0.0114	7.7544	7.6936	7.6623 ± 0.010	0.250	7.625	3.312	1.812	7.510	0.875	0.375	2.125

<sup>(1)</sup>This standard is applicable to steel nuts. When either the nut or the shaft is made of stainless steel, aluminum, or other material having a tendency to seize, it is recommended that the maximum thread diameter of the shaft, both major and pitch, be reduced by 20 percent of the listed pitch diameter tolerance.

<sup>(2)</sup>Suggested tolerance on these dimensions of +0.016/-0.000 in.

## CUP SHIMS

### STANDARD METAL SHIMS FOR CUP ADJUSTMENT OF BEARINGS

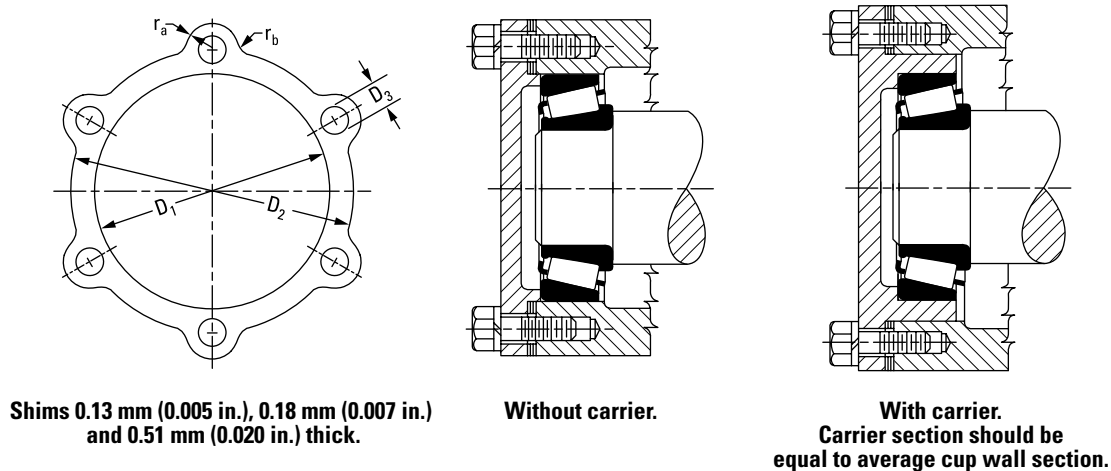


Fig. 57. Cup shims.

Suggested shim sets consist of three 0.13 mm (0.005 in.), three 0.18 mm (0.007 in.) and one 0.51 mm (0.020 in.) thick shims. When ordering, specify the exact quantity for each part number. Shims shown in this table are made from aluminum.

**Cup Shims** – part number identifies the following:

#### EXAMPLE

Shim	Size	Thickness (in.)
K2 K2	00	00
K2 06 05	covers number 6 shim	0.13 mm (0.005 in.) thick
K2 06 07	covers number 6 shim	0.18 mm (0.007 in.) thick
K2 06 20	covers number 6 shim	0.51 mm (0.020 in.) thick

# AUXILIARY PARTS

## CUP SHIMS

Shim Part Numbers			Cap Screws		D <sub>1</sub>	D <sub>2</sub>	D <sub>3</sub>	r <sub>a</sub>	r <sub>b</sub>
0.13 0.005 Thick	0.18 0.007 Thick	0.51 0.020 Thick	No.	Size					
			mm in.	mm in.	mm in.	mm in.	mm in.	mm in.	
K20605	K20607	K20620	4	6.4 0.25	35.8 1.41	47.8 1.88	7.1 0.28	6.4 0.25	3.0 0.12
K20705	K20707	K20720	4	6.4 0.25	45.2 1.78	57.2 2.25	7.1 0.28	6.4 0.25	3.0 0.12
K20805	K20807	K20820	4	9.7 0.38	51.6 2.03	69.8 2.75	10.4 0.41	9.7 0.38	4.8 0.19
K20905	K20907	K20920	4	9.7 0.38	59.4 2.34	76.2 3.00	10.4 0.41	9.7 0.38	4.8 0.19
K21005	K21007	K21020	4	9.7 0.38	65.8 2.59	82.6 3.25	10.4 0.41	9.7 0.38	4.8 0.19
K21105	K21107	K21120	4	9.7 0.38	70.6 2.78	88.9 3.50	10.4 0.41	9.7 0.38	4.8 0.19
K21205	K21207	K21220	4	9.7 0.38	77.0 3.03	95.2 3.75	10.4 0.41	9.7 0.38	4.8 0.19
K21405	K21407	K21420	4	9.7 0.38	89.7 3.53	108.0 4.25	10.4 0.41	9.7 0.38	4.8 0.19
K21505	K21507	K21520	4	9.7 0.38	96.0 3.78	114.3 4.50	10.4 0.41	9.7 0.38	4.8 0.19
K21605	K21607	K21620	4	12.7 0.50	102.4 4.03	127.0 5.00	13.5 0.53	12.7 0.50	6.4 0.25
K21705	K21707	K21720	4	12.7 0.50	108.7 4.28	133.4 5.25	13.5 0.53	12.7 0.50	6.4 0.25
K21805	K21807	K21820	4	12.7 0.50	115.1 4.53	139.7 5.50	13.5 0.53	12.7 0.50	6.4 0.25
K21905	K21907	K21920	6	12.7 0.50	121.4 4.78	146.0 5.75	13.5 0.53	12.7 0.50	6.4 0.25
K22005	K22007	K22020	6	12.7 0.50	127.8 5.03	152.4 6.00	13.5 0.53	12.7 0.50	6.4 0.25
K22205	K22207	K22220	6	12.7 0.50	140.5 5.53	165.1 6.50	13.5 0.53	12.7 0.50	6.4 0.25
K22405	K22407	K22420	6	12.5 0.50	153.2 6.03	177.8 7.00	13.5 0.53	12.7 0.50	6.4 0.25
K22505	K22507	K22520	6	15.7 0.62	159.5 6.28	190.5 7.50	16.8 0.66	15.7 0.62	7.9 0.31

Shim Part Numbers			Cap Screws		D <sub>1</sub>	D <sub>2</sub>	D <sub>3</sub>	r <sub>a</sub>	r <sub>b</sub>
0.13 0.005 Thick	0.18 0.007 Thick	0.51 0.020 Thick	No.	Size					
			mm in.	mm in.	mm in.	mm in.	mm in.	mm in.	
K22605	K22607	K22620	6	15.7 0.62	165.9 6.53	196.8 7.75	16.8 0.66	15.7 0.62	7.9 0.31
K22705	K22707	K22720	6	15.7 0.62	172.2 6.78	203.2 8.00	16.8 0.66	15.7 0.62	7.9 0.31
K22905	K22907	K22920	6	15.7 0.62	184.9 7.28	215.9 8.50	16.8 0.66	15.7 0.62	7.9 0.31
K23005	K23007	K23020	6	15.7 0.62	191.3 7.53	222.2 8.75	16.8 0.66	15.7 0.62	7.9 0.31
K23205	K23207	K23220	6	15.7 0.62	204.0 8.03	235.0 9.25	16.8 0.66	15.7 0.62	7.9 0.31
K23405	K23407	K23420	6	15.7 0.62	216.7 8.53	247.6 9.75	16.8 0.66	15.7 0.62	7.9 0.31
K23605	K23607	K23620	6	15.7 0.62	229.4 9.03	260.4 10.25	16.8 0.66	15.7 0.62	7.9 0.31
K23805	K23807	K23820	6	15.7 0.62	242.1 9.53	273.0 10.75	16.8 0.66	15.7 0.62	7.9 0.31
K24005	K24007	K24020	6	19.0 0.75	254.8 10.03	292.1 11.50	19.8 0.78	19.0 0.75	9.7 0.38
K24105	K24107	K24120	8	19.0 0.75	267.5 10.53	304.8 12.00	19.8 0.78	19.0 0.75	9.7 0.38
K24205	K24207	K24220	8	19.0 0.75	296.2 11.66	333.2 13.12	19.8 0.78	19.0 0.75	9.7 0.38
K24405	K24407	K24420	8	19.0 0.75	318.3 12.53	355.6 14.00	19.8 0.78	19.0 0.75	9.7 0.38
K24605	K24607	K24620	8	22.4 0.88	343.7 13.53	387.4 15.25	23.9 0.94	22.4 0.88	11.2 0.44
K24805	K24807	K24820	8	22.4 0.88	369.1 14.53	412.8 16.25	23.9 0.94	22.4 0.88	11.2 0.44
K25005	K25007	K25020	8	25.4 1.00	394.5 15.53	444.5 17.50	26.9 1.06	25.4 1.00	12.7 0.50
K25205	K25207	K25220	8	25.4 1.00	419.9 16.53	469.9 18.50	26.9 1.06	25.4 1.00	12.7 0.50

THESE PARTS HAVE BEEN DESIGNED AND DEVELOPED FOR USE WITH TIMKEN BEARINGS ONLY.

## CONE SHIMS

### STANDARD METAL SHIMS FOR CONE ADJUSTED BEARINGS

Suggested shim sets consist of three 0.13 mm (0.005 in.), three 0.18 mm (0.007 in.) and one 0.51 mm (0.020 in.) thick shims.

When ordering, specify the exact quantity for each part number.

Shims shown in this table are made from aluminum, brass or steel shim stock.

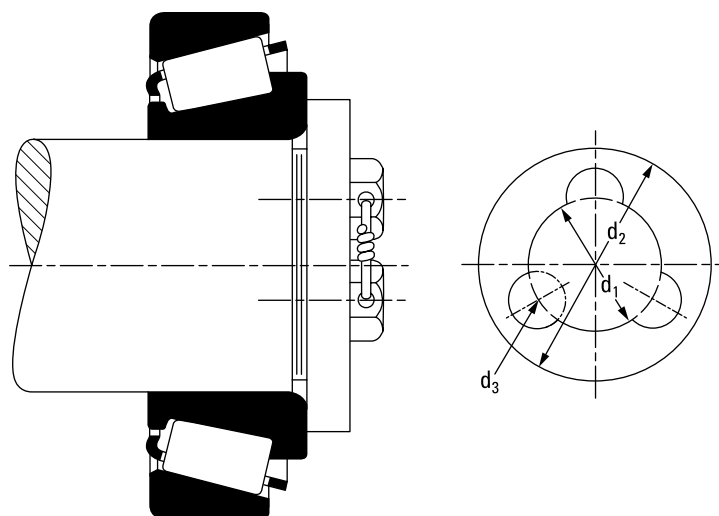


Fig. 58. Cone shims.

Shims		Shaft	Cap Screws		d <sub>1</sub>	d <sub>2</sub>	d <sub>3</sub>
Part Number	Thickness	Size	No.	Size	d <sub>1</sub>	d <sub>2</sub>	d <sub>3</sub>
	mm in.	mm in.		mm in.	mm in.	mm in.	mm in.
T50605	0.13 0.005	63.5 2.50	3	12.7 0.50	35.1 1.38	60.5 2.38	14.2 0.56
T50606	0.18 0.007	to					
T50607	0.51 0.020	73.2 2.88					
T50608	0.13 0.005	76.2 3.00	3	12.7 0.50	44.4 1.75	73.2 2.88	14.2 0.56
T50609	0.18 0.007	to					
T50610	0.51 0.020	85.9 3.38					
T50611	0.13 0.005	88.9 3.50	3	12.7 0.50	57.2 2.25	85.9 3.38	14.2 0.56
T50612	0.18 0.007	to					
T50613	0.51 0.020	104.6 4.12					
T45882	0.13 0.005	108.0 4.25	3	15.7 0.62	76.2 3.00	103.1 4.06	17.5 0.69
T50633	0.18 0.007	to					
T45884	0.51 0.020	117.3 4.62					
T45885	0.13 0.005	120.6 4.75	3	15.7 0.62	88.9 3.50	117.3 4.62	17.5 0.69
T50634	0.18 0.007	to					
T45887	0.51 0.020	124.0 4.88					

Shims		Shaft	Cap Screws		d <sub>1</sub>	d <sub>2</sub>	d <sub>3</sub>
Part Number	Thickness	Size	No.	Size	d <sub>1</sub>	d <sub>2</sub>	d <sub>3</sub>
	mm in.	mm in.		mm in.	mm in.	mm in.	mm in.
T50614	0.13 0.005	127.0 5.00	4	19.0 0.75	88.9 3.50	124.0 4.88	20.6 0.81
T50615	0.18 0.007	to					
T50616	0.51 0.020	136.7 5.38					
T50617	0.13 0.005	139.7 5.50	4	19.0 0.75	88.9 3.50	136.7 5.38	20.6 0.81
T50618	0.18 0.007	to					
T50619	0.51 0.020	149.4 5.88					
T50620	0.13 0.005	152.4 6.00	6	19.0 0.75	101.6 4.00	149.4 5.88	20.6 0.81
T50621	0.18 0.007	to					
T50622	0.51 0.020	174.8 6.88					
T50623	0.13 0.005	177.8 7.00	6	25.4 1.00	127.0 5.00	174.8 6.88	26.9 1.06
T50624	0.18 0.007	to					
T50625	0.51 0.020	200.2 7.88					
T50626	0.13 0.005	203.2 8.00	6	31.8 1.25	152.4 6.00	200.2 7.88	33.3 1.31
T50627	0.18 0.007						
T50628	0.51 0.020						

THESE PARTS HAVE BEEN DESIGNED AND DEVELOPED FOR USE WITH TIMKEN BEARINGS ONLY.







To view more Timken catalogs, go to [www.timken.com/catalogs](http://www.timken.com/catalogs) for interactive versions, or to download a catalog app for your smart phone or mobile device scan the QR code or go to [timkencatalogs.squawqr.com](http://timkencatalogs.squawqr.com).

# TIMKEN

The Timken team applies their know-how to improve the reliability and performance of machinery in diverse markets worldwide. The company designs, makes and markets high-performance mechanical components, including bearings, gears, belts, chain and related mechanical power transmission products and services.

[www.timken.com](http://www.timken.com)

Price: USD \$75

Stronger Commitment. Stronger Value. Stronger Worldwide. Stronger Together. | Stronger By Design.